

Accessories for digital drive systems with S300/S400/S600/S700

Manual



Edition: July 2019

Translation of the original document

European Version (CE region)



For safe and proper use, follow
these instructions.
Keep them for future reference.

KOLLMORGEN

Because Motion Matters™

Record of Document Revisions

Edition	Comments
10/2017	Links changed from WIKI to KDN, recommended cable types (AC, RBext, DC-Bus) corrected
02/2018	Trademark list added, SpeedTec spelling corrected
07/2019	Warning notes layout updated, user expertise updated, new readers note cover page, S640/670 removed, mains filter removed.

Trademarks

- EnDat is a registered trademark of Dr. Johannes Heidenhain GmbH
- EtherCAT is a registered trademark and patented technology, licensed by Beckhoff Automation GmbH
- sercos® is a registered trademark of sercos® international e.V.
- HIPERFACE is a registered trademark of Max Stegmann GmbH
- SpeedTec is a registered trademark of TE Connectivity Industrial GmbH
- Windows is a registered trademark of Microsoft Corporation

Technical changes which improve the performance of the device may be made without prior notice!

This document is the intellectual property of Kollmorgen. All rights reserved. No part of this work may be reproduced in any form (by photocopying, microfilm or any other method) or stored, processed, copied or distributed by electronic means without the written permission of Kollmorgen.

1 Table of Contents

1 Table of Contents	3
2 General	5
2.1 About this manual	5
2.2 Hints for the online edition (PDF format)	5
2.3 Symbols Used	6
2.4 Safety Notes	7
3 Digital Drive Systems	8
3.1 Drive System with S300	8
3.2 Drive System with S400	9
3.3 Drive System with S601...620	10
3.4 Drive System with S701...724	11
3.5 Drive System with S748/772	12
4 Mechanical Accessories	13
4.1 Mounting Kit for AKMH Motors	13
4.2 Suspension Unit for AKM motors	13
4.3 Fan Kit for AKM7 motors	14
4.4 Shield clamps	15
4.4.1 Auxiliary terminals on the servo amplifier	15
4.4.2 External shielding busbar	16
5 Mains chokes	17
5.1 General	17
5.2 Important notes	17
5.3 Type assignment and order codes	17
5.4 Mains choke 3L	18
6 Brake resistors	19
6.1 General	19
6.2 Important notes	19
6.3 Type assignment and order codes	20
6.4 External brake resistor BAFP(U)	21
6.5 External brake resistor BAR(U)	22
6.6 External brake resistor BAS(U)	23
7 Capacitor Modules	24
7.1 General	24
7.2 Important notes	24
7.3 Type assignment and order codes	25
7.4 Installation example	25
7.5 KCM Module	26
8 Motor chokes	27
8.1 General	27
8.2 Important notes	28
8.3 Type assignment and order codes	28
8.4 Motor choke 3YL-24	29
8.5 Motor choke 3YLN-xx	30
9 Cables	31
9.1 Technical data for cables	31
9.2 Tools	31
9.3 PC connection	32
9.4 Power Voltage Supply, external brake resistor, DC bus link	34
9.4.1 Recommended cable type	34
9.4.2 Mating connector (part of delivery)	34

9.4.3 Mating connector (optional)	34
9.4.4 Preparing cables for S300/S400/S601...620/S701...724	35
9.4.5 Preparing cables for S748/772	37
9.5 24V auxiliary voltage supply	38
9.5.1 Mating connector (part of delivery)	38
9.5.2 Recommended cable type	38
9.5.3 Preparing cables	39
9.6 Digital/analog Inputs/Outputs	40
9.7 Encoder Emulation, Stepper motor control, Master-Slave	42
9.7.1 Mating connector, cable type	42
9.7.2 Connection	42
9.7.3 Termination resistors	42
9.7.4 Preparing cables	43
9.8 CAN bus cable	44
9.9 Motor Hybrid Cables	46
9.9.1 Single (hybrid) motor cables for AKM1 Motor (i-tec connector)	46
9.9.2 Single (hybrid) motor cables for AKM2-6 (M23/SpeedTec)	47
9.9.2.1 With shield clamp	47
9.9.2.2 With shield plate	47
9.10 Motor Power Cables	48
9.10.1 General	48
9.10.2 Motor cables, configured	48
9.10.2.1 Order codes motor cables for S303, S306, S310 (115/230V)	49
9.10.2.2 Order codes motor cables for S341, S343, S346 (400/480V)	50
9.10.2.3 Order codes motor cables for S400	51
9.10.2.4 Order codes motor cables for S601...620	52
9.10.2.5 Order codes motor cables for S701-712	53
9.10.2.6 Order codes motor cables for S724	55
9.10.2.7 Order codes motor cables for S748/772	55
9.10.3 Preparing motor cables (motor end)	57
9.10.3.1 Motor series AKM1...8, 6SMx7, DBL2...6, DBK with Y-Tec, M23, or M40 connector	57
9.10.3.2 Motor series AKM8, DBL7/8 with terminal box	57
9.10.4 Preparing motor cables (servo amplifier end)	59
9.10.4.1 Preparing cables for S300/S400	59
9.10.4.2 Preparing cables for S601...620	60
9.10.4.3 Preparing cables for S701...724	61
9.10.4.4 Preparing cables for S748/772	61
9.11 Motor Feedback Cables	63
9.11.1 Resolver cables	63
9.11.2 Encoder cables	64
9.11.3 ComCoder cables	65

2 General

2.1 About this manual

This manual describes accessories for Kollmorgen S300/S400/S600/S700 amplifiers. It contains essential technical data. The manual is only valid in conjunction with the instructions manual for the servo amplifier and servo motor you are using in your application.

You will find copies of the instructions manual for Kollmorgen servo amplifiers and servo motors on the CD ROM included in the scope of supply and on our Internet site. The documents are available in Acrobat Reader format in multiple languages (system requirements: WINDOWS, Internet browser, Acrobat Reader).

Servo amplifier product family names appear in abbreviated format:

Servo amplifier	Abbreviation
SERVOSTAR 300	S300
SERVOSTAR 400	S400
SERVOSTAR 601...620	S601...620

More detail information can be found in the "European Kollmorgen Developer Network" available at <http://kdn.kollmorgen.com>.







2.2 Hints for the online edition (PDF format)

Bookmark: Table of contents and index are active bookmarks.

Table of contents and index in the text: The lines are active cross references. Click on the desired line and the appropriate page is indicated.

Page/chapter numbers in the text: Page/chapter numbers with cross references are active. Click at the page/chapter number to reach the indicated target.

2.3 Symbols Used

Symbol	Indication
 DANGER	Indicates a hazardous situation which, if not avoided, will result in death or serious injury.
 WARNING	Indicates a hazardous situation which, if not avoided, could result in death or serious injury.
 CAUTION	Indicates a hazardous situation which, if not avoided, could result in minor or moderate injury.
NOTICE	Indicates situations which, if not avoided, could result in property damage.
NOTE	This symbol indicates important notes.
	Warning of a danger (general). The type of danger is specified by the text next to the symbol.
	Warning of danger from electricity and its effects.
	Warning of danger from hot surface.
	Warning of danger from suspended loads.

2.4 Safety Notes

This section helps you to recognize and avoid dangers to people and objects.

Read the documentation!

Read the available documentation before installation and commissioning. Improper handling of the devices can cause harm to people or damage to property. The operator must therefore ensure that all persons entrusted to work on the devices have read and understood the manual and that the safety notices in this manual are observed.

Always observe the whole drive system built with servo amplifier, cables, motor, accessories (filters, chokes, etc.). This means, that all documentation which exist for the components, must be available, must be read and must be understood.

Pay attention to the technical data!

Adhere to the technical data and the specifications on connection conditions (rating plate and documentation). If permissible voltage values or current values are exceeded, the devices can be damaged, e.g. through overheating.

Specialist staff required!

Only properly qualified personnel are permitted to perform such tasks as transport, installation and setup. Qualified specialist staff are persons with expertise in transport, installation, assembly, commissioning and operation of electrotechnical equipment.

- Transport, storage, unpacking: only by personnel with knowledge of handling electrostatically sensitive components.
- Mechanical installation: only by personnel with mechanical expertise.
- Electrical installation: only by personnel with expertise in electrical engineering.
- Basic tests / setup: only by personnel with expertise in electrical engineering and drive technology.

The qualified personnel must know and observe ISO 12100 / IEC 60364 / IEC 60664 and national accident prevention regulations.

Additional requirements on specialist staff may also result from the risk assessment.

Hot surface!



Some devices can reach temperatures of up to 250°C during operation. Touching them can result in burns. Observe the permissible mounting position and ensure that a sufficient distance is maintained from neighboring assemblies.

Earthing!



It is vital that you ensure that the device housing is safely earthed to the PE (protective earth) busbar in the switch cabinet. Without low-resistance earthing no personal protection can be guaranteed and there is a risk of death from electric shock.

High voltages!



Keep the switching cabinet closed when the equipment is in operation. Not having optical displays does not guarantee an absence of voltage. Power connections may carry voltage even if the motor is not turning.

Do not unplug any connectors during operation. There is a risk of death or severe injury from touching exposed contacts. Power connections may be live even when the motor is not rotating. This can cause flashovers with resulting injuries to persons and damage to the contacts.

DC Bus link connections can carry dangerous voltage levels over an hour after the line voltage has been switched off (self-discharge time). Danger of death from electric shock.

Before commencing work on the modules' power terminals, check the voltage at the connection terminals is de-energized to ground and to each other.

3 Digital Drive Systems

The systems shown are simply a possible scenario for setting up a digital drive system with relevant servo amplifier components.

3.1 Drive System with S300

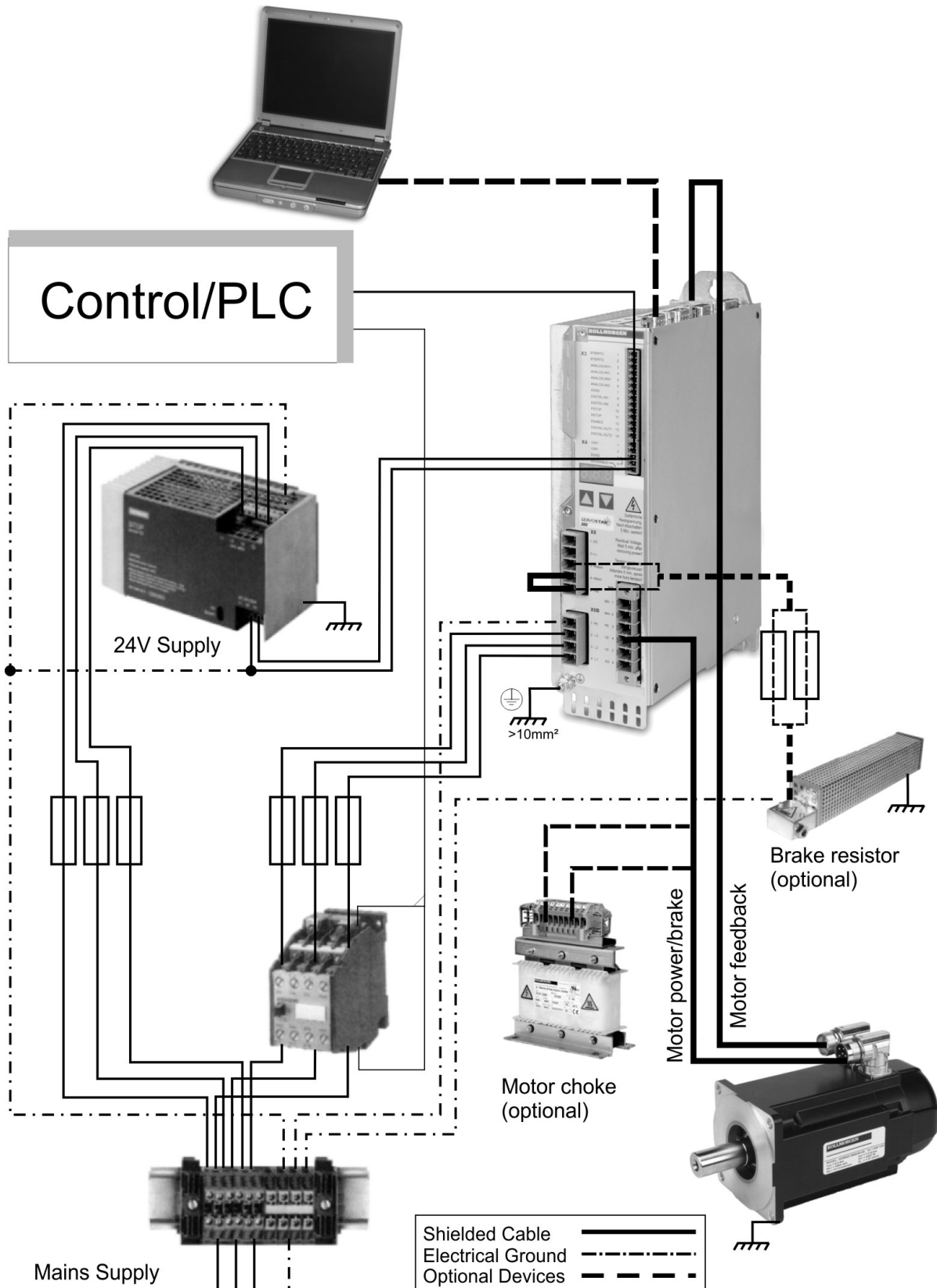

3.2 Drive System with S400

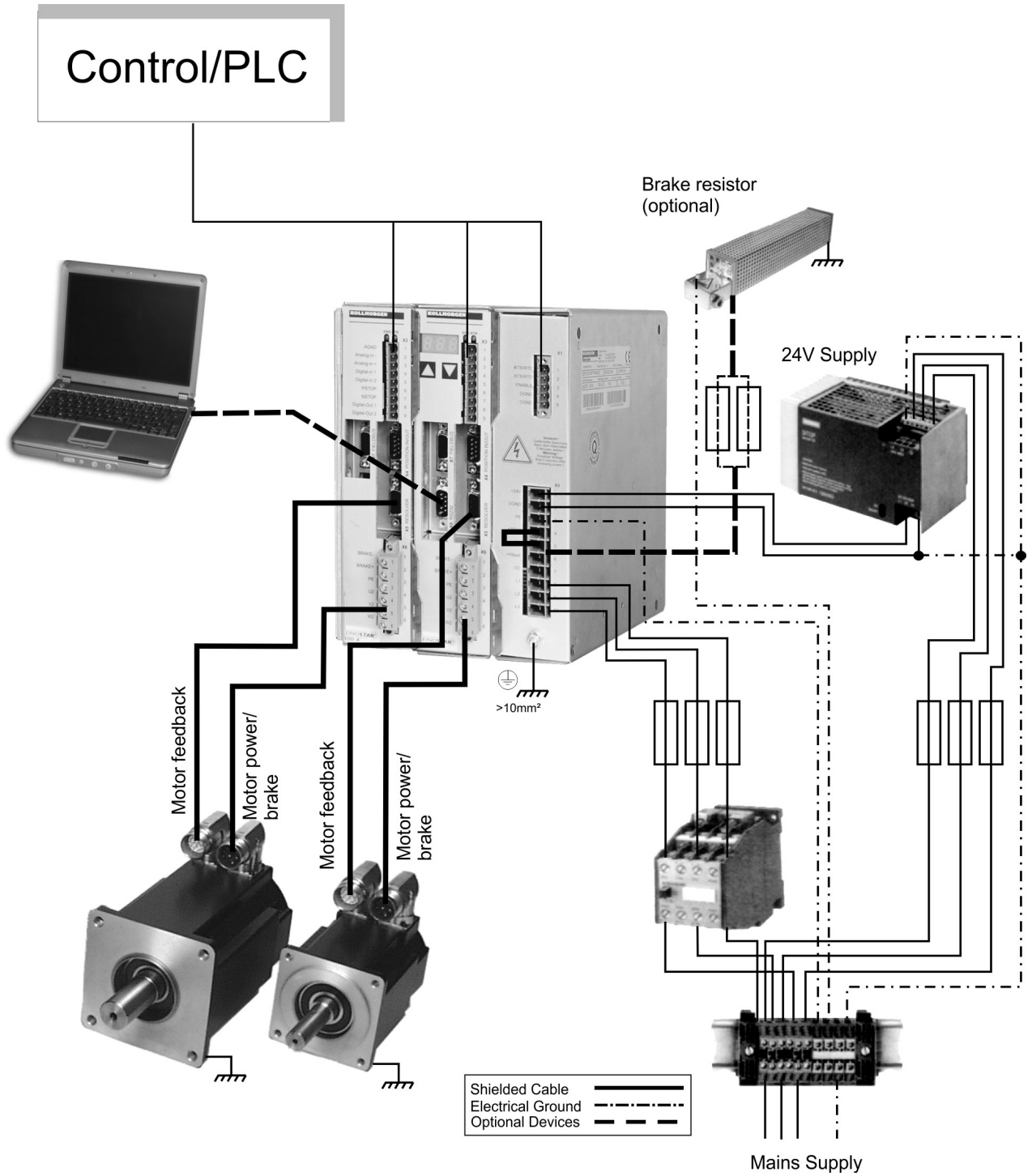

3.3 Drive System with S601...620

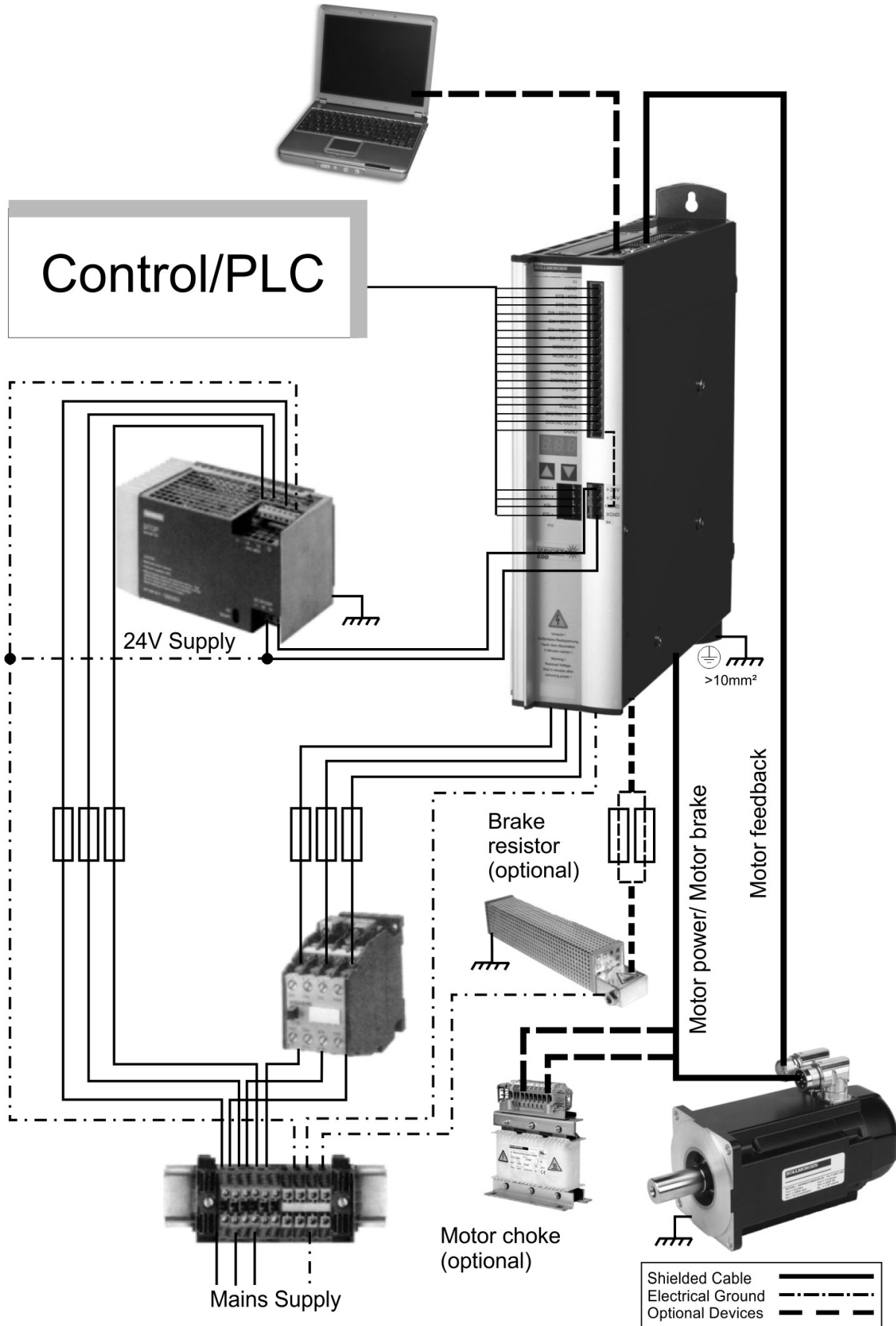

3.4 Drive System with S701...724

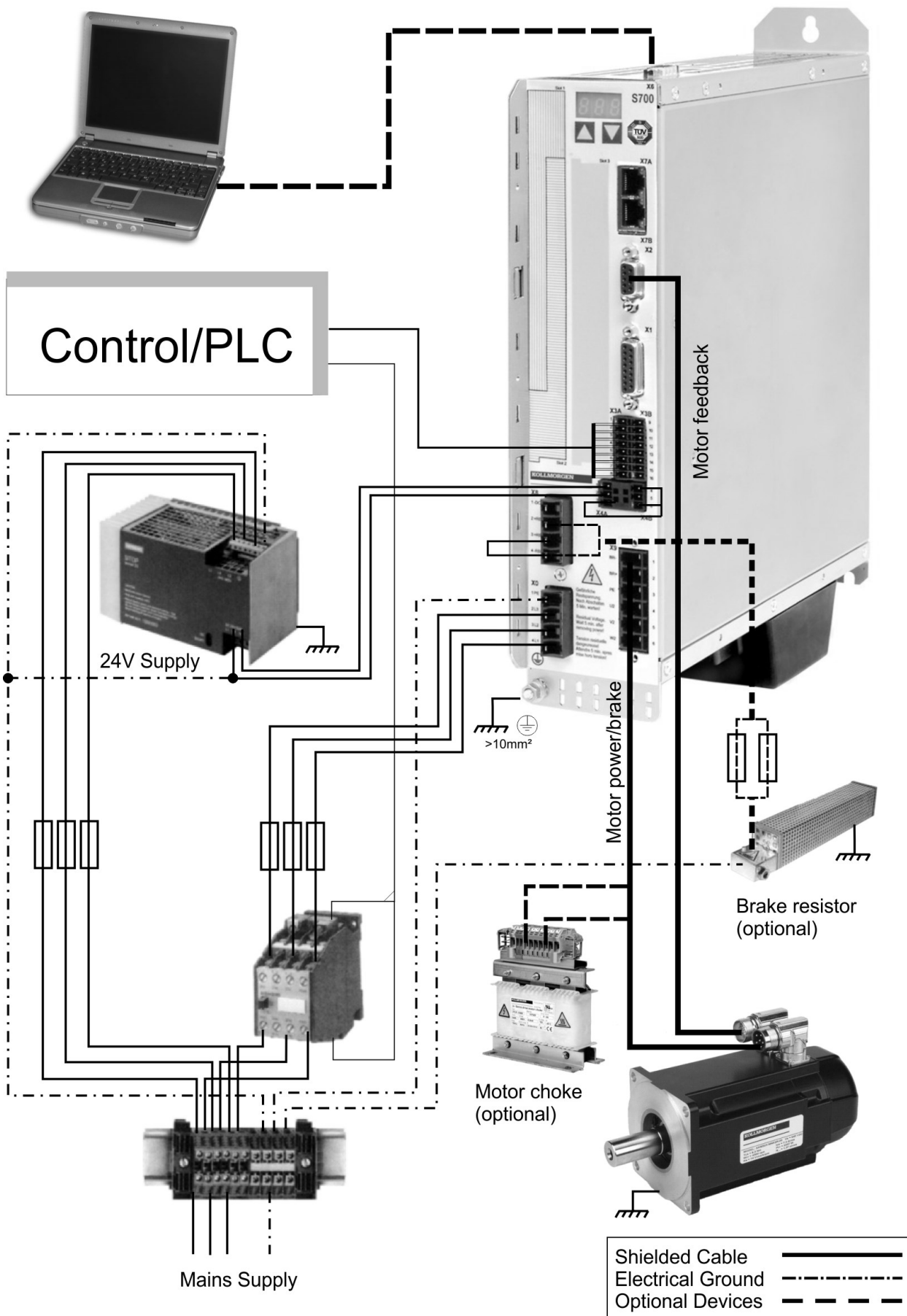

3.5 Drive System with S748/772

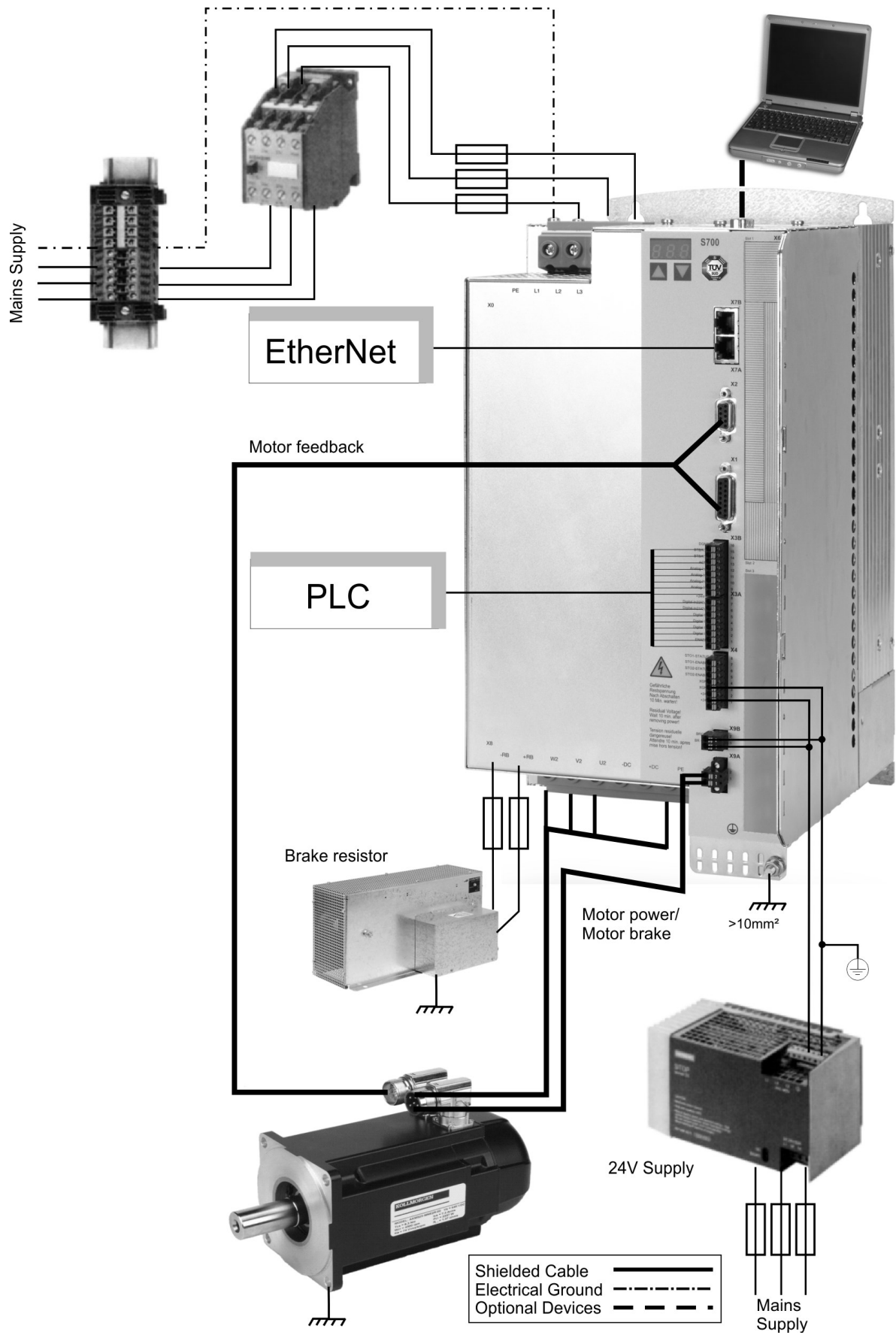

4 Mechanical Accessories

4.1 Mounting Kit for AKMH Motors

IEC mounting kits with 1 shaft center screw and 4 flange screws. Hygienic mounting is possible only with these screws.

Description	Order Code
Mounting Hardware AKMH2, Ax flange / Cx front mounting	MTG-KIT-AKMH2-IEC
Mounting Hardware AKMH3, Ax flange / Cx front mounting	MTG-KIT-AKMH3-IEC
Mounting Hardware AKMH4, Ax flange / Cx front mounting	MTG-KIT-AKMH4-IEC
Mounting Hardware AKMH5, Ax flange / Cx front mounting	MTG-KIT-AKMH5-IEC
Mounting Hardware AKMH6, Ax flange / Cx front mounting	MTG-KIT-AKMH6-IEC

NEMA mounting kits are described in the US selection guide, available from the Kollmorgen website (www.kollmorgen.com).

4.2 Suspension Unit for AKM motors



WARNING Suspended load!

Risk of death if load falls.

- Never step under the load, while the motor is raised!

NOTICE

You must read the instructions manual for the suspension unit ZPMZ 120/292. Observe the "safety instructions" and "use as directed" hints before starting transportation work.

The Suspension Unit ZPMZ 120/292 is designed for suspended handling exclusively of motors (i.e., without attached units such as gearboxes, clutches, etc.) with a maximum weight of 120 kg and maximum nominal span of the extreme suspension hooks of 292 mm.

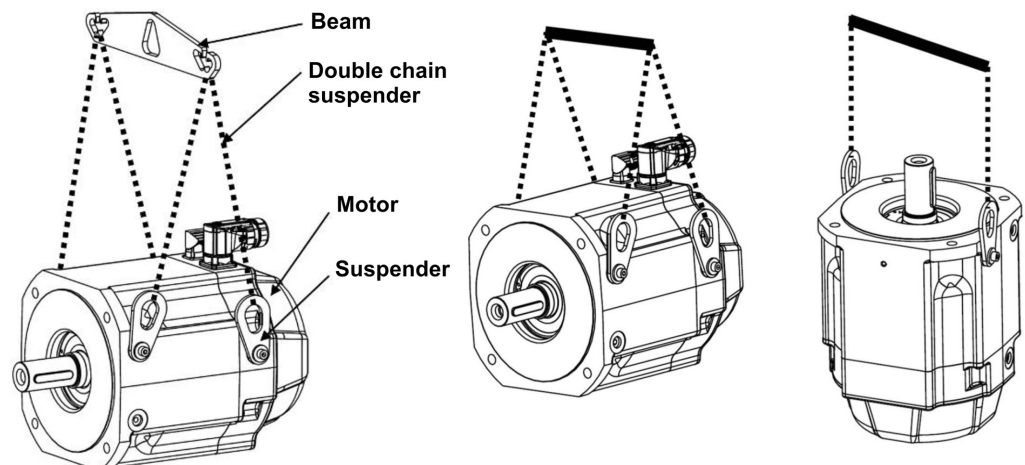

The suspended unit consists of a Beam, suspended off the crane hook and two double-run chain suspenders. The motor may be borne on two or four runs of the chain suspender.

The suspenders (number depends on the motor type) are delivered with the motor.

Technical Data				
Lifting capacity	120 kg		Weight	0,83 kg
Nominal span	292 mm		Number of cycles a year	20.000
Lug width	44,7 mm		Average load	60 %
Lug height	51 mm		Order code	FA00092

4.3 Fan Kit for AKM7 motors

NOTICE

Observe the mounting instructions delivered with the fan kit. The fan housing can be mounted either with both the supplied brackets and spacers or with the brackets only. The choice of mounting method depends on the application. If strong vibrations are expected, you should use both brackets and spacers. Motors with integrated brakes require the long spacers.

Mounting the fan kit enlarges the motor by approximately 65 mm. The detailed final dimensions of AKM7 motors with mounted fan kit can be found in the instructions manual of the AKM motor series. Ventilation of AKM7 motors allow increased current of the motors. This higher current usually requires larger wiring cross section compared to not ventilated motors. The necessary data for current and wiring cross section can be found in the technical data section of the AKM instructions manual.

Technical Data	
Supply voltage	24 VDC
Supply current	270 mA
Electrical power	6.5 W
Surface	Coated with polyester powder coating in matt black, not resistant against solvents
Protection class	IP 20
Connection	Cable gland 10 mm, cable diameter 4 mm to 6 mm, recommended cable 3x0.75 mm ² (not part of delivery)
Terminals	0.33 mm ² to 4 mm ²
Weight	2.52 kg
Order code	AKM7-FAN

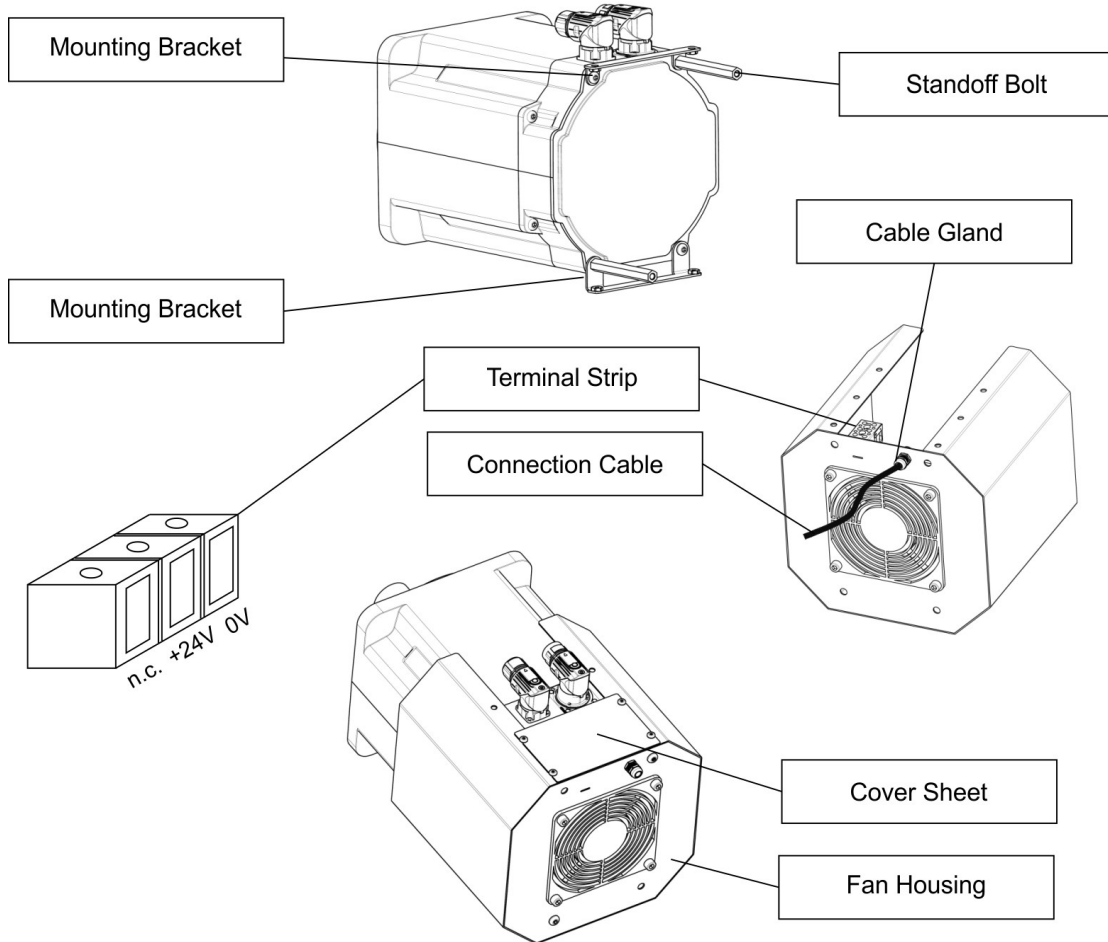

4.4 Shield clamps

NOTICE

You must read the instructions manuals for the servo amplifier/servo motor you are using in your application. Observe the safety instructions they contain before commencing mounting/installation work.

4.4.1 Auxiliary terminals on the servo amplifier

S300, S701...724



These servo amplifiers feature slots on the front panel for the connection of additional shield clamps.

Article	Tension range	Order Codes
SK14	6-13mm	DE-108248

S748/772



The shroud supplied with these servo amplifiers features slots for the connection of additional shield clamps.

We recommend using the following shield clamp:

Manufacturer	Article	Tension range
OBO (Bettermann)	BBS-Schelle Typ 2056	16-22mm
OBO (Bettermann)	BBS-Schelle Typ 2056	28-34mm

The clamps are part of delivery of the servo amplifier.

4.4.2 External shielding busbar



The power cable shields (line in, motor cable, external regen resistor) can be routed to an additional busbar via shield clamps.

Kollmorgen recommends using Weidmüller KLBÜ shield clamps.

A possible scenario for setting up a busbar for the above shield clamps is described below.

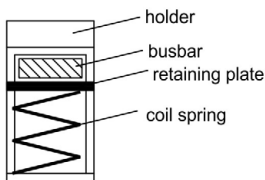
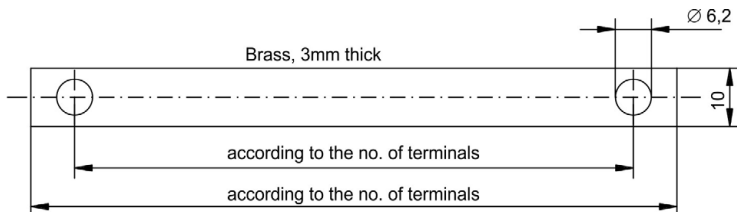

1. Cut a busbar of the required length from a brass rail (cross-section 10 x 3 mm) and drill holes in it as indicated. All shield clamps required must fit between the drill holes.

CAUTION

Risk of injury due to the spring force of the coil spring.
Use pincers.

2. Squeeze together the coil spring and the supporting plate and push the busbar through the opening in the holder.

3. Mount the busbar with the shield clamps fitted on the assembly plate. Use either metal spacer bushes or screws with nuts and accessories to maintain a spacing of 50 mm. Earth the busbar using a single conductor with a cross-section of at least 2.5 mm².

4. Strip the external cable sheath to a length of approx. 30 mm, taking care not to damage the braided shield. Push the shield clamp up and route the cable to it via the busbar.

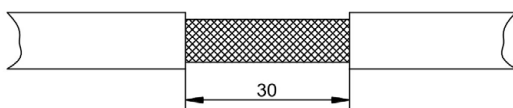
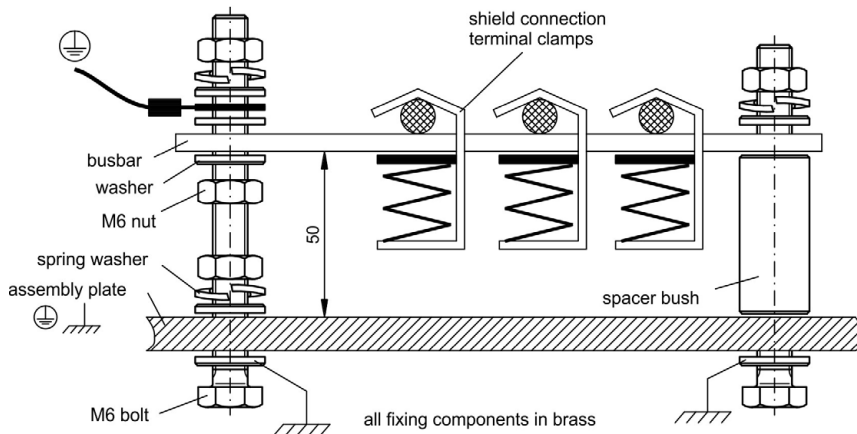

NOTICE

Make sure there is good contact between the shield clamp and the braided shield.

5 Mains chokes

5.1 General

In special cases, if mains voltage is more than 3% asymmetrical, then the S748/772 must be used with a mains choke. In unfavorable combination of mains impedance and DC bus capacitance the unloaded DC bus may reach voltage up to 800V without choke. For EMC reasons the chokes should be mounted isolated to the cabinet. Single conductors can be used for wiring, shielded cables are not required. More information can be found on our "European Kollmorgen Developer Network" "[Mains Choke](#)". Purpose of mains choke:

- Prevents impermissible loading of semiconductors in the event of rapid current rise during commutation.
- Prevents voltage dips in the mains voltage caused by commutation.
- Reduces current ripple in the DC link, thereby increasing the service life of the DC link capacitors.

5.2 Important notes



⚠ DANGER High Voltage up to 480 V!

Risk of electric shock. Power terminals are capable of conducting hazardous voltage up to 10 minutes after the mains voltage has been disconnected.

- Before starting work on power terminals, check that the phase-to-earth and phase-to-phase voltages have de-energised.

NOTICE

Due to the high earth leakage currents induced by the system, you should observe the requirements of EN 61800-5-1 (e.g. fixed installation, $\geq 10 \text{ mm}^2$ or double protective earth) when carrying out mounting and installation work. You must read the instructions manual for the servo amplifier/servo motor you are using in your application and observe the safety instructions they contain before commencing mounting/installation work.

Mounting: 50mm free space required above and below the device.

Connection diagram: see servo amplifier instructions manual.

5.3 Type assignment and order codes

Servo amplifier	Mains choke
S748/772 (with asymmetrical mains >3% only)	2% uk
S300, S400, S601...620, S701...724	not required

Order Codes

Article	uk	Order codes
Mains choke 3L0,24-50-2 (0.24mH, 50A)	2%	DE-201476
Mains choke 3L0,2-75-2 (0.20mH, 75A)	2%	DE-201477

5.4 Mains choke 3L

NOTICE

A number of servo amplifiers can be connected to one and the same mains choke; the rated current of the mains choke must be greater than or at least equal to the total current of the connected servo amplifiers.

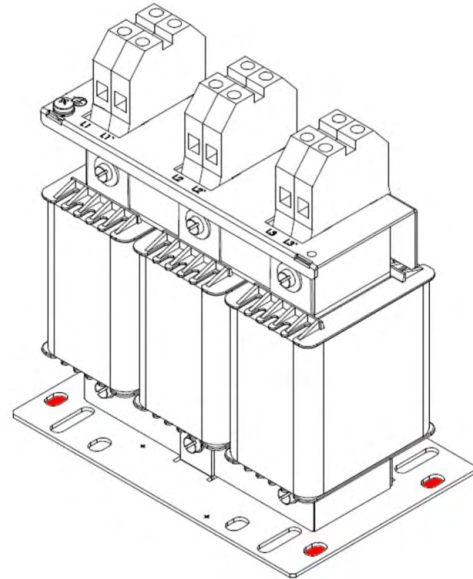
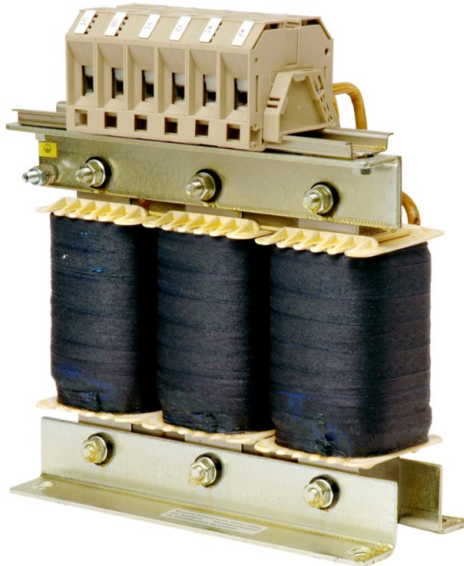
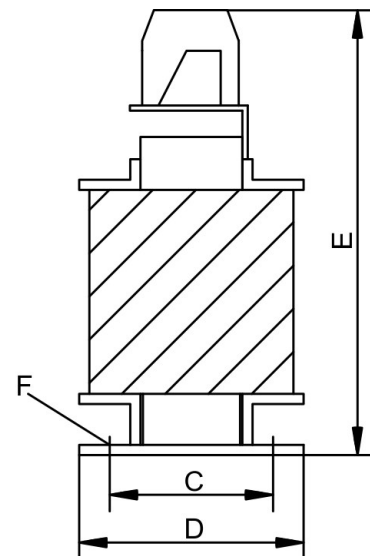
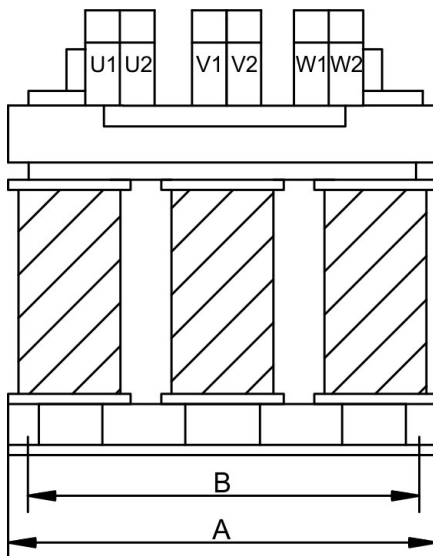

Photo: 3L0,2-160-4, all models are similar



Technical Data

Type	Inductivity [mH]	Nominal Current [A]	uk [%]	A [mm]	B [mm]	C [mm]	D [mm]	E [mm]	F [mm]	Terminals [mm ²]	Weight [kg]
3L 0,5-63-4	0.47	63	4	185	170	77	122	215	8x12	16	9.65
3L 0,4-80-4	0.37	80	4	210	175	85	125	240	8x12	16	12.5
3L 0,2-160-4	0.19	160	4	291	273	116.5	148.5	310	10x18	95	27
3L 0,24-50-2	0.24	50	2	152.5	114.3	88.9	114.3	163	6.5	10	5.9
3L 0,2-75-2	0.20	75	2	185	170	77	122	220	8x12	35	9.9

6 Brake resistors

6.1 General

During braking with the aid of the motor, energy is fed back into the servo amplifier. This regenerative energy is dissipated as heat in the brake resistor. The brake resistor is switched on by the brake circuit. Different resistance values have to be used depending on the servo amplifier. All resistors meet the requirements of CE directives and are UL-registered.

Hints for calculation of the brake power can be found in our Kollmorgen Developer Network on page "[Calculation of brake power](#)", more information to the resistors are given on KDN page "[Brake Resistors](#)".

6.2 Important notes



DANGER High Voltage up to 900 V!

Risk of electric shock. Power terminals are capable of conducting hazardous voltage up to 10 minutes after the mains voltage has been disconnected.

- Before starting work on power terminals, check that the phase-to-earth and phase-to-phase voltages have de-energised.



WARNING High Temperature!

Risk of burns. The brake resistor surface temperature can exceed 250°C.

- Measure the temperature and wait until temperature dropped down below 40°C, before touching the resistor housing.
- Use fusing elements (for example Frizlen FPS series) to switch off the resistor in case of overload current.

NOTICE

Inadequate levels of cooling air or incorrect installation can lead to overheating and destruction of the resistor and surrounding components.

- May only be installed in switchgear cabinets, comply with the permissible installation types and clearances (see dimensional drawing).
- Ensure there is unobstructed convection for cooling purposes.
- Use temperature-resistant materials in the vicinity of the resistor.
- The connection terminals must never be located within the flow range of the heated waste air.

The following requirements must be met to ensure the brake resistors work properly:

- Compliance with required installation clearances
- Compliance with permissible installation type
- Unhindered access of cooling air
- Unhindered diverting of warmed up air
- Rated data with maximum ambient temperature 40°C, in case of ambient temperature higher than 40°C, power must be reduced by 4% per 10K temperature rise

NOTICE

You must read the instructions manual for the servo amplifier/servo motor you are using in your application and observe the safety instructions they contain before commencing mounting/installation work.

A connection diagram appears in the servo amplifier's instructions manual.

6.3 Type assignment and order codes

Servo amplifier	Brake resistor	Resistance/ Ω	Remarks
S300 (S3xx61)	BAR(U)	66	optional
S300 (S3xx01)	BAR(U)	91	optional
S400, S601...620, S701-712	BAFP(U), BAR(U), BAS(U)	33	optional
S748	BAS(U)	15	usually required
S772	BAS(U)	10	usually required
S724	BAR(U), BAS(U)	23	optional

Order codes

Article	Amplifier	Resistance [Ω]	Rated Power [W]	Max. Power [W]	Order code
Brake resistor BAS(U) 2000-10	S772	10	2000	3200	DE-103874
Brake resistor BAS(U) 3000-10		10	3000	4800	DE-103875
Brake resistor BAS(U) 6000-10		10	6000	9600	DE-103876
Brake resistor BAR(U) 500-15	S748	15	500	800	DE-201439
Brake resistor BAR(U) 1000-15		15	1000	1600	DE-201440
Brake resistor BAS(U) 2000-15		15	2000	3200	DE-103871
Brake resistor BAS(U) 3000-15		15	3000	4800	DE-103872
Brake resistor BAS(U) 6000-15	S724	15	6000	9600	DE-103873
Brake resistor BAR(U) 600-23		23	600	960	DE-200613
Brake resistor BAR(U) 1000-23		23	1000	1600	DE-200614
Brake resistor BAS(U) 2000-23		23	2000	3200	DE-200615
Brake resistor BAS(U) 3000-23		23	3000	4800	DE-200616
Brake resistor BAS(U) 4000-23		23	4000	6400	DE-200617
Brake resistor BAFP(U) 100-33		S400, S601...620, S701-712	33	100	160
Brake resistor BAFP(U) 200-33	33		200	320	DE-201438
Brake resistor BAR(U) 250-33	33		250	400	DE-106254
Brake resistor BAR(U) 500-33	33		500	800	DE-106255
Brake resistor BAR(U) 1500-33	33		1500	2400	DE-106258
Brake resistor BAS(U) 3000-33	33		3000	4800	DE-201407
Brake resistor BAR(U) 300-66	S300 (S3xx61)	66	300	480	DE-107161
Brake resistor BAR(U) 600-66		66	600	960	DE-107162
Brake resistor BAR(U) 1000-66		66	1000	1600	DE-107163
Brake resistor BAR(U) 300-91	S300 (S3xx01)	91	300	480	DE-107164
Brake resistor BAR(U) 600-91		91	600	960	DE-107165
Brake resistor BAR(U) 1000-91		91	1000	1600	DE-107166

6.4 External brake resistor BAFP(U)



Protection class: IP40



WARNING

The surface temperature can exceed 250°C. Risk of burns and fire! Measure the temperature before touching.

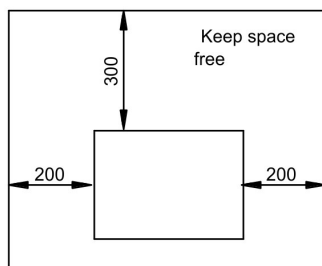
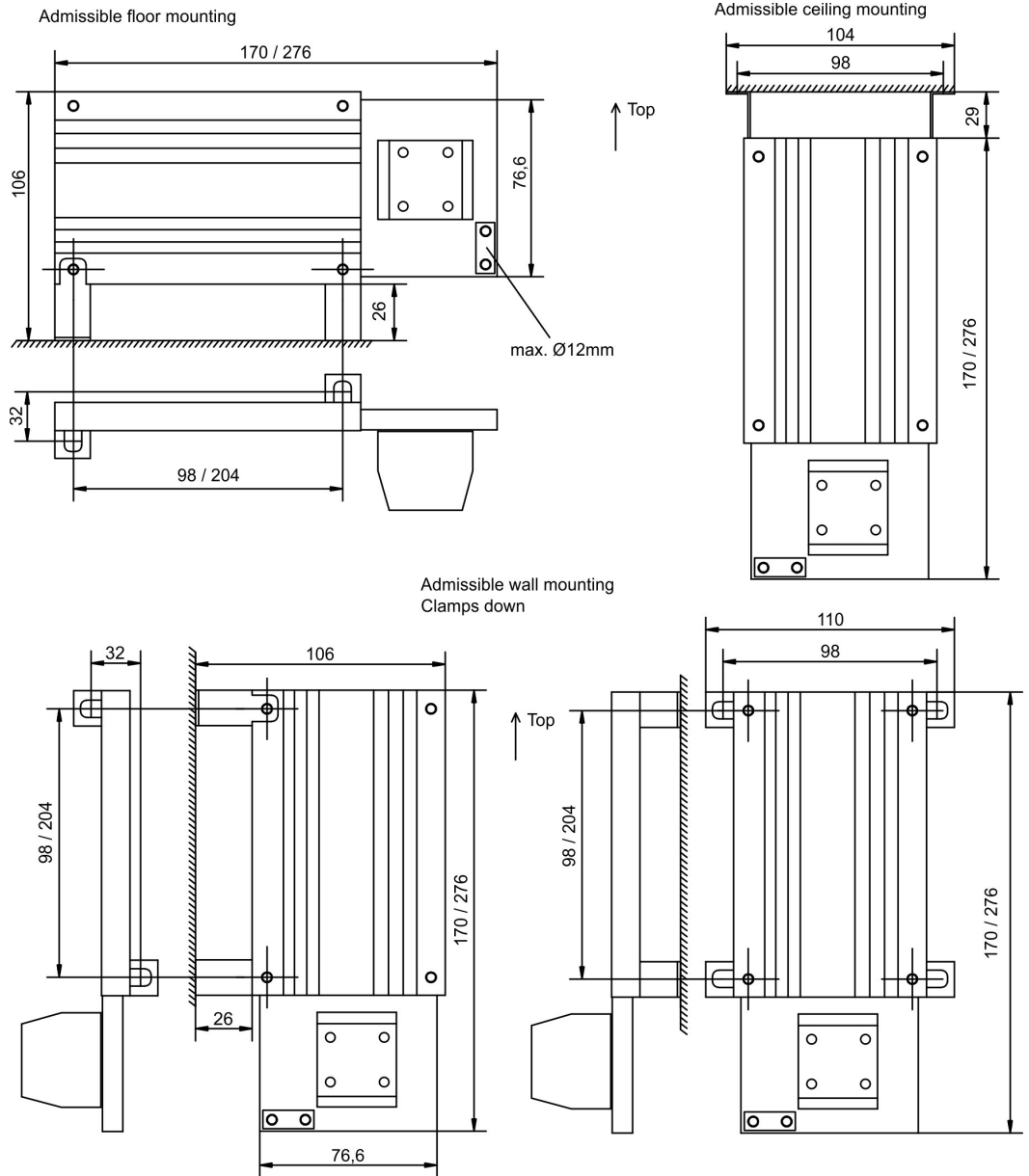

Typ	R	Length	Power	Weight
	Ω	mm	W	Kg
BAFP(U) 100-33	33	170	100	0,3
BAFP(U) 200-33	33	276	200	0,55

Other types of mounting are not admitted !

6.5 External brake resistor BAR(U)



Protection class: IP20



The surface temperature can exceed 250°C. Risk of burns and fire! Measure the temperature before touching.

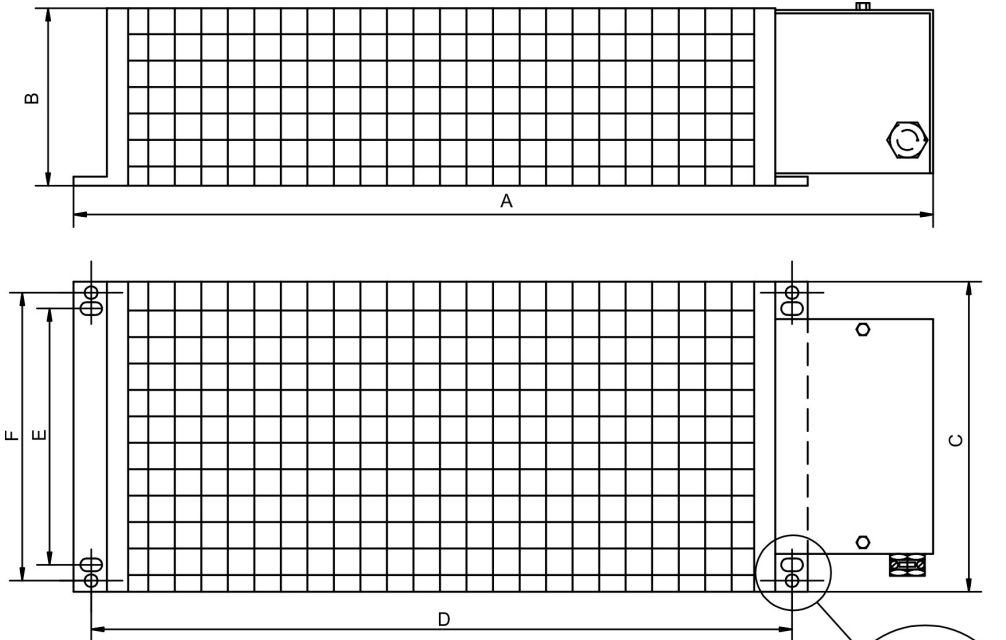

Type	R	Power	A	B	C	D	E	F	weight
	Ω	W	mm	mm	mm	mm	mm	mm	
BAR(U) 500	15	500	549	120	92	430	64	80	3
BAR(U) 1000	15	1000	749	120	92	630	64	80	4
BAR(U) 600	23	600	549	120	92	430	64	80	3
BAR(U) 1000	23	1000	749	120	92	630	64	80	4
BAR(U) 250	33	250	349	120	92	230	64	80	2
BAR(U) 500	33	500	549	120	92	430	64	80	3
BAR(U) 1500	33	1500	649	120	185	530	-	150	5,8
BAR(U) 300	66	300	349	120	92	226	64	80	1,5
BAR(U) 600	66	600	549	120	92	426	64	80	2,3
BAR(U) 1000	66	1000	749	120	92	626	64	80	3,4
BAR(U) 300	91	300	349	120	92	226	64	80	1,5
BAR(U) 600	91	600	549	120	92	426	64	80	2,3
BAR(U) 1000	91	1000	749	120	92	626	64	80	3,4

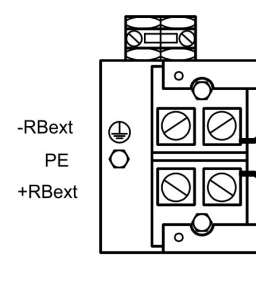
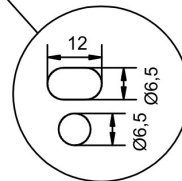

±10%, temperature drift approx. 1%
Cold approx. +8%, 320°C approx. -7%

Admissible floor mounting

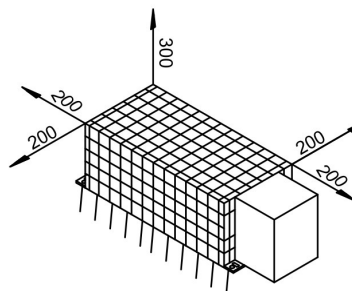

Admissible wall mounting
Clamps down

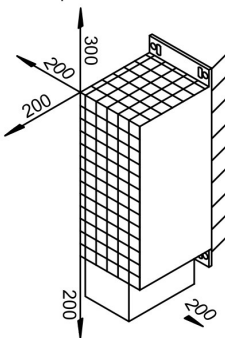

Other types of mounting are not admitted !

6.6 External brake resistor BAS(U)



Protection class: IP20



WARNING

The surface temperature can exceed 250°C. Risk of burns and fire! Measure the temperature before touching.

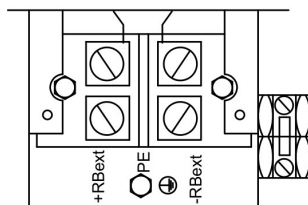
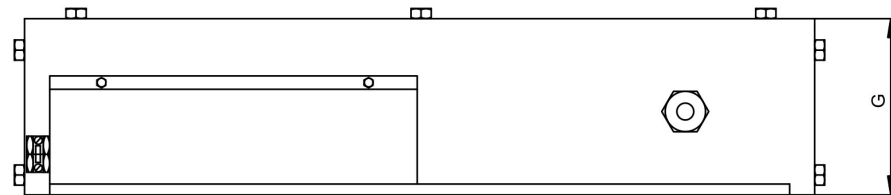
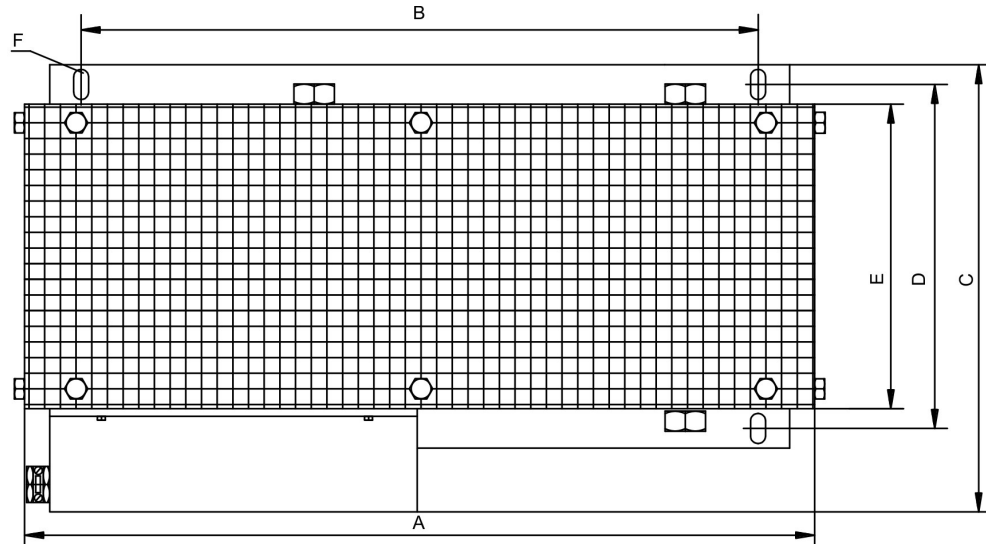

±10%, temperature drift approx. 1%
Cold approx. +8%, 320°C approx. -7%

Admissible floor mounting

Admissible wall mounting
Clamps down

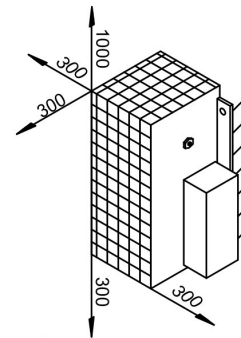
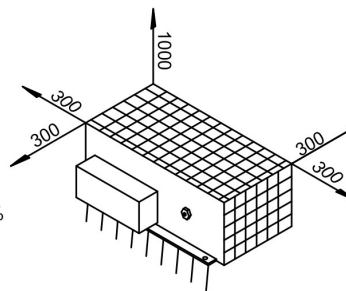

Other types of mounting are not admitted !

	R	Rated power	A	B	C	D	E	F	G	weight
	Ω	W	mm	mm	mm	mm	mm	mm	mm	Kg
BAS(U)2000-10	10	2000	490	380	255	170	150	∅10,5	260	7
BAS(U)3000-10	10	3000	490	380	355	270	250	∅10,5	260	8
BAS(U)6000-10	10	6000	490	380	455	370	350	∅10,5	260	11
BAS(U)2000-15	15	2000	490	380	255	170	150	∅10,5	260	7
BAS(U)3000-15	15	3000	490	380	355	270	250	∅10,5	260	8
BAS(U)6000-15	15	6000	490	380	455	370	350	∅10,5	260	11
BAS(U)2000-23	23	2000	490	380	255	170	150	∅10,5	260	7
BAS(U)3000-23	23	3000	490	380	355	270	250	∅10,5	260	8
BAS(U)4000-23	23	4000	490	380	355	270	250	∅10,5	260	9
BAS(U)3000-33	33	3000	490	380	355	270	250	∅10,5	260	8

7 Capacitor Modules

7.1 General

KCM modules (**K**OLL**M**OR**G**EN **C**apacitor **M**odules) absorb energy generated by the motor when it is operating in generator mode. Normally, this energy is dissipated as waste via brake resistors. KCM modules, however, feed the energy they have stored back into the DC Bus link as and when it is required.

KCM-S	Saves energy: The energy stored in the capacitor module during generative braking is available the next time acceleration happens. The module's inception voltage is calculated automatically during the first load cycles.
KCM-P	Power in spite of power failure: If the power supply fails, the module provides the servo amplifier with the stored energy that is required to bring the drive to a standstill in a controlled manner (this only applies to the power supply voltage; battery-back the 24 V supply separately).
KCM-E	Expansion module for both applications. Expansion modules are available in two capacitance classes.

More information can be found on KDN page "[KCM Capacitor Module](#)".

7.2 Important notes



⚠ DANGER High Voltage up to 900 V!

There is a danger of serious personal injury or death by electrical shock or electrical arcing. It can take over an hour for the modules to self-discharge.

- Switch off (disconnect) the line voltage. You must only work on the connections when the system is disconnected.
- Check the state of charge with a measuring device that is suitable for a DC voltage of up to 1,000 V.
- When measuring a voltage of over 50 V between the DC+/DC- terminals or to ground, discharge the modules as described in the KCM Instructions Manual.

NOTICE

You must read the instructions manual for the servo amplifier/servomotor you are using in your application and observe the safety instructions they contain before commencing mounting/installation work.

Wiring diagram and more important notes concerning wiring can be found in the KCM instructions manual and in the instructions manual of the used servo amplifier.

7.3 Type assignment and order codes

NOTE The KCM modules may only be connected to servo amplifiers with 400/480 V rated voltage.

Servo amplifier	KCM Module	Servo amplifier	KCM Module
S300	all Modules	S701 to S724	all Modules
S400	all Modules	S748	on request
S601 to S620	all Modules	S772	not allowed

Order codes

Type/Order Code	Remarks
KCM-S200-0000	Energy Saving Module, 1.6 kW
KCM-P200-0000	Power Module, 2 kW
KCM-E200-0000	Expansion Module 2 kW
KCM-E400-0000	Expansion Module 4 kW

7.4 Installation example

NOTICE Maximum cable length between servo amplifier and KCM: 500 mm. The DC+ and DC- lines should always be twisted, maximum cross section is 6 mm².

RS422 interface X4 allows data exchange controlled by a terminal software of your choice. Interface setting: 115200 Baud, 8 Data Bits, 1 Stop Bit, No Parity&Flow Control. The X4 mating connector is in the package. The ready signal reports the ready to operate (high level).

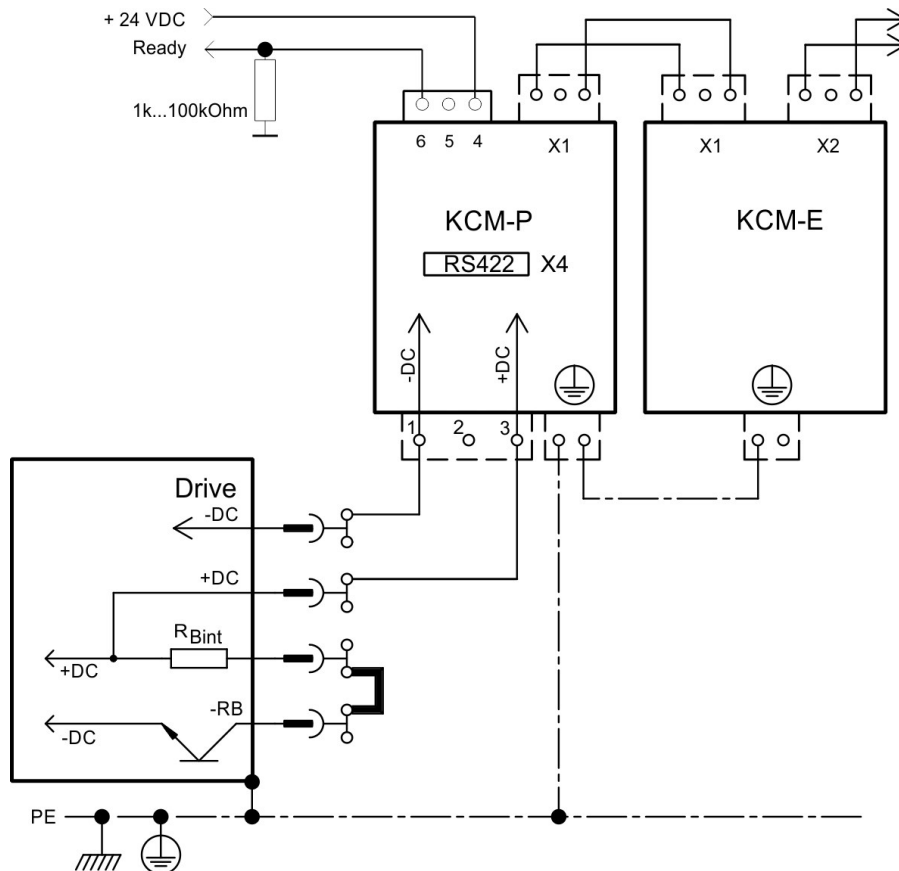

More information is given in the KCM Instructions Manual.

7.5 KCM Module



Observe the safety instructions (→ # 24) and in the instruction manual of the servo amplifier.

Permissible assembly type: Vertical, ground connections at the bottom.
Other assembly positions are not permitted. Observe the required free space to next device. Ensure there is unobstructed convection for cooling purposes.

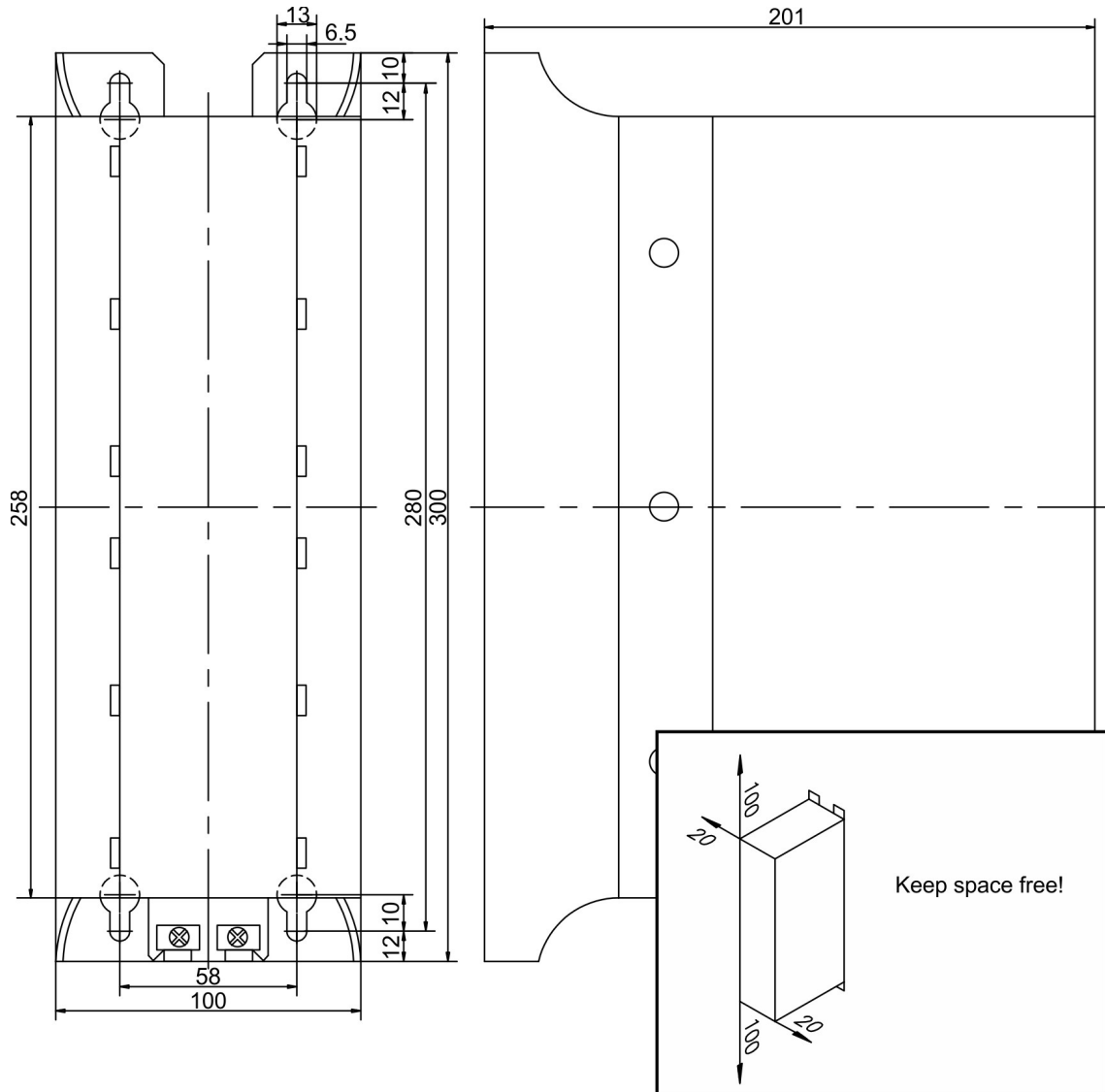

Technical Data

Type	Storage Capacity [Ws]	Rated supply voltage [V=]	Peak supply voltage [V=]	Power [kW]	Protection Class	Inception voltage [V=]	Weight [kg]
KCM-S200	1600	max 850 VDC	max 950VDC (30s in 6min)	18	IP20	calculated	6.9
KCM-P200	2000					470 VDC	6.9
KCM-E200	2000					-	4.1
KCM-E400	4000					-	6.2

8 Motor chokes

8.1 General

Shielded motor cables

For reasons of electromagnetic compatibility, the motor must be supplied with power via a shielded cable. The structure of a cable with 100% shielding and the capacity equivalent circuit diagram (to earth) are shown below.

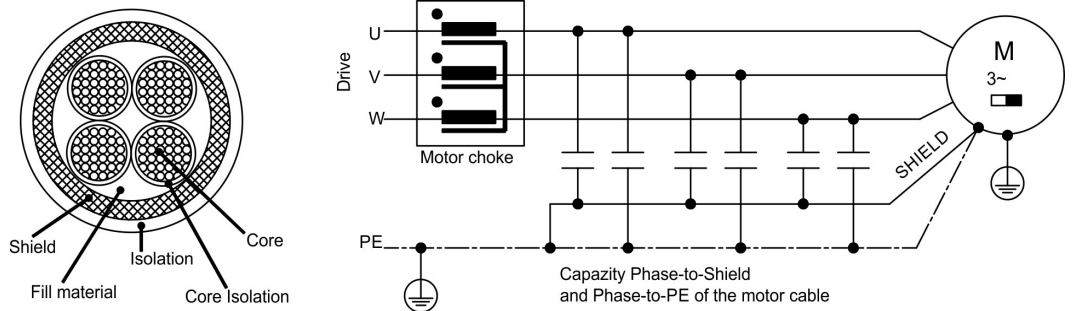

Why use motor chokes?

- To compensate high capacitive charge/discharge currents typical of shielded motor cables approximately 25 m and longer.
- To reduce current alternation noise in the motor.
- To reduce current ripple in the motor.

The digital servo amplifiers' high switching frequencies and steep switching edges give rise to the transfer of capacitive currents to the shield by the three phases (U, V, W). These currents flow from the shield to earth. Depending on the cable length and cable capacity (determined by design), this can lead to the generation of shield currents with peak values of up to 20 A.

These shield currents place a load on the servo amplifiers and motor and, on large systems, lead to shifts in potential which can damage other components.

This effect is evident in particular on systems with multiple amplifiers operating in parallel on the same mains filter.

The motor chokes slow down the rate of rise of the motor current (reduce edge steepness), thereby reducing the current transferred to the shield.

Why is the cross-section of the motor cable important?

Motor cables longer than 50 m with a small cross-section (e.g. 4 x 1.0 mm²) and therefore a higher equivalent resistance are able to reduce the oscillation tendency of the LCR oscillating circuit (amplifier/choke/cable/motor). This cross-section can also be advantageous for cable lengths shorter than 50 m if the cable capacity and motor inductance are very high. However, the current loading of the cable must always be within the limits specified by EN 60204.

8.2 Important notes



DANGER High Temperature!

Risk of light burns and fire. The surface temperature can exceed 80°C.

- Therefore, you should make sure that the choke is mounted a sufficient distance away from neighbored components.
- Provide the requisite conditions for unobstructed convection to cool the choke.

NOTICE

You must read the instructions manual for the servo amplifier/servo motor you are using in your application and observe the safety instructions they contain before commencing mounting/installation work. This manual is only valid in conjunction with the instructions manual for the servo amplifier and servo motor you are using in your application.

Mount the motor choke 3YLN on a conductive earthed assembly plate in the switchgear cabinet. The choke box 3YL-24 can be mounted to DIN rails as well.

The motor choke is wired into the cable close to the amplifier. When laying the motor cable, allow about 400 mm for the connection to the choke.

Connection diagram see the servo amplifier instructions manual.

8.3 Type assignment and order codes

Servo amplifier	Motor choke	Condition
S300	3YL-24, 3YLN-xx	Motor cable \geq 25m
S400	3YL-24, 3YLN-xx	Motor cable \geq 25m
S601...620	3YL-24, 3YLN-xx	Motor cable \geq 25m
S701...724	3YL-24, 3YLN-xx	Motor cable \geq 25m
S748/772	usually not required, in case of cable length \geq 25m and unusual conditions, ask our customer support	

Order codes

Article	Nominal Current	Approvals	Order code
Motor choke box 3YL-24	24 A	CE	DE-90074
Motor choke 3YLN-06	6 A	CE, UL	DE-107929
Motor choke 3YLN-10	10 A	CE, UL	DE-107930
Motor choke 3YLN-14	14 A	CE, UL	DE-107931
Motor choke 3YLN-20	20 A	CE, UL	DE-107932
Motor choke 3YLN-24	24 A	CE, UL	DE-201447

8.4 Motor choke 3YL-24

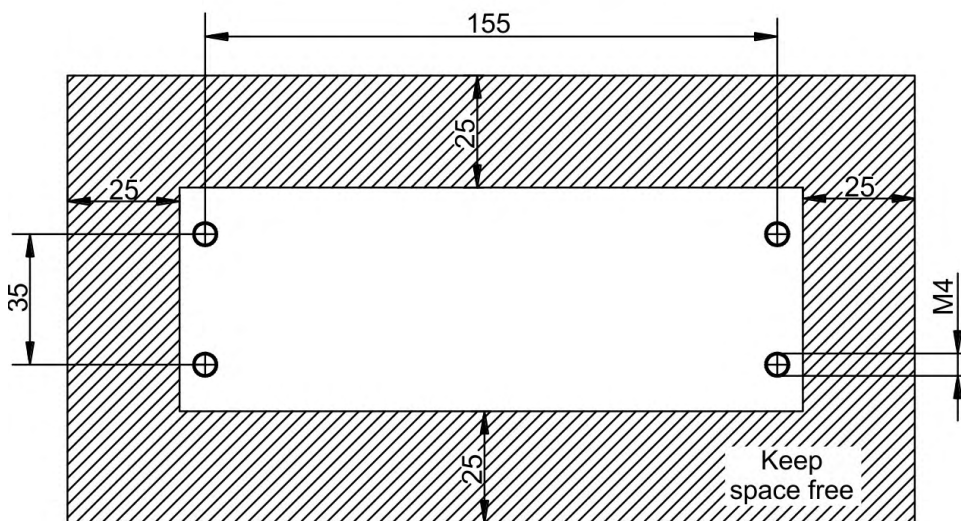
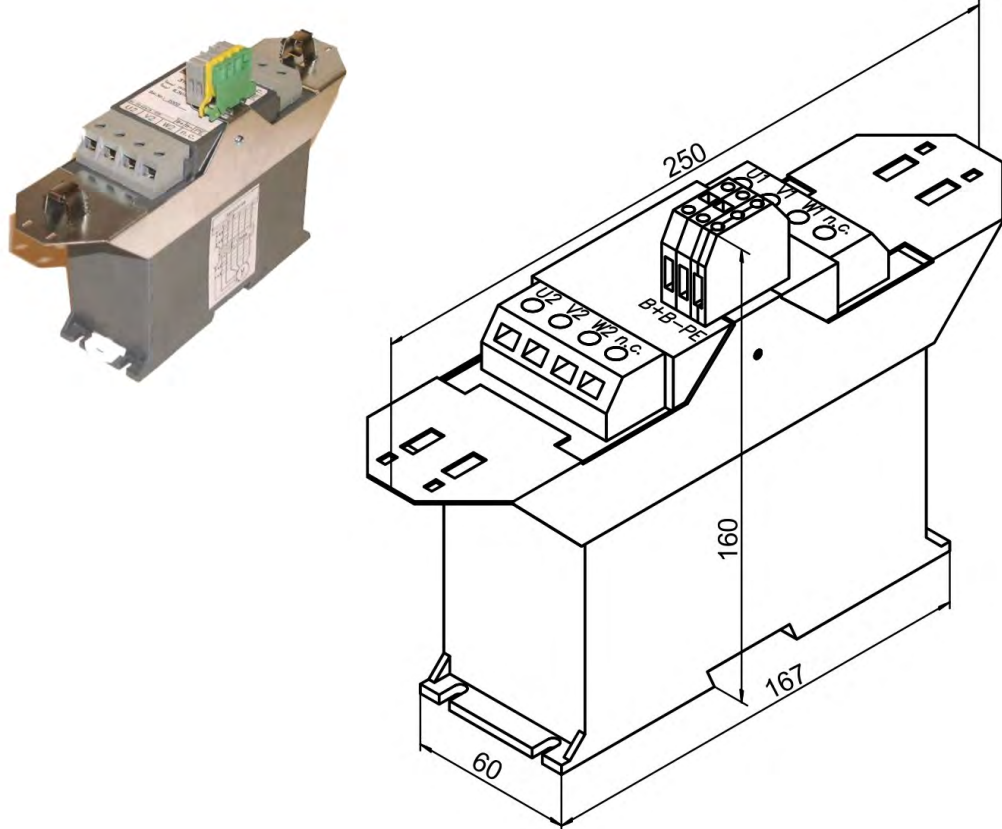

Technical data:

Rated data	Sym	Unit	3 YL-24
Rated Current	I _{0rms}	A	Max.3x 24
Frequency	f _{max}	kHz	8.3
Inductivity	L	μH	120
Resistance	R	mOhm	2.6
Weight	G	kg	1.4
Cable diameter (Shield clamp)	-	mm	4 to 13.5
Wire cross section U-V-W max. (terminals)	-	mm ²	4
Wire cross section BR+/- max. (terminals)	-	mm ²	2.5

8.5 Motor choke 3YLN-xx

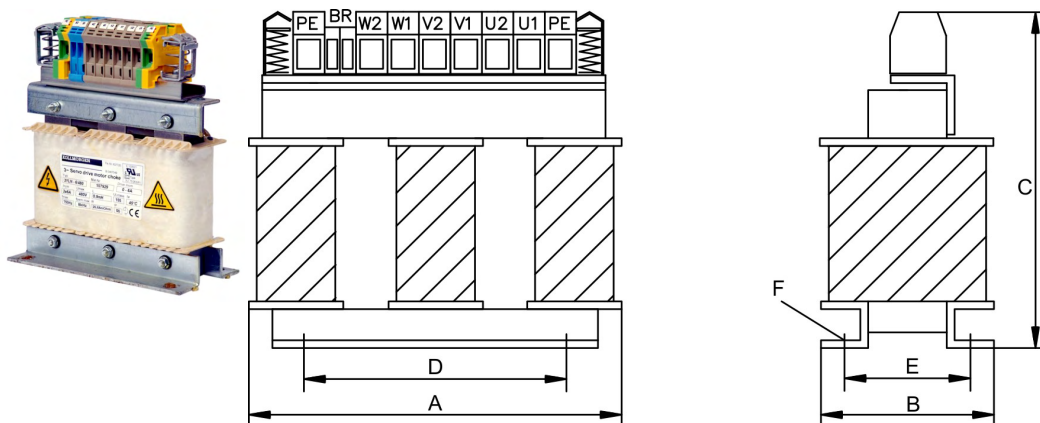

Technical Data:

Rated Data	Sym	DIM	3YLN-06	3YLN-10	3YLN-14	3YLN-20	3YLN-24
Rated current	I _{0rms}	A	6	10	14	20	24
Rated voltage	U _{nom}	V	480				
Rated frequency	f _{nom}	Hz	0 to 150				
Max. frequency	f _{max}	kHz	8				
Inductivity	L	μH	900	900	900	450	450
Power loss	P	W	12	14.5	19.4	22.3	23.2
Protection class	-	-	IP00				
Temperature class	-	-	F				
Operation class	-	-	S1				
Weight	G	kg	4.5	5.5	10	10	10
Cable diameter (Shield clamp)	-	mm	4 to 13.5				
Wiring cross section max. (Terminals)	-	mm ²	10	10	16	16	16
Width	A	mm	155	155	190	190	190
Depth	B	mm	90	105	125	125	125
Height	C	mm	195	195	230	230	230
Mounting hole distance	D	mm	130	130	170	170	170
Mounting hole distance	E	mm	56.5	71.5	78	78	78
Mounting screws	F	-	4xM6	4xM6	4xM6	4xM6	4xM6

9 Cables

NOTE

Kollmorgen assumes no liability for errors or damage to equipment caused by cables manufactured by customers.

9.1 Technical data for cables

Information on the chemical, mechanical and electrical characteristics of the cables can be found in our KDN on page [Cables](#).

Insulation material

- Sheathing: PUR (polyurethane, code 11Y)
- Core insulation: PETP (polyesteraphthalate, code 12Y)

Capacitance (phase to shield)

- Motor cable: less than 180 pF/m (cross sections >6mm² have larger capacitance)
- Feedback cable: less than 120 pF/m
- Hybrid Cable: special requirements

Technical data

- The brackets in the core definition indicate the shielding
- All cables are suitable for use as trailing cables
- The technical data refer to use as moveable cables
- Operating life : 10 million bending cycles
- All cables are UL recognized

9.2 Tools

Only work with the special tools that are required for the used connectors. You can obtain these special tools from the manufacturer of the connectors or contacts.

9.3 PC connection

Kollmorgen digital "Sx" type servo amplifiers are equipped with a serial RS232 interface to facilitate communication with a standard personal computer (PC). Various types of interface can be used on the PC. Appropriate cables and in some cases specific accessories will be required to establish the connection between servo amplifier and PC.

Article	Order Code
Cable PC-S300/S400/S600/S700 3m, 9poles	DE-90067
Setup Kit S300/S400/S600/S700 USB	DE-107666
Y-Adapter for splitting CAN/RS232 and Multilink	(→ # 33)

Setup Kit S300, S400, S600, S700 USB



An interface converter is required to use the USB interface on a PC. Our "USB" setup kits contain a USB serial converter and a serial PC cable suitable for the amplifier type.

PC cable for S300, S400, S600, S700



For the purpose of parameterisation and for firmware upgrades, the servo amplifiers can be connected to the serial RS232 interface on a PC. The connecting cable must be shielded. The braided shield on the RS232 connecting cable is conductively connected to the front panel of the servo amplifier via the connector housing on the Sub-D male connector.

Y Adapter (Splitter) for S300/S600/S700

The signals for the serial link to the PC and the CAN interface are routed via the same connector on the servo amplifier (X6). Our Y adapters can be used for simultaneous access to both interfaces. In this case, the interface signals are routed via separate connectors.

Article	Order Code
Y-Programming-Adapter 1 Axis	DE-108211
Y-Adapter -SR6Y- 4 Axes (Multilink Cable)	DE-90060
Y-Adapter -SR6Y6- 6 Axes (Multilink Cable)	DE-92042

The multi-axis Y adapters support the simultaneous setup (multi-link) of a number of S300/S600/S700 in a single setup session.

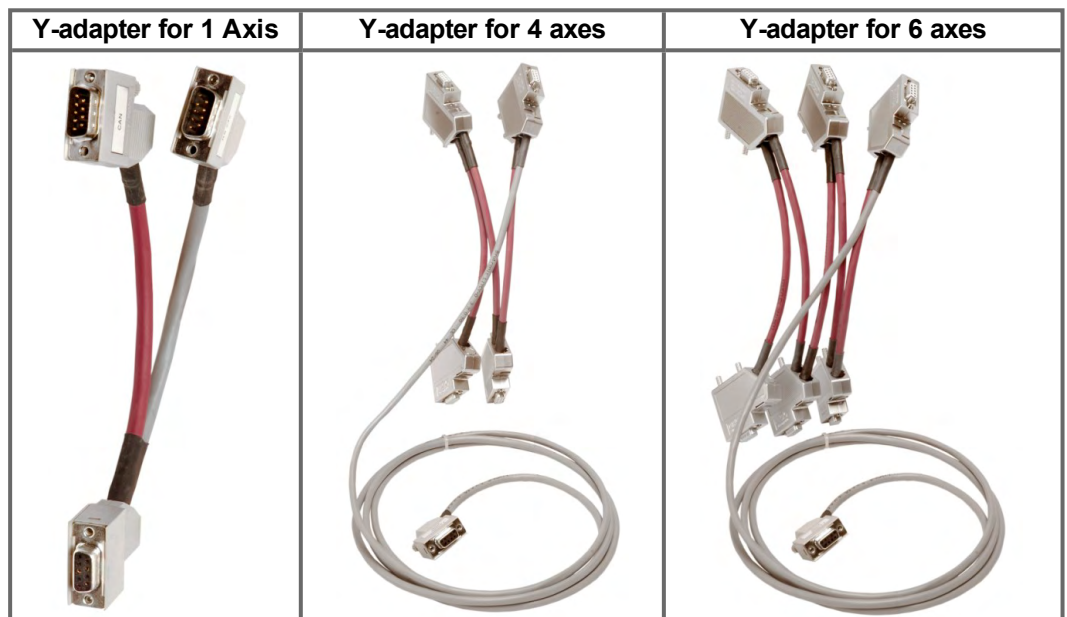

9.4 Power Voltage Supply, external brake resistor, DC bus link

The connectors used (40 A and higher fixed terminals) are included in the scope of supply of the servo amplifier. If necessary, the connectors are coded and printed with the corresponding terminal designation. The table indicates the type of cable required for each intended purpose.

NOTE
NOTICE

We do not deliver configured cables for this interface.

You must always observe the specifications in respect of cable cross-sections contained in the instructions manual for the servo amplifier you are using in your application. Fit suitable wire end ferrules or plug connectors to stripped conductors. A connection diagram appears in the servo amplifier instructions manual.

9.4.1 Recommended cable type

The table indicates the cross section and cable shielding required for each intended purpose.

Purpose	max. length	recommended cross section (In = drive rated output current)		
		In=1.5...10A	In=12...24A	In=40...72A
AC-supply	-	1.5	4	25
DC-bus link	0.5 m	1.5	4	25
	2m	(2 x 1.5)	(2 x 4)	(2 x 25)
Ext. regen resistor	5m	(2 x 1.5 + PE)		(2 x 25 + PE)

Valid for single axis systems. For multi axes and cable types please consult our customer support.

9.4.2 Mating connector (part of delivery)

Amplifier	Mains supply 1		Mains supply 2		DC-link bus		Brake resistor	
	#	Order Code	#	Order Code	#	Order Code	#	Order Code
S300-230V	X0	DE-105856	-	-	X8	DE-107556	X8	DE-107556
S300-400V	X0	DE-107557	-	-	X8	DE-107558	X8	DE-107558
S400	X0	DE-102583	-	-	X0	DE-102583	X0	DE-102583
S601...620	X0A	DE-92258	X0B	DE-92259	X7	DE-90064	X8	DE-90065
S701...724	X0	DE-200451	-	-	X8	DE-200452	X8	DE-200452

9.4.3 Mating connector (optional)

Amplifier	Mains supply		DC-link bus / Brake resistor	
	#	Order Code	#	Order Code
S701...724	X0Y	DE-200851	X8Y&X4Amini	DE-201942
S701...724	X0F	DE-200955	X8F	DE-200956

With Y-connectors you can daisy-chain supply voltage or DC-bus link to several amplifiers. For details see instructions manual of the servo amplifier. The F-connectors are for fast wiring (no screws).

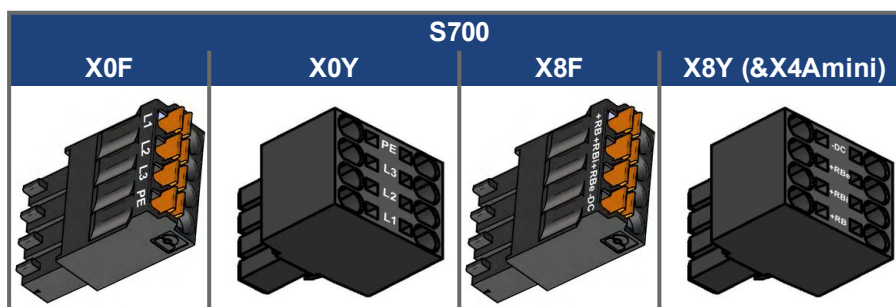

9.4.4 Preparing cables for S300/S400/S601...620/S701...724

The connections are located on the bottom or front of the servo amplifier. Terminal connectors are used, which are included in the delivery package for the servo amplifier. The connectors are coded and have the appropriate connection designation printed on them. **They must never be mixed up.**

Follow the pin assignment in the instructions manual. When connecting an external brake resistor, please note that the link cable must first be removed.

Preparing unshielded cables

If shielding is not necessary, then we recommend using single cores for the wiring inside the switchgear cabinet.

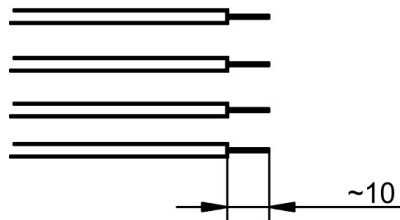
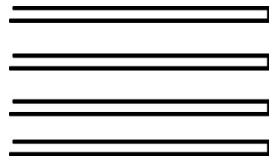

Strip off about 10 mm of the insulation at the ends of the cores. Take care to avoid damage to the copper strands while doing this. Depending on the cross-section of the core and the type of bootlace ferrule that is used, the length that has to be stripped may vary by several millimeters.

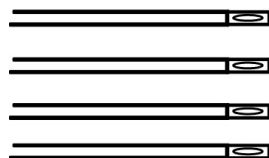

Apply bootlace ferrules to the conductors. As an alternative, you can also use terminal pins.

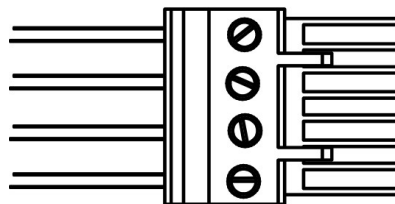

Push the ends of the conductors into the connector as far as they will go. Follow the pin assignment in the servo amplifier's instructions manual. Tighten the screws of the terminals. Take care that the insulation is not trapped in the terminals.

Preparing shielded cables

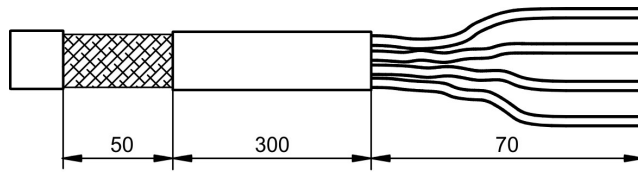

First, remove the outer covering of the cable and the shielding braid over a length of about 70 mm. Then remove just the outer covering for about another 50 mm, without damaging the shielding braid.

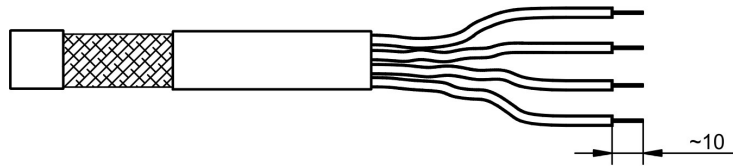

Strip off about 10 mm of the insulation from the ends of the cores. Take care to avoid damage to the copper strands while doing this. Depending on the cross-section of the core and the type of bootlace ferrule that is used, the length that has to be stripped may vary by several millimeters.

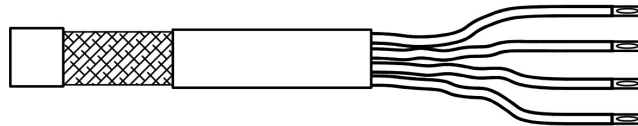

Apply bootlace ferrules to the conductors. As an alternative, you can also use terminal pins instead of bootlace ferrules.

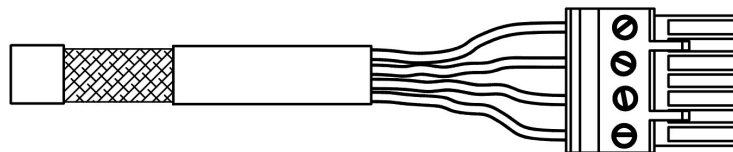

Push the ends of the conductors into the connector as far as they will go. Follow the pin assignment in the instructions manual. Tighten the screws of the terminals. Take care that the insulation is not trapped in the terminals.

9.4.5 Preparing cables for S748/772

The connections for the power supply, the ballast resistor and the DC-link are made through terminals on the bottom of the servo amplifier. These terminals can accept core cross-sections from 10 to 50 mm².

The AC supply connection is used as an example for preparing a cable.

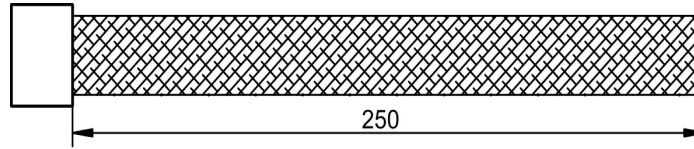

Remove the outer covering of the cable over a length of about 250 mm, without damaging the shielding braid.

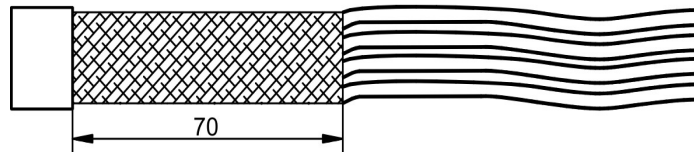

Shorten the shielding to a length of about 70 mm.

Shorten the three cores for the supply phases to 200 mm. Strip off all cores for a length of about 25 mm. This length depends on the core cross-section and the bootlace ferrules that are used.

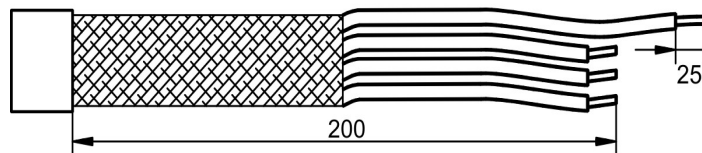

Apply bootlace ferrules to the conductors.

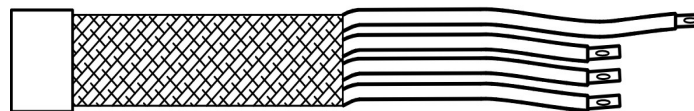

Connect up the cable according to the wiring diagram in the instructions manual for the servo amplifier and take care that no insulation is trapped in the terminals.

9.5 24V auxiliary voltage supply

Connectors are used, that are included in the delivery package of the servo amplifiers. If necessary, the connectors are coded and printed with the corresponding terminal designation.

NOTE

We do not deliver configured cables for this interface.

NOTICE

You must always observe the specifications in respect of cable cross-sections contained in the instructions manual for the servo amplifier you are using in your application. Fit suitable wire end ferrules or plug connectors to stripped conductors. A connection diagram appears in the servo amplifier instructions manual.

9.5.1 Mating connector (part of delivery)

Amplifier	Connector	Order Code
S300	X4	DE-107555
S400	X0	DE-102583
S601...620	X4	DE-90062
S701...724	X4A	DE-200449
S701...724	X4B	DE-200450
S748/772	X4	DE-201241
S748/772	X9B	DE-201193

9.5.2 Recommended cable type

Purpose	recommended cable
24V Aux. Voltage Observe voltage drop!	H07V-K 1.5 or H07V-K 2.5

9.5.3 Preparing cables

The connection is on the front panel of the servo amplifier. A Combicon connector is used, which is included in the delivery package of the servo amplifiers.

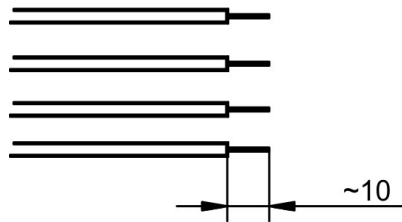
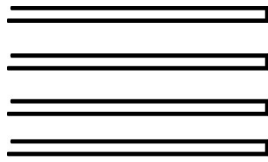

Strip off about 10 mm of the insulation at the ends of the cores. Take care to avoid damage to the copper strands while doing this. Depending on the cross-section of the core and the type of bootlace ferrule that is used, the length that has to be stripped may vary by several millimeters.

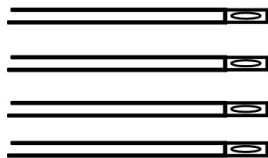

Apply bootlace ferrules to the conductors. As an alternative, you can also use terminal pins.

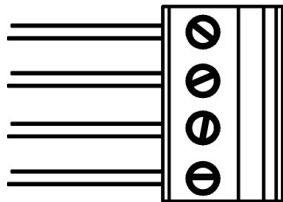

Push the ends of the conductors into the connector as far as they will go. Follow the pin assignment in the instructions manual. Tighten the screws of the terminals. Take care that the insulation is not trapped in the terminals.

9.6 Digital/analog Inputs/Outputs

The cables for analog signals must be twisted pairs, and shielded. The digital signals can be connected by single wires.

NOTE

We do not deliver configured cables for this interface.

Mating connector (part of delivery)

Amplifier	Digital / analog signals				STO Signals	
	#	Order Code	#	Order Code	#	Order Code
S300	X3	DE-107554	-	-	X4	DE-107555
S400	X3	DE-102585	X1	DE-102584	-	-
S601...620	X3	DE-90061	-	-	X10	DE-101696
S701...724	X3A	DE-200447	X3B	DE-200448	X4B	DE-200450
S748/772	X3A	DE-200447	X3B	DE-200448	X4	DE-201241

Recommended cable type

Purpose	max. length	recommended cable
Digital I/O	10m	H07VK 0,5
BTB	10m	
Digital GND	10m	
Analog Setpoint	25m	LiYCY (TP) 4x2x0.25
Analog GND	25m	

Color code for shielded cable

Signal	Color*	Cable
AGND	GY	LiYCY (TP) 4x2x0.25
analog in 1+	WH	
analog in 1-	BN	
analog in 2+	GN	
analog in 2-	YE	
analog out 1	PK	
analog out 2	BU	
AGND	RD	

* according to IEC 60757

Preparing cables

For simplicity, the instructions for preparation only show the section with the cores that have to be shielded and twisted pairs.

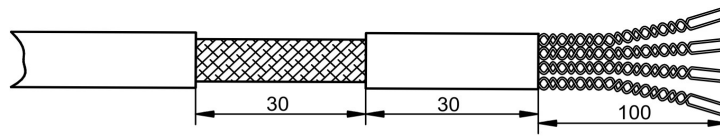

Remove the outer covering and the shielding braid over a length of about 100 mm.

Remove another section of the outer covering, about 30 mm long, without damaging the shielding braid.

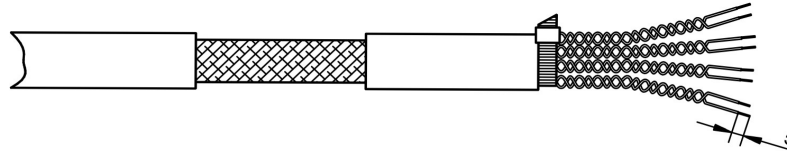

Secure the cores where they emerge, with a cable tie. Strip off the insulation from the cores for a length of about 5 mm, without damaging the copper strands. This length can vary, according to the type of bootlace ferrule that is used.

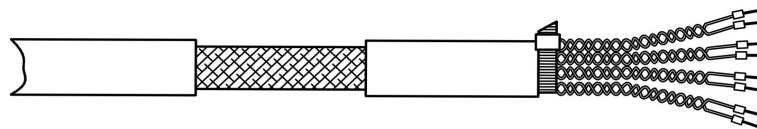

Fit appropriate bootlace ferrules or terminal pins to the bared ends of the cores.

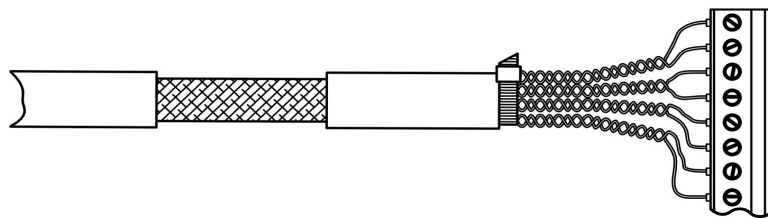

Wire up the screw terminals of the connector according to the wiring diagram (see also the instructions manual for the servo amplifier). Tighten the screws and take care that the insulation is not trapped in the terminals.

9.7 Encoder Emulation, Stepper motor control, Master-Slave

This interface can be used for several applications (see the amplifiers instructions manual). The material requirements are always the same.

NOTE

We do not deliver configured cables for this interface.

9.7.1 Mating connector, cable type

Article	Description	Order Code
Cable	4x2x0.25 (per meter)	DE-92186
Sub-D connector kit	Socket 9-pole, housing and screws	DE-81784

9.7.2 Connection

The cable used must be shielded, with twisted pairs to (suggestion according to DIN 47100). Since it is important which signal pairs are twisted together, the following table shows the colors of the individual cores (to IEC 60757). The connector assignment is determined by the use of the interface; see the servo amplifier instructions manual.

SubD9 S300...S700	Core color @ 5x2x0.25	
	ROD	SSI, Stepper motor control, Master-Slave
1	WH	WH
2	GN	n.c.
3	YE	n.c.
4	GY	GN
5	PK	YE
6	BU	GY
7	RD	PK
8 n.c.	BK	BK
9 n.c.	BN	n.c.

9.7.3 Termination resistors

Depending on servo amplifier type (see instructions manual for the servo amplifier) and application, the cable must be terminated by termination resistors at the amplifier end or the control end. The resistance values depend on the characteristic impedance of the cable material.

Pin	Interface function (S300/S400/S600/S700)							
	ROD		SSI		Stepper control		Master-Slave	
	Amplifier	Controller	Amplifier	Controller	Amplifier	Controller	Master	Slave
1	-	-	-	-	-	-	-	-
2	-	R ~ 150Ω	-	-	-	-	-	-
3	-		-	-	-	-	-	-
4	-	R ~ 150Ω	R ~ 150Ω	-	R ~ 150Ω	-	-	R ~ 150Ω
5	-		-	-		-	-	-
6	-	R ~ 150Ω	-	R ~ 150Ω	R ~ 150Ω	-	-	R ~ 150Ω
7	-		-			-	-	
8	-	-	-	-	-	-	-	-
9	-	-	-	-	-	-	-	-

9.7.4 Preparing cables

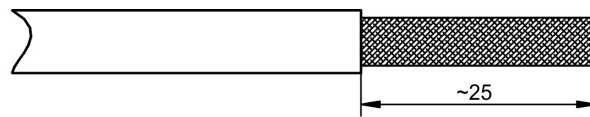

Remove the outer covering of the cable over a length of about 25 mm, without damaging the shielding braid.

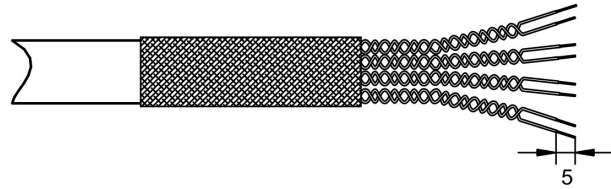

Push the shielding braid back over the outer covering of the cable, and strip off the ends of the cores over a length of about 5 mm, without damaging the copper strands.

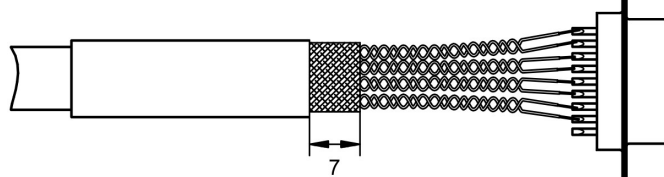

Push a suitable piece of heatshrink tubing over the outer cover, and heat it up. Leave about 7 mm free at the end.

Solder the ends of the cores (with the resistors where required) into the solder buckets of the SubD connector. Insulate the connections and the resistors so that there can be no accidental contact between them or with the connector housing.

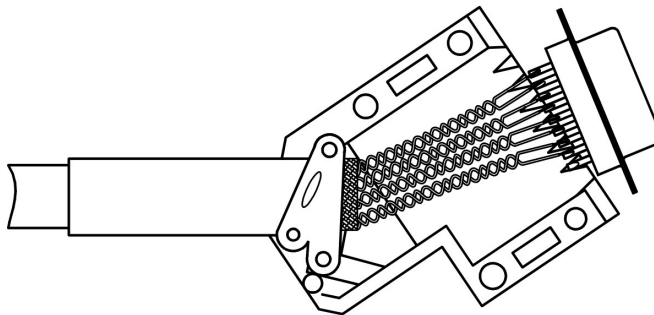

Use the strain relief to fix the cable to the bottom half of the housing. Do not overtighten the screws, or the cable will be crushed. Place the SubD connector, with the wider side below, in the bottom half of the housing.

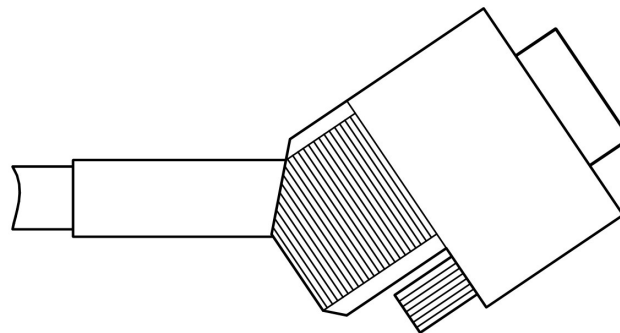

Check the connections before closing the housing, since it cannot be opened again afterwards without damage. Place the fixing screw in position in the housing, and then press the two halves of the housing firmly together. Take care that the fixing screw and the SubD connector insert are properly located.

9.8 CAN bus cable

According to ISO 11898 you should use a bus cable with a characteristic impedance of 120 Ω. The usable cable length depends on the transmission rate. The values that we have measured can be taken as a guide, but they should not be interpreted as limits:

Cable data

- Characteristic impedance: 100-120 Ω
- Cable capacitance: max. 60 nF/km
- Conductor (loop) resistance: 159.8 Ω/km

Cable length, depending on the transmission rate:

Transmission rate / kbps	1000	500	250
max. cable length / m	20	70	115

The table refers to the total cable length between the ends of the bus. Longer transmission distances can be achieved with a lower cable capacitance (max. 30 nF/km) and lower loop resistance (115 Ω/km).

NOTE

We do not deliver configured cables for this interface.

Usage of the materials in the table below ensure that all the requirements are met.

Part	Designation	Order code
Cable	Li2YCY (TP) 2x2x0.25mm ²	DE-86834 (cut to length)
SubD kit	9-pin SubD connector (socket)	DE-90650

If your cable has more connectors than you need, any of them can be left free.

For EMC reasons, the SubD connector housings must fulfil the following conditions:

- metal or metallic-coated housing
- provision for connecting the cable shielding to the housing, large-area connection

Wiring diagram

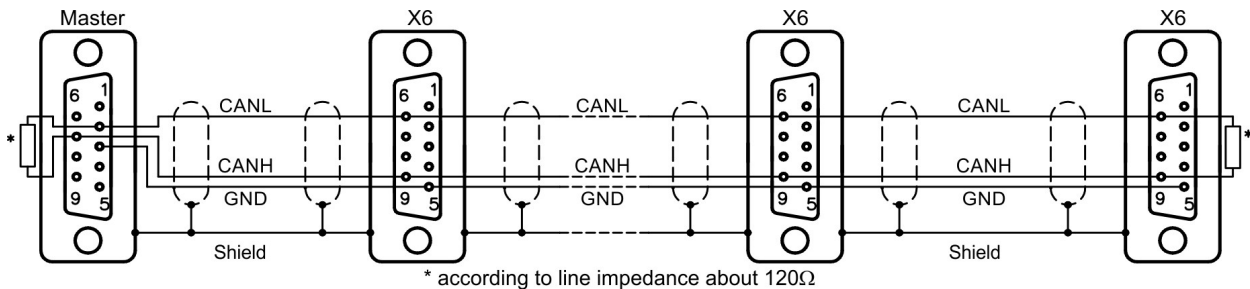

Preparing cables

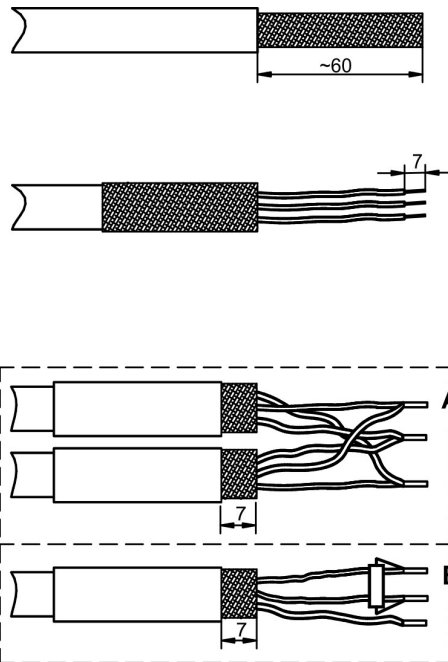

Remove the outer covering of the cable over a length of about 60 mm, without damaging the shielding braid.

Push the shielding braid back over the outer covering of the cable, and strip off the ends of the cores over a length of about 7 mm, without damaging the copper strands. The length can vary according to the type of bootlace ferrule that is used.

Push a suitable piece of heat-shrink tubing over the outer cover, and heat it up. Leave about 7 mm free at the end. Fit appropriate bootlace ferrules to the cores. Depending on which type of connector you are preparing, use diagram A (inner bus connector), or B (outer bus connector). Use ferrules for twin wires if you have to connect two cores, or one core and a termination resistor to a single connection.

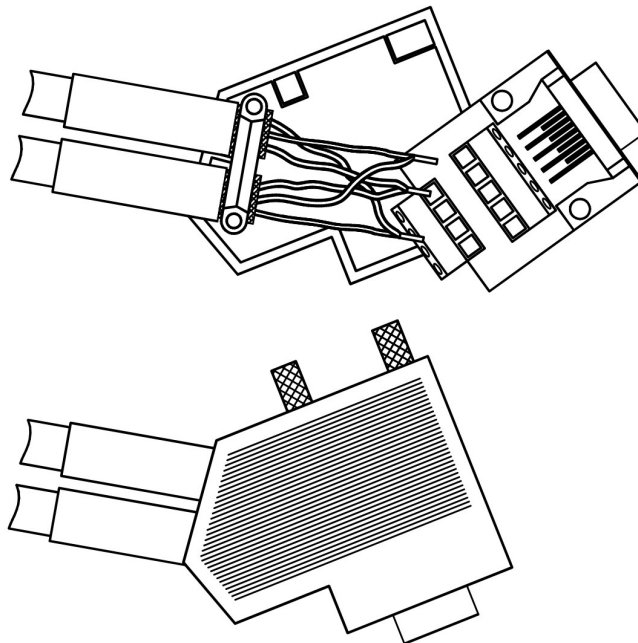

Use the strain relief to fix the cable to the bottom half of the housing. Do not overtighten the screws, or the cable will be crushed. Wire up the terminals according to the wiring diagram, and place the connector PCB with the terminals underneath in the lower half of the housing.

Put the two knurled screws in place, and press the two halves of the housing together until the four lugs snap into position.

Take care that the connector PCB and the knurled screws are properly located.

9.9 Motor Hybrid Cables

S300 and S700 series servo amplifiers have a 15 pole SubD female connector to connect the feedback and a terminal connector for power wiring.

NOTE For SFD3 connection to S300 or S700, the feedback connector on the servo amplifier end contains electronics.

9.9.1 Single (hybrid) motor cables for AKM1 Motor (i-tec connector)

Usable for AKM1 (connector option D, feedback options CA). A shield clamp is delivered with the cable. Define the required length in clear text (steps of 1 m). Maximum cable length 25 m.

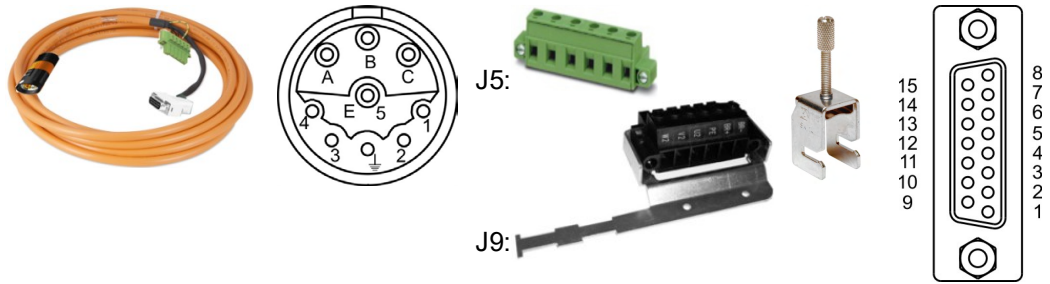

SFD3 & Brake	Usable to connect	Motor end	Order code
(4x1+(2x0.34)+(2x0.75))	S300 (230V) and AKM1*	i-tec	CCJ5A3-010-vvv-00
	S700 and AKM1*	i-tec	CCJ9A3-010-vvv-00

* Motors with connector D and feedback CA

9.9.2 Single (hybrid) motor cables for AKM2-6 (M23/SpeedTec)

9.9.2.1 With shield clamp

Usable for AKM2 to AKM6 (connector option D, feedback option CA, GE and GF). A shield clamp is delivered with the cable. Define the required length in clear text (steps of 1m). Maximum cable length 25 m.

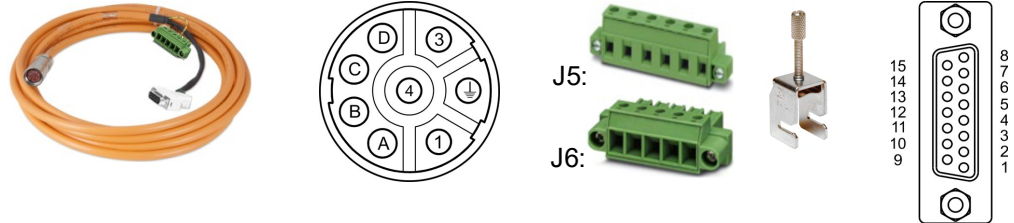

SFD3/DSL & Brake	Usable to connect	Order code
(4x1.50+(2x0.34)+(2x1))	S300 (230V) and AKM2-6*	CCJ5A2-015-vvv-00
(4x2.50+(2x0.34)+(2x1))		CCJ5A2-025-vvv-00
(4x1.50+(2x0.34)+(2x1))	S300 (480V) and AKM2-6*	CCJ6A2-015-vvv-00
(4x2.50+(2x0.34)+(2x1))		CCJ6A2-025-vvv-00
(4x1.50+(2x0.34)+(2x1))	S300 (230V) and AKM2-6* Washdown	WCJ5A1-015-vvv-00
(4x2.50+(2x0.34)+(2x1))		WCJ5A1-025-vvv-00
(4x1.50+(2x0.34)+(2x1))	S300 (480V) and AKM2-6* Washdown	WCJ6A1-015-vvv-00
(4x2.50+(2x0.34)+(2x1))		WCJ6A1-025-vvv-00

* Motors with connector D and feedback CA

9.9.2.2 With shield plate

Usable for AKM2 to AKM6 (connector option D, feedback option CA, GE and GF). Drive connector with mounted shield plate. Define the required length in clear text (steps of 1 m). Maximum cable length 25 m.

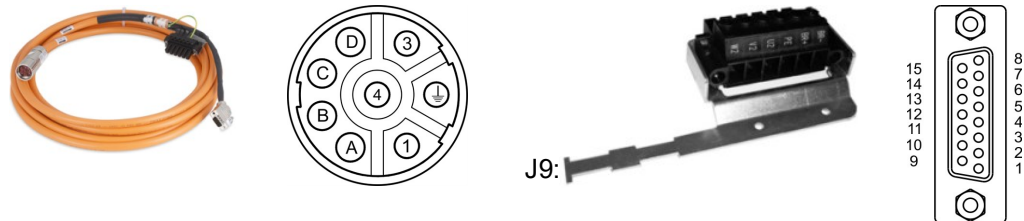

SFD3/DSL & Brake	Usable to connect	Order code
(4x1.50+(2x0.34)+(2x1))	S700 and AKM2-6*	CCJ9A2-015-vvv-00
(4x2.50+(2x0.34)+(2x1))		CCJ9A2-025-vvv-00
(4x4+(2x0.34)+(2x1))		CCJ9A2-040-vvv-00
(4x1.50+(2x0.34)+(2x1))	S700 and AKM2-6* Washdown	WCJ9A1-015-vvv-00
(4x2.50+(2x0.34)+(2x1))		WCJ9A1-025-vvv-00
(4x4+(2x0.34)+(2x1))		WCJ9A1-040-vvv-00

* Motors with connector D and feedback CA

9.10 Motor Power Cables

9.10.1 General

Standard versions of Kollmorgen motors have either one connector or one terminal box for the power connection. Optional connection types are described in the relevant motor manual.

Motor series	Power Connection	Motor series	Power Connection
AKM1...8 =< 22A	Connector size M23	Cartridge DDR =< 22A	Connector size M23
AKM7...8 > 22A	Connector size M40	Cartridge DDR > 22A	Connector size M40
AKM8	Terminal box	DBL1...6 / DBK1...4	Connector size M23
AKMH2...6	Connector size M23	DBL7...8	Terminal box
VLM2...6	Connector size M23		

Depending on their power ratings, Kollmorgen servo amplifiers are equipped with connectors or fixed screw terminals.

Technical data of the used cable material can be found in our KDN on page [Cables](#).

9.10.2 Motor cables, configured



The cables differ in respect of how they are connected to the amplifier. There are major differences in connection method due to the varying requirements in respect of minimum code distances, different shielding concepts depending on rated voltage and current load. Our pre-assembled ready-to-use cables meet the requirements of relevant CE and UL directives.

NOTE

Different conductor cross-sections are required for different motors, and that for motors with a holding brake the brake signals are also attached through this connector.

Connections standard motor connectors

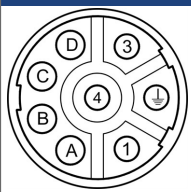
The view is as seen from the contact side of the mating connector.

Option C (M23), wire max 4mm ²					Option H (M40, wire max. 16mm ²				
	Pin	Signal	Pin	Signal		Pin	Signal	Pin	Signal
	1	U2	A	+ Br		U	U2	+	+ Br
	4	V2	B	- Br		V	V2	-	- Br
	3	W2	C	n.c.		W	W2	1	Option J only
	PE (2)	PE	D	n.c.		PE	PE	2	Option J only

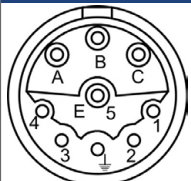
Option Y (y-tec), wire max 1.5mm ²				
	Pin	Signal	Pin	Signal
	1	BR +	A	U
	2	BR -	B	W
	3	n.c.	C	V
	4	n.c.	E	n.c.
	5	n.c.	⊕	PE

Material list for cables with M23/M40 connectors

Part	Designation	Order Code
Cable	Overview ((→ # 31))	
Connector kit (motor end) M23	EMC Connector 8 poles, M23	DE-92175
Washdown connector kit (motor end) M23	EMC Connector 8 poles, M23, stainless steel	DE-201810
Connector kit (motor end) M40	EMC Connector 6 poles, M40	DE-201601

9.10.2.1 Order codes motor cables for S303, S306, S310 (115/230V)

NOTE

Column Max. Current: according to EN60204, table 6, installation type B2.

Cables for AKM1...7 (connector options B, C, G)

M23	Article	Cable Type	Max. Current	Order Code
	Motor cable (230V) 5m	(4x1)	10.1	DE-107485
	Motor cable (230V) 10m	(4x1)	10.1	DE-107486
	Motor cable (230V) 15m	(4x1)	10.1	DE-107487
	Motor cable (230V) 20m	(4x1)	10.1	DE-107488
	Motor cable (230V) 25m	(4x1)	10.1	DE-107489
	Motor cable (230V) 5m	(4x1+(2x0.75))	10.1 / 8.5	DE-107491
	Motor cable (230V) 10m	(4x1+(2x0.75))	10.1 / 8.5	DE-107492
	Motor cable (230V) 15m	(4x1+(2x0.75))	10.1 / 8.5	DE-107493
	Motor cable (230V) 20m	(4x1+(2x0.75))	10.1 / 8.5	DE-107494
	Motor cable (230V) 25m	(4x1+(2x0.75))	10.1 / 8.5	DE-107495

Cables for AKM1 (connector option Y)

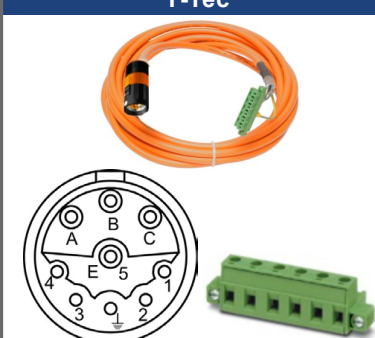
Y-Tec	Article	Order code
	Motor cable (4x1)	CM05A3-010-vvv-00
	Motor cable (4x1+(2x1))	CM15A3-010-vvv-00
	Motor cable (4x1,5)	CM05A3-015-vvv-00
	Motor cable (4x1,5+(2x1))	CM15A3-015-vvv-00
	Define the required length in clear text. Steps of 1m up to 25m. Length definition vvv=meters	

9.10.2.2 Order codes motor cables for S341, S343, S346 (400/480V)

NOTE Column Max. Current: according to EN60204, table 6, installation type B2.

Cables for AKM1 ...7 (connector options B, C, G) with shield clamp

M23	Article	Cable Type	Max. Current	Order Code
	Motor cable (400V) 5m	(4x1)	10.1	DE-107473
	Motor cable (400V) 10m	(4x1)	10.1	DE-107474
	Motor cable (400V) 15m	(4x1)	10.1	DE-107475
	Motor cable (400V) 20m	(4x1)	10.1	DE-107476
	Motor cable (400V) 25m	(4x1)	10.1	DE-107477
	Motor cable (400V) 5m	(4x1+(2x0.75))	10.1 / 8.5	DE-107479
	Motor cable (400V) 10m	(4x1+(2x0.75))	10.1 / 8.5	DE-107480
	Motor cable (400V) 15m	(4x1+(2x0.75))	10.1 / 8.5	DE-107481
	Motor cable (400V) 20m	(4x1+(2x0.75))	10.1 / 8.5	DE-107482
	Motor cable (400V) 25m	(4x1+(2x0.75))	10.1 / 8.5	DE-107483

Cables for AKM1 (connector option Y) with shield clamp

Y-Tec	Article	Order code
	Motor cable (4x1)	CM06A3-010-vvv-00
	Motor cable (4x1+(2x1))	CM16A3-010-vvv-00
	Motor cable (4x1,5)	CM06A3-015-vvv-00
	Motor cable (4x1,5+(2x1))	CM16A3-015-vvv-00
	Define the required length in clear text . Steps of 1m up to 25m. Length definition vvv=meters	

9.10.2.3 Order codes motor cables for S400

NOTE

Column Max. Current: according to EN60204, table 6, installation type B2.

Cables for AKM1...7 (connector options B, C, G) with shield clamp

M23	Article	Cable Type	Max. Current	Order Code
	Motor cable 5m	(4x1)	10.1	DE-102575
	Motor cable 10m	(4x1)	10.1	DE-102576
	Motor cable 15m	(4x1)	10.1	DE-102806
	Motor cable 20m	(4x1)	10.1	DE-102807
	Motor cable 25m	(4x1)	10.1	DE-102808
	Motor cable 5m	(4x1+(2x0.75))	10.1 / 8.5	DE-102579
	Motor cable 10m	(4x1+(2x0.75))	10.1 / 8.5	DE-102580
	Motor cable 15m	(4x1+(2x0.75))	10.1 / 8.5	DE-102809
	Motor cable 20m	(4x1+(2x0.75))	10.1 / 8.5	DE-102810
	Motor cable 25m	(4x1+(2x0.75))	10.1 / 8.5	DE-102811



Cables for AKM1 (connector option Y) with shield clamp

Y-Tec	Article	Order code
	Motor cable (4x1)	CM07A3-010-vvv-00
	Motor cable (4x1+(2x1))	CM17A3-010-vvv-00
	Motor cable (4x1,5)	CM07A3-015-vvv-00
	Motor cable (4x1,5+(2x1))	CM17A3-015-vvv-00
	Define the required length in clear text. Steps of 1m up to 25m. Length definition vvv=meters	

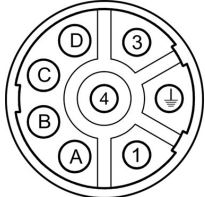

9.10.2.4 Order codes motor cables for S601...620

NOTE Column Max. Current: according to EN60204, table 6, installation type B2.

Cables for AKM1...7 (connector options B, C, G)

M23	Article	Cable Type	Max. Current	Order Code
   	Motor cable 5m	(4x1)	10.1	DE-90083
	Motor cable 10m	(4x1)	10.1	DE-90084
	Motor cable 15m	(4x1)	10.1	DE-90085
	Motor cable 20m	(4x1)	10.1	DE-90086
	Motor cable 25m	(4x1)	10.1	DE-90087
	Motor cable 5m	(4x1+(2x0.75))	10.1 / 8.5	DE-90088
	Motor cable 10m	(4x1+(2x0.75))	10.1 / 8.5	DE-90089
	Motor cable 15m	(4x1+(2x0.75))	10.1 / 8.5	DE-90090
	Motor cable 20m	(4x1+(2x0.75))	10.1 / 8.5	DE-90091
	Motor cable 25m	(4x1+(2x0.75))	10.1 / 8.5	DE-90092
	Motor cable 5m	(4x1.5)	13.1	DE-89918
	Motor cable 10m	(4x1.5)	13.1	DE-89952
	Motor cable 15m	(4x1.5)	13.1	DE-89953
	Motor cable 20m	(4x1.5)	13.1	DE-89954
	Motor cable 25m	(4x1.5)	13.1	DE-89956
	Motor cable 5m	(4x1.5+(2x0.75))	13.1 / 8.5	DE-89957
	Motor cable 10m	(4x1.5+(2x0.75))	13.1 / 8.5	DE-89961
	Motor cable 15m	(4x1.5+(2x0.75))	13.1 / 8.5	DE-89963
	Motor cable 20m	(4x1.5+(2x0.75))	13.1 / 8.5	DE-89965
	Motor cable 25m	(4x1.5+(2x0.75))	13.1 / 8.5	DE-89967
	Motor cable 5m	(4x2.5)	17.4	DE-89959
	Motor cable 10m	(4x2.5)	17.4	DE-89960
	Motor cable	15m (4x2.5)	17.4	DE-89962
	Motor cable 20m	(4x2.5)	17.4	DE-89964
	Motor cable 25m	(4x2.5)	17.4	DE-89966
Motor cable 5m	(4x2.5+(2x1))	17.4 / 10.1	DE-89968	
Motor cable 10m	(4x2.5+(2x1))	17.4 / 10.1	DE-89970	
Motor cable 15m	(4x2.5+(2x1))	17.4 / 10.1	DE-89971	
Motor cable 20m	(4x2.5+(2x1))	17.4 / 10.1	DE-89972	
Motor cable 25m	(4x2.5+(2x1))	17.4 / 10.1	DE-89969	

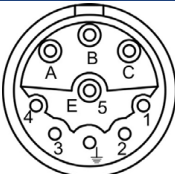
Cables for AKM1 (connector option Y)

Y-Tec	Article	Order code
   	Motor cable (4x1)	CM08A3-010-vvv-00
	Motor cable (4x1+(2x1))	CM18A3-010-vvv-00
	Motor cable (4x1,5)	CM08A3-015-vvv-00
	Motor cable (4x1,5+(2x1))	CM18A3-015-vvv-00
Define the required length in clear text. Steps of 1m up to 25m). Length definition vvv=meters		

9.10.2.5 Order codes motor cables for S701-712

NOTE

Column Max. Current: according to EN60204, table 6, installation type B2.

Cables for AKM1...7 (connector options B, C, G), with shield clamp, motor connector M23, 6 poles, up to 22A

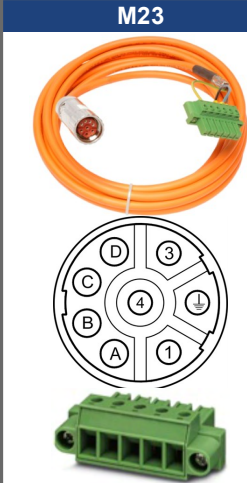
M23	Article	Cable Type	Max. Current	Order Code
	Motor cable 5m	(4x1)	10.1	DE-107473
	Motor cable 10m	(4x1)	10.1	DE-107474
	Motor cable 15m	(4x1)	10.1	DE-107475
	Motor cable 20m	(4x1)	10.1	DE-107476
	Motor cable 25m	(4x1)	10.1	DE-107477
	Motor cable 5m	(4x1+(2x0.75))	10.1 / 8.5	DE-107479
	Motor cable 10m	(4x1+(2x0.75))	10.1 / 8.5	DE-107480
	Motor cable 15m	(4x1+(2x0.75))	10.1 / 8.5	DE-107481
	Motor cable 20m	(4x1+(2x0.75))	10.1 / 8.5	DE-107482
	Motor cable 25m	(4x1+(2x0.75))	10.1 / 8.5	DE-107483

Cables for AKM1 (connector option Y), with shield clamp, motor connector y-tec

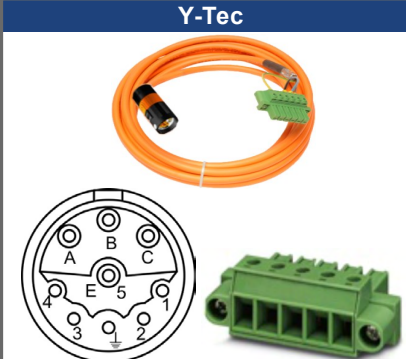
Y-Tec	Article	Order code
	Motor cable (4x1)	CM06A3-010-vvv-00
	Motor cable (4x1+(2x1))	CM16A3-010-vvv-00
	Motor cable (4x1,5)	CM06A3-015-vvv-00
	Motor cable (4x1,5+(2x1))	CM16A3-015-vvv-00
	Define the required length in clear text. Steps of 1m up to 25m). Length definition vvv=meters	

**Cables for AKM2...7 (connector options B, C, G),
with shield plate, motor connector M23, 6 poles, up to 22A**



M23	Article	Cable Type	Max. Current	Order Code
  	Motor cable 5m	(4x1.5)	13.1	DE-200456
	Motor cable 10m	(4x1.5)	13.1	DE-200457
	Motor cable 15m	(4x1.5)	13.1	DE-200458
	Motor cable 20m	(4x1.5)	13.1	DE-200459
	Motor cable 25m	(4x1.5)	13.1	DE-200460
	Motor cable 5m	(4x1.5+(2x0.75))	13.1 / 8.5	DE-200462
	Motor cable 10m	(4x1.5+(2x0.75))	13.1 / 8.5	DE-200463
	Motor cable 15m	(4x1.5+(2x0.75))	13.1 / 8.5	DE-200464
	Motor cable 20m	(4x1.5+(2x0.75))	13.1 / 8.5	DE-200465
	Motor cable 25m	(4x1.5+(2x0.75))	13.1 / 8.5	DE-200466
	Motor cable 5m	(4x2.5)	17.4	DE-200468
	Motor cable 10m	(4x2.5)	17.4	DE-200469
	Motor cable 15m	(4x2.5)	17.4	DE-200470
	Motor cable 20m	(4x2.5)	17.4	DE-200471
	Motor cable 25m	(4x2.5)	17.4	DE-200472
	Motor cable 5m	(4x2.5+(2x1))	17.4 / 10.1	DE-200474
	Motor cable 10m	(4x2.5+(2x1))	17.4 / 10.1	DE-200475
	Motor cable 15m	(4x2.5+(2x1))	17.4 / 10.1	DE-200476
	Motor cable 20m	(4x2.5+(2x1))	17.4 / 10.1	DE-200477
	Motor cable 25m	(4x2.5+(2x1))	17.4 / 10.1	DE-200478
	Motor cable 5m	(4x4)	23	DE-200618
	Motor cable 10m	(4x4)	23	DE-200619
	Motor cable 15m	(4x4)	23	DE-200620
	Motor cable 20m	(4x4)	23	DE-200621
	Motor cable 25m	(4x4)	23	DE-200622
	Motor cable 5m	(4x4+(2x1))	23 / 10.1	DE-200623
	Motor cable 10m	(4x4+(2x1))	23 / 10.1	DE-200624
	Motor cable 15m	(4x4+(2x1))	23 / 10.1	DE-200625
	Motor cable 20m	(4x4+(2x1))	23 / 10.1	DE-200626
	Motor cable 25m	(4x4+(2x1))	23 / 10.1	DE-200627

9.10.2.6 Order codes motor cables for S724

NOTE

Column Max. Current: according to EN60204, table 6, installation type B2.

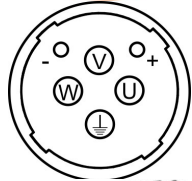
Cables for AKM7 and AKM82 (connector option H), with shield plate, motor connector M40, 6 poles



M23	Article	Cable Type	Max. Current	Order Code
  	Motor cable 5m	(4x6)	30	DE-201678
	Motor cable 10m	(4x6)	30	DE-201679
	Motor cable 15m	(4x6)	30	DE-201680
	Motor cable 20m	(4x6)	30	DE-201681
	Motor cable 25m	(4x6)	30	DE-201682
	Motor cable 5m	(4x6+(2x1.5))	30 / 13.1	DE-201683
	Motor cable 10m	(4x6+(2x1.5))	30 / 13.1	DE-201684
	Motor cable 15m	(4x6+(2x1.5))	30 / 13.1	DE-201685
	Motor cable 20m	(4x6+(2x1.5))	30 / 13.1	DE-201686
	Motor cable 25m	(4x6+(2x1.5))	30 / 13.1	DE-201687

9.10.2.7 Order codes motor cables for S748/772

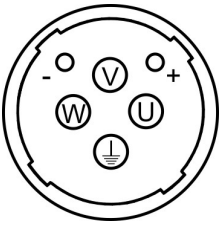

NOTE

Column Max. Current: according to EN60204, table 6, installation type B2.

Cables for AKM7 and AKM82 (connector option H), wire end ferrules at amplifier's end, motor connector M40, 6 poles

M40	Article	Cable Type	Max. Current	Order Code
  	Motor cable 5m	(4x10)	40	DE-201589
	Motor cable 10m	(4x10)	40	DE-201590
	Motor cable 15m	(4x10)	40	DE-201591
	Motor cable 20m	(4x10)	40	DE-201592
	Motor cable 25m	(4x10)	40	DE-201593
	Motor cable 5m	(4x10+(2x1.5))	40 / 13.1	DE-201594
	Motor cable 10m	(4x10+(2x1.5))	40 / 13.1	DE-201595
	Motor cable 15m	(4x10+(2x1.5))	40 / 13.1	DE-201596
	Motor cable 20m	(4x10+(2x1.5))	40 / 13.1	DE-201597
	Motor cable 25m	(4x10+(2x1.5))	40 / 13.1	DE-201598
	Motor cable 5m	(4x16)	54	DE-201688
	Motor cable 10m	(4x16)	54	DE-201689
	Motor cable 15m	(4x16)	54	DE-201690
	Motor cable 20m	(4x16)	54	DE-201691
	Motor cable 25m	(4x16)	54	DE-201692
	Motor cable 5m	(4x16+(2x1.5))	54 / 13.1	DE-201693
	Motor cable 10m	(4x16+(2x1.5))	54 / 13.1	DE-201694
	Motor cable 15m	(4x16+(2x1.5))	54 / 13.1	DE-201695
Motor cable 20m	(4x16+(2x1.5))	54 / 13.1	DE-201696	
Motor cable 25m	(4x16+(2x1.5))	54 / 13.1	DE-201697	

**Cables for AKM8 (connector option T),
wire end ferrules on amplifier's end, motor end cut off for motors with terminal box**

M40	Article	Cable type	Max. Current	Order Code
 	Motor cable 5m	(4x10)	40	DE-201698
	Motor cable 10m	(4x10)	40	DE-201699
	Motor cable 15m	(4x10)	40	DE-201700
	Motor cable 20m	(4x10)	40	DE-201701
	Motor cable 25m	(4x10)	40	DE-201702
	Motor cable 5m	(4x10+(2x1.5))	40 / 13.1	DE-201713
	Motor cable 10m	(4x10+(2x1.5))	40 / 13.1	DE-201714
	Motor cable 15m	(4x10+(2x1.5))	40 / 13.1	DE-201715
	Motor cable 20m	(4x10+(2x1.5))	40 / 13.1	DE-201774
	Motor cable 25m	(4x10+(2x1.5))	40 / 13.1	DE-201775
	Motor cable 5m	(4x16)	54	DE-201703
	Motor cable 10m	(4x16)	54	DE-201704
	Motor cable 15m	(4x16)	54	DE-201705
	Motor cable 20m	(4x16)	54	DE-201706
	Motor cable 25m	(4x16)	54	DE-201707
	Motor cable 5m	(4x16+(2x1.5))	54 / 13.1	DE-201776
	Motor cable 10m	(4x16+(2x1.5))	54 / 13.1	DE-201745
	Motor cable 15m	(4x16+(2x1.5))	54 / 13.1	DE-201746
	Motor cable 20m	(4x16+(2x1.5))	54 / 13.1	DE-201747
	Motor cable 25m	(4x16+(2x1.5))	54 / 13.1	DE-201748
	Motor cable 5m	(4x25)	70	DE-201708
	Motor cable 10m	(4x25)	70	DE-201709
	Motor cable 15m	(4x25)	70	DE-201710
	Motor cable 20m	(4x25)	70	DE-201711
	Motor cable 25m	(4x25)	70	DE-201712
	Motor cable 5m	(4x25+(2x1.5))	70 / 13.1	DE-201749
	Motor cable 10m	(4x25+(2x1.5))	70 / 13.1	DE-201750
	Motor cable 15m	(4x25+(2x1.5))	70 / 13.1	DE-201751
	Motor cable 20m	(4x25+(2x1.5))	70 / 13.1	DE-201752
	Motor cable 25m	(4x25+(2x1.5))	70 / 13.1	DE-201753

9.10.3 Preparing motor cables (motor end)

9.10.3.1 Motor series AKM1...8, 6SMx7, DBL2...6, DBK with Y-Tec, M23, or M40 connector

Motors with connectors should be connected with our pre-assembled cables.

9.10.3.2 Motor series AKM8, DBL7/8 with terminal box

These motors are fitted with terminal boxes, in which there are bolts or terminals for connections. The terminal boxes have 2 screw glands, so that the power and brake cables can be routed separately. If a motor cable with integral brake is used, the unused screw gland must be replaced by a blanking plug. Please refer to the instructions manual for the motor series.

Preparing cables for terminal box, separate cables (example DBL7/8)

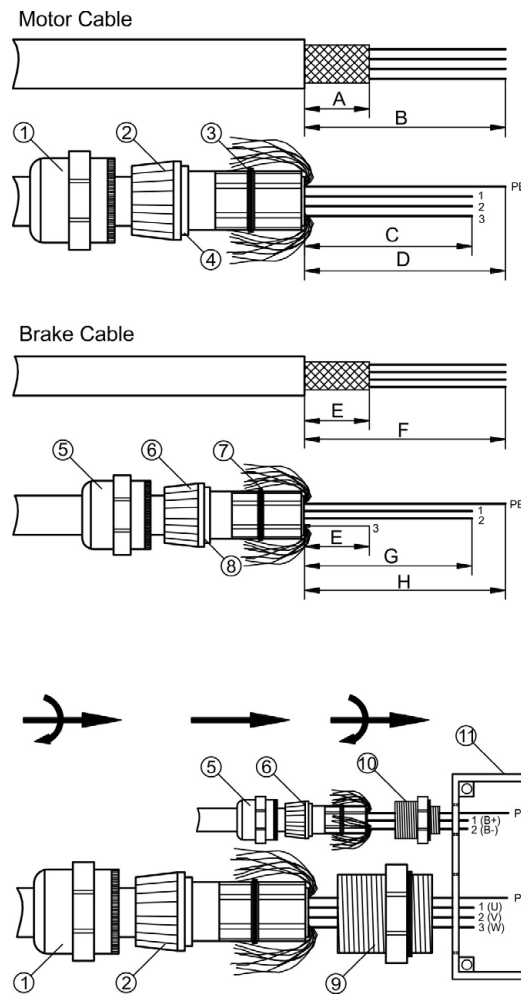

Remove the outer covering over length B, without damaging the shielding braid. Shorten the shielding braid to length A.

Push the union nut (1) and the clamping ring (2) onto the cable and push the shielding braid back over the clamping ring. The shielding braid must cover the sealing ring (3), but must not stick out over the sealing edge (4). Cut off the cores to lengths C and D.

Remove the outer covering over length F, without damaging the shielding braid. Shorten the shielding braid to length E.

Push the union nut (5) and the clamping ring (6) onto the cable and push the shielding braid back over the clamping ring. The shielding braid must cover the sealing ring (7), but must not stick out over the sealing edge (8). Cut off the cores to lengths E/G/H. Remove the insulation from core 3 and lay it over the shielding braid.

Screw the threaded sleeve (9) or (10) into the terminal box (11, example: AKM8 Motor). Push the cores of the cables and the clamping rings (2) or (6) through the threaded sleeve and screw the union nut (1) or (5) tightly onto the threaded sleeve. Then fit bootlace ferrules or terminal pins to the ends of the cores for the brake connections, and ring terminals to the power connections and the PE.

A	B	C	D	E	F	G	H	Connection
20	140	110	140	20	140	130	140	Terminals (similar to drawing)

Preparing cables for terminal box, combined cables (AKM8, DBL7/8)

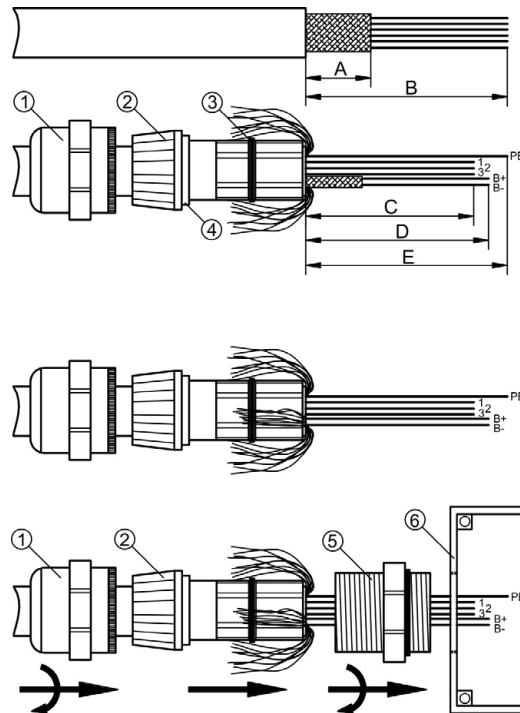

Remove the outer covering over length B, without damaging the shielding braid. Shorten the shielding braid to length A.

Push the union nut (1) and the clamping ring (2) onto the cable and push the shielding braid back over the clamping ring. The shielding braid must cover the sealing ring (3), but must not stick out over the sealing edge (4). Cut off the cores to lengths C/D/E. Shorten the shielding braid for the brake cores to length A.

Push the shielding braid for the brake cores back over the clamping ring. The braid must cover the sealing ring (3) but must not stick out over the sealing edge (4).

Screw the threaded sleeve (5) into the terminal box (6, example: AKM8 Motor). Push the cores of the cable and the clamping ring (2) through the threaded sleeve and screw the union nut (1) tightly onto the threaded sleeve.

Then fit, depending on the motor type, bootlace ferrules or ring terminals to the ends of the cores.

A	B	C	D	E	Connection
20	140	110	130	140	Terminals

9.10.4 Preparing motor cables (servo amplifier end)

Material list

Part	Description	Order code
Cable	Overview ((→ # 31))	
Connector kit amplifier end S300, 230V	Power Combicon X9	DE-107631
Connector kit amplifier end S300, 400V	Power Combicon X9	DE-107467
Connector kit amplifier end S400	Power Combicon X6	DE-107466
Connector kit amplifier end S601...620	Power Combicon X9	DE-90066
Connector kit amplifier end S701-712, S724	Power Combicon X9	DE-200453

Connection scheme

Pin assignment is described in the instructions manual for the servo amplifier.

9.10.4.1 Preparing cables for S300/S400

The motor is connected to S300 or S400 by a Power Combicon connector ((→ # 59)). Please take note that the connector can accept a maximum conductor cross-section of 4 mm².

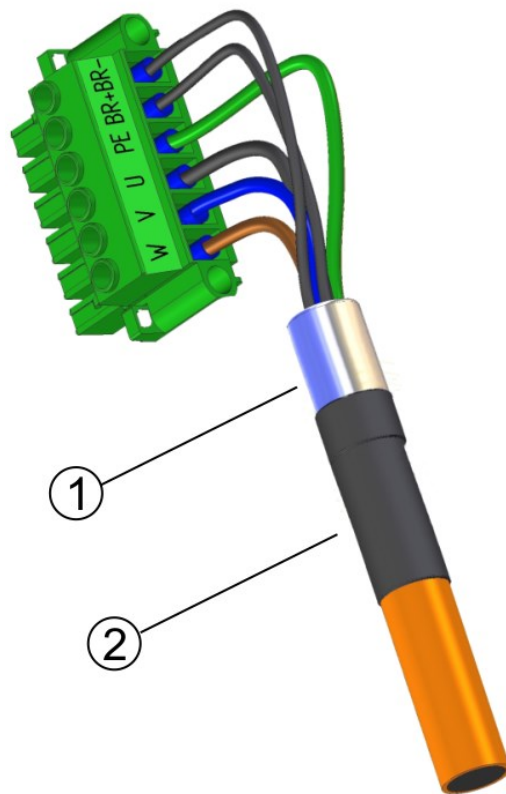

Strip the external cable sheath to a length of approximately 120 mm, taking care not to damage the braided shield. Push the braided shield (1) back over the cable and secure with a rubber sleeve (2) or shrink sleeve. Shorten all the wires apart from the protective earth (PE) wire (green/yellow) by about 20 mm so that the PE wire is now the longest wire. Strip all wires and fit wire end ferrules.

Wire the connector as shown in the connection diagram in the instructions manual. Plug in the connector to the socket on the front of the servo amplifier. Screw the connector in place.

Use a shielding clamp ((→ # 15)) to ensure an optimum shield connection to the servo amplifier.

Alternatively you can use the shield shroud of the servo amplifier. Use cable ties to attach the cable to the side shroud of the amplifier, securing the braided shield of the cable to the shroud with a cable tie.

This ensures that there is conductive contact over a large surface area between the braided shield and the front panel.

9.10.4.2 Preparing cables for S601...620

The motor is connected to the S601...620 by a Power Combicon connector (→ # 59). You can order the connector kit from Kollmorgen (connector, housing, shield plate, rubber bushes, installation material) with the order code DE-90066.

Please take note that the connector can accept a maximum conductor cross-section of 4 mm².

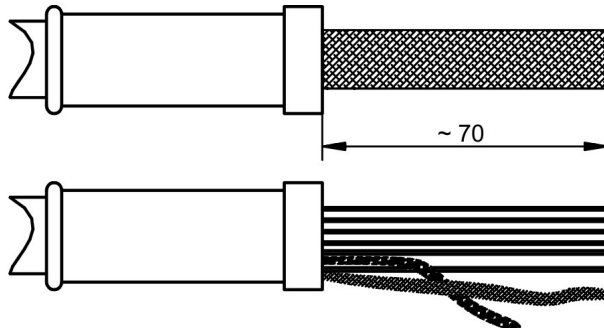

First push the rubber sleeve onto the cable, and **then** strip off about 70 mm of the outer covering, without damaging the shielding.

Carefully separate the shielding braid from the cores.

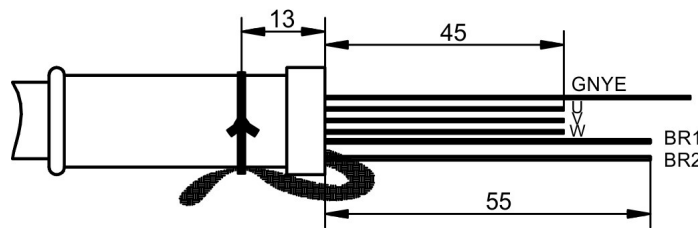

Twist the shielding braid into a pigtail and tie it to the sleeve with the wire. Shorten the brake cores to 55 mm and the power cores to 45 mm.

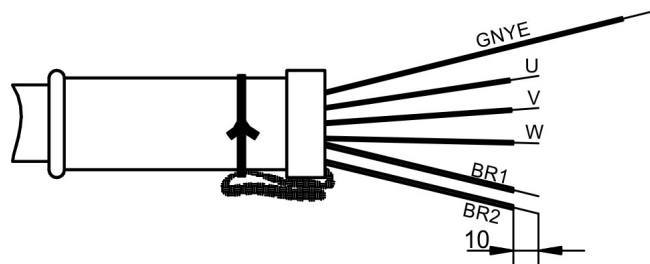

Fold back the overhanging length of the shielding pigtail to face forwards. Strip off the ends of the cores for about 10 mm. This length can vary, depending on the type of bootlace ferrule that is used.

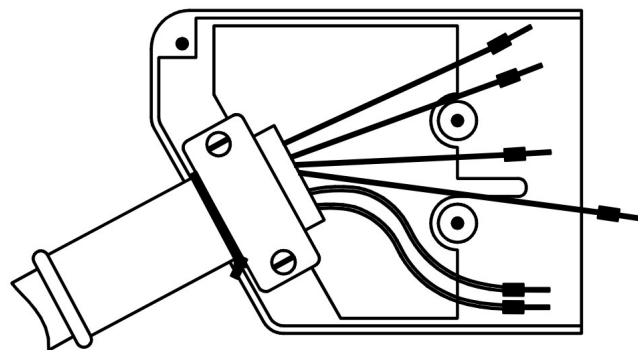

Apply bootlace ferrules to the conductors. Place the shield plate in the bottom half of the connector housing. Place the cable in the strain relief, so that the folded shielding pigtail lies on the shield plate, but the tie-wire is not clamped inside. Tighten up the screws, without crushing the cable.

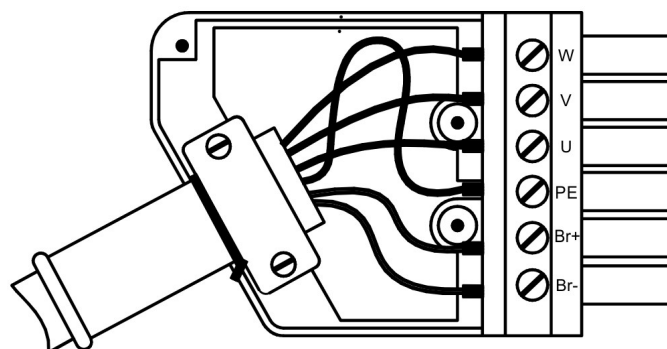

Place the connector in the housing. Take care that the tongue of the shield plate sits in the PE clamp. Wire up the connector according to the wiring diagram in the instructions manual, and tighten up the clamping screws. Take care that the insulation is not trapped underneath. Close the housing.

9.10.4.3 Preparing cables for S701...724

The motor is connected to the S701...724 by a Power Combicon connector (→ # 59). You can order the connector kit from Kollmorgen (connector, housing, shield plate, rubber bushes, installation material) with the order code DE-200453. Please take note that the connector can accept a maximum conductor cross-section of 6 mm².

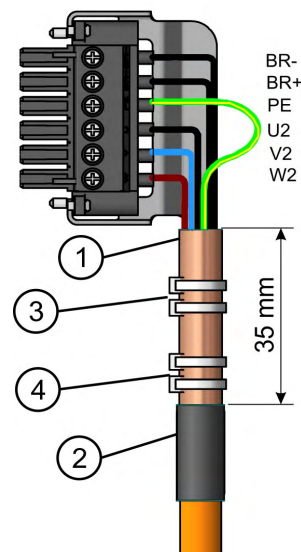

Strip the external cable sheath to a length of approx. 120 mm, taking care not to damage the braided shield. Push the braided shield (1) back over the cable and secure with a rubber sleeve (2) or shrink sleeve.

Shorten all the wires apart from the protective earth (PE) wire (green/yellow) by about 20 mm so that the PE wire is now the longest wire. Strip all wires and fit wire end ferrules.

Secure the braided shield of the cable to the shroud with a cable tie or a hose clamp (3) and use a second tie (4) to fasten the cable.

Wire the connector as shown in the connection diagram. Plug in the connector to the socket on the front of the S701...724.

Screw the connector in place. This ensures that there is conductive contact over a large surface area between the braided shield and the front panel.

9.10.4.4 Preparing cables for S748/772

Motor Power Cable

The motor is connected to the S748/772 by terminals. The cable material depends on the motor that is used. Please refer to the instructions manual for the corresponding motor series.

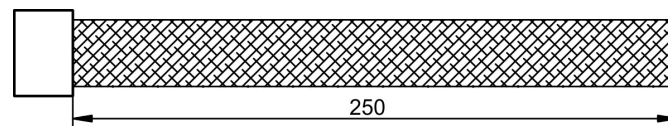

Please take note that the terminals can accept a core cross-sections of 10 to 50 mm².

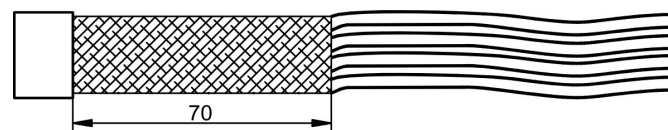

Remove the outer covering over a length of 250 mm, without damaging the shielding braid.

Shorten the shielding braid to a length of 70 mm.

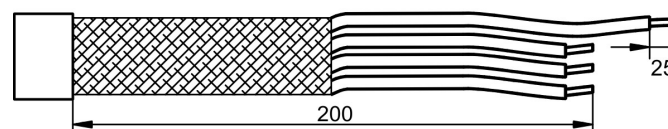

Shorten the cores for the power connections to 200 mm. Strip off about 25 mm of the insulation from all cores.

The length varies with the conductor cross-section and the type of bootlace ferrule that is used.

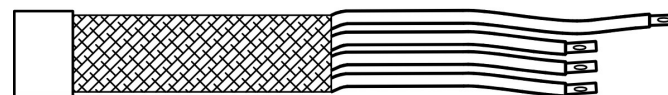

Apply bootlace ferrules to the conductors. Do not use terminal pins, because their cross-section is too small.

Holding Brake Cable

S748/772

The electric holding brake of the motor is connected via connector X9A. It is therefore necessary to wire the power and brake cables separately. The 24V power supply for the holding brake is connected via connector X9B (→ # 38).

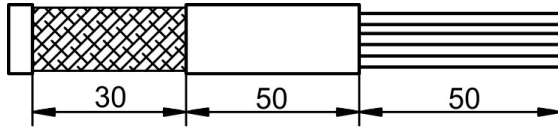

Remove the outer covering of the cable and the shielding braid over a length of about 50 mm. Then remove the outer covering without damaging the shielding braid.

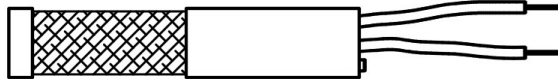

Shorten the redundant lines of the cable as far as possible. Strip off about 10 mm of the insulation from the ends of the cores. Take care to avoid damage to the copper strands while doing this. Depending on the cross-section of the core and the type of bootlace ferrule that is used, the length that has to be stripped may vary by several millimeters.

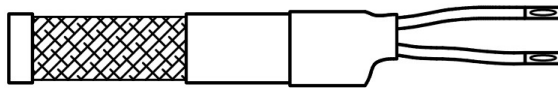

Protect the redundant lines by pushing a 30 mm long heat shrink sleeve half over the outside cover and heat it up. Apply bootlace ferrules to the conductors. As an alternative, you can also use terminal pins instead of bootlace ferrules.



Push the ends of the conductors into the connector as far as they will go. Follow the pin assignment in the instructions manual. Tighten the screws of the terminals. Take care that the insulation is not trapped in the terminals.

9.11 Motor Feedback Cables

The motor feedback should be connected with pre-assembled Kollmorgen cables. The cable shield is connected to servo amplifier and motor via the connector housings. Pin assignment is described in the instructions manual for the servo amplifier.

Technical data of the used cable material can be found on (→ # 31)

9.11.1 Resolver cables

The servo amplifiers have a 9 pole Sub-D female connector for the connection of a resolver and the thermal protection sensor.

Cables for AKM1...8 (connector options B, C, G)

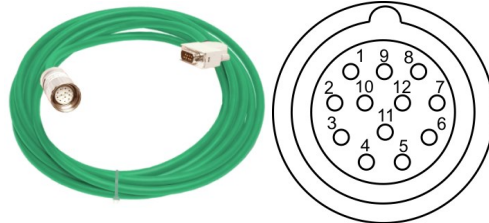

All our standard motors feature the same 12-pin connector (M23) for the resolver connection.

(4x(2x0.25))	Cable Length	Order Code
Resolver cable M23	5 m	DE-84972
Resolver cable M23	10 m	DE-84973
Resolver cable M23	15 m	DE-84974
Resolver cable M23	20 m	DE-84975
Resolver cable M23	30 m	DE-84976

Material list	Designation	Order code
Cable (cut to length)	LiYCY (TP) 4x2x0.25	DE-92186
Connector kit, motor end	EMC Connector M23, 12 pole	DE-90210
Washdown connector kit, motor end	EMC Connector M23, 12 pole, stainless steel	DE-201811
Connector kit, amplifier end	Socket 9-poles, housing and screws	DE-81784

Cables for AKM1 (connector option Y)

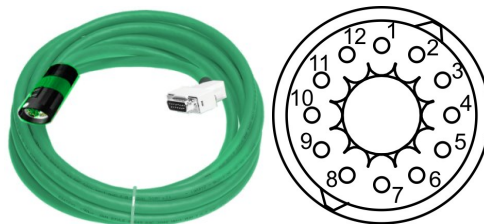

The AKM1 motor optionally supports a y-tec connector.

Length definition: vvv=meters.

Maximum cable length: 100 m.

(4x(2x0.25))	Cable Length	Order code
Resolver Cable y-tec	Steps of 1m up to 100m	CFR3A3-002-vvv-00

Material list	Designation	Order code
Cable (cut to length)	LiYCY (TP) 4x2x0.25	DE-92186
Connector kit, amplifier end	Socket 9-poles, housing and screws	DE-81784

9.11.2 Encoder cables

The servo amplifiers have a 15 pole Sub-D female connector for the connection of the encoder and the thermal protection sensor.

Cables for AKM1...8 (connector options B, C, G)

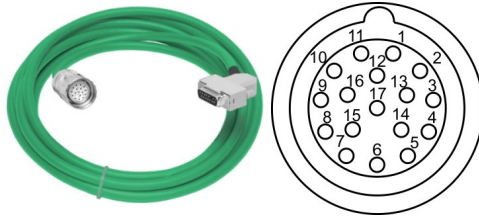

All our standard motors feature the same 17-pin connector (M23) for the encoder connection (EnDat, HIPERFACE, BiSS etc.).

(7x(2x0.25))	Cable Length	Order Code
Encoder cable	5 m	DE-90287
Encoder cable	10 m	DE-91019
Encoder cable	15 m	DE-91811
Encoder cable	20 m	DE-91807
Encoder cable	25 m	DE-92205

Material list	Description	Order code
Cable (cut to length)	LiYCY (TP) 7x2x0.25mm ²	DE-100904
Connector kit, motor end	EMC Connector M23, 17 poles	DE-85267
Washdown connector kit, motor end	EMC Connector M23, 17 poles, stainless steel	DE-201820
Connector kit, amplifier end	Socket 15 poles, housing and screws	DE-103440

Cables for AKM1 (connector option Y)

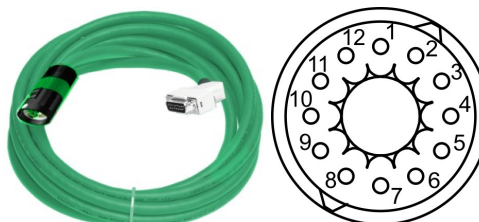

The AKM1 motor optionally supports a y-tec connector.

Length definition: vvv=meters.

Maximum cable length: 50 m.

(7x(2x0.25))	Cable Length	Order code
Hiperface cable y-tec	Steps of 1 m up to 50 m	CFH2A3-002- vvv-00

Material list	Description	Order code
Cable (cut to length)	LiYCY (TP) 7x2x0.25mm ²	DE-100904
Connector kit, amplifier end	Socket 15 poles, housing and screws	DE-103440

9.11.3 ComCoder cables

The servo amplifiers have a 15 pole Sub-D female connector for the connection of the com-coder (incremental encoder with Hall sensors) and the thermal protection sensor.

Cables for AKM1...8 (connector options B, C, G)

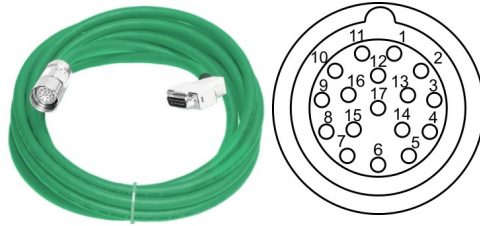

All our standard motors in our range feature the same 17-pin M23 connector for the ComCoder connection.

(8x(2x0.25))	Cable Length	Order Code
ComCoder cable	5 m	DE-107915
ComCoder cable	10 m	DE-107916
ComCoder cable	15 m	DE-107917
ComCoder cable	20 m	DE-107918
ComCoder cable	25 m	DE-107919

Material list	Description	Order code
Cable (cut to length)	LiYCY (TP) 8x2x0.25mm ²	DE-108012
Connector kit, motor end	EMC Connector, M23, 17 poles	DE-85267
Washdown connector kit, motor end	EMC Connector M23, 17 poles, stainless steel	DE-201820
Connector kit, amplifier end	Socket 15-poles, housing and screws	DE-103440

Cables for AKM1 (connector option Y)

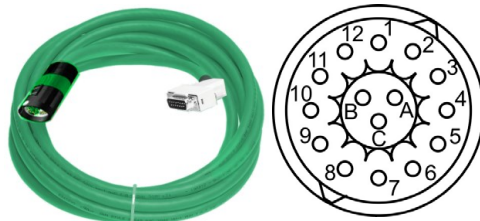

The AKM1 motor optionally supports a y-tec connector.

Length definition: vvv=meters.

Maximum cable length: 25 m.

(7x(2x0.25))	Cable Length	Order code
Comcoder cable y-tec	Steps of 1 m up to 25 m	CFC2A3-002- vvv-00

Material list	Description	Order code
Cable (cut to length)	LiYCY (TP) 8x2x0.25mm ²	DE-108012
Connector kit, amplifier end	Socket 15-poles, housing and screws	DE-103440

Service

We are committed to quality customer service. In order to serve in the most effective way, please contact your local sales representative for assistance.

If you are unaware of your local sales representative, please contact the Customer Support.



Join the [Kollmorgen Developer Network](#) for product support. Ask the community questions, search the knowledge base for answers, get downloads, and suggest improvements.



Europe

KOLLMORGEN

Internet: www.kollmorgen.com/uk

E-Mail: technik@kollmorgen.com

Tel.: +49 - 2102 - 9394 - 0

Fax: +49 - 2102 - 9394 - 3155



North America

KOLLMORGEN

Internet: www.kollmorgen.com/en-us

E-Mail: support@kollmorgen.com

Tel.: +1 - 540 - 633 - 3545

Fax: +1 - 540 - 639 - 4162



South America

KOLLMORGEN

Internet: www.kollmorgen.com/pt-br

E-Mail: contato@kollmorgen.com

Tel.: +55 - 11 - 4615-6300



Asia

KOLLMORGEN

Internet: www.kollmorgen.cn

E-Mail: sales.china@kollmorgen.com

Tel: +86 - 400 668 2802

Fax: +86 - 21 6248 5367



KOLLMORGEN

Because Motion Matters™