

**INSTALLATION
INSTRUCTIONS
for
SLO-SYN[®]
MODELS SS2000MD7 &
SS2000MD7-128
TRANSLATOR/DRIVE**



TABLE OF CONTENTS

	Page
THINGS TO KNOW BEFORE USING THIS EQUIPMENT	3
WARRANTY RESTRICTIONS	3
SECTION 1: INTRODUCTION	3
1.1 Using This Manual	3
1.2 Product Features	4
SECTION 2: EXPRESS START UP PROCEDURE	5
SECTION 3: INSTALLATION GUIDELINES	6
3.1 Mounting	6
3.2 Connector Locations And Pin Assignments	7
SECTION 4: SPECIFICATIONS	11
4.1 Mechanical Specifications	11
4.2 Electrical Specifications	11
4.3 Environmental Specifications.....	12
4.4 Motor Compatibility	12
4.5 Current Settings	14
4.6 Step Resolution.....	14
4.7 Signal Specifications.....	15
4.8 Indicator Lights.....	18
SECTION 5: TORQUE VERSUS SPEED CHARACTERISTICS	18
5.1 Motor Performance	18
5.2 Typical Torque Vs. Speed Curves	19
SECTION 6: TROUBLESHOOTING	29
APPENDIX A: TROUBLESHOOTING ELECTRICAL INTERFERENCE PROBLEMS	31

THINGS TO KNOW BEFORE USING THIS EQUIPMENT

- Only qualified personnel should install or perform servicing procedures on this equipment. Do not operate the unit without the enclosures in place as voltage present in this unit can cause serious or fatal injury.
- Before performing any work on the unit, allow at least five minutes for the capacitors to discharge fully.
- Voltage is present on unprotected pins when unit is operational.
- The "PWR ON" LED must be off for approximately 30 seconds before making or breaking the motor connections.
- Motors powered by this drive may develop extremely high torque. Be sure to disconnect power to this drive before doing any mechanical work.

CAUTION:

This unit is designed for 24 to 75 Vdc input only (see Section 4.2, Electrical Specifications, Page 11).

WARRANTY RESTRICTIONS

Reconfiguration of the circuit in any fashion not shown in this manual will void the Warranty.

Failure to follow the installation guidelines as described in Section 3 will void the Warranty.

SECTION 1: INTRODUCTION

1.1 USING THIS MANUAL

It is important that you understand how this SLO-SYN SS2000MD7 Translator/Drive is installed and operated before you attempt to use it.

We strongly recommend that you read this manual completely before proceeding with the installation of this unit.

This manual is an installation and operating guide to the SLO-SYN SS2000MD7 Translator/Drive. Section 1 gives an overview of the Drive and its features. Section 2 describes the steps necessary to place the drive into operation. General wiring guidelines as well as the physical mounting of the unit and connections to the drive portion are covered in Section 3.

Complete specifications, listed in Section 4, provide easily referenced information concerning electrical, mechanical and environmental specifications. The procedure for setting the motor current level is also covered in this section.

Torque versus speed characteristics with all appropriate SLO-SYN Stepper Motors are given in Section 5. Section 6, Troubleshooting, gives procedures to follow if the Translator/Drive fails to operate properly.

Appendix A provides procedures for troubleshooting electrical interference problems.

1.2 PRODUCT FEATURES

The SLO-SYN SS2000MD7(MD7-128) Translator/Drive is a bipolar, speed adjustable, two-phase PWM drive which uses power MOSFET devices. The MD7 can be set to operate a stepper motor in 1/2, 1/10, 1/25 or 1/100 microsteps. The MD7-128 can be set to operate a stepper motor in Full, 1/16, 1/64, or 1/128 microsteps. The maximum running speed is 3,000 rpm. To reduce the chances of electrical noise problems, the control signals are optically isolated from the drive circuit.

- UL recognized under Component Program, File #E146240
- Switch selectable current levels of 1 through 7 amperes
- Full short circuit protection (phase-to-phase and phase-to-ground)
- Undervoltage and transient overvoltage protection
- Thermal protection
- Efficient thermal design
- Optically isolated inputs
- Reduce Current and Windings Off capabilities
- Switch selectable step resolution
- Compact size
- Sturdy all-aluminum case

SECTION 2: EXPRESS START UP PROCEDURE

The following instructions define the minimum steps necessary to make your **Drive** operational.

CAUTION:

Always disconnect the power to the unit and be certain that the "PWR ON" LED is OFF before connecting or disconnecting the motor leads. FAILURE TO DO THIS WILL RESULT IN A SHOCK HAZARD AND MAY DAMAGE THE DRIVE.

Always operate the unit with the Motor and the Drive enclosure GROUNDED. Be sure to twist together the wires for each motor phase as well as those for the dc input. Six twists per foot is a good guideline.

1. Check to see that the motor used is compatible with the drive. Refer to Section 4.4 for a list of compatible motors.
2. Set the correct current level for the motor being used per the instructions in Section 4.5. **Heat sinking is required if a current of 4 amperes or higher is used.**
3. Select the appropriate step resolution and set the switches as described in Section 4.6.
4. Wire the motor per the "Motor Connections" description in Section 3.2.
5. Connect the power source to the DC input terminal strip. Be sure to follow the instructions for connecting the filter capacitor as described in Section 3.2, under Power Input.

NOTES:

If the motor operates erratically, refer to Section 5, "Torque Versus Speed Characteristics".

Clockwise and counterclockwise directions are properly oriented when viewing the motor from the end opposite the mounting flange.

SECTION 3: INSTALLATION GUIDELINES

3.1 MOUNTING

The SLO-SYN Drive is mounted by fastening its mounting brackets to a flat surface as shown in Figure 3.1. If the Heat Sink Assembly, part number 221576-001, is mounted against a bulkhead, be sure to apply a thin coating of thermal compound between the heat sink and the mounting surface before fastening the unit in place. Do not use too much thermal compound. It is better to use too little than too much.

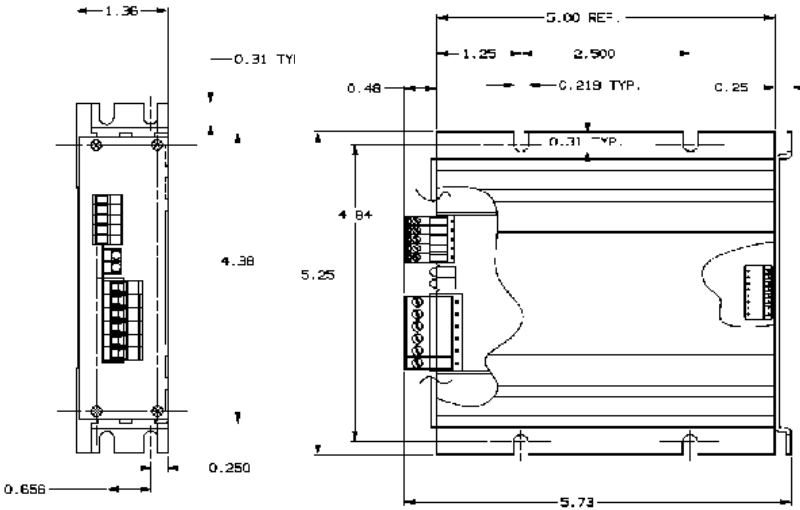

Figure 3.1, Mounting Diagram

NOTE: Case temperature should not exceed +70° C (+158° F). A heat sink, such as Superior Electric Heat Sink Assembly 221576-001, must be used when the drive is operated at a current setting of 4 amperes or more. In this case the unit should be mounted upright (with the cooling fins vertical), or proper cooling will not occur. Air flow should not be obstructed. Forced air cooling may be required to maintain temperature within the stated limits.

When selecting a mounting location, it is important to leave at least two inches (51mm) of space around the top, bottom and sides of the unit to allow proper airflow for cooling.

It is also important to keep the drive away from obvious noise sources. If possible, locate the drive in its own metal enclosure to shield it and its wiring from electrical noise sources. If this cannot be done, keep the drive at least three feet from any noise sources.

3.2CONNECTOR LOCATIONS AND PIN ASSIGNMENTS

Figure 3.2 shows the connector locations for the SLO-SYN SS2000MD7 Translator/Drive.

Figure 3.2, Connector Locations
MOTOR CONNECTIONS

All motor connections are made via the 6-pin connector, part number 218397-006. Pin assignments for this connector are given below. Motor connections are shown in Figure 3.3.

<u>Pin</u>	<u>Assignment</u>
1	M1 (Phase A)
2	M3 (Phase A)
3	M4 (Phase B)
4	M5 (Phase B)

NOTE: Motor phase A is M1 and M3 and motor phase B is M4 and M5. The motor frame must be grounded.

Cabling from the drive to the motor should be done with a shielded, twisted-pair cable. As a guideline, the wires for each motor phase should be twisted about six times per foot.

Superior Electric offers the following motor cable configurations. These cables have unterminated leads on both ends.

Length	Part Number
10 ft (3 m)	216022-031
25 ft (7.6 m)	216022-032
50 ft (15.2 m)	216022-033
75 ft (22.8 m)	216022-034

Figure 3.3 shows the possible motor wiring configurations.

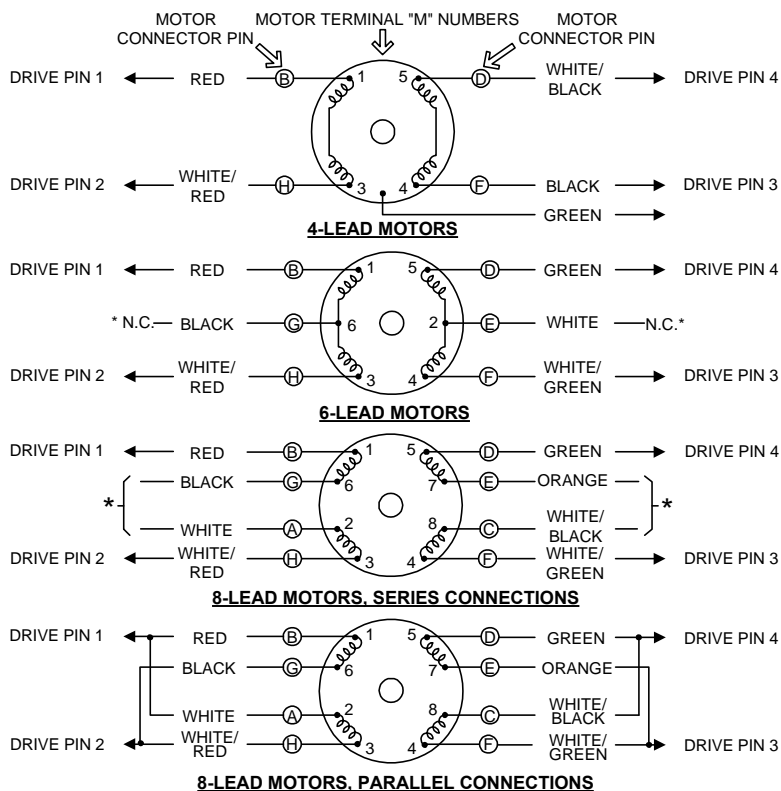

* These leads must be insulated and isolated from other leads or ground.

Circled letters identify terminals for connector motors, numbers identify those for terminal box motors.

Figure 3.3, Motor Wiring Configurations

POWER INPUT

The dc input power is connected to pins 5 and 6 of the power connector. Pin 5 [Vm(+)] is the power supply plus (+) connection and pin 6 [Vom(-)] is the power supply minus (-) connection.

An unregulated supply similar to that shown in Figure 3.4 is preferable. If a regulated supply is used, it must be a linear regulated supply and must be capable of operating with the added filter capacitor. A switching regulated supply is not recommended for use with this drive. It is important that capacitor (C1) be connected within three feet (0.9 meter) of the input terminals. The capacitor must be of the correct value and have the proper current and voltage parameters (see list of components on page 11).

It is recommended that the power supply leads be twisted together (6 twists per foot).

NOTE: If the power supply is grounded, it must only be grounded on the negative side or the short circuit protection will not operate properly.

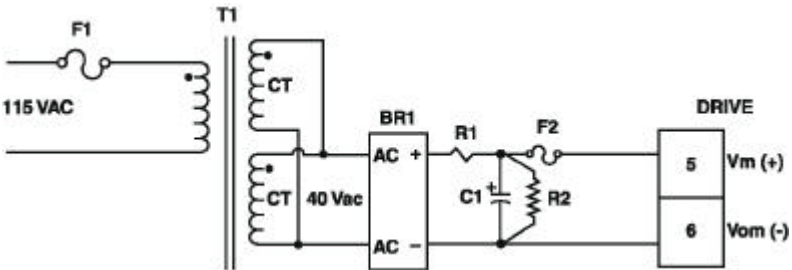

NOTES: The cable between the filter capacitor (C1) and the drive should be twisted (six twists per foot). Maximum wire length is three feet.

Use #16 AWG or larger wire.

Figure 3.4
Typical Power Supply For A Single Drive Application

Components for circuit shown in Figure 3.4:

5 ampere or lower setting

F1	3 amp., time delay, Bussman MDA-3 or equivalent
F2	15 amp. very fast acting , Bussman GBB-15 or equivalent
R1	5 ohm surge limiter, Phillips 2322-654-61508 or equivalent
R2	4.7k ohm, 2 watts, $\pm 5\%$
T1	160 VA, Bicron Electronics BU216AS040D, Signal Transformer 80-2 or equivalent
BR1	General Instrument GBPC3502 or equivalent
C1	4700 μf, 6.9 amp. ripple current, 100 Vdc, United ChemiCon 36DA472F100AL2A or equivalent

6 and 7 ampere settings

F1	6 amp. time delay, Bussman MDA-6 or equivalent
F2	15 amp. very fast acting, Bussman GBB-15 or equivalent
R1	4 ohm surge limiter, Phillips 2322-654-61408 or equivalent
R2	4.7k ohm, 2 watts, $\pm 5\%$
T1	320 VA, Bicron Electronics BU233AS040D, Signal Transformer 80-4 or equivalent
BR1	General Instrument GBPC3502 or equivalent
C1	6800 μf , 9.4 amp. ripple current, 100 Vdc, United Chemi-Con 36DA682F100AD2A or equivalent

SECTION 4: SPECIFICATIONS

4.1 MECHANICAL SPECIFICATIONS

Size

(Inches)..... 4.375 H x 1.36 W x 5.73 D

(mm) 111 H x 35 W x 146 D

Weight..... 1.5 pounds (680 grams)

4.2 ELECTRICAL SPECIFICATIONS

DC Input Range 24 Vdc min., 75 Vdc max.

DC Current see Motor Table

Drive Power Dissipation

(Worst Case) 40 watts

4.3 ENVIRONMENTAL SPECIFICATIONS

Temperature

Operating +32° F to +122° F
(0° C to +50° C) free air ambient, Natural Convection. Maximum heat sink temperature of 158° F (70° C) must be maintained. Forced-air cooling may be required.

Storage -40° F to +167° F
..... (-40° C to +75° C)

Humidity 95% max. noncondensing

Altitude 10,000 feet (3048 m) max.

4.4 MOTOR COMPATIBILITY

Motor Types Superior Electric M and KM Series

Frame Sizes

M Series M061 (NEMA 23D) through M092 (NEMA 34)

KM series KML060 (NEMA 23) through
KML093 (NEMA 34)

Number of

Connections..... 4, 6, 8

Minimum

Inductance 1 millihenry

Maximum

Resistance = 0.25 x Vdc Supply/I Setting

Example:

Vdc = 60 I Setting = 7

R max. = 0.25 x 60/7 = 2.1 ohms

NOTE: Maximum resistance is total of motor plus cable.

CAUTION: Do not use larger frame size motor than those listed, or the drive may be damaged. If a larger frame size motor must be used, consult the factory for recommendations.

MOTORS FOR USE WITH THE SS2000MD7 TRANSLATOR/DRIVE

Motor	Winding	Connection	Current Setting (Am peres)	Power Supply Current	
				Standstill (Amps. DC)	Maximum (Amps. DC)
M061	08	Series	3	1.0	2.0
M062	09	Series	3	1.0	2.0
M062	09	Parallel	6	1.5	4.0
M063	09	Series	3	1.0	2.0
M063	09	Parallel	6	1.5	4.0
M091	09	Series	4	1.5	2.0
M091	09	Parallel	6	1.5	4.0
M092	09	Series	4	2.0	2.0
M092	09	Parallel	7	2.0	4.0
M093	14	Series	5	2.0	2.0
M093	14	Parallel	7	2.0	4.0
KML060F05	-	-	3	1.0	2.0
KML060F08	-	-	4	1.0	2.0
KML061F05	-	-	3	1.0	2.0
KML062F07	-	-	3	1.0	3.5
KML062F13	-	-	6	1.5	4.5
KML063F07	-	-	3	1.0	2.0
KML063F13	-	-	7	2.0	4.5
KML091F07	-	-	4	1.5	2.5
KML091F13	-	-	6	1.5	4.0
KML092F07	-	-	4	2.0	2.0
KML092F13	-	-	7	2.0	4.5
KML093F07	-	-	4	2.0	2.0
KML093F14	-	-	7	2.0	4.5

Power supply currents shown are measured at the output of the rectifier bridge in Figure 3.4.

M061, M062 and M063 motors listed include LS, LE, CS, FC and FD versions. M091, M092 and M093 motors include FC and FD versions with 6 or 8 leads. Motors with windings other than those listed can be used as long as the current ratings listed on the motors are not exceeded. **Consult the factory for recommendations concerning the use of M111 and M112 frame size motors.**

4.5 CURRENT SETTINGS

The proper current setting for each motor is shown on the individual torque vs. speed curves. Use this current level to obtain the torque shown. The access hole for the switches which set the motor current level is located on the back of the unit (see Figure 4.1). Switches 1 through 6 are used to select the current level. Select the desired operating current by setting the appropriate switch to position 1 (ON). The OFF position is labeled "0". Only one switch should be ON. If two or more switches are ON, the one which selects the highest current level will be the active switch. The switch settings are as follows:

Position (amperes)	Current
None	1.0
1	2.0
2	3.0
3	4.0*
4	5.0*
5	6.0*
6	7.0*

*Heat sinking is recommended at current settings of 4 amperes or higher. The drive case temperature MUST NOT exceed 70°C.

4.6 STEP RESOLUTION

The number of pulses per revolution is selected using positions 7 and 8 of the switch described in Section 4.5. The following chart shows the correct switch settings for each available step resolution.

Switch Position		Step Resolution		Pulses Per Revolution	
7	8	MD7	MD7-128	MD7	MD7-128
0	0	1/2	Full	400	200
1	0	1/10	1/16	2,000	3200
0	1	1/25	1/64	5,000	12,800
1	1	1/100	1/128	20,000	25,600

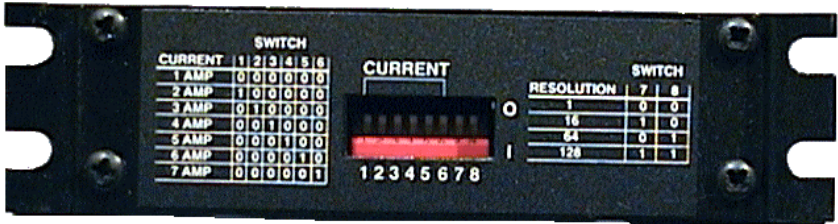

Figure 4.1
Switches For Setting Current Level
And Step Resolution

4.7 SIGNAL SPECIFICATIONS

4.7.1 Connector Pin Assignments

All connections are made via the 5-pin connector, part number 221536-005.

Pin	Assignment
1	OPTO
2	PULSE
3	DIR
4	AWO
5	RDCE

4.7.2 Signal Descriptions

OPTO Opto-Isolator Supply
 User supplied power for the opto-isolators.

PULSE Pulse Input
 A low to high transition on this pin advances the motor one step. The step size is determined by the Step Resolution switch setting.

DIR Direction Input

When this signal is high, motor rotation will be clockwise. Rotation will be counterclockwise when this signal is low.

Clockwise and counterclockwise directions are properly oriented when viewing the motor from the end opposite the mounting flange.

AWO All Windings Off Input
When this signal is low, AC and DC current to the motor will be zero. **Caution: There will be no holding torque when the AWO signal is low.**

RDCE Reduce Current Input
The motor current will be 50% of the selected value when this signal is low. **Caution: Holding torque will also be reduced when this signal is low.**

NOTE: If you are using the drive with an SS2000I or SS2000I-V control, the READY input and the OPTO input on the control must be jumpered together.

4.7.3 Level Requirements

OPTO

Voltage 4.5 to 6.0 volts dc
Current 16 mA per signal used

Other Signals

Voltage

Low 0.8 Vdc
0.0 Vdc
High OPTO
OPTO - 1 volt

Current

Low 16 mA
High 0.2 mA

4.7.4 Timing Requirements

PULSE

Max. Frequency 500 kHz
Max. Rise And
Fall Times 1 microsecond
Min. Pulse Width 1 microsecond

Other Signals

Response Time 50 microseconds

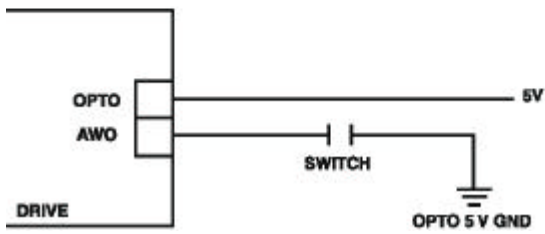
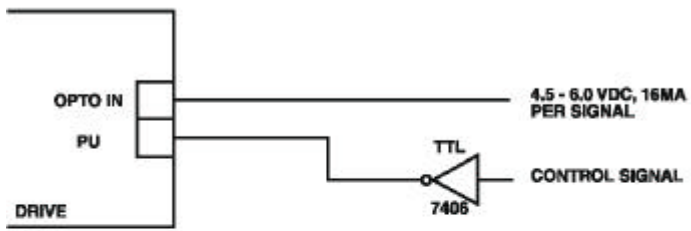
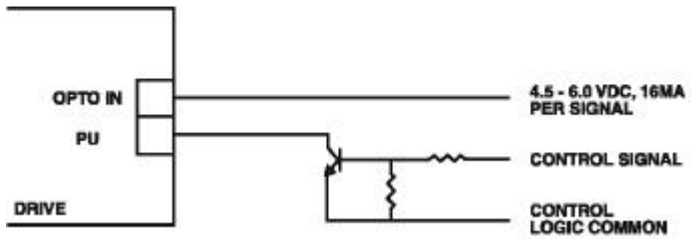
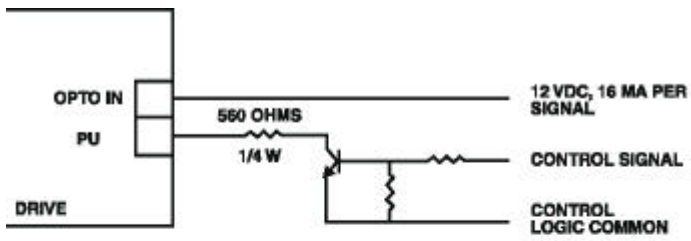

Suggested Methods For Control Interface
Figure 4.2

4.8 INDICATOR LIGHTS

"POWER" LED, Red

Lights when the drive logic power supply is present, indicating that the drive is energized.

"FAULT" LED, Red

Lights to indicate over current condition. This condition is a result of motor wiring errors or a ground fault.

Also lights to indicate the heat sink temperature has exceeded a safe level for reliable operation.

Recovery from over current or over temperature condition requires removing and then reapplying the power.

SECTION 5: TORQUE VERSUS SPEED CHARACTERISTICS

5.1 MOTOR PERFORMANCE

All stepper motors exhibit instability at their natural frequency and harmonics of that frequency. Typically, this instability will occur at speeds between 50 and 1000 full steps per second and, depending on the dynamic motor load parameters, can cause excessive velocity modulation or improper positioning. This type of instability is represented by the open area at the low end of each Torque vs. Speed curve.

There are also other instabilities which may cause a loss of torque at stepping rates outside the range of natural resonance frequencies. One such instability is broadly defined as mid-range instability. Usually, the damping of the system and acceleration/deceleration through the resonance areas aid in reducing instability to a level that provides smooth shaft velocity and accurate positioning. If instability does cause unacceptable performance under actual operating conditions, the following techniques can be used to reduce velocity modulation.

- 1) Avoid constant speed operation at the motor's unstable frequencies. Select a base speed that is above the motor's resonant frequencies and adjust acceleration and deceleration to move the motor through unstable regions quickly.
- 2) The motor winding current can be reduced as described in Section 4.5. Lowering the current will reduce torque proportionally. The reduced energy delivered to the motor can decrease velocity modulation.
- 3) Use microstepping to provide smoother operation and reduce the effects of mid range instability. Note that microstepping reduces the shaft speed for a given pulse input rate.

5.2 TYPICAL TORQUE VERSUS SPEED CURVES

NOTE: The test conditions used when obtaining the torque versus speed data are listed in the lower left-hand corner of each curve.

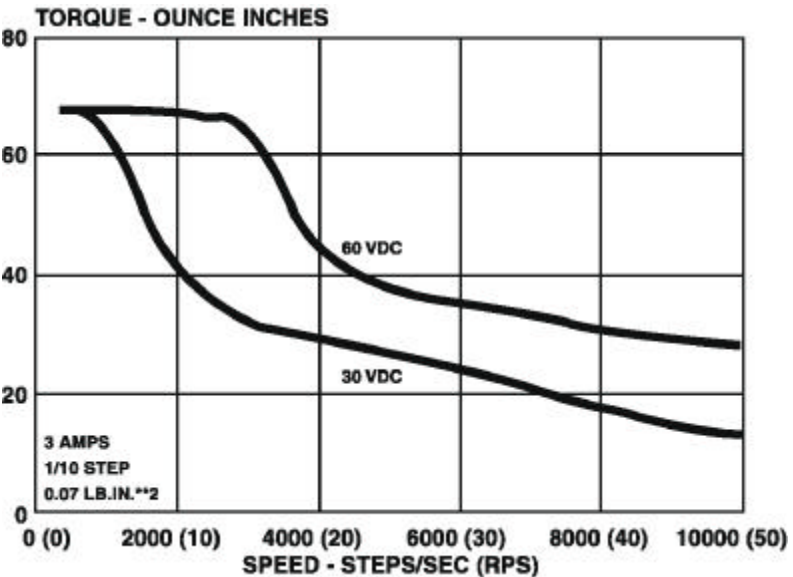

**M061-LE08 MOTOR, 3 AMPERES
SERIES CONNECTION**

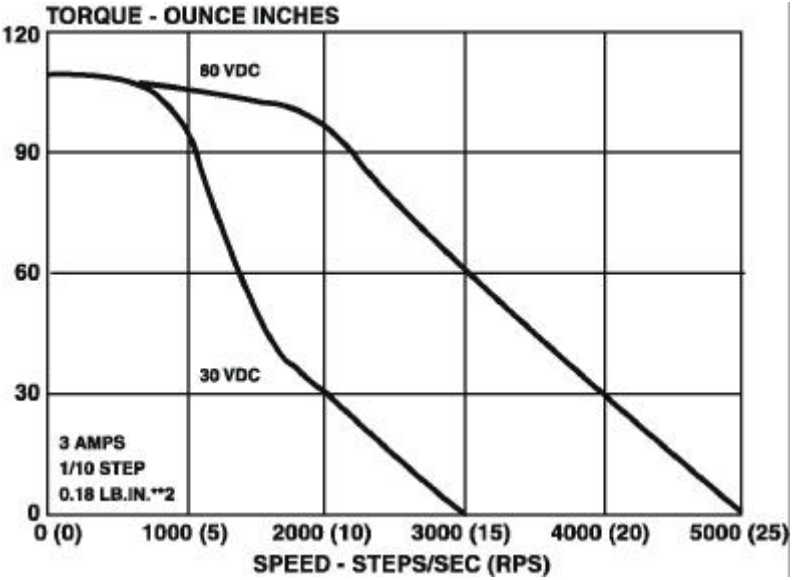

**M062-LE09 MOTOR, 3 AMPERES
SERIES CONNECTION**

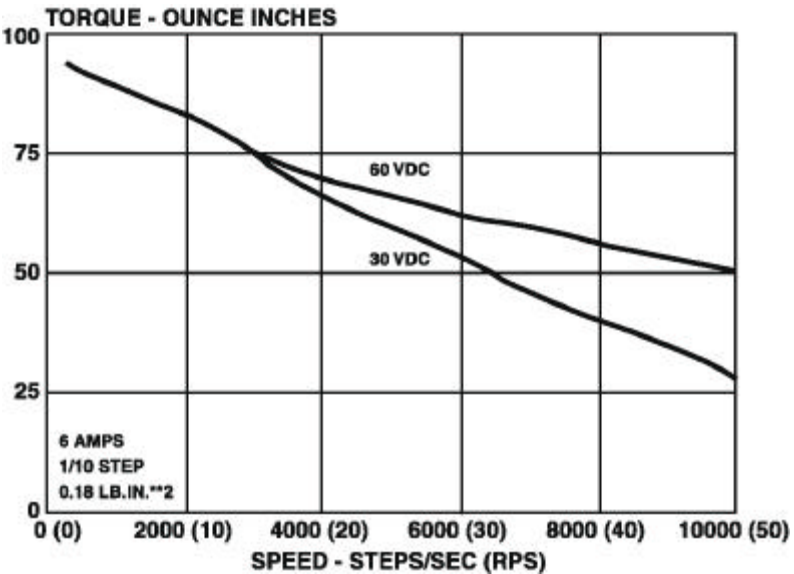

**M062-LE09 MOTOR, 6 AMPERES
PARALLEL CONNECTION**

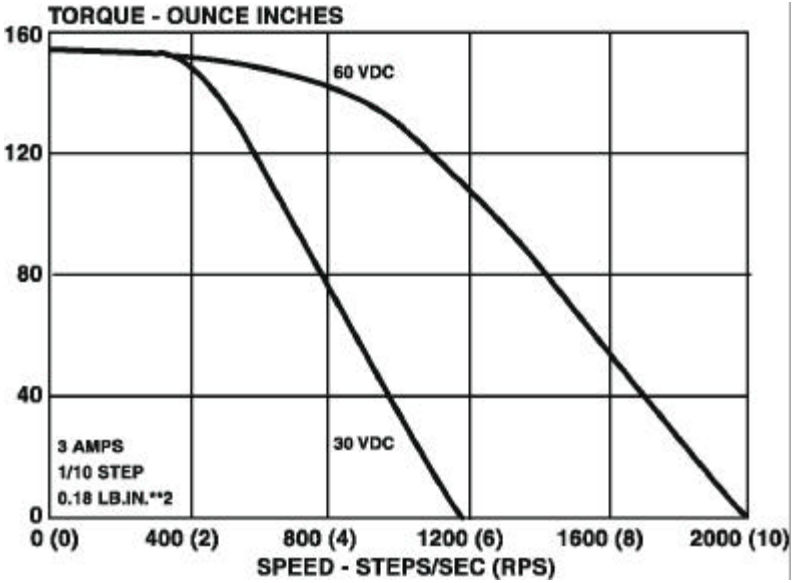

**M063-LE09 MOTOR, 3 AMPERES
SERIES CONNECTION**

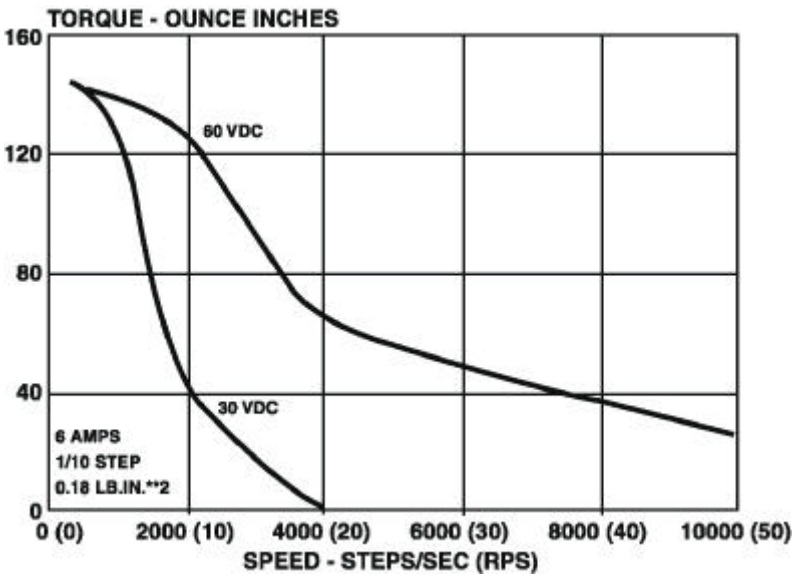

**M063-LE09 MOTOR, 6 AMPERES
PARALLEL CONNECTION**

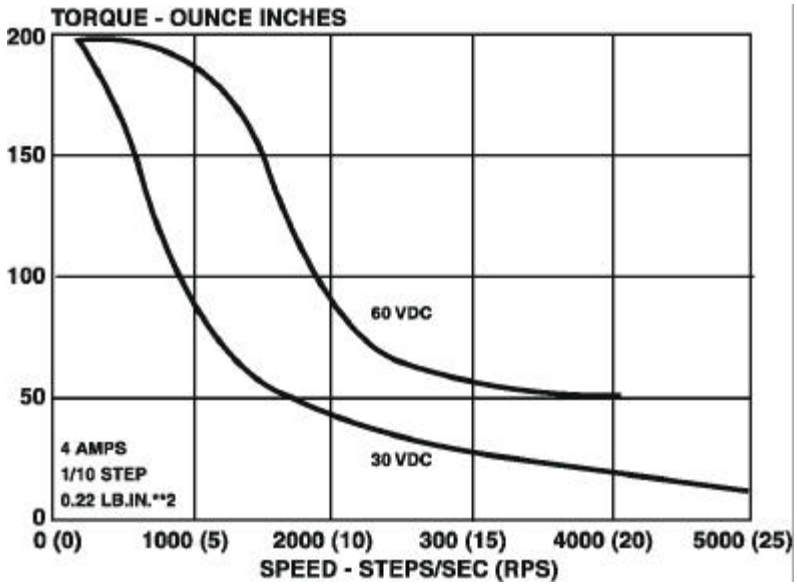

**M091-FD8009 or M091-FD8109 MOTOR, 4 AMPERES
SERIES CONNECTION**

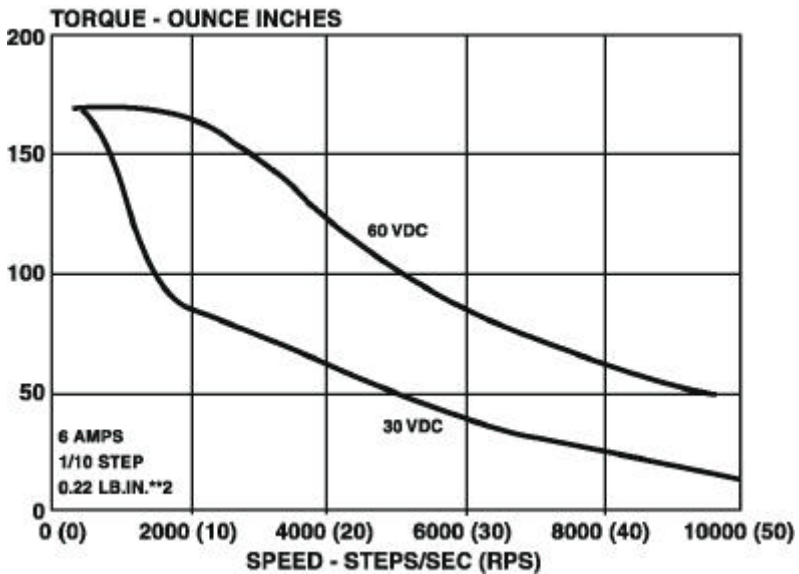

**M091-FD8009 or M091-FD8109 MOTOR, 6 AMPERES
PARALLEL CONNECTION**

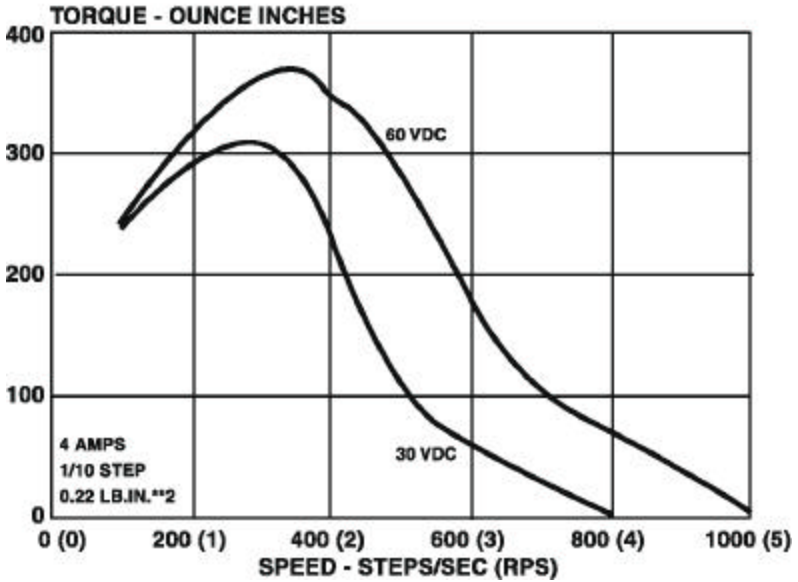

**M092-FD8009 or M092-FD8109 MOTOR, 4 AMPERES
SERIES CONNECTION**

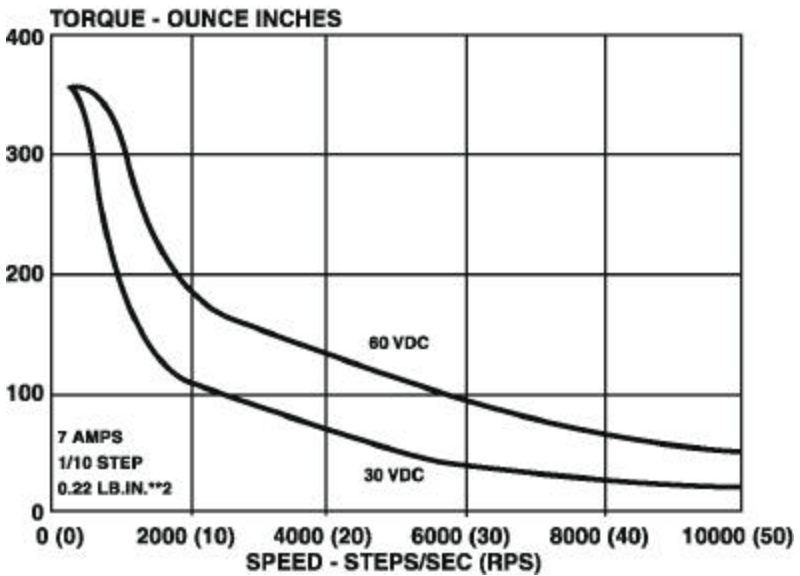

**M092 FD8009 or M092-FD8109 MOTOR, 7 AMPERES
PARALLEL CONNECTION**

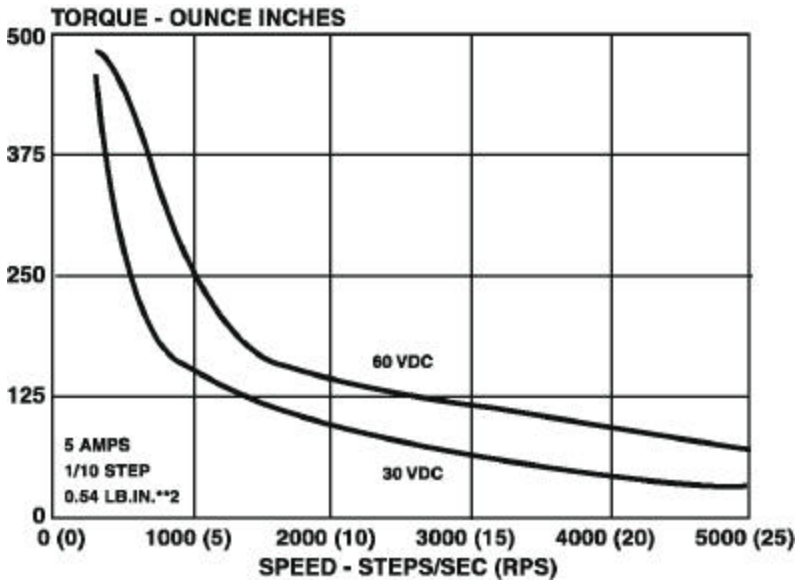

**M093-FD8114 or M093-FD8014 MOTOR, 5 AMPERES
SERIES CONNECTION**

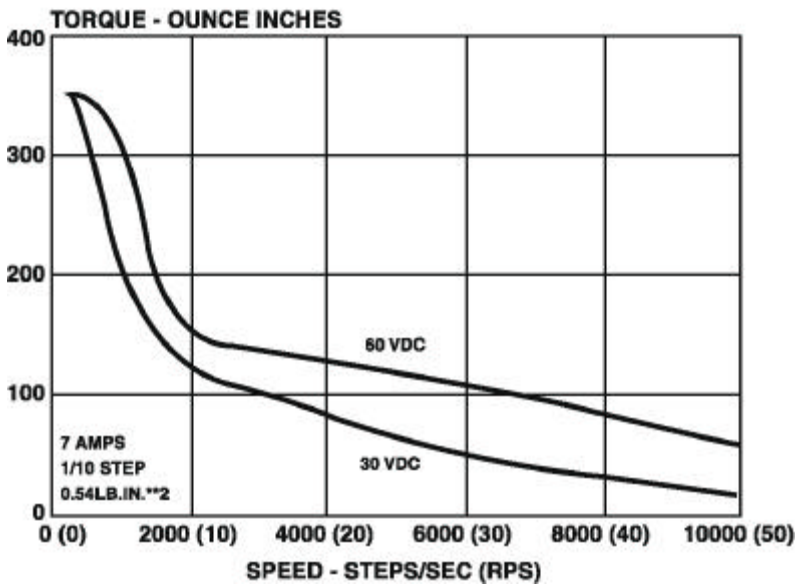

**M093-FD8114 or M093-FD8014 MOTOR, 7 AMPERES
PARALLEL CONNECTION**

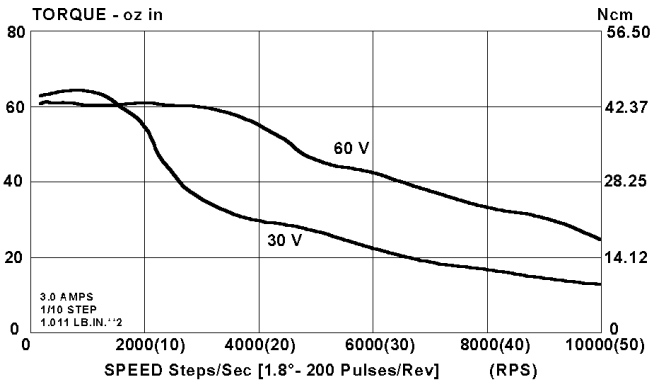

KML060F05 MOTOR, 3.0 Amp

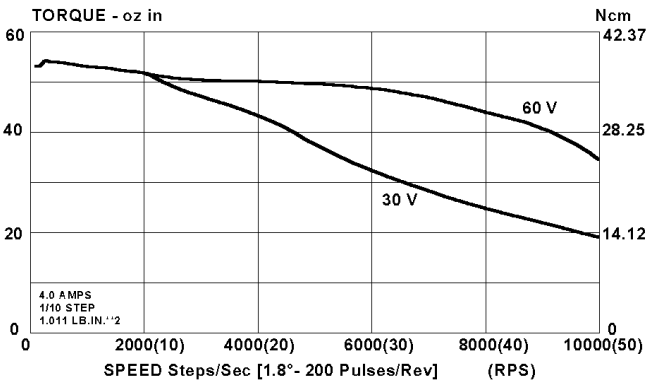

KML060F08 MOTOR, 4.0 Amp

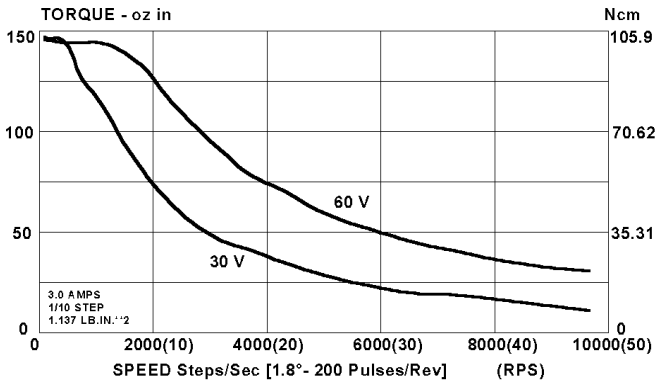

KML061F05 MOTOR, 3.0 Amp

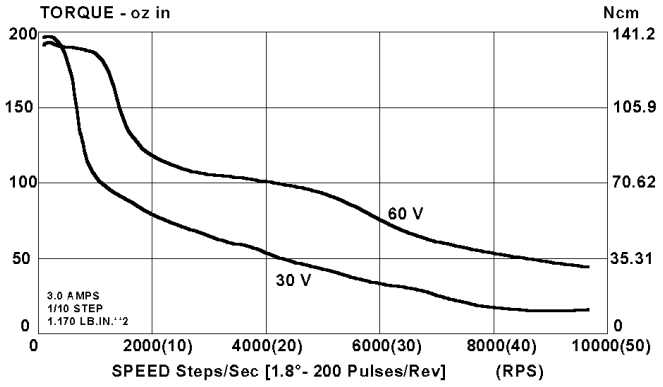

KML062F07 MOTOR, 3.0 Amp

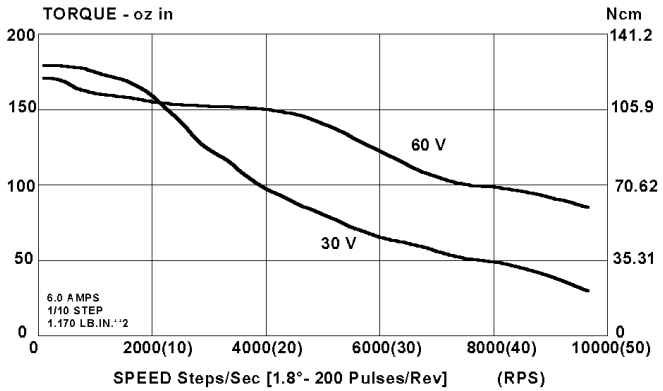

KML062F13 MOTOR, 6.0 Amp

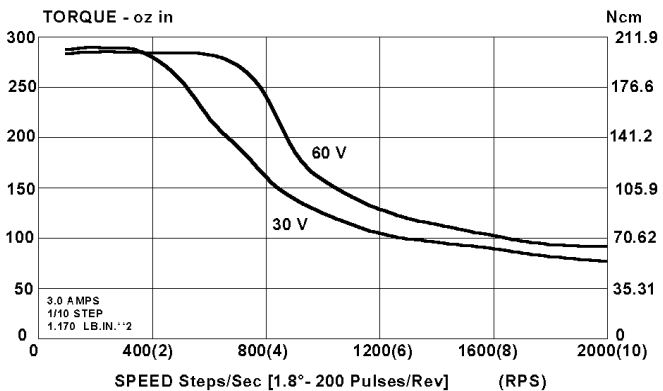

KML063F07 MOTOR, 3.0 Amp

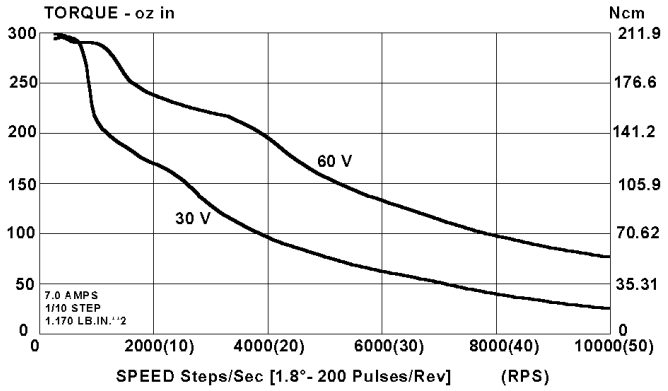

KML063F13 MOTOR, 7.0 Amp

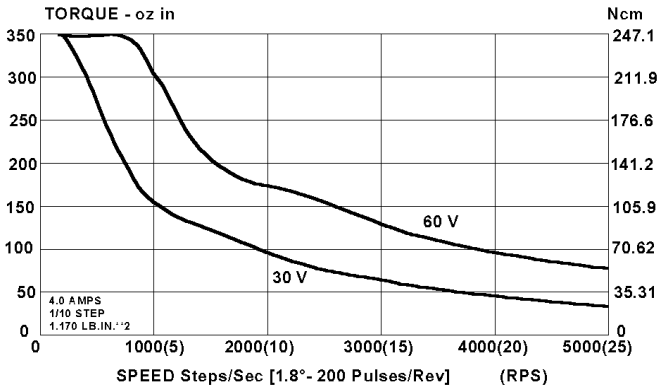

KML091F07 MOTOR, 4.0 Amp

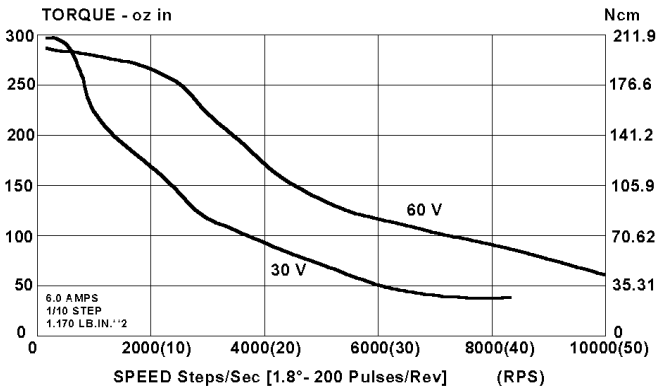

KML091F13 MOTOR, 6.0 Amp

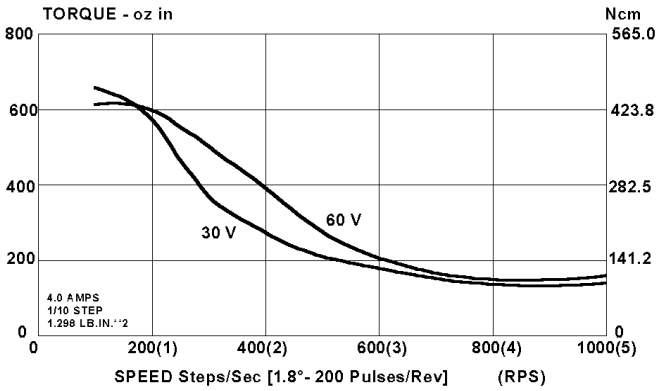

KML092F07 MOTOR, 4.0 Amp

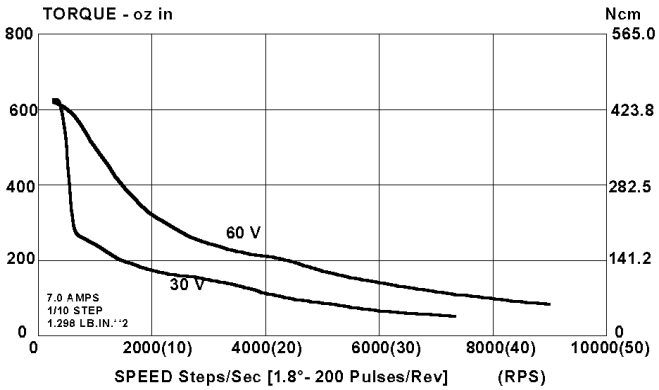

KML092F13 MOTOR, 7.0 Amp

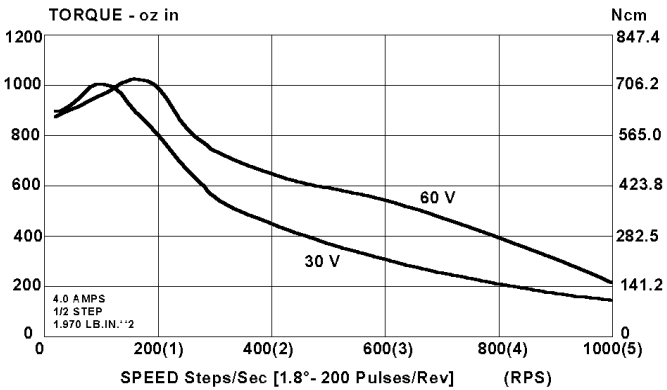

KML093F07 MOTOR, 4.0 Amp

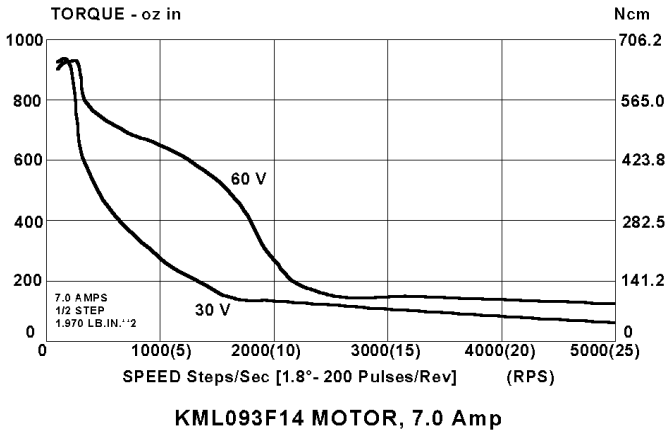

SECTION 6: TROUBLESHOOTING

WARNING:

Motors connected to this drive can develop high torque and large amounts of mechanical energy.

Keep clear of the motor shaft and all parts mechanically linked to the motor shaft.

Turn off all power to the drive before performing work on parts mechanically coupled to the motor.

If installation and operating instructions have been followed carefully, this unit should perform correctly. If the motor fails to step properly, the following checklist will help locate and correct the problem.

In General:

- Check all installation wiring carefully for wiring errors or poor connections.
- Check to see that the proper voltage levels are being supplied to the unit. Be sure that the "POWER" LED lights when power is applied.
- Be sure that the motor is a correct model for use with this unit.

Specifically:

IF MOTOR DIRECTION (CW, CCW) IS REVERSED, Check For:

Reversed connections to the Motor Connector. Reversing the phase A **or** the phase B connections will reverse the direction of motor rotation.

IF THE MOTOR MOTION IS ERRATIC, Check For:

Supply voltage out of tolerance.

Improper motion parameters (low speed, acceleration/deceleration, jog speed, home speed and feed rate). Set parameters on controller supplying pulse input to drive.

Filter capacitor missing or too low in value.

IF TORQUE IS LOW, Check For:

All Windings Off active or Reduced Current active.

Improper supply voltage.

IF "POWER" INDICATOR IS NOT LIT, Check For:

Improper input wiring and voltage levels

Blown supply circuit fuse or tripped input circuit breaker

IF "FAULT" INDICATOR IS LIT, Check For:

Improper motor wiring

Grounded or shorted wiring to the motor or shorted motor

Improper motor type or incorrect Current Select switch setting

Ambient temperature around drive above 50 °C (122 °F)

Heat sink temperature above 70 °C (158 °F)

Restricted airflow around drive

If a malfunction occurs that cannot be corrected by making the preceding checks, contact Superior Electric.

APPENDIX A: TROUBLESHOOTING ELECTRICAL INTERFERENCE PROBLEMS

Electrical interference problems are common with today's computer-based controls, and such problems are often difficult to diagnose and cure. If such a problem occurs with your system, it is recommended that the following checks be made to locate the cause of the problem.

1. Check the quality of the ac line voltage using an oscilloscope and a line monitor, such as the Superior Electric VMS series. If line voltage problems exist, use appropriate line conditioning, such as line filters or isolation transformers.
2. Be certain proper wiring practices are followed for location, grounding, wiring and relay suppression.
3. Double check the grounding connections to be sure they are good electrical connections and are as short and direct as possible.
4. Try operating the drive with all suspected noise sources switched off. If the drive functions properly, switch the noise sources on again, one at a time, and try to isolate which ones are causing the interference problems. When a noise source is located, try rerouting wiring, suppressing relays or other measures to eliminate the problem.

***SAVE THESE
INSTRUCTIONS***

WARRANTY AND LIMITATION OF LIABILITY

Superior Electric (the "Company"), Bristol, Connecticut, warrants to the first end user purchaser (the "purchaser") of equipment manufactured by the Company that such equipment, if new, unused and in original unopened cartons at the time of purchase, will be free from defects in material and workmanship under normal use and service for a period of one year from date of shipment from the Company's factory or a warehouse of the Company in the event that the equipment is purchased from the Company or for a period of one year from the date of shipment from the business establishment of an authorized distributor of the Company in the event that the equipment is purchased from an authorized distributor.

THE COMPANY'S OBLIGATION UNDER THIS WARRANTY SHALL BE STRICTLY AND EXCLUSIVELY LIMITED TO REPAIRING OR REPLACING, AT THE FACTORY OR A SERVICE CENTER OF THE COMPANY, ANY SUCH EQUIPMENT OR PARTS THEREOF WHICH AN AUTHORIZED REPRESENTATIVE OF THE COMPANY FINDS TO BE DEFECTIVE IN MATERIAL OR WORKMANSHIP UNDER NORMAL USE AND SERVICE WITHIN SUCH PERIOD OF ONE YEAR. THE COMPANY RESERVES THE RIGHT TO SATISFY SUCH OBLIGATION IN FULL BY REFUNDING THE FULL PURCHASE PRICE OF ANY SUCH DEFECTIVE EQUIPMENT. This warranty does not apply to any equipment which has been tampered with or altered in any way, which has been improperly installed or which has been subject to misuse, neglect or accident.

THE FOREGOING WARRANTY IS IN LIEU OF ANY OTHER WARRANTIES, EXPRESS OR IMPLIED, INCLUDING, WITHOUT LIMITATION, ANY IMPLIED WARRANTY OF MERCHANTABILITY OR FITNESS FOR A PARTICULAR PURPOSE, and of any other obligations or liabilities on the part of the Company; and no person is authorized to assume for the Company any other liability with respect to equipment manufactured by the Company. The Company shall have no liability with respect to equipment not of its manufacture. **THE COMPANY SHALL HAVE NO LIABILITY WHATSOEVER IN ANY EVENT FOR PAYMENT OF ANY INCIDENTAL OR CONSEQUENTIAL DAMAGES, INCLUDING, WITHOUT LIMITATION, DAMAGES FOR INJURY TO ANY PERSON OR PROPERTY.**

Written authorization to return any equipment or parts thereof must be obtained from the Company. The Company shall not be responsible for any transportation charges.

IF FOR ANY REASON ANY OF THE FOREGOING PROVISIONS SHALL BE INEFFECTIVE, THE COMPANY'S LIABILITY FOR DAMAGES ARISING OUT OF ITS MANUFACTURE OR SALE OF EQUIPMENT, OR USE THEREOF, WHETHER SUCH LIABILITY IS BASED ON WARRANTY, CONTRACT, NEGLIGENCE, STRICT LIABILITY IN TORT OR OTHERWISE, SHALL NOT IN ANY EVENT EXCEED THE FULL PURCHASE PRICE OF SUCH EQUIPMENT.

Any action against the Company based upon any liability or obligation arising hereunder or under any law applicable to the sale of equipment, or the use thereof, must be commenced within one year after the cause of such action arises.

The right to make engineering refinements on all products is reserved. Dimensions and other details are subject to change.



383 Middle Street • Bristol, CT 06010
(860)585-4500 • Fax:(860)589-2136
web site:www.superiorelectric.com



Manufactured Under an ISO9001
Compliant Quality Management System