

INTRODUCTION

This PDF document is a subset of the Sheffield Automation MMC Controls, Block I/O and Cimrex HMI Product Guide, P/N M.1301.6219.

NOTE

Progress is an ongoing commitment at Sheffield Automation. We continually strive to offer the most advanced products in the industry; therefore, information in this document is subject to change without notice. The illustrations and specifications are not binding in detail. Sheffield Automation shall not be liable for any technical or editorial omissions occurring in this document, nor for any consequential or incidental damages resulting from the use of this document.

DO NOT ATTEMPT to use any Sheffield Automation product until the use of such product is completely understood. It is the responsibility of the user to make certain proper operation practices are understood. Sheffield Automation products should be used only by qualified personnel and for the express purpose for which said products were designed.

Should information not covered in this document be required, contact the Customer Service Department, Sheffield Automation, 660 South Military Road, P.O. Box 1658, Fond du Lac, WI 54936-1658. Sheffield Automation can be reached by telephone at 920 921 7100.

Version 2.0

Copyright © 1999 - 2003 Sheffield Automation, LLC

Belden is a trademark of Cooper Industries, Inc.

Cimplicity is a trademark of GE FanucAutomation North America, Inc.

Cimrex is a trademark of Cimrex Electronic AB

Data Highway Plus is a trademark of Allen-Bradley Company

DeviceNet is a trademark of Iris Technologies, Inc.

IEEE is a trademark of the Institute of Electrical and Electronics Engineers

Intellution is a trademark of Intellution, Inc.

Modbus is a trademark of Gould, Inc.

Modicon is a trademark of Modicon Corporation

NEMA is a trademark of the National Energy Manufacturers Association

OPC OLE for Process Control is a trademark of OPC Foundation

Pentium is a trademark of Intel Corporation

RSView is a trademark of Rockwell Software, Inc.

Windows NT, Windows 2000 Windows XP, MS-DOS, QuickBASIC, and Microsoft are trademarks of Microsoft Corporation

Wonderware is a trademark of Wonderware Corporation

PiC900, PiC90, PiCPro, PiCServoPro, PiCMicroTerm, Centurion, and MMC are trademarks of Giddings & Lewis, LLC

Table of Contents: Introduction

Introduction	1
Sheffield Automation - Experts in Motion	3
Multi-Axis Machine and Motion Control Solution Using MMC	5
Distributed Control Solution Using MMC with Ethernet-TCP/IP	6
Multi-Axis Machine and Motion Control Solution Using PiC90/PiC900	7
Multi-Axis Machine and Motion Control Solution Using MMC for PC	8

**MMC CONTROLS, BLOCK I/O AND CIMREX HMI
MOTION SOLUTIONS PRODUCT GUIDE**

Introduction

Sheffield Automation

Sheffield Automation - Experts in Motion

Motion control applications come in all shapes and sizes. Some can be solved with simple positioning servo drives, others with microstepping stepper control, and yet others with multi-axis technologies. In many applications, motion control is not the only requirement. Logic control, process control, network communications, data management, operator interface - most motion control applications involve several, if not all, of these areas. Recognizing this, Sheffield Automation offers excellent motion control solutions that can address your complete machine control requirements as well.

Within the Motion Solutions Product Guide, you will find a wide array of servo amplifiers, servo motors, controls, software, and operator interfaces. Select from these components to create a system configuration for your application. Or, contact Sheffield Automation and let us work with you to identify the optimal solution for your application.



The MMC Smart Drive servo amplifier family ranges from 500 watts to 24kW continuous output power. These amplifiers with integral power supply provide a robust solution to a wide range of applications.

To provide the best match to your application, seven families of Centurion servo motors are available. Low inertia motors for high performance applications, robust medium inertia motors, high-power density packages, as well as NEMA-style motors.



For applications of 1 to 20 axes of servo control, the MMC Machine and Motion Control family provides a powerful, simple, affordable solution. Programmed using PiCPro IEC61131 ladder logic and function blocks to provide total control in a compact package.



Applications of up to 32 axes of servo control are solved by the PiC900 and MMC for PC control families. These rack mount and PC-resident control systems address the most sophisticated applications.



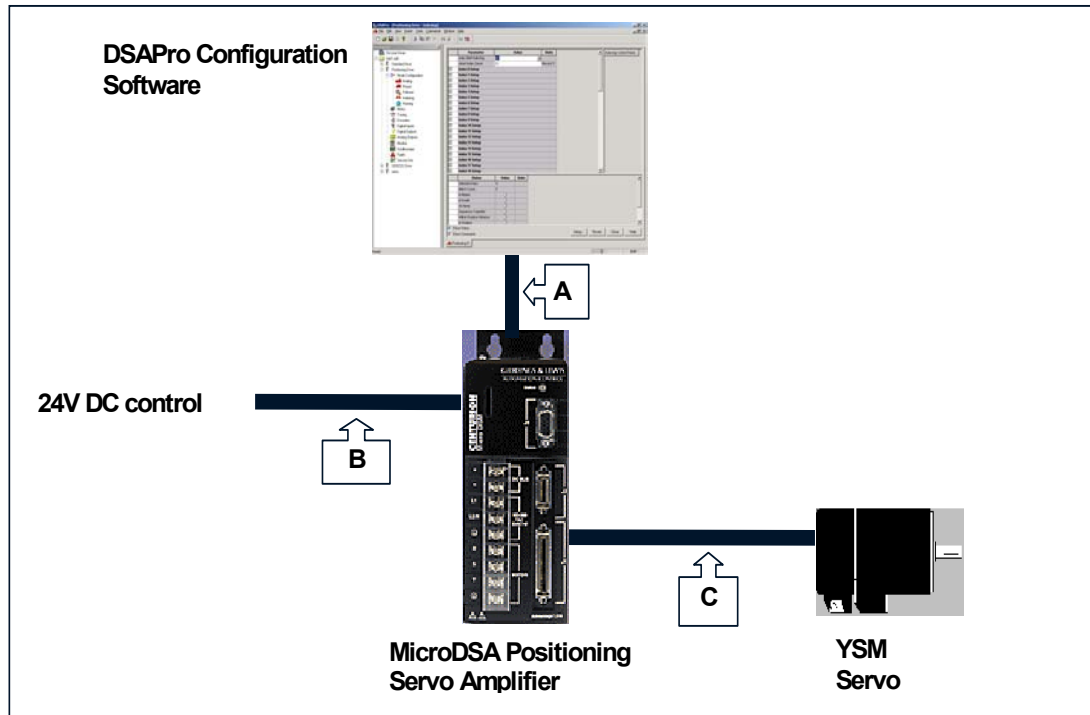

Single Axis Motion Control Solution Using MicroDSA Positioning Drive

- Economical solution for simple motion applications
- MicroDSA Positioning Drive provides built-in position loop control and motion sequencer or DeviceNet interface
- DSAPro configuration (A) software provides point-and-click drive configuration and tuning and definition of up to sixty-four trapezoidal moves in the drive
- Three move types available: Incremental, absolute, and registration
- Expandable to multi-axis applications where motion is not tightly coordinated
- Flexible built-in home routine
- Simple control (B) using 24V DC I/O
- High quality 360 shielded cables (C) with molded connectors for motor power and position feedback.

PiCPro Application Programming Software

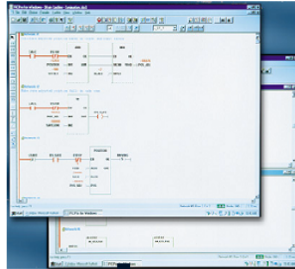

PiCPro Drive Configuration Software

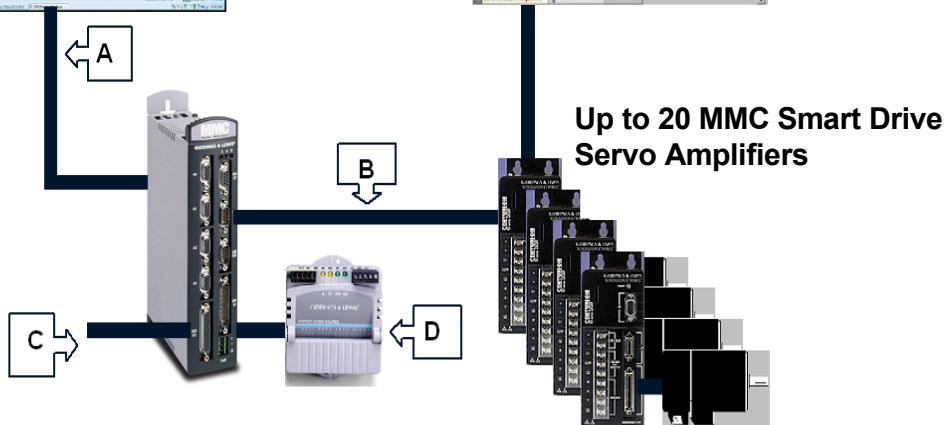
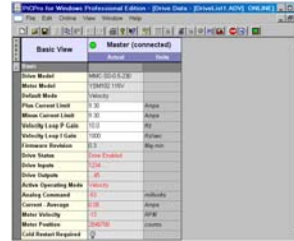

MMC - Machine & Motion Control

Multi-Axis Machine and Motion Control Solution Using MMC

- Economical solution for one to twenty axis analog servo or one to eight axis SERCOS motion control applications
- PiCPro for Windows (A) provides IEC61131 ladder logic for machine control and function block programming for motion control
- Plug-and-Play (B) interface cables to MMC Smart Drive servo drives simplify installation and start up
- Powerful motion instruction set includes position, distance, linear and circular interpolation, cam profiling, and registration control
- Built-in (C) optically isolated 24V DC I/O provided for machine control
- Expansion capability via block I/O (D) built in
- Recipe storage capability allows configurable machine applications
- Built-in programmable limit switch capability simplifies applications

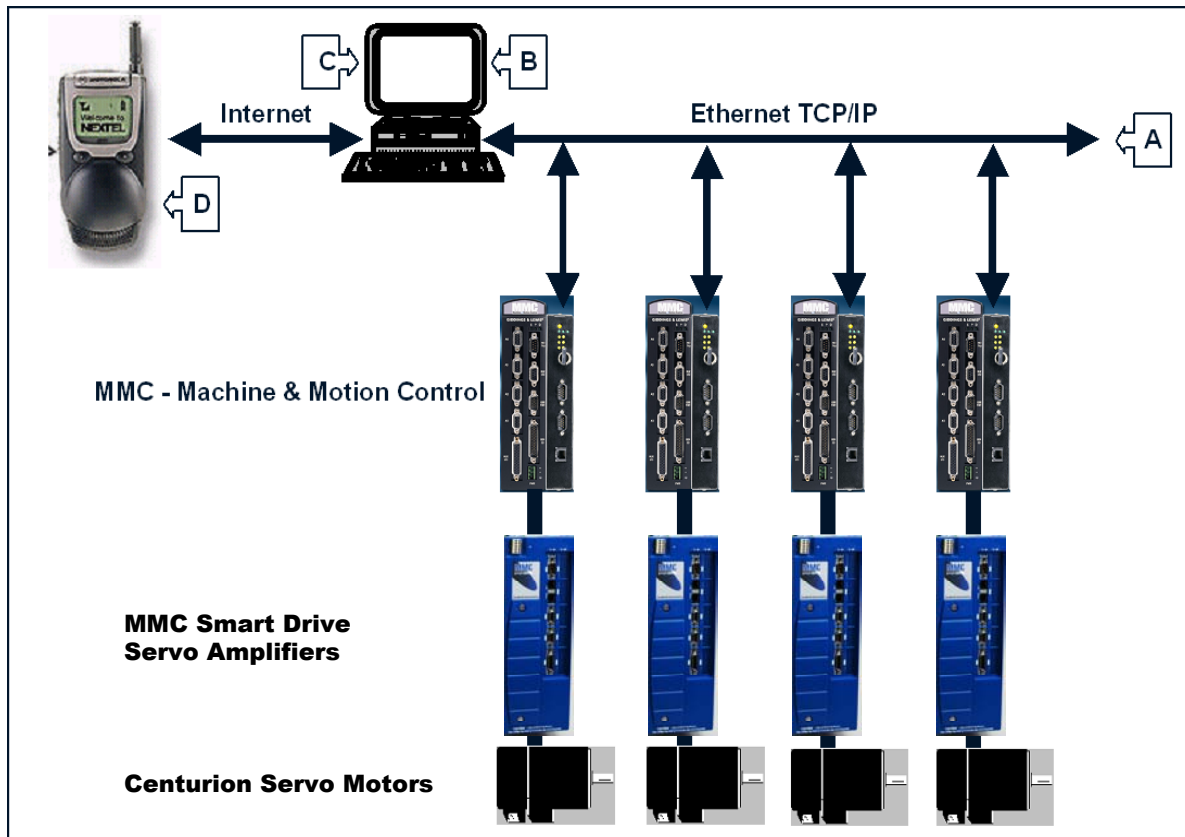

Distributed Control Solution Using MMC with Ethernet-TCP/IP

- Economical, high performance solution for distributed, modular machine architectures
- Ethernet TCP/IP (A) network for data sharing, file transfer, and programming of distributed MMC controls, as well as providing access to plant intranet and internet
- PiCPro for Windows (B) provides IEC61131 ladder logic for machine control and function block programming for motion control. PiCPro operation over Ethernet/ Intranet/Internet simplifies system maintenance
- Giddings & Lewis OPC (OLE for Process Control) Server in Windows XP or Windows NT (C) personal computer provides simple name-based data transfer between any OPC Client (Visual Basic, Excel, Wonderware, Intellution, RSView, Cimplicity, and many more) and MMC controls.
- Internet (D) accessibility allows MMC controls to perform high-level functions such as e-mail transmission using SMTP (Simple Mail Transfer Protocol) providing utility such as pager and digital phone notification of machine fault conditions.

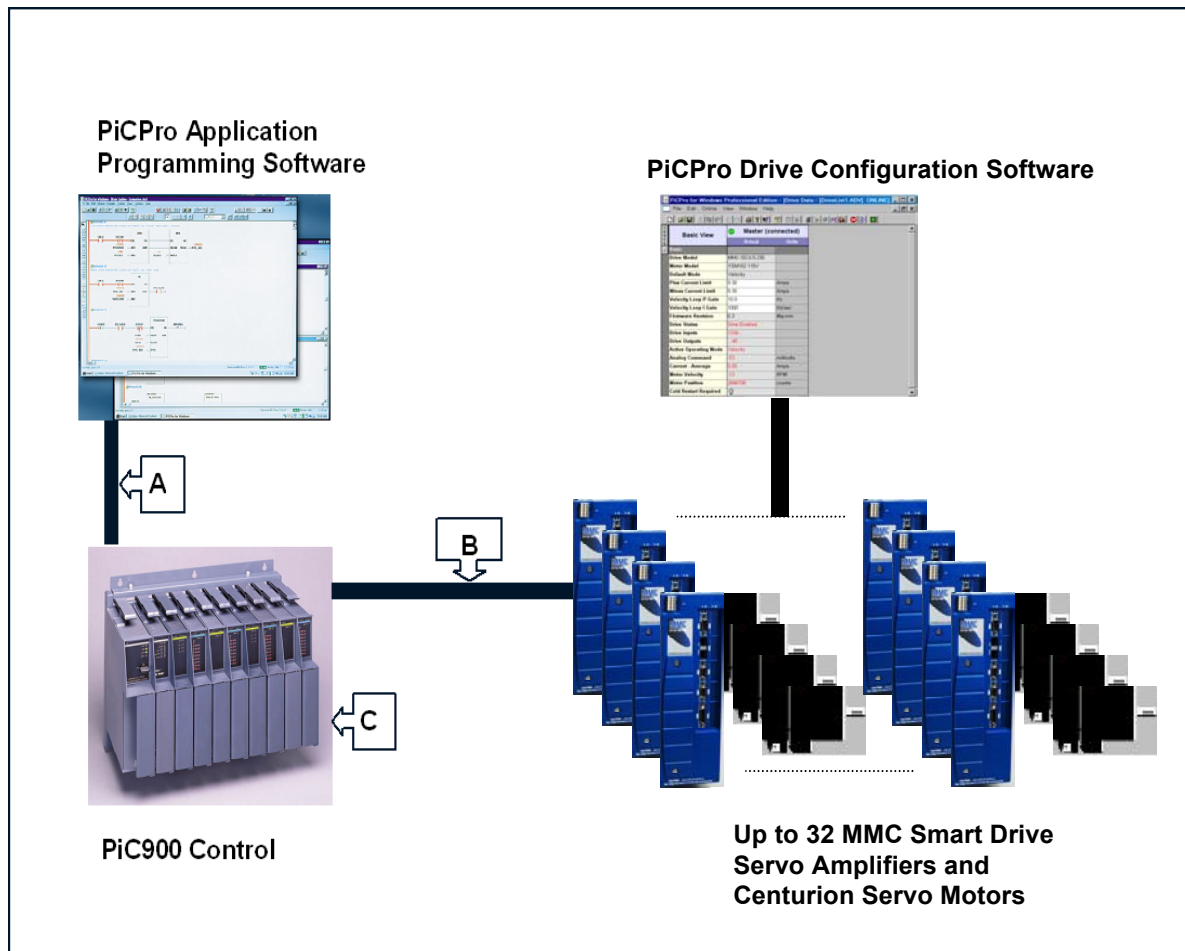

Multi-Axis Machine and Motion Control Solution Using PiC90/PiC900

- Powerful rack-mounted motion control solution capable of up to 32 axes of coordinated servo control
- PiCPro for Windows (A) provides IEC61131 ladder logic for machine control and function block programming for motion control. PiCPro operation over Ethernet/Intranet/Internet simplifies system maintenance
- Servo interface (B) formats include SERCOS digital servo control, analog servo control, or step and direction microstepper control. Position feedback formats include encoder, resolver, and ultrasonic rod
- The PiC family offers a range over 35 types of I/O modules (C), including discrete I/O, analog I/O, process I/O, communications interface, and motion control
- PiC Controls use Ethernet TCP/IP networking for data sharing, file transfer, and programming, as well as providing access to plant intranet and internet

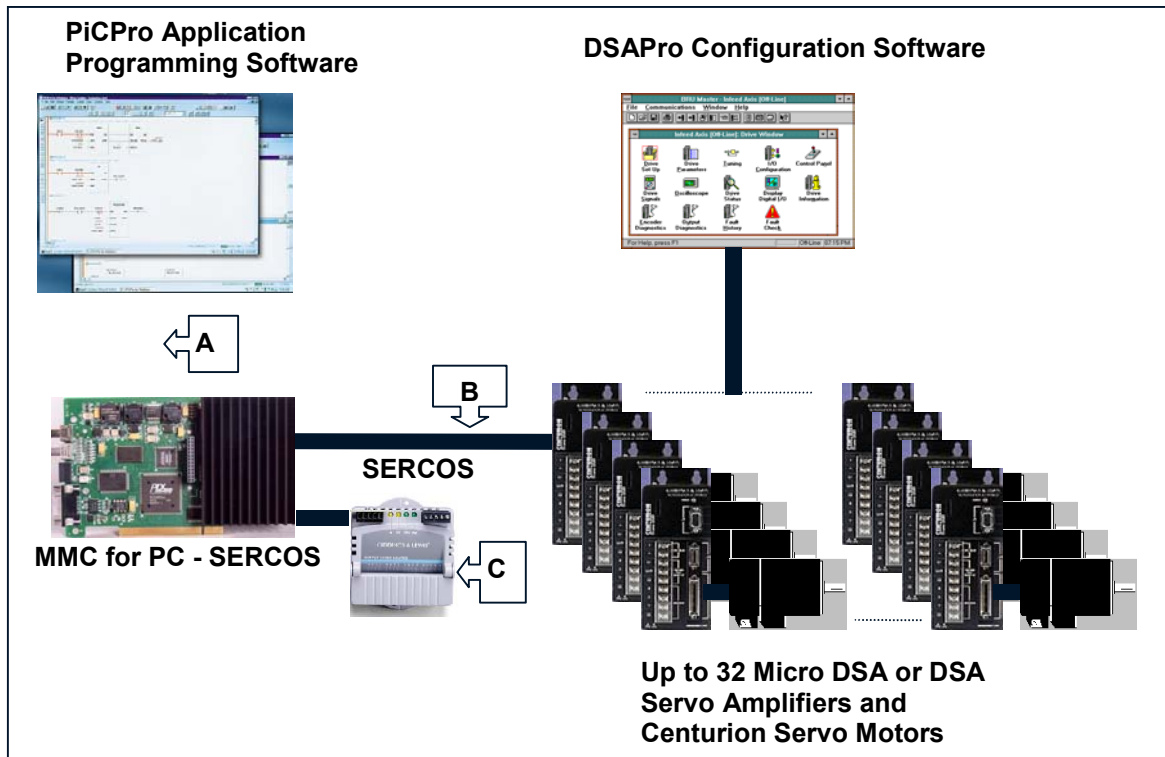

Multi-Axis Machine and Motion Control Solution Using MMC for PC

- Powerful PC resident motion control solution capable of up to 32 axes of analog or SERCOS interfaced coordinated servo control
- PiCPro for Windows (A) provides IEC61131 ladder logic for machine control and function block programming for motion control. PiCPro operation over Ethernet/ Intranet/Internet simplifies system maintenance
- Servo interface (B) formats include SERCOS digital servo control or analog servo control
- Robust distributed expansion I/O (C) provided by Giddings & Lewis Block I/O (up to 1200 I/O points) ranging from DC input and output to analog to motion I/O
- Integrate (A) your automation application with any OPC client (CSCADA, HMI, VB, etc.) using name-based data transfer with the Giddings & Lewis OPC Server