

AKD PDMM®

User Guide



Edition May 2015, Revision E

Valid for Hardware Revision EB

Valid for Firmware Revision 1.13

Part Number 903-200016-00



Keep all manuals as a product component during the life span of the product.
Pass all manuals to future users/owners of the product.

KOLLMORGEN®

Because Motion Matters™

Hardware Revision (HR)

AKD-B/P-NA	AKD-B/P-NB	AKD-M	AKD-T-IC	Firmware/Workbench	KAS IDE	Export Classification	Remarks
A	-	-	-	from 1.3	-	3A225	Start revision, export control
C	-	-	-	from 1.5	-	3A225	STO certified, PROFINET RT released, export control
-	D	DB	DA	from 1.6	from 2.5	3A225	Control board revision 9, AKD PDMM Start revision, AKD BASIC-IC Start revision, export control
D	E	EB	EA	from 1.13	from 2.9	-	Hardware revision for export classification traceability purposes

Trademarks

- AKD PDMM is a registered trademark of Kollmorgen Corporation
- EnDat is a registered trademark of Dr. Johannes Heidenhain GmbH
- EtherCAT is a registered trademark and patented technology, licensed by Beckhoff Automation GmbH
- Ethernet/IP is a registered trademark of ODVA, Inc.
- Ethernet/IP Communication Stack: copyright (c) 2009, Rockwell Automation
- sercos[®] is a registered trademark of sercos[®] international e.V.
- HIPERFACE is a registered trademark of Max Stegmann GmbH
- PROFINET is a registered trademark of PROFIBUS and PROFINET International (PI)
- SIMATIC is a registered trademark of SIEMENS AG
- Windows is a registered trademark of Microsoft Corporation

Current patents

- US Patent 5,162,798 (used in control card R/D)
- US Patent 5,646,496 (used in control card R/D and 1 Vp-p feedback interface)
- US Patent 6,118,241 (used in control card simple dynamic braking)
- US Patent 8,154,228 (Dynamic Braking For Electric Motors)
- US Patent 8,214,063 (Auto-tune of a Control System Based on Frequency Response)

Patents referring to fieldbus functions are listed in the matching fieldbus manual.

Technical changes which improve the performance of the device may be made without prior notice.

Printed in the United States of America

This document is the intellectual property of Kollmorgen. All rights reserved. No part of this work may be reproduced in any form (by photocopying, microfilm or any other method) or stored, processed, copied or distributed by electronic means without the written permission of Kollmorgen.

1 Table of Contents

1	Table of Contents	3
2	Welcome to AKD PDMM User Guide	25
3	AKD PDMM Models	27
4	Software Setup	29
4.1	Install and Start the KAS IDE	29
4.2	KAS IDE Project View	31
4.3	Configuring the Drives and Remote I/O	31
4.4	Where To Go From Here	33
5	Initial Drive Setup	35
5.1	Initial Drive Setup	36
5.2	AKD PDMM Display Codes	36
5.3	AKD PDMM Setup Wizard	37
5.4	Settings	39
5.4.1	Navigation Tree	39
5.4.2	Settings View	39
6	Configuring Drive Power	41
6.1	Power	42
6.1.1	Drive Setup for Power and Bus	42
6.2	Operating Voltage	42
6.3	Direct DC Mains Operation	42
6.4	Regeneration	44
6.4.1	Overview	44
6.4.2	Regen Resistor Options	44
6.4.3	Calculating Motor Peak Energy and Regen Resistor Size	45
6.4.4	Selecting a Compatible Regen Resistor	47
6.4.5	Configuring Regen Parameter Values	49
7	Configuring Motor Settings	51
7.1	Motor	52
7.1.1	Overview	52
7.1.2	Motor Setup	52
7.1.3	Using the Motor View	52
7.1.4	Selecting a Motor	53
7.1.5	Configuring Custom Motors	54
7.1.5.1	Validating Motor Parameters	54
7.1.6	Motor Derating	55
7.1.7	Motor Temperature	56
7.2	Feedback 1	56
7.2.1	Overview	57
7.2.2	Using Feedback Options	57
7.2.2.1	Auto	57
7.2.2.2	None	58
7.2.2.3	Incremental Encoder	58
7.2.2.4	Sine Encoder	58
7.2.2.5	Endat 2.1, Endat 2.2	58

7.2.2.6 BiSS Analog	58
7.2.2.7 Hiperface, Hiperface DSL	58
7.2.2.8 Resolver	58
7.2.2.9 SFD, SFD3	58
7.2.2.10 Tamagawa	58
7.2.2.11 Halls Only	58
7.2.3 Wake and Shake Overview	58
7.3 Extended Multiturn	59
7.4 Non-Plug and Play Feedback Devices	60
7.4.1 Parameters	60
7.4.2 Calculations	60
Current Loop	60
Velocity Loop	60
Slider Tuning	60
Input - Motor Data	61
Constants	61
Output - Control Loop Gains	61
7.5 Foldback	61
7.5.1 Drive Foldback	61
7.5.2 Setting up motor foldback	61
7.5.3 Setting Fault and Warning Levels	62
7.5.4 Motor Peak Current Time	62
7.5.5 Motor Foldback Ramp	63
7.5.6 Motor Recovery	63
7.5.7 Overall Foldback	64
7.6 Brake	64
7.7 Using Position Capture	65
7.7.1 Overview	65
7.7.2 Configuring Position Capture	65
Setting the Capture Source (CAP0.FBSOURCE, CAP1.FBSOURCE (pg 1))	66
Setting the Trigger Source (CAP0.TRIGGER, CAP1.TRIGGER (pg 1))	66
Setting the Capture Mode (CAP0.MODE, CAP1.MODE)	66
Arming and Retrieving the Capture Value (CAP0.T, CAP1.T)	66
Setting the Capture Edge (CAP0.EDGE, CAP1.EDGE)	66
Setting the Pre-Condition Event: (CAP0.EVENT, CAP1.EVENT)	67
Setting up a Pre-Condition for complex capture	67
7.7.3 Kollmorgen Test Reports	67
8 Using AKD PDMM in a Vertical Axis	69
9 Configuring with Linear Motors	71
9.1 Connecting a DDL Motor to an AKD PDMM Drive	71
10 Configuring General Drive Settings	74
10.1 Limits	75
10.1.1 Limits	75
10.2 Compare Engines	76

10.2.1 Configuring Position Compare	76
10.2.1.1 Order of Configuration	76
10.2.1.2 Setting Compare Sources (CMPx.SOURCE (→ p. 1))	77
10.2.2 Setting Compare Setpoints (CMPx.SETPOINT (→ p. 1))	77
10.3 Enable/Disable	78
10.3.1 Enable Modes	78
Hardware Enable Mode	78
Software Enable Default	78
10.3.2 Disable Modes	79
10.3.3 Drive Status	79
10.3.4 Controlled Stop	80
10.3.5 More/Less Button	80
10.4 Controlled Stop	81
10.5 Dynamic Braking	83
10.5.1 Drive Regeneration	83
AKD-M00306 to AKD-M00606	83
AKD-M01206 to AKD-Mzzz07	83
10.6 Emergency Stop	84
10.6.1 Stop / Emergency Stop / Emergency Off	84
10.6.1.1 Stop	84
10.6.1.2 Emergency Stop	86
10.6.1.3 Emergency Off	86
10.7 Under Voltage Fault Behavior	86
10.7.1 Current Loop Gain Scheduling	86
10.7.1.1 Using the Gain Scheduling View in EWW	87
Using the Terminal View for Gains Scheduling	88
11 Creating Motion	90
11.1 Service Motion	91
11.2 Motion Profile Table	92
11.2.1 Grid	93
11.2.2 Graphical Representation	93
11.2.3 Control Buttons	94
11.2.3.1 Import Table Data	95
11.2.3.2 Importing data from Preset Table option	95
11.2.3.3 Importing data from an external CSV file	96
11.2.4 Creating Motion Profile Tables	96
11.2.4.1 Example of a motion profile table	96
11.2.4.2 Motion Profile Table Restrictions	97
11.2.4.3 Different methods of motion table motion tasking	98
General motion profile table explanations	98
11.2.4.4 Use of IL.KACFF with Motion Tables	99
11.2.4.5 Profile Table Interpolation Motion Task	99
11.2.4.6 OneToOne interpolation motion task	99
11.2.4.7 Setting up a motion profile motion task	100
11.2.4.8 Drive reaction on impossible motion tasks	100

OneToOne interpolation limitations	100
11.2.4.9 Profile Table interpolation limitations	101
Starting from velocity 0 without change-on-the-fly to a following motion task	101
During a change on the fly condition	101
Movement to the same direction	101
Movement in different directions	102
12 Tuning Your System	104
12.1 Introduction	105
12.2 Slider Tuning	105
12.2.1 Load Inertia	105
12.2.2 Gentle, Medium, and Stiff	106
12.2.3 The Slider	106
12.3 Using the Performance Servo Tuner	106
12.3.0.1 Overview	106
12.3.0.2 Using the PST	106
Saving and Emailing Bode Plots	108
Importing a Frequency Response	109
12.3.0.3 Measurement Options	109
Using Manual Excitation Levels	109
12.3.0.4 Taking a Bode Measurement without the PST	110
12.3.1 Using the Performance Servo Tuner: Advanced	110
12.3.1.1 Typical Cases for Advanced PST Use	110
12.3.1.2 PST Options	115
12.3.1.3 Measurement Options	116
12.3.1.4 Plot Options	123
12.3.1.5 Resizing Bode Plots	125
12.4 Tuning Guide	135
12.4.1 Overview	135
12.4.2 Determining Tuning Criteria	136
12.4.3 Before You Tune	136
12.4.4 Closed Loop Tuning Methods	136
12.4.4.1 Tuning the Velocity Loop	137
12.4.4.2 Tuning the Position Loop	139
12.4.5 Torque Feedforward Tuning Methods	140
12.4.5.1 Shape Based Feedforward Tuning	140
12.4.6 Using Anti-Resonance Filters	140
12.4.6.1 Types of Anti-Resonance Filters	141
12.4.6.2 Biquad Calculations	148
12.4.6.3 Common Uses Of Anti-Resonance Filters	152
13 Scope	153
13.1 Overview	153
13.2 Using the Scope	153
13.2.1 Scope Channels Tab	153
13.2.1.1 Source Column	153
13.2.1.2 Color Column	154

13.2.1.3	Hide Column	154
13.2.1.4	Y-Axis Column	154
13.2.1.5	Filter and Filter Frequency Column	154
13.2.2	Measure Tab	154
13.2.2.1	AC RMS and True RMS	154
13.2.3	Scope Time-base and Trigger Tab	154
13.2.3.1	Scope Time-base and Trigger, More View	156
13.2.3.2	Trigger Type	157
13.2.3.3	Trigger Position	157
13.2.3.4	Trigger Value	158
13.2.3.5	Effects of Recorder Gap	159
13.2.3.6	Trigger Slope	160
13.3	Scope Settings	161
13.3.1	Load a setting (preset) to Scope screen	161
13.3.2	Create a new preset	161
13.3.3	Save or delete preset	162
13.3.4	Import preset	162
13.3.5	Export preset	162
13.3.6	Scope axis scaling and zooming	163
13.3.7	Manual range per axis	164
13.3.8	Unit display on Y axis	164
14	Using Parameters and the Terminal Screen	165
14.1	Terminal	166
14.1.1	Overview	166
14.1.2	Using the Terminal	166
14.1.3	Macros	167
	Creating a Macro from Terminal commands	167
	Macro Editor	169
14.2	Parameter List	170
14.3	Parameter Load/Save	172
14.3.1	Loading an Incompatible File	172
15	Faults and Warnings	173
15.1	Fault and Warning Messages	174
15.2	Additional error and alarm messages AKD PDMM	192
15.2.1	Alarms	192
15.2.2	Errors	193
15.3	Clearing Faults	194
15.4	Parameter and Command Error Messages	194
15.5	Unknown Fault	198
15.5.1	Remedies	198
16	Troubleshooting the AKD PDMM	199
17	Connection Diagrams	201
17.1	Connection diagram	202
17.2	Connection diagram	203
17.3	Connection diagram	205
17.4	24 V auxiliary supply (X1)	206
17.4.1	AKD-M003 to 024, connector X1	206

17.4.2 AKD-M048, connector X1	206
17.5 Motor Power Connection (X2)	206
17.5.1 AKD-M003 to 024, power connector X2	208
17.5.2 AKD-M048, power connector X2	208
17.6 External regen resistor (X3)	208
17.6.1 AKD-M003 to 024, regen connector X3	208
17.6.2 AKD-M048, regen connector X3	211
17.7 DC Bus link (X3, X14)	211
17.7.1 DC Bus topology with Y connectors (24 A max.)	212
17.7.2 DC Bus topology with busbar	213
17.8 Mains supply connection (X3, X4)	214
17.8.1 Three phase connection (all AKD PDMM types)	215
17.8.2 Single/Dual phase connection (AKD-M00306 to AKD-M01206 only)	215
17.9 I/O Connection	216
17.9.1 Overview	216
17.9.1.1 I/O connectors X7 and X8 (all AKD PDMM variants)	216
17.9.1.2 I/O connectors X35 and X36 (AKD PDMM only)	217
17.10 Analog Output (X8)	218
17.11 Analog Input (X8)	219
17.12 Command encoder signal connection	220
17.12.1 Incremental encoder input 5 V (X9)	220
17.12.2 Incremental encoder input 24 V (X7)	221
17.12.3 Encoder with EnDat 2.2 input 5 V (X9)	222
17.13 Pulse / Direction signal connection	222
17.13.1 Pulse / Direction input 5 V (X9)	223
17.13.2 Pulse / Direction Input 5 V to 24 V (X7)	223
17.14 CW / CCW signal connection	223
17.14.1 CW / CCW input 5 V (X9)	223
17.14.2 CW / CCW input 24 V (X7)	224
17.15 Feedback connector (X10)	224
17.16 Feedback connector (X9)	225
17.17 Feedback connector (X7)	225
18 AKD PDMM Firmware	227
18.1 Check AKD PDMM Drive Firmware	227
18.2 Download AKD PDMM Drive Firmware	227
18.3 AKD PDMM Firmware Update	227
19 Parameter and Command Reference Guide	229
19.1 About the Parameter and Command Reference Guide	242
19.1.1 Parameter and Command Naming Conventions	243
19.1.2 Summary of Parameters and Commands	244
19.2 AOUT Parameters	260
19.2.1 AOUT.CUTOFF	261
19.2.2 AOUT.DEBUGADDR	262
19.2.3 AOUT.DEBUGDATATYPE	263
19.2.4 AOUT.DEBUGSCALE	264
19.2.5 AOUT.ISCALE	265
19.2.6 AOUT.MODE	266

19.2.7 AOUT.OFFSET	267
19.2.8 AOUT.PSCALE	268
19.2.9 AOUT.VALUE	269
19.2.10 AOUT.VALUEU	270
19.2.11 AOUT.VSCALE	271
19.3 AOUT2 Parameters	272
19.3.1 AOUT2.CUTOFF	273
19.3.2 AOUT2.MODE	274
19.3.3 AOUT2.OFFSET	275
19.3.4 AOUT2.VALUE	276
19.3.5 AOUT2.VALUEU	277
19.4 BODE Parameters	278
19.4.1 BODE.EXCITEGAP	279
19.4.2 BODE.FREQ	280
19.4.3 BODE.IAMP	281
19.4.4 BODE.IFLIMIT	282
19.4.5 BODE.IFTHRESH	283
19.4.6 BODE.INJECTPOINT	284
19.4.7 BODE.MODE	285
19.4.8 BODE.MODETIMER	288
19.4.9 BODE.PRBDEPTH	290
19.4.10 BODE.VAMP	291
19.4.11 BODE.VFLIMIT	292
19.4.12 BODE.VFTHRESH	293
19.5 CMP Parameters	294
19.5.1 CMPx.ADVANCE	295
19.5.2 CMPx.ARM	296
19.5.3 CMPx.MODBOUND1	297
19.5.4 CMPx.MODBOUND2	298
19.5.5 CMPx.MODE	299
19.5.6 CMPx.MODEN	301
19.5.7 CMPx.MODVALUE	302
19.5.8 CMPx.OUTMASK	303
19.5.9 CMPx.SETPOINT	304
19.5.10 CMPx.SOURCE	306
19.5.11 CMPx.SOURCEVALUE	307
19.5.12 CMPx.STATE	308
19.5.13 CMPx.WIDTH	309
19.5.14 CMPx.WIDTHTYPE	311
19.6 CS Parameters	313
19.6.1 CS.DEC	314
19.6.2 CS.STATE	315
19.6.3 CS.TO	316
19.6.4 CS.VTHRESH	317
19.7 DIN Parameters	318
19.7.1 DIN.HCMD1 TO DIN.HCMD4	319
19.7.2 DIN.LCMD1 to DIN.LCMD4	320

19.7.3 DIN.ROTARY	321
19.7.4 DIN.STATES	322
19.7.5 DIN1.FILTER TO DIN7.FILTER	323
19.7.6 DIN1.INV to DIN7.INV	324
19.7.7 DIN1.MODE TO DIN7.MODE	325
19.7.8 DIN1.PARAM TO DIN7.PARAM	327
19.7.9 DIN1.STATE TO DIN7.STATE	329
19.7.10 DIN9.STATE to DIN11.STATE	330
19.7.11 DIN21.FILTER to DIN32.FILTER	331
19.7.12 DIN21.STATE to DIN32.STATE	332
19.8 DIO Parameters	333
19.8.1 DIO9.INV to DIO11.INV	334
19.8.2 DIO9.DIR to DIO11.DIR	335
19.9 DOUT Parameters	336
19.9.1 DOUT.CTRL	337
19.9.2 DOUT.RELAYMODE	338
19.9.3 DOUT.STATES	339
19.9.4 DOUT1.MODE and DOUT2.MODE	340
19.9.5 DOUT1.PARAM AND DOUT2.PARAM	341
19.9.6 DOUT1.STATE AND DOUT2.STATE	343
19.9.7 DOUT1.STATEU AND DOUT2.STATEU	344
19.9.8 DOUT9.MODE to DOUT11.MODE	345
19.9.9 DOUT9.PARAM to DOUT11.MODE	346
19.9.10 DOUT9.STATE to DOUT11.STATE	347
19.9.11 DOUT9.STATEU to DOUT11.STATEU	348
19.9.12 DOUT21.STATE to DOUT32.STATE	349
19.9.13 DOUT21.STATEU to DOUT32.STATEU	350
19.10 DRV Parameters	351
19.10.1 DRV.ACC	354
19.10.2 DRV.ACTIVE	356
19.10.3 DRV.BLINKDISPLAY	357
19.10.4 DRV.BOOTTIME	358
19.10.5 DRV.CLRFAULTHIST	359
19.10.6 DRV.CLRFAULTS	360
19.10.7 DRV.CMDDELAY	361
19.10.8 DRV.CMDSOURCE	362
19.10.9 DRV.CRASHDUMP	363
19.10.10 DRV.CUSTOMIDENTIFIER	364
19.10.11 DRV.DBILIMIT	365
19.10.12 DRV.DEC	366
19.10.13 DRV.DIFVAR	368
19.10.14 DRV.DIR	369
19.10.15 DRV.DIS	371
19.10.16 DRV.DISMODE	372
19.10.17 DRV.DISSOURCES	373
19.10.18 DRV.DISSOURCESMASK	374
19.10.19 DRV.DISTO	375

19.10.20 DRV.DOWNLOADALLOWED	376
19.10.21 DRV.EMUECHECKSPEED	377
19.10.22 DRV.EMUEDIR	378
19.10.23 DRV.EMUEMODE	379
19.10.24 DRV.EMUEMTURN	381
19.10.25 DRV.EMUEPULSEWIDTH	382
19.10.26 DRV.EMUERES	383
19.10.27 DRV.EMUEZOFFSET	384
19.10.28 DRV.EN	385
19.10.29 DRV.ENDEFAULT	386
19.10.30 DRV.ERRORLIST	387
19.10.31 DRV.FAULTDISPLAYMODE	388
19.10.32 DRV.FAULTHIST	389
19.10.33 DRV.FAULT1 to DRV.FAULT10	390
19.10.34 DRV.FAULTS	391
19.10.35 DRV.HANDWHEELSRC	392
19.10.36 DRV.HELP	393
19.10.37 DRV.HELPALL	394
19.10.38 DRV.HWENABLE	395
19.10.39 DRV.HWENDELAY	396
19.10.40 DRV.HWENMODE	397
19.10.41 DRV.ICONT	398
19.10.42 DRV.INFO	399
19.10.43 DRV.IPEAK	401
19.10.44 DRV.IZERO	402
19.10.45 DRV.LIST	403
19.10.46 DRV.LOGICVOLTS	404
19.10.47 DRV.MEMADDR	405
19.10.48 DRV.MEMDATA	406
19.10.49 DRV.MOTIONDISSOURCES	407
19.10.50 DRV.NAME	408
19.10.51 DRV.NVCHECK	409
19.10.52 DRV.NVLIST	410
19.10.53 DRV.NVLOAD	411
19.10.54 DRV.NVSAVE	412
19.10.55 DRV.ONTIME	413
19.10.56 DRV.OPMODE	414
19.10.57 DRV.READFORMAT	415
19.10.58 DRV.REBOOT	416
19.10.59 DRV.RSTVAR	417
19.10.60 DRV.RUNTIME	418
19.10.61 DRV.SETUPREQBITS	419
19.10.62 DRV.SETUPREQLIST	421
19.10.63 DRV.STOP	422
19.10.64 DRV.TEMPERATURES	423
19.10.65 DRV.TYPE	424
19.10.66 DRV.VER	425

19.10.67 DRV.VERIMAGE	426
19.10.68 DRV.WARNING1 to DRV.WARNING3	427
19.10.69 DRV.WARNINGS	428
19.10.70 DRV.ZERO	429
19.11 FAULT Parameters	430
19.11.1 FAULTx.ACTION	431
19.11.2 FAULT176.ACTION, FAULT178.ACTION	432
19.11.3 FAULT570.ACTION	433
19.12 FB1 Parameters	434
19.12.1 FB1.BISSBITS	436
19.12.2 FB1.CALTHRESH	437
19.12.3 FB1.DIAG	438
19.12.4 FB1.ENCRES	439
19.12.5 FB1.EXTENDEDMULTITURN	440
19.12.6 FB1.FAULTS	441
19.12.7 FB1.HALLSTATE	443
19.12.8 FB1.HALLSTATEU	445
19.12.9 FB1.HALLSTATEV	446
19.12.10 FB1.HALLSTATEW	447
19.12.11 FB1.IDENTIFIED	448
19.12.12 FB1.INITPSAVED	449
19.12.13 FB1.INITPSTATUS	450
19.12.14 FB1.INITPWINDOW	451
19.12.15 FB1.INITSIGNED	452
19.12.16 FB1.LASTIDENTIFIED	453
19.12.17 FB1.MECHPOS	454
19.12.18 FB1.MEMVER	455
19.12.19 FB1.MOTORPHASE	456
19.12.20 FB1.MOTORPOLES	457
19.12.21 FB1.OFFSET	458
19.12.22 FB1.ORIGIN	459
19.12.23 FB1.P	461
19.12.24 FB1.PDIR	462
19.12.25 FB1.PFIND	463
19.12.26 FB1.PFINDCMDU	464
19.12.27 FB1.PIN	465
19.12.28 FB1.POFFSET	466
19.12.29 FB1.POLES	467
19.12.30 FB1.POUT	468
19.12.31 FB1.PSCALE	469
19.12.32 FB1.PUNIT	470
19.12.33 FB1.RESKTR	471
19.12.34 FB1.RESREFPHASE	472
19.12.35 FB1.SELECT	473
19.12.36 FB1.TRACKINGCAL	475
19.12.37 u	476
19.12.38 FB1.USERDWORD0 to FB1.USERDWORD1	478

19.12.39 FB1.USERWORD0 to FB1.USERWORD3	480
19.13 FB3 Parameters	482
19.13.1 FB3.DIR	483
19.13.2 FB3.ENCREC	484
19.13.3 FB3.MODE	485
19.13.4 FB3.MOTORPHASE	486
19.13.5 FB3.MOTORPOLES	487
19.13.6 FB3.P	488
19.13.7 FB3.PDIR	489
19.13.8 FB3.PIN	490
19.13.9 FB3.POFFSET	491
19.13.10 FB3.POUT	492
19.13.11 FB3.PUNIT	493
19.14 FBUS Parameters	494
19.14.1 FBUS.PARAM1 TO FBUS.PARAM10	495
19.14.2 FBUS.PLLSTATE	497
19.14.3 FBUS.PLLTHRESH	498
19.14.4 FBUS.PROTECTION	499
19.14.5 FBUS.REMOTE	501
19.14.6 FBUS.SAMPLEPERIOD	502
19.14.7 FBUS.STATE	503
19.14.8 FBUS.SYNCACT	504
19.14.9 FBUS.SYNCDIST	505
19.14.10 FBUS.SYNCWND	506
19.14.11 FBUS.TYPE	507
19.15 GUI Parameters	508
19.15.1 GUI.DISPLAY	509
19.15.2 GUI.DISPLAYS	510
19.15.3 GUI.PARAM01	511
19.15.4 GUI.PARAM02	512
19.15.5 GUI.PARAM03	513
19.15.6 GUI.PARAM04	514
19.15.7 GUI.PARAM05	515
19.15.8 GUI.PARAM06	516
19.15.9 GUI.PARAM07	517
19.15.10 GUI.PARAM08	518
19.15.11 GUI.PARAM09	519
19.15.12 GUI.PARAM10	520
19.16 HWLS Parameters	521
19.16.1 HWLS.NEGSTATE	522
19.16.2 HWLS.POSSTATE	523
19.17 IL Parameters	524
19.17.1 IL.BUSFF	526
19.17.2 IL.CMD	527
19.17.3 IL.CMDACC	528
19.17.4 IL.CMDU	529
19.17.5 IL.DCMD	530

19.17.6 IL.DFB	531
19.17.7 IL.DIFOLD	532
19.17.8 IL.FB	533
19.17.9 IL.FBSOURCE	534
19.17.10 IL.FF	535
19.17.11 IL.FOLDFTHRESH	536
19.17.12 IL.FOLDFTHRESHU	537
19.17.13 IL.FOLDWTHRESH	538
19.17.14 IL.FRICTION	539
19.17.15 IL.IFOLD	540
19.17.16 IL.IUFB	541
19.17.17 IL.IVFB	542
19.17.18 IL.KACFF	543
19.17.19 IL.KBUSFF	544
19.17.20 IL.KP	545
19.17.21 IL.KPDRATIO	546
19.17.22 IL.KPLOOKUPINDEX	547
19.17.23 IL.KPLOOKUPVALUE	548
19.17.24 IL.KPLOOKUPVALUES	549
19.17.25 IL.KVFF	550
19.17.26 IL.LIMITN	551
19.17.27 IL.LIMITP	552
19.17.28 IL.MFOLDD	553
19.17.29 IL.MFOLDR	554
19.17.30 IL.MFOLDT	555
19.17.31 IL.MI2T	556
19.17.32 IL.MI2TWTHRESH	557
19.17.33 IL.MIFOLD	558
19.17.34 IL.MIMODE	559
19.17.35 IL.OFFSET	560
19.17.36 IL.VCMD	561
19.17.37 IL.VUFB	562
19.17.38 IL.VVFB	563
19.18 IP Parameters	564
19.18.1 IP.ADDRESS	565
19.18.2 IP.GATEWAY	566
19.18.3 IP.MODE	567
19.18.4 IP.RESET	568
19.18.5 IP.SUBNET	569
19.19 LOAD Parameters	570
19.19.1 LOAD.INERTIA	571
19.20 MOTOR Parameters	572
19.20.1 MOTOR.AUTOSET	574
19.20.2 MOTOR.BRAKE	576
19.20.3 MOTOR.BRAKEIMM	577
19.20.4 MOTOR.BRAKERLS	578
19.20.5 MOTOR.BRAKESTATE	579

19.20.6 MOTOR.CTF0	580
19.20.7 MOTOR.FIELDWEAKENING	581
19.20.8 MOTOR.ICONT	582
19.20.9 MOTOR.IDDATAVALID	583
19.20.10 MOTOR.IDMAX	584
19.20.11 MOTOR.IMID	585
19.20.12 MOTOR.IMTR	586
19.20.13 MOTOR.INERTIA	588
19.20.14 MOTOR.IPEAK	589
19.20.15 MOTOR.KE	590
19.20.16 MOTOR.KT	591
19.20.17 MOTOR.LDLL	592
19.20.18 MOTOR.LISAT	593
19.20.19 MOTOR.LQLL	594
19.20.20 MOTOR.NAME	595
19.20.21 MOTOR.PHASE	596
19.20.22 MOTOR.PHSADVK1	597
19.20.23 MOTOR.PHSADVK2	598
19.20.24 MOTOR.PITCH	599
19.20.25 MOTOR.POLES	600
19.20.26 MOTOR.R	601
19.20.27 MOTOR.RTYPE	602
19.20.28 MOTOR.SUPPORTEDPARAMS	603
19.20.29 MOTOR.TBRAKEAPP	604
19.20.30 MOTOR.TBRAKERLS	605
19.20.31 MOTOR.TBRAKETO	606
19.20.32 MOTOR.TEMP	607
19.20.33 MOTOR.TEMPC	608
19.20.34 MOTOR.TEMPFAULT	609
19.20.35 MOTOR.TEMPWARN	610
19.20.36 MOTOR.TYPE	611
19.20.37 MOTOR.VMAX	613
19.20.38 MOTOR.VOLTMAX	614
19.20.39 MOTOR.VOLTMIN	615
19.20.40 MOTOR.VOLTRATED	616
19.20.41 MOTOR.VRATED	617
19.21 PL Parameters	618
19.21.1 PL.CMD	619
19.21.2 PL.ERR	620
19.21.3 PL.ERRFTHRESH	621
19.21.4 PL.ERRMODE	623
19.21.5 PL.ERRWTHRESH	624
19.21.6 PL.FB	625
19.21.7 PL.FBSOURCE	626
19.21.8 PL.FILTERTIME	627
19.21.9 PL.INTINMAX	628
19.21.10 PL.INTOUTMAX	630

19.21.11 PL.KI	632
19.21.12 PL.KP	633
19.21.13 PL.PDELAY	634
19.22 REC Parameters	635
19.22.1 REC.ACTIVE	636
19.22.2 REC.CH1 to REC.CH6	637
19.22.3 REC.DONE	638
19.22.4 REC.GAP	639
19.22.5 REC.NUMPOINTS	640
19.22.6 REC.OFF	641
19.22.7 REC.RECPRMLIST	642
19.22.8 REC.RETRIEVE	643
19.22.9 REC.RETRIEVEDATA	644
19.22.10 REC.RETRIEVEFRMT	646
19.22.11 REC.RETRIEVEHDR	647
19.22.12 REC.RETRIEVESIZE	648
19.22.13 REC.STOCTYPE	649
19.22.14 REC.TRIG	650
19.22.15 REC.TRIGPARAM	651
19.22.16 REC.TRIGPOS	652
19.22.17 REC.TRIGPRMLIST	654
19.22.18 REC.TRIGSLOPE	655
19.22.19 REC.TRIGTYPE	656
19.22.20 REC.TRIGVAL	657
19.23 REGEN Parameters	658
19.23.1 REGEN.POWER	659
19.23.2 REGEN.POWERFILTERED	660
19.23.3 REGEN.REXT	661
19.23.4 REGEN.TEXT	662
19.23.5 REGEN.TYPE	663
19.23.6 REGEN.WATTEXT	664
19.24 SM Parameters	665
19.24.1 SM.ACC	666
19.24.2 SM.DEC	667
19.24.3 SM.I1	668
19.24.4 SM.I2	669
19.24.5 SM.MODE	670
19.24.6 SM.MOVE	673
19.24.7 SM.T1	674
19.24.8 SM.T2	675
19.24.9 SM.V1	676
19.24.10 SM.V2	677
19.25 STO Parameters	678
19.25.1 STO.STATE	679
19.26 SWLS Parameters	680
19.26.1 SWLS.EN	681
19.26.2 SWLS.LIMIT0	682

19.26.3 SWLS.LIMIT1	683
19.26.4 SWLS.STATE	684
19.27 TEMP Parameters	685
19.27.1 TEMP.CONTROL	686
19.27.2 TEMP.POWER1 to TEMP.POWER3	687
19.28 USER Parameters	688
19.28.1 USER.INT1 to USER.INT24	689
19.29 VBUS Parameters	690
19.29.1 VBUS.HALFVOLT	691
19.29.2 VBUS.OVFTHRESH	692
19.29.3 VBUS.OVWTHRESH	693
19.29.4 VBUS.RMSLIMIT	694
19.29.5 VBUS.UVFTHRESH	695
19.29.6 VBUS.UVMODE	696
19.29.7 VBUS.UVWTHRESH	697
19.29.8 VBUS.VALUE	698
19.30 VL Parameters	699
19.30.1 VL.ARPF1 TO VL.ARPF4	700
19.30.2 VL.ARPQ1 TO VL.ARPQ4	702
19.30.3 VL.ARTYPE1 TO VL.ARTYPE4	704
19.30.4 VL.ARZF1 TO VL.ARZF4	705
19.30.5 VL.ARZQ1 TO VL.ARZQ4	706
19.30.6 VL.BUSFF	707
19.30.7 VL.CMD	708
19.30.8 VL.CMDU	709
19.30.9 VL.ERR	710
19.30.10 VL.FB	711
19.30.11 VL.FBFILTER	712
19.30.12 VL.FBSOURCE	713
19.30.13 VL.FBUNFILTERED	714
19.30.14 VL.FF	715
19.30.15 VL.FFDELAY	716
19.30.16 VL.GENMODE	717
19.30.17 VL.KBUSFF	718
19.30.18 VL.KI	719
19.30.19 VL.KO	720
19.30.20 VL.KP	721
19.30.21 VL.KVFF	723
19.30.22 VL.LIMITN	724
19.30.23 VL.LIMITP	726
19.30.24 VL.LMJR	727
19.30.25 VL.MODEL	728
19.30.26 VL.OBSBW	729
19.30.27 VL.OBSMODE	730
19.30.28 VL.THRESH	731
19.30.29 VL.VFTHRESH	733
19.31 WS Parameters	734

19.31.1 WS.ARM	735
19.31.2 WS.CHECKMODE	736
19.31.3 WS.CHECKT	737
19.31.4 WS.CHECKV	738
19.31.5 WS.DISARM	739
19.31.6 WS.DISTMAX	740
19.31.7 WS.DISTMIN	741
19.31.8 WS.FREQ	742
19.31.9 WS.IMAX	743
19.31.10 WS.MODE	744
19.31.11 WS.NUMLOOPS	745
19.31.12 WS.STATE	746
19.31.13 WS.T	747
19.31.14 WS.TDELAY1	748
19.31.15 WS.TDELAY2	749
19.31.16 WS.TDELAY3	750
19.31.17 WS.TDELAY4	751
19.31.18 WS.TIRAMP	752
19.31.19 WS.TSTANDSTILL	753
19.31.20 WS.VTHRESH	754
19.32 EtherCAT Profile	755
19.32.1 Slave Register	756
19.32.2 AL Event (Interrupt Event) and Interrupt Enable	757
19.32.2.1 Interrupt Enable Register (Address 0x0204:0x0205)	757
19.32.2.2 AL Event Request (Address 0x0220:0x0221)	758
19.32.3 Phase Run-Up	759
19.32.3.1 AL Control (Address 0x0120:0x0121)	759
19.32.3.2 AL Status (Address 0x0130:0x0131)	759
19.32.3.3 AL Status Code (Address 0x0134:0x0135)	760
19.32.3.4 EtherCAT communication phases	760
19.32.4 CANopen over EtherCAT (CoE) State Machine	762
19.32.4.1 Status Description	762
19.32.4.2 Commands in the Control Word	764
19.32.4.3 State Machine Bits (status word)	766
19.32.5 Fixed PDO Mappings	767
19.32.6 Flexible PDO Mappings	769
19.32.6.1 Example: Flexible PDO Mapping	771
19.32.7 Supported Cyclical Setpoint and Actual Values	775
19.32.8 Supported Operation Modes	777
19.32.9 Adjusting EtherCAT Cycle Time	777
19.32.10 Maximum Cycle Times depending on operation mode	777
19.32.11 Synchronization	779
19.32.11.1 Synchronization behavior with distributed clocks (DC) enabled	779
19.32.11.2 Synchronization behavior with distributed clocks (DC) disabled	779
19.32.12 Latch Control Word and Latch Status Word	780
19.32.13 Mailbox Handling	782
19.32.13.1 Mailbox Output	783

19.32.13.2 Mailbox Input	785
19.32.13.3 Example: Mailbox Access	787
19.32.14 Fieldbus Parameters	788
19.32.15 EEPROM Content	789
19.33 Appendix	791
19.33.1 CANopen Emergency Messages and Error Codes	791
19.33.2 Object Dictionary	797
19.33.2.1 Float Scaling	797
19.33.2.2 Effectiveness of PDO set-points	797
19.33.2.3 Communication SDOs	797
19.33.2.4 Manufacturer specific SDOs	801
19.33.2.5 Profile specific SDOs	818
19.33.3 Object descriptions	821
19.33.3.1 Object 1000h: Device Type (DS301)	821
19.33.3.2 Object 1001h: Error register (DS301)	822
19.33.3.3 Object 1002h: Manufacturer Status Register (DS301)	823
19.33.3.4 Object 1003h: Predefined Error Field (DS301)	824
19.33.3.5 Object 1005h: COB-ID of the SYNC Message (DS301)	825
19.33.3.6 Object 1006h: Communication Cycle Period (DS301)	825
19.33.3.7 Object 1008h: Manufacturer Device Name (DS301)	826
19.33.3.8 Object 1009h: Manufacturer Hardware Version	826
19.33.3.9 Object 100Ah: Manufacturer Software Version (DS301)	826
19.33.3.10 Object 100Ch: Guard Time (DS301)Response monitoring	827
19.33.3.11 Object 100Dh: Lifetime Factor (DS301)	827
19.33.3.12 Object 1010h: Store Parameters (DS301)	828
19.33.3.13 Object 1011h: Restore Default Parameters DS301	829
19.33.3.14 Object 1012h: COB-ID of the Time Stamp (DS301)	830
19.33.3.15 Object 1014h: COB-ID for Emergency Message (DS301)	830
19.33.3.16 Object 1016h: Consumer Heartbeat Time	831
19.33.3.17 Object 1017h: Producer Heartbeat Time	832
19.33.3.18 Object 1018h: Identity Object (DS301)	832
19.33.3.19 Object 1026h: OS Prompt	834
19.33.3.20 Objects 1400-1403h: 1st - 4th RxPDO communication parameter (DS301)	835
19.33.3.21 Objects 1600-1603h: 1st - 4th RxPDO mapping parameter (DS301)	836
19.33.3.22 Objects 1800-1803h: 1st - 4th TxPDO communication parameter (DS301)	838
19.33.3.23 Objects 1A00-1A03h: 1st - 4th TxPDO mapping parameter (DS301)	841
19.33.3.24 Object 1C12h: RxPDO assign (DS301)	842
19.33.3.25 Object 1C13h: TxPDO assign (DS301)	843
19.33.3.26 Object 2000h: System Warnings	844
19.33.3.27 Object 2001h: System Faults	844
19.33.3.28 Object 2002h: Manufacturer status bytes	845
19.33.3.29 Object 2011h: DRV.RUNTIME in seconds	846
19.33.3.30 Object 2012h: Fault history: Fault numbers	847
19.33.3.31 Object 2013h: Fault history: Time stamps	848
19.33.3.32 Object 2014-2017h: 1st-4th Mask 1 to 4 for Transmit-PDO	849
19.33.3.33 Object 2018h: Firmware Version	850
19.33.3.34 Object 2026h: ASCII Channel	852

19.33.3.35	Object 204Ch: PV Scaling Factor	853
19.33.3.36	Object 2071h: Target Current	854
19.33.3.37	Object 2077h: Current Actual Value	854
19.33.3.38	Object 20A0h: Latch position 1, positive edge	854
19.33.3.39	Object 20A1h: Latch position 1, negative edge	856
19.33.3.40	Object 20A2h: Latch position 2, positive edge	856
19.33.3.41	Object 20A3h: Latch position 2, negative edge	857
19.33.3.42	Object 20A4h: Latch Control Register	857
19.33.3.43	Object 20A5h: Latch Status Register	858
19.33.3.44	Object 20A6h: Latch position 1, positive or negative edge	858
19.33.3.45	Object 20A7h: Latch position 2, positive or negative edge	860
19.33.3.46	Object 20B8h: Reset of changed input information	860
19.33.3.47	Object 345Ah: Brake Control	861
19.33.3.48	Object 3474h: Parameters for digital inputs	864
19.33.3.49	Object 3475h: Parameters for digital outputs	865
19.33.3.50	Object 3496h: Fieldbus synchronization parameters	866
19.33.3.51	Object 6040h: Control word (DS402)	868
19.33.3.52	Object 6041h: Status word (DS402)	869
19.33.3.53	Object 6060h: Modes of Operation (DS402)	872
19.33.3.54	Object 6061h: Modes of Operation Display (DS402)	873
19.33.3.55	Object 6063h: position actual value* (DS402)	873
19.33.3.56	Object 6064h: position actual value (DS402)	873
19.33.3.57	Object 6065h: Following error window	874
19.33.3.58	Object 606Ch: Velocity actual value (DS402)	874
19.33.3.59	Object 6071h: Target torque (DS402)	875
19.33.3.60	Object 6073h: Max current (DS402)	875
19.33.3.61	Object 6077h: Torque actual value (DS402)	875
19.33.3.62	Object 607Ah: Target position (DS402)	876
19.33.3.63	Object 607Ch: Homing offset (DS402)	876
19.33.3.64	Object 607Dh: Software position limit (DS402)	877
19.33.3.65	Object 6081h: Profile velocity (DS402)	878
19.33.3.66	Object 6083h: Profile acceleration (DS402)	878
19.33.3.67	Object 6084h: Profile deceleration (DS402)	878
19.33.3.68	Object 608Fh: Position encoder resolution (DS402)	880
19.33.3.69	Object 6091h: Gear Ratio (DS402)	881
19.33.3.70	Object 6092h: Feed constant (DS402)	882
19.33.3.71	Object 6098h: Homing method (DS402)	883
19.33.3.72	Object 6099h: Homing speeds (DS402)	884
19.33.3.73	Object 609Ah: Homing acceleration (DS402)	886
19.33.3.74	Object 60B1h: Velocity Offset	886
19.33.3.75	Object 60B2h: Torque Offset	886
19.33.3.76	Object 60B8h: Touch probe function	887
19.33.3.77	Object 60B9h: Touch probe status	889
19.33.3.78	Object 60BAh: Touch probe 1 positive edge	890
19.33.3.79	Object 60BBh: Touch probe 1 negative edge	890
19.33.3.80	Object 60BCh: Touch probe 2 positive edge	890
19.33.3.81	Object 60BDh: Touch probe 2 negative edge	891

19.33.3.82	Object 60C0h: Interpolation sub mode select	891
19.33.3.83	Object 60C1h: Interpolation data record	892
19.33.3.84	Object 60C2h: Interpolation time period	893
19.33.3.85	Object 60C4h: Interpolation data configuration	894
19.33.3.86	Object 60D0h: Touch probe source	896
19.33.3.87	Object 60E0h: Positive Torque Limit Value	897
19.33.3.88	Object 60E1h: Negative Torque Limit Value	897
19.33.3.89	Object 60E4h: Additional position actual value	898
19.33.3.90	Object 60E8h: Additional gear ratio – motor shaft revolutions	899
19.33.3.91	Object 60E9h: Additional feed constant – feed	900
19.33.3.92	Object 60EDh: Additional gear ratio – driving shaft revolutions	901
19.33.3.93	Object 60EEh: Additional feed constant - driving shaft revolutions	902
19.33.3.94	Object 60F4h: Following error actual value (DS402)	903
19.33.3.95	Object 60FCh: Position demand internal value (DS402)	904
19.33.3.96	Object 60FDh: Digital inputs (DS402)	904
19.33.3.97	Object 60FEh: Digital outputs (DS402)	905
19.33.3.98	Object 60FFh: Target velocity (DS402)	906
19.33.3.99	Object 6502h: Supported drive modes (DS402)	906
20	EtherCAT Profile	909
20.1	Slave Register	910
20.2	AL Event (Interrupt Event) and Interrupt Enable	911
20.2.1	Interrupt Enable Register (Address 0x0204:0x0205)	911
20.2.2	AL Event Request (Address 0x0220:0x0221)	912
20.3	Phase Run-Up	913
20.3.1	AL Control (Address 0x0120:0x0121)	913
20.3.2	AL Status (Address 0x0130:0x0131)	913
20.3.3	AL Status Code (Address 0x0134:0x0135)	914
20.3.4	EtherCAT communication phases	914
20.4	CANopen over EtherCAT (CoE) State Machine	916
20.4.1	Status Description	916
20.4.2	Commands in the Control Word	918
20.4.3	State Machine Bits (status word)	920
20.5	Fixed PDO Mappings	921
20.6	Flexible PDO Mappings	923
20.6.1	Example: Flexible PDO Mapping	925
20.7	Supported Cyclical Setpoint and Actual Values	929
20.8	Supported Operation Modes	931
20.9	Adjusting EtherCAT Cycle Time	931
20.10	Maximum Cycle Times depending on operation mode	931
20.11	Synchronization	933
20.11.1	Synchronization behavior with distributed clocks (DC) enabled	933
20.11.2	Synchronization behavior with distributed clocks (DC) disabled	933
20.12	Latch Control Word and Latch Status Word	934
20.13	Mailbox Handling	936
20.13.1	Mailbox Output	937
20.13.2	Mailbox Input	939
20.13.3	Example: Mailbox Access	941

20.14	Fieldbus Parameters	942
20.15	EEProm Content	943
21	Appendix	945
21.1	CANopen Emergency Messages and Error Codes	945
21.2	Object Dictionary	951
21.2.1	Float Scaling	951
21.2.2	Effectiveness of PDO set-points	951
21.2.3	Communication SDOs	951
21.2.4	Manufacturer specific SDOs	955
21.2.5	Profile specific SDOs	972
21.3	Object descriptions	975
21.3.1	Object 1000h: Device Type (DS301)	975
21.3.2	Object 1001h: Error register (DS301)	976
21.3.3	Object 1002h: Manufacturer Status Register (DS301)	977
21.3.4	Object 1003h: Predefined Error Field (DS301)	978
21.3.5	Object 1005h: COB-ID of the SYNC Message (DS301)	979
21.3.6	Object 1006h: Communication Cycle Period (DS301)	979
21.3.7	Object 1008h: Manufacturer Device Name (DS301)	980
21.3.8	Object 1009h: Manufacturer Hardware Version	980
21.3.9	Object 100Ah: Manufacturer Software Version (DS301)	980
21.3.10	Object 100Ch: Guard Time (DS301)Response monitoring	981
21.3.11	Object 100Dh: Lifetime Factor (DS301)	981
21.3.12	Object 1010h: Store Parameters (DS301)	982
21.3.13	Object 1011h: Restore Default Parameters DS301	983
21.3.14	Object 1012h: COB-ID of the Time Stamp (DS301)	984
21.3.15	Object 1014h: COB-ID for Emergency Message (DS301)	984
21.3.16	Object 1016h: Consumer Heartbeat Time	985
21.3.17	Object 1017h: Producer Heartbeat Time	986
21.3.18	Object 1018h: Identity Object (DS301)	986
21.3.19	Object 1026h: OS Prompt	988
21.3.20	Objects 1400-1403h: 1st - 4th RxPDO communication parameter (DS301)	989
21.3.21	Objects 1600-1603h: 1st - 4th RxPDO mapping parameter (DS301)	990
21.3.22	Objects 1800-1803h: 1st - 4th TxPDO communication parameter (DS301)	992
21.3.23	Objects 1A00-1A03h: 1st - 4th TxPDO mapping parameter (DS301)	995
21.3.24	Object 1C12h: RxPDO assign (DS301)	996
21.3.25	Object 1C13h: TxPDO assign (DS301)	997
21.3.26	Object 2000h: System Warnings	998
21.3.27	Object 2001h: System Faults	998
21.3.28	Object 2002h: Manufacturer status bytes	999
21.3.29	Object 2011h: DRV.RUNTIME in seconds	1000
21.3.30	Object 2012h: Fault history: Fault numbers	1001
21.3.31	Object 2013h: Fault history: Time stamps	1002
21.3.32	Object 2014-2017h: 1st-4th Mask 1 to 4 for Transmit-PDO	1003
21.3.33	Object 2018h: Firmware Version	1004
21.3.34	Object 2026h: ASCII Channel	1006
21.3.35	Object 204Ch: PV Scaling Factor	1007
21.3.36	Object 2071h: Target Current	1008

21.3.37 Object 2077h: Current Actual Value	1008
21.3.38 Object 20A0h: Latch position 1, positive edge	1008
21.3.39 Object 20A1h: Latch position 1, negative edge	1010
21.3.40 Object 20A2h: Latch position 2, positive edge	1010
21.3.41 Object 20A3h: Latch position 2, negative edge	1011
21.3.42 Object 20A4h: Latch Control Register	1011
21.3.43 Object 20A5h: Latch Status Register	1013
21.3.44 Object 20A6h: Latch position 1, positive or negative edge	1013
21.3.45 Object 20A7h: Latch position 2, positive or negative edge	1015
21.3.46 Object 20B8h: Reset of changed input information	1015
21.3.47 Object 345Ah: Brake Control	1016
21.3.48 Object 3474h: Parameters for digital inputs	1019
21.3.49 Object 3475h: Parameters for digital outputs	1020
21.3.50 Object 3496h: Fieldbus synchronization parameters	1021
21.3.51 Object 6040h: Control word (DS402)	1023
21.3.52 Object 6041h: Status word (DS402)	1024
21.3.53 Object 6060h: Modes of Operation (DS402)	1027
21.3.54 Object 6061h: Modes of Operation Display (DS402)	1028
21.3.55 Object 6063h: position actual value* (DS402)	1028
21.3.56 Object 6064h: position actual value (DS402)	1028
21.3.57 Object 6065h: Following error window	1029
21.3.58 Object 606Ch: Velocity actual value (DS402)	1029
21.3.59 Object 6071h: Target torque (DS402)	1030
21.3.60 Object 6073h: Max current (DS402)	1030
21.3.61 Object 6077h: Torque actual value (DS402)	1030
21.3.62 Object 607Ah: Target position (DS402)	1031
21.3.63 Object 607Ch: Homing offset (DS402)	1031
21.3.64 Object 607Dh: Software position limit (DS402)	1032
21.3.65 Object 6081h: Profile velocity (DS402)	1033
21.3.66 Object 6083h: Profile acceleration (DS402)	1033
21.3.67 Object 6084h: Profile deceleration (DS402)	1033
21.3.68 Object 608Fh: Position encoder resolution (DS402)	1035
21.3.69 Object 6091h: Gear Ratio (DS402)	1036
21.3.70 Object 6092h: Feed constant (DS402)	1037
21.3.71 Object 6098h: Homing method (DS402)	1038
21.3.72 Object 6099h: Homing speeds (DS402)	1039
21.3.73 Object 609Ah: Homing acceleration (DS402)	1041
21.3.74 Object 60B1h: Velocity Offset	1041
21.3.75 Object 60B2h: Torque Offset	1041
21.3.76 Object 60B8h: Touch probe function	1042
21.3.77 Object 60B9h: Touch probe status	1044
21.3.78 Object 60BAh: Touch probe 1 positive edge	1045
21.3.79 Object 60BBh: Touch probe 1 negative edge	1045
21.3.80 Object 60BCh: Touch probe 2 positive edge	1045
21.3.81 Object 60BDh: Touch probe 2 negative edge	1046
21.3.82 Object 60C0h: Interpolation sub mode select	1046
21.3.83 Object 60C1h: Interpolation data record	1047

21.3.84 Object 60C2h: Interpolation time period	1048
21.3.85 Object 60C4h: Interpolation data configuration	1049
21.3.86 Object 60D0h: Touch probe source	1051
21.3.87 Object 60E0h: Positive Torque Limit Value	1052
21.3.88 Object 60E1h: Negative Torque Limit Value	1052
21.3.89 Object 60E4h: Additional position actual value	1053
21.3.90 Object 60E8h: Additional gear ratio – motor shaft revolutions	1054
21.3.91 Object 60E9h: Additional feed constant – feed	1055
21.3.92 Object 60EDh: Additional gear ratio – driving shaft revolutions	1056
21.3.93 Object 60EEh: Additional feed constant - driving shaft revolutions	1057
21.3.94 Object 60F4h: Following error actual value (DS402)	1058
21.3.95 Object 60FCh: Position demand internal value (DS402)	1059
21.3.96 Object 60FDh: Digital inputs (DS402)	1059
21.3.97 Object 60FEh: Digital outputs (DS402)	1060
21.3.98 Object 60FFh: Target velocity (DS402)	1061
21.3.99 Object 6502h: Supported drive modes (DS402)	1061
22 Glossary	1063
23 Index	1075

2 Welcome to AKD PDMM User Guide

Welcome to the AKD PDMM User Guide, a guide for installing, setting up, and using an AKD PDMM. Complete product documentation in pdf or online help format is included on your installation disk. Product manuals are also posted on the [Kollmorgen website](#) and are updated on the website as needed between releases. Check the website for the most current manuals.

The documentation available on the Kollmorgen website includes the following:

Related documents for the AKD PDMM series include:

- *AKD PDMM Quick Start* (also provided in hard copy). This guide provides instructions for initial drive setup and connection to a network.
- *AKD PDMM Installation Manual* (also provided in hard copy for EU customers). This manual provides instructions for installation and drive setup.
- *AKD PDMM Users Manual*. This manual describes how to use your drive in common applications. It also provides tips for maximizing your system performance with the AKD PDMM.
- *Accessories Manual*. This manual provides documentation for accessories like cables and regen resistors used with AKD PDMM. Regional versions of this manual exist.

Hardware Revision (HR)

AKD-B/P-NA	AKD-B/P-NB	AKD-M	AKD-T-IC	Firmware/Workbench	KAS IDE	Export Classification	Remarks
A	-	-	-	from 1.3	-	3A225	Start revision, export control
C	-	-	-	from 1.5	-	3A225	STO certified, PROFINET RT released, export control
-	D	DB	DA	from 1.6	from 2.5	3A225	Control board revision 9, AKD PDMM Start revision, AKD BASIC-IC Start revision, export control
D	E	EB	EA	from 1.13	from 2.9	-	Hardware revision for export classification traceability purposes

Trademarks

- AKD PDMM is a registered trademark of Kollmorgen Corporation
- EnDat is a registered trademark of Dr. Johannes Heidenhain GmbH
- EtherCAT is a registered trademark and patented technology, licensed by Beckhoff Automation GmbH
- Ethernet/IP is a registered trademark of ODVA, Inc.
- Ethernet/IP Communication Stack: copyright (c) 2009, Rockwell Automation
- sercos[®] is a registered trademark of sercos[®] international e.V.
- HIPERFACE is a registered trademark of Max Stegmann GmbH
- PROFINET is a registered trademark of PROFIBUS and PROFINET International (PI)
- SIMATIC is a registered trademark of SIEMENS AG
- Windows is a registered trademark of Microsoft Corporation

Current patents

- US Patent 5,162,798 (used in control card R/D)
- US Patent 5,646,496 (used in control card R/D and 1 Vp-p feedback interface)
- US Patent 6,118,241 (used in control card simple dynamic braking)
- US Patent 8,154,228 (Dynamic Braking For Electric Motors)
- US Patent 8,214,063 (Auto-tune of a Control System Based on Frequency Response)

Patents referring to fieldbus functions are listed in the matching fieldbus manual.

Technical changes which improve the performance of the device may be made without prior notice.

Printed in the United States of America

This document is the intellectual property of Kollmorgen. All rights reserved. No part of this work may be reproduced in any form (by photocopying, microfilm or any other method) or stored, processed, copied or distributed by electronic means without the written permission of Kollmorgen.

3 AKD PDMM Models

AKD PDMM drive models are available in a variety of combinations of features. The part number identifies the features included in your model.

NOTE

AKD PDMM is only available for EtherCAT field busses.

The figure below shows part number identification for drive features. Features available in the AKD PDMM are marked bold green.

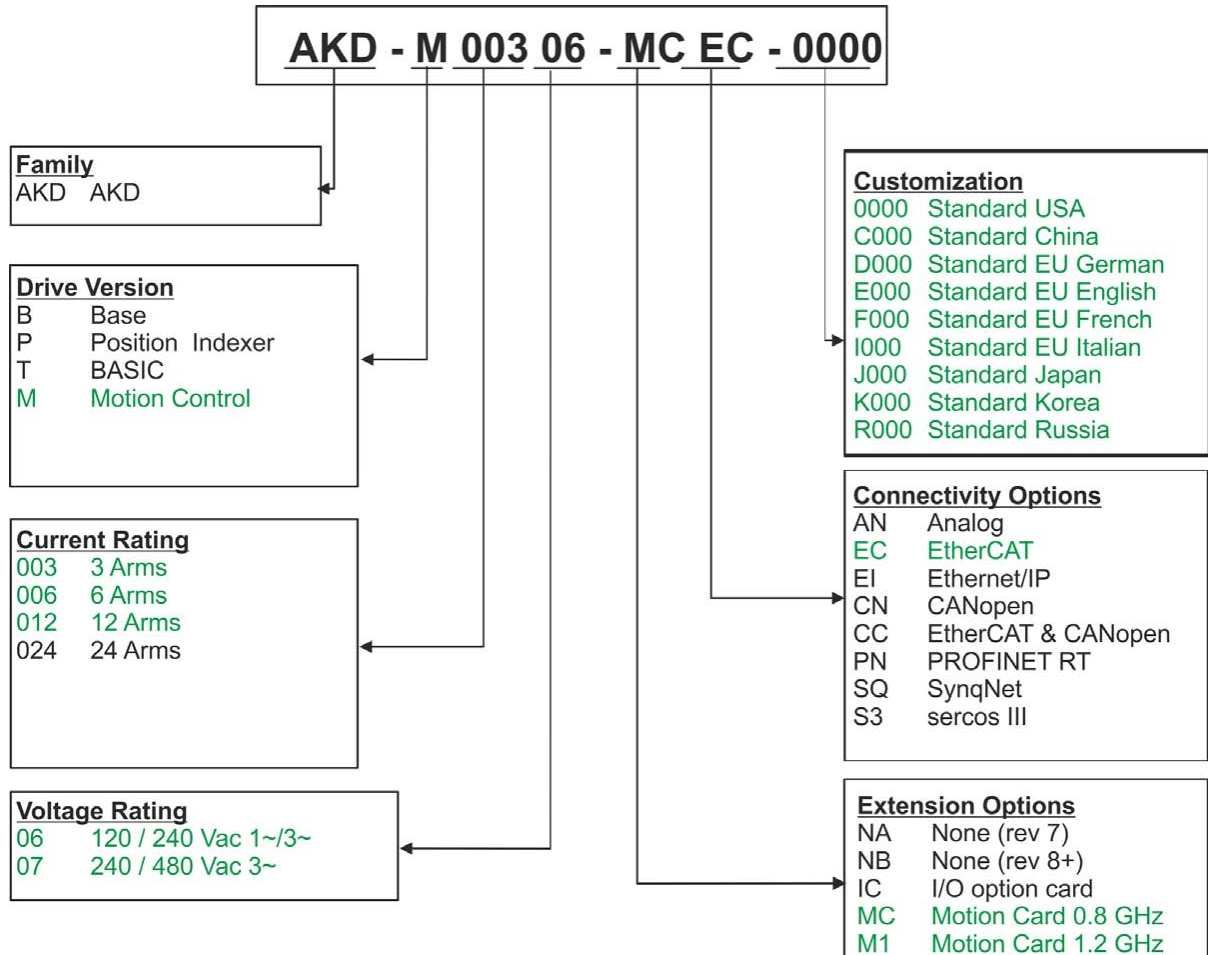

This page intentionally left blank.

4 Software Setup

4.1 Install and Start the KAS IDE

Once the Kollmorgen Automation Suite Integrated Development Environment (KAS IDE) installation is complete, click the IDE icon to launch the program.

NOTE

The KVB software used for developing an HMI display does not install with the KAS IDE and must be installed separately.

Begin a new project in the KAS IDE by selecting **File > New**. This will launch the **Add a New Controller** window.

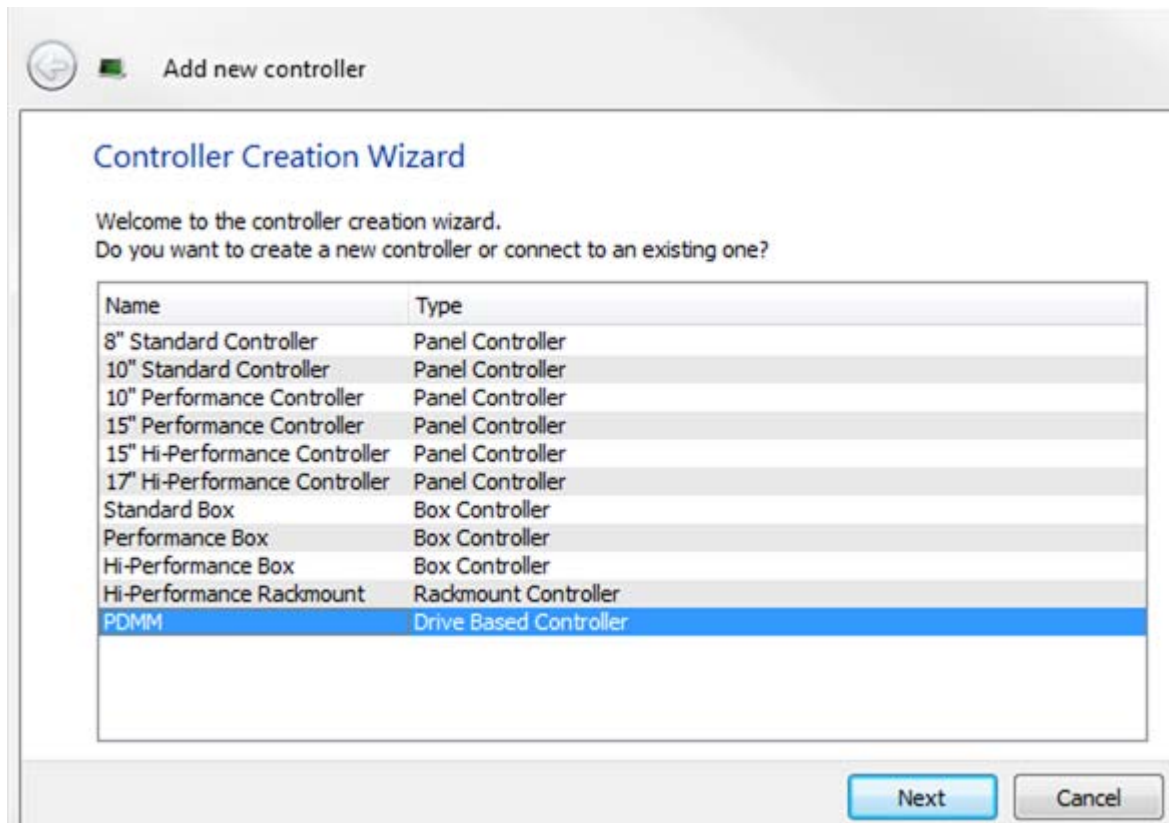

Figure 4-1: Add a New Controller

Select your AKD PDMM model from the list and click Next. You will then be prompted to select an application template:

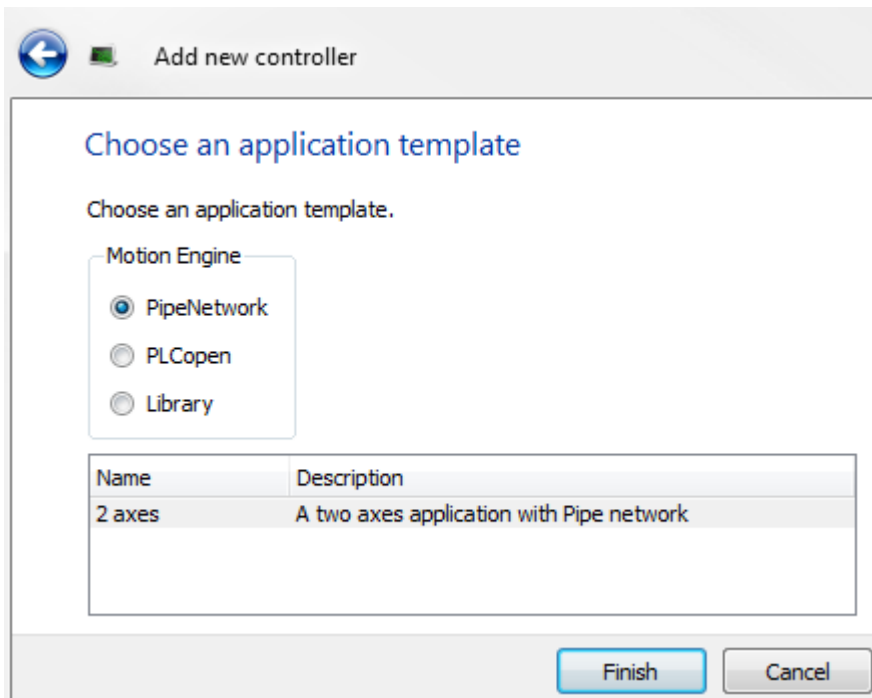

Figure 4-2: Select Application Template

Choose from PipeNetwork, PLCopen, or Library, and click Finish. The controller will then be added to the project view.

To associate the project with the IP address of the PDMM controller, right click on the Controller option in the Project View.

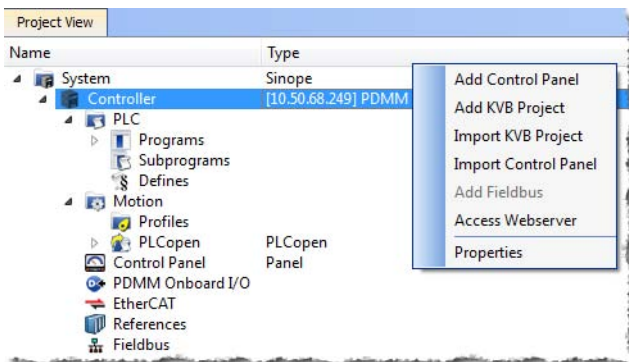

Figure 4-3: Controller Selection

Select Properties and the following screen appears:

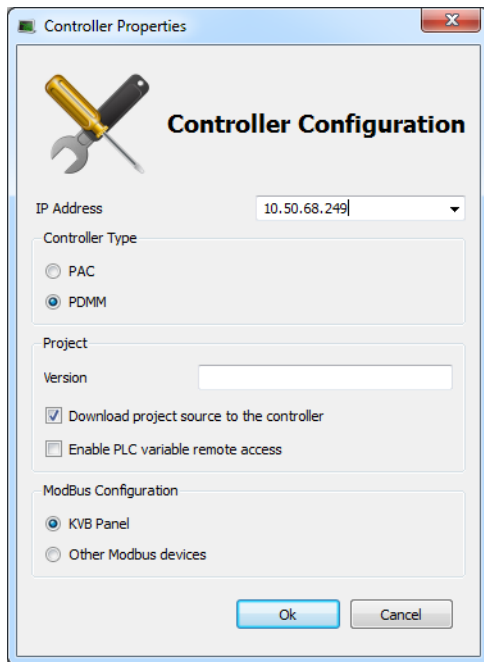

Figure 4-4: Controller Properties

Type in the IP address of the PDMM, set the Controller Type to PDMM and click OK.

4.2 KAS IDE Project View

The KAS IDE contains tools for configuring the EtherCAT network, setting up and tuning the drives, adding and configuring HMIs, and creating a PLC program. For more complete information see the KAS IDE User Guide.

Once a project (new or saved) is opened, the user can open a variety of items to build a project from the Project Explorer:

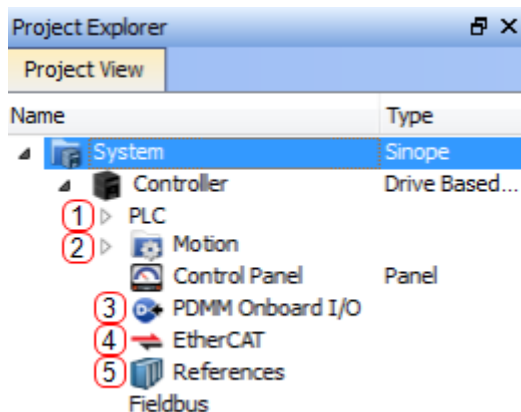

1. Create PLC Programs
2. Add Motion
3. Configure Resident I/O
4. Configure Drives and Remote I/O
5. Add Additional Reference Documents

Figure 4-5: Project View

4.3 Configuring the Drives and Remote I/O

All drives, including the drive in the PDMM itself and the Remote I/O, can be configured by the IDE. In order to connect to an EtherCAT device you must first compile your project. After the project is compiled you must connect to the target:



1. Compile Project
2. Connect to Target

Figure 4-6: Compile and Connect

Next click on the EtherCAT item in the project view to bring up the EtherCAT Devices screen in the IDE workspace. Click on Scan Devices and the IDE will launch a view which automatically identifies your connected device(s). Click OK, to add these devices to the project.

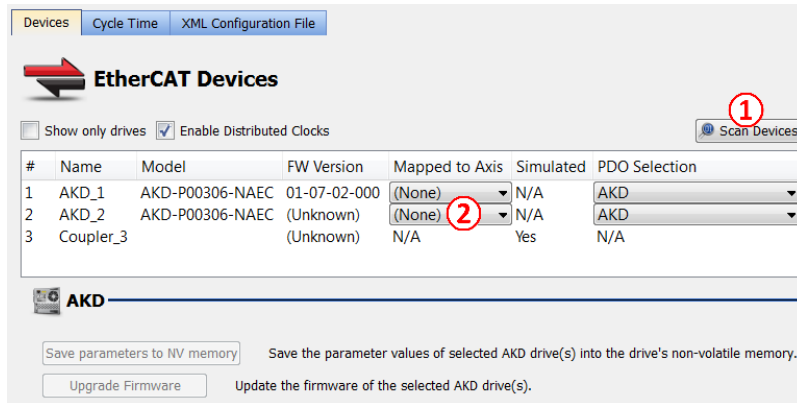

1. Go to the EtherCAT Devices view and press Scan Devices
2. Mapped to Axis in the Application

Figure 4-7: Scan Devices & Mapped to Axis

The devices are added to the project view:

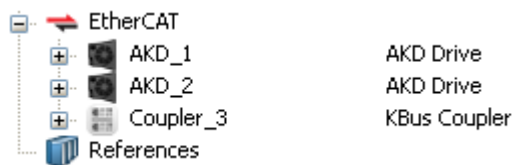

Figure 4-8: Devices Added to Project

To communicate directly with a drive without running a project, first compile and download the project:

Step 1: Compile Project

Step 2: Download Project



1. Compile Project
2. Download Project

Figure 4-9: Compile and Download

Online Configuration Mode must also be active. Click on the EtherCAT item in the project tree and then click on the Online Configuration Mode button next to Scan Devices:

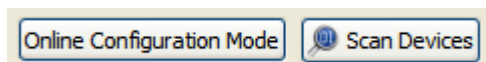

Figure 4-10: Online Configuration Mode

Online Configuration Mode is now active. To configure a particular item in the EtherCAT network, click on the item in the project tree. A set of screens will open in the work space that enable the user to completely configure the selected drive:

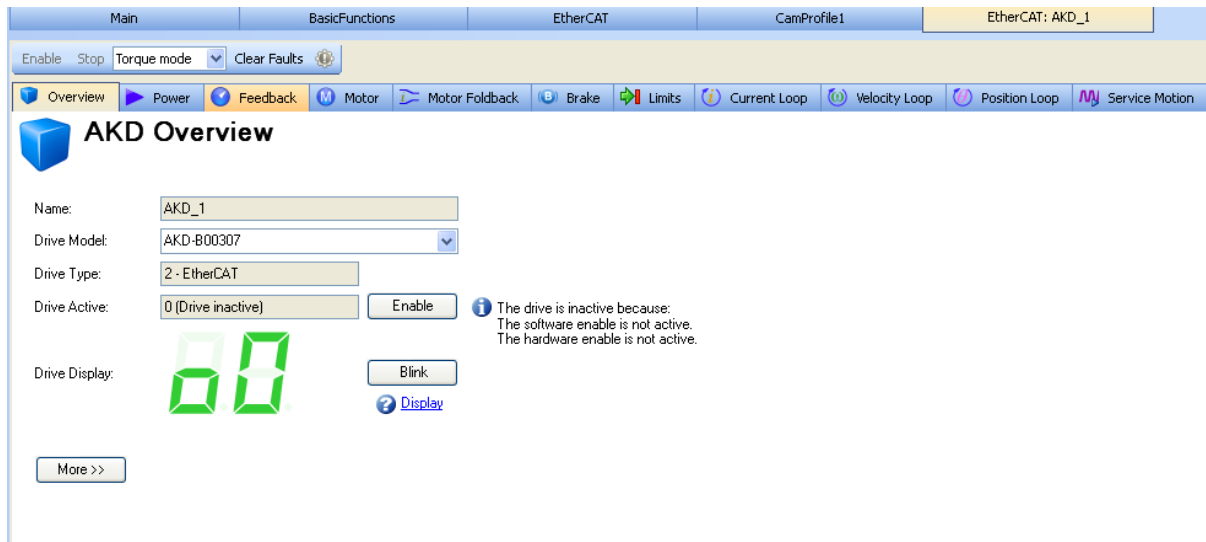

Figure 4-11: AKD PDMM GUI screens

Additionally, the setup wizard will guide you through a set of configuration steps:

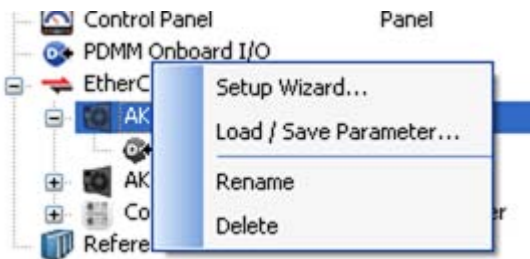

Figure 4-12: Setup Wizard

4.4 Where To Go From Here

Depending upon your need, you should either continue using this manual or use the KAS IDE web help.

- For more information about the KAS IDE embedded WorkBench views, see chapters Using Embedded Workbench Views through Using Parameters and the Terminal Screen (→ p. 165).

- For more information about programming your application and system, see the KAS IDE Online Help. The best place to start is *Using KAS IDE > Creating a Project > Steps 1 - 15*.

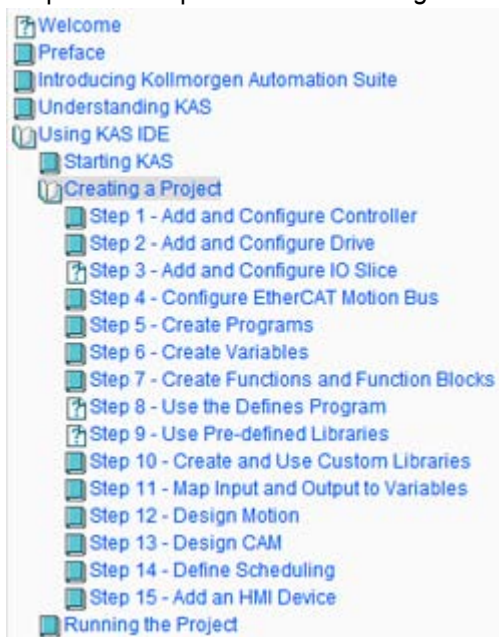

5 Initial Drive Setup

5.1 Initial Drive Setup	36
5.2 AKD PDMM Display Codes	36
5.3 AKD PDMM Setup Wizard	37
5.4 Settings	39

5.1 Initial Drive Setup

The [AKD PDMM Quick Start Guide](#) provides details for initial drive setup. Initial drive setup consists of the following general steps:

Hardware Installation:

1. Install the drive on your conductive panel and connect the Protective Earth ground.
2. Connect the logic power you will need to operate all of the control logic to X1.
3. Connect the motor power to X2.
4. Connect the feedback to X10.
5. Connect the inputs and outputs you will be using on X7 and X8.
6. Bring AC power to the unit and connect AC power to X3 or X4.
7. Connect drive communications to X11.
8. Confirm that you can communicate with the drive and that your PC is linked to the AKD PDMM.

Software Installation and Drive Communication Setup:

1. Install and start the interface software (KAS IDE).
2. Set the drive IP address using the S1 and S2 switches.
3. Configure the drive using the **Setup Wizard**.

KAS IDE System Requirements

Required Components: Microsoft .NET Framework 4.0





Supported Operating Systems:

- Windows XP
- Windows Vista
- Windows 7
- Windows 8

5.2 AKD PDMM Display Codes





During drive operation the drive display shows the following codes depending on the drive status.

Left Display (Drive LED):

Display Code	Status
	Powered on and FPGA loading. If the display is locked on this code then operational and resident FPGA images are corrupt.
	Resident loading.
	Resident completed and waiting for the operational to start.
	Normal operation, position mode, no faults.

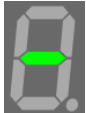
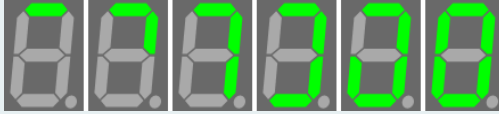
Display Code	Status
 + [3 digit code, flashing]	Fault (see Fault and Warning Messages).

Right Display (Controller LED):

Display Code	Status
	Powered on and FPGA loading. If the display is locked on this code then operational and resident FPGA images are corrupt.
	Boot sequence.
	Resident completed and waiting for the operational to start.
	Operational - program not running.
	Fault (see Fault and Warning Messages).

5.3 AKD PDMM Setup Wizard

The Setup Wizard contains step-by-step instructions for configuring a drive for the first time and generating a simple test motion. You can access the Setup Wizard from the Drive Overview screen, or by right clicking on the drive name.

1. Access the Setup Wizard by double-clicking on the drive name in the project view.

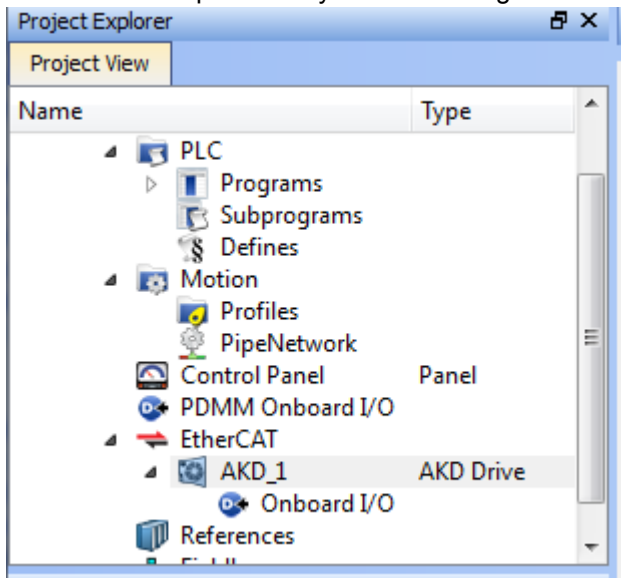

2. Enable Online Configuration mode from the toolbar, by pressing the “Toggle Online Con-



figuration Mode” button.

3. After the drive is connected, you can press the Setup Wizard button in the Drive Overview screen

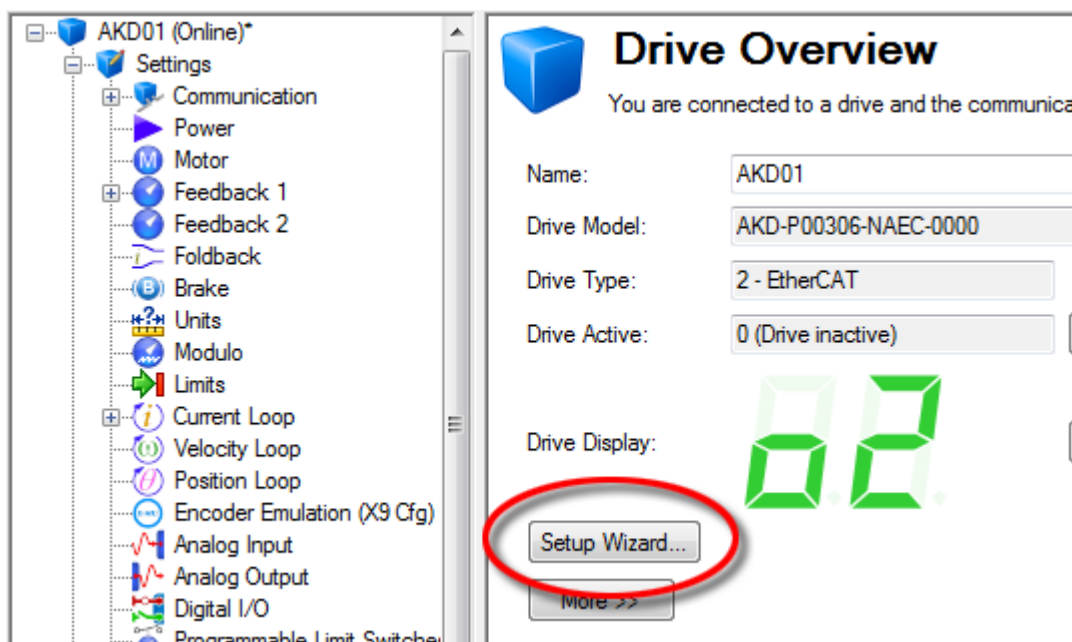

The Setup Wizard is useful during the initial setup. The wizard confirms your connection with the drive and leads you through a series of steps to quickly get your drive up and running. With plug and play feedback devices, several steps are skipped (feedback, brake) because the drive automatically configures these settings. For all systems, you can select the units you want to use, configure your operation mode, tune the system, and perform some simple jog moves within the wizard. After you are comfortable with the basic system setup, you can save your settings to the drive and exit the wizard.

5.4 Settings

5.4.1 Navigation Tree

The Settings view allows you to configure the drive to fit your specific application. When you click Settings in the navigation pane located to the left of the [EWW¹](#) screen, additional views for configuring your drive appear. By default, only settings applicable to your current drive operation mode and command source will appear in this tree. To show all settings available for the AKD PDMM (even if these settings are not used with the current operation mode and command source), right click on **Settings** and select **Show all Settings**.

5.4.2 Settings View

From the main Settings view, you can configure the following drive settings:

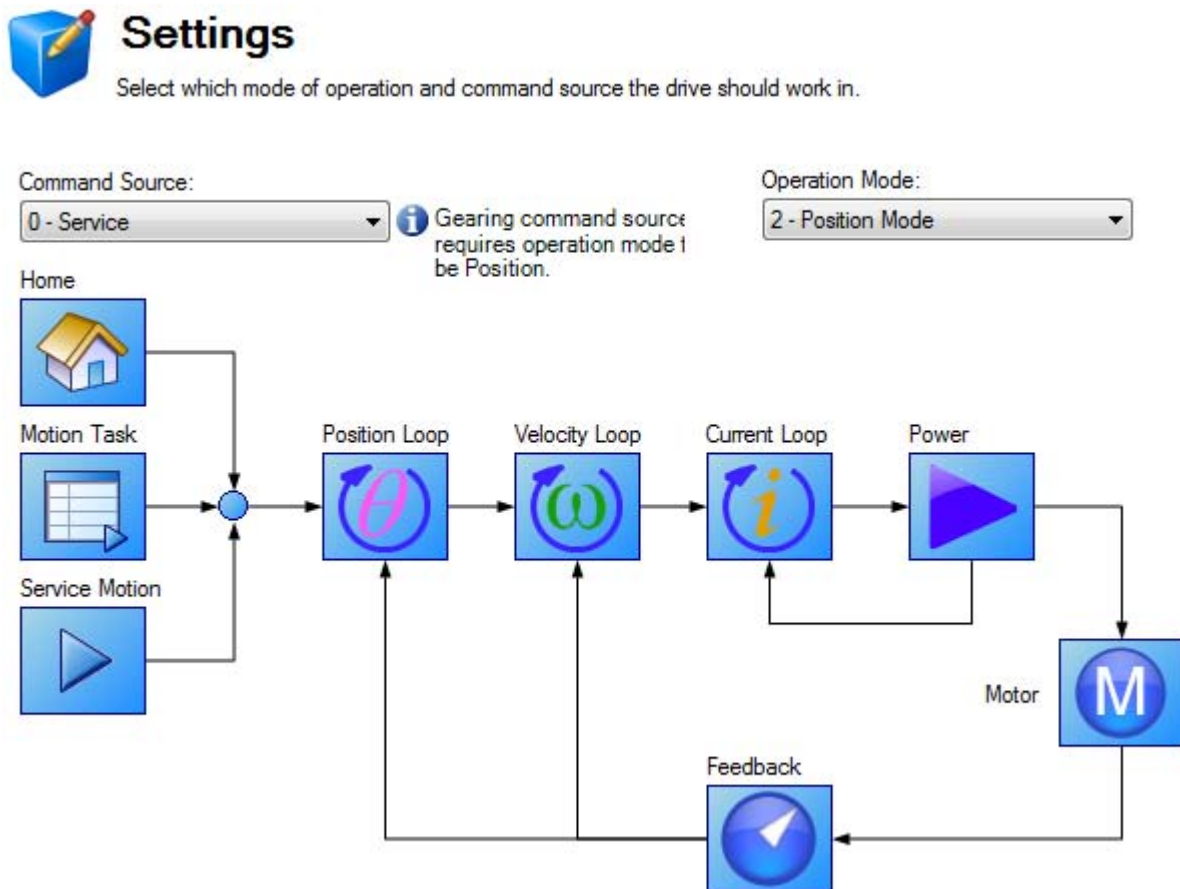

¹Embedded Workbench Views

Button or Dialog Box	Description
Command Source	<p>Selects where the command is being provided:</p> <ul style="list-style-type: none"> 0-Service: You communicate with the drive using the TCP/IP service channel. 1-Fieldbus: The drive is being controlled by commands coming over the fieldbus. 2-Gearing: The position is proportional to the secondary feedback. 3-Analog: The analog input provides a current, velocity, or position command. <p>1-Fieldbus: For normal KAS Runtime operation 0-Service : For tuning and commanding motion via the AKD PDMM setup screens</p>
Operation Mode	<p>Selects the control loop being commanded from the source:</p> <ul style="list-style-type: none"> 0-Torque Mode: Drive controls are based on the current passing through the motor. For a rotary motor, this value is proportional to the torque of the motor; for linear motors, this value is proportional to the force the motor generates. 1-Velocity Mode: Drive controls are based on the velocity of the motor. 2-Position Mode: Drive controls are based on the position of the motor.
Operation Mode	<p>Selects the servo loops that are used in the drive.</p> <ul style="list-style-type: none"> Mode 0: Current Loop (used primarily during drive setup) Mode 1: Velocity and Current Loops (used primarily during drive setup) Mode 2: Position, Velocity, and Current Loops (Default KAS Runtime mode)
Motion and Control Loop Graphics	<p>Allows you to select the details related to each specific loop from a graphical interface.</p>

Related Topics

Using Command Source and Operating Modes for details on configuring the drive for your application.

6 Configuring Drive Power

6.1 Power	42
6.2 Operating Voltage	42
6.3 Direct DC Mains Operation	42
6.4 Regeneration	44

6.1 Power

6.1.1 Drive Setup for Power and Bus

The **Power** screen allows you to confirm Power Bus settings. Review the data on the screen to be certain the bus voltage is at the appropriate levels you expect (approximate input line AC voltage * 1.4). The other values are the appropriate limits for over voltage and under voltage for the particular drive. You can select the under voltage fault mode to trigger either only when the drive is enabled or always.

External Regeneration (→ p. 44) parameters can be set from the Regen screen.

From the **Power** screen, you can view and configure the drive power settings as follows:

Button or Dialog Box	Description	Parameter
Measured Bus Voltage	Reads the current DC bus voltage.	VBUS.VALUE (→ p. 698)
Over Voltage Fault Level	Reads the over voltage fault level.	VBUS.OVFTHRESH (→ p. 692)
Under Voltage Fault Level	Reads the under voltage fault level.	VBUS.UVFTHRESH (→ p. 695)
Operating Voltage	Sets the operating voltage.	VBUS.HALFVOLT (→ p. 691)
Under Voltage Fault Mode	Sets under voltage mode.	VBUS.UVMODE (→ p. 696)

See Regeneration (→ p. 44) for more information about regen resistors and sizing regen resistors.

6.2 Operating Voltage

Operating voltage can be selected by the user to allow AKD PDMM-xxx07 (480VAC) drives to work on 240VAC input supplies.

The VBUS.HALFVOLT parameter has an effect on the following voltage-thresholds:

- DC-bus over-voltage threshold (see VBUS.OVFTHRESH (→ p. 692)).
- The regen-resistor enable/disable voltage thresholds.
- The inrush-relay enable/disable voltage thresholds.

A power-cycle is needed after changing the value and saving the parameter on the NV memory of the Drive, since the voltage thresholds mentioned above are read during the boot-sequence of the Drive.

6.3 Direct DC Mains Operation

Direct DC input is available on all standard AKD PDMM models. The DC input should be run into the AC input connection. Positive and negative DC lines should use L1 and L2 connections (polarity is not critical). L1 and L2 connections are found on either the X3 connector or the X4 connector depending on the model.

(see Mains supply connection (X3, X4) (→ p. 214) for more information on this connection).

The nominal level of DC voltage applied must be compatible with the voltage fault levels in the drive. You must also consider voltage variations in the DC power supply above and below the nominal value so that nuisance faults are avoided.

When you determine the maximum nominal DC voltage applied to the drive, you should also consider the regeneration circuit, in addition to the over voltage level. Running the drive slightly below the over voltage level is not possible because the drive does not have the capability to dissipate regenerated energy. This practice can also be harmful to the regen circuit. A good practice is not to exceed the nominal DC voltage produced by a standard AC installation.

For the AKD-Mzzzz06, 340 VDC is the equivalent DC voltage for a 240 VAC supply and for the AKD-Mxxxx07, 680 VDC is the equivalent DC voltage for a 480 VAC supply.

The voltage fault levels are also shown in the **Power** screen and depend on the voltage level of drive used.

Voltage ranges are as follows:

Model	Under Voltage Level	Over Voltage Level
AKD-Mzzz06	90 VDC	420 VDC
AKD-Mzzz07	380 VDC	840 VDC

You can view bus voltage values in the **Power** screen as shown below:



Power

Monitor and configure the different power values.

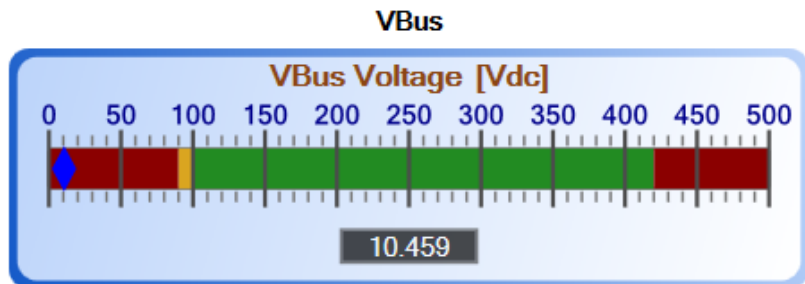

Voltage

Over Voltage Fault Level: Vdc

Under Voltage Fault Level: Vdc

Operating Voltage:

Under Voltage Fault Mode:

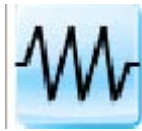

6.4 Regeneration

6.4.1 Overview

Regeneration, or "shunting", dissipates energy from the DC bus during deceleration of the motor load. During deceleration, the motor acts as a generator that pumps energy back into the system. If this energy is not dissipated, then the bus energy level can exceed acceptable levels (VBUS.OVFTHRESH (→ p. 692)). If the system exceeds the maximum bus voltage, then the drive generates an over voltage fault (F501) and shuts down. A regeneration resistor, or regen resistor, is an external device that dissipates excess energy and allows the drive to function normally during deceleration.

Follow these steps to determine the regen needs for your system and to configure the drive for regen:

1. Calculate motor peak and continuous regenerative energy and use this value to size the regen resistor.
2. Select a compatible regen resistor.
3. Configure regen parameter values in EWV¹.

From the Regen view, the following drive regen settings can be viewed and configured.

Button or Dialog Box	Description	Parameter
Regen Resistor Type	Sets the regen resistor type to either -1-External Regen or 0-Internal Regen (if available) .	REGEN.TYPE (→ p. 663)
External Regen Resistance	Sets the external, user-defined regen resistor resistance (only visible for external regen).	REGEN.REXT (→ p. 661)
External Regen Heat Up Time	Sets the external regen resistor thermal protection time constant (only visible for external regen).	REGEN.TEXT (→ p. 662)
External Regen Power	Sets the regen resistor's power fault level for an external regen resistor (only visible for external regen).	REGEN.WATTEXT (→ p. 664)
Regen Power	Reads the regen power (only visible for external regen).	REGEN.POWER (→ p. 659)

6.4.2 Regen Resistor Options

Select "-1 External Regen" from the **Regen. Resistor Type** box (REGEN.TYPE (→ p. 663)) to view the **Select Resistor** drop-down box.

Regen

Configure the regeneration resistor.

Regen. Resistor Type: -1 - External Regen

External Regen Resistance: 33 Ohm

External Regen Heat Up Time: 27.500 s

External Regen Power: 200 W

Regen. Power: 0 W

Select Resistor: BAFP-200-33

BAFP-100-33	DE-201437
BAFP-200-33	DE-201438
BAR-250-33	DE-106254
BAR-500-33	DE-106255
BAR-1500-33	DE-106258
BAS-3000-33	DE-201407
<User Defined>	

¹Embedded Workbench Views

The **Select resistor** drop-down contains pre-sized resistors for your drive. Select the model regen resistor that you are using and the drive will populate the remainder of the fields. If you are using a non-standard resistor, then choose **<User defined>** and fill in the appropriate values for your resistor.

NOTE

If you use a nonstandard resistor, contact Kollmorgen technical support to confirm that the non-standard resistor will work correctly with your system.

6.4.3 Calculating Motor Peak Energy and Regen Resistor Size

In order to determine whether or not your system requires a regen resistor, you must calculate the peak kinetic energy that the motor generates during deceleration and the continuous regeneration energy created by the motor. If this energy exceeds the drive capacity, then you need a regen resistor. In many cases, peak or continuous regenerated energy does not exceed the drive capacity and no regen resistor is needed.

The calculation for peak kinetic energy requires values for several factors that affect the generation of energy in a motion system:

- Load inertia
- Motor inertia
- Motor speed from which deceleration occurs
- Time required to decelerate

Regen resistor sizing information for your particular application can be calculated using the Motioneering® Application Engine. You can download this program here:

http://www.kollmorgen.com/website/com/eng/support/design_tools/motioneering.php

After you install and set up this program, highlight your application (1) and then click on the Power Supply Sizing icon (2).

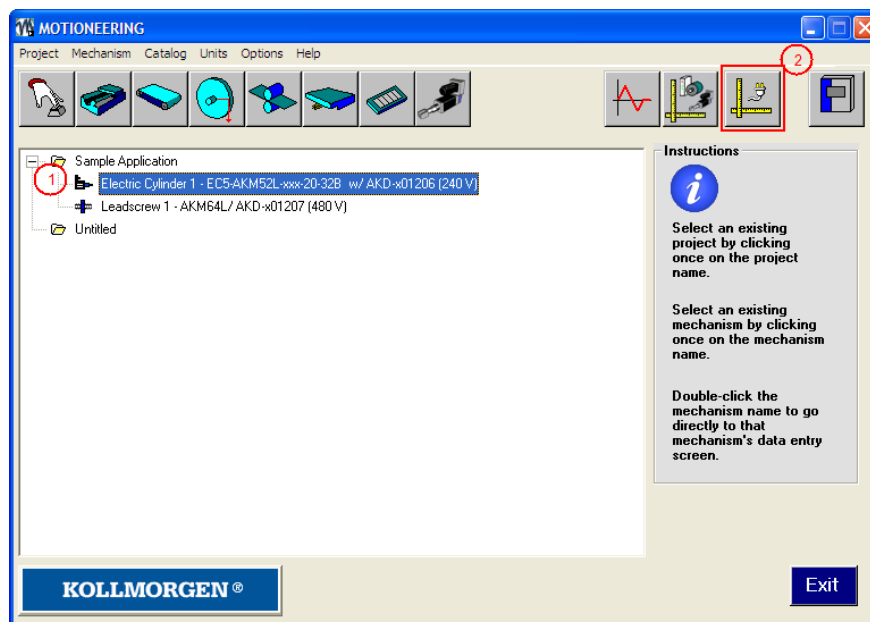

The application then displays the regen sizing tool; see the application help for further sizing assistance.

Power supply sizing

Project: Sample Application List drives of type: AKD

Mechanism	Selected system	% rated power	watts
Leadscrew 1	AKM64L / AKD-x01207 (480 V)	57.8	3050.8

Bus power

Determine by:

- Continuous mechanism load
- Mechanism with motion profile
- Estimated machine tool duty
- Maximum rated system power
- Custom

Power requirements

3050.8 Bus watts

Regeneration requirements

178.0 Regeneration watts (avg.)
198.5 Maximum resistance (ohms)
2796.5 Regeneration watts (peak)



Regeneration

Determine by:

- Simultaneous peak deceleration
20.0 % Duty cycle
- Motion profile

Instructions

 Select one or more systems by holding down control key for combined requirements. Select bus power and regeneration methods, and results will be automatically calculated.

NOTE
 Multiple servo amplifiers can be coupled via the DC bus connection and thus share the combined regeneration power.

Exit

6.4.4 Selecting a Compatible Regen Resistor

After you calculate the appropriate resistor size, compare the results with the capabilities of the drive and, if necessary, select an external regeneration resistor which matches these capabilities from the chart below. The resistors shown below are included in the KAS IDE setup. If you do not find a match for your application, please contact the Kollmorgen customer support team for further assistance.

NA Part Number	EU Part Number	Resistor Type	AKD-M0030-6	AKD-M0060-6	AKD-M0120-6	AKD-M0240-6	AKD-M0030-7	AKD-M0060-7	AKD-M0120-7	AKD-M0240-7
BAFP-100-33	DE-201437	External Resistor, 100 W, 33 ohms	x	x			x	x	x	
BAFP-200-33	DE-201438	External Resistor, 200 W, 33 ohms	x	x			x	x	x	
BAR-250-33	DE-106254	External Resistor, 250 W, 33 ohms	x	x			x	x	x	
BAR-500-33	DE-106255	External Resistor, 500 W, 33 ohms	x	x			x	x	x	
BAR-1500-33	DE-106258	External Resistor, 1500 W, 33 ohms	x	x			x	x	x	
BAS-3000-33	DE-201407	External Resistor, 3000 W, 33 ohms	x	x			x	x	x	
BAR-600-23	DE-200613	External Resistor, 600 W, 23 ohms								x

NA Part Number	EU Part Number	Resistor Type	AKD-M0030-6	AKD-M0060-6	AKD-M0120-6	AKD-M0240-6	AKD-M0030-7	AKD-M0060-7	AKD-M0120-7	AKD-M0240-7
BAR-1000-23	DE-200614	External Resistor, 1000 W, 23 ohms								x
BAS-2000-23	DE-200615	External Resistor, 2000 W, 23 ohms								x
BAS-3000-23	DE-200616	External Resistor, 3000 W, 23 ohms								x
BAS-4000-23	DE-200617	External Resistor, 4000 W, 23 ohms								x
BAR-500-15	DE-201439	External Resistor, 500 W, 15 ohms			x	x				
BAR-1000-15	DE-201440	External Resistor, 1000 W, 15 ohms			x	x				
BAS-2000-15	DE-103871	External Resistor, 2000 W, 15 ohms			x	x				
BAS-3000-15	DE-103872	External Resistor, 3000 W, 15 ohms			x	x				

NA Part Number	EU Part Number	Resistor Type	AKD-M0030-6	AKD-M0060-6	AKD-M0120-6	AKD-M0240-6	AKD-M0030-7	AKD-M0060-7	AKD-M0120-7	AKD-M0240-7
BAS-6000-15	DE-103873	External Resistor, 6000 W, 15 ohms			x	x				

6.4.5 Configuring Regen Parameter Values

If you use an external regen resistor, then you must configure three regen parameter values. These values are automatically inserted in KAS IDE if the resistor is pre-sized. The chart below summarizes these three additional values:

- **External Regen Resistance** (REGEN.REXT, ohms)
- **External Regen Heat Up Time** (REGEN.TEXT, seconds)
- **External Regen Power** (REGEN.WATTEXT, watts)

These parameters allow the regen resistor to function properly and dissipate power appropriately for your system.

NA Part Number	EU Part Number	Resistor Type (all resistors UL recognized)	Resistance ohms (REGEN.REXT)	Heat Up Time s (REGEN.TEXT)	Power Rating W (REGEN.WATTEXT)
BAFP-100-33	DE-201437	External Resistor, 100 W, 33 ohms	33	16.5	100
BAFP-200-33	DE-201438	External Resistor, 200 W, 33 ohms	33	27.5	200
BAR-250-33	DE-106254	External Resistor, 250 W, 33 ohms	33	22.0	250
BAR-500-33	DE-106255	External Resistor, 500 W, 33 ohms	33	33.0	500
BAR-1500-33	DE-106258	External Resistor, 1500 W, 33 ohms	33	25.7	1,500
BAS-3000-33	DE-201407	External Resistor, 3000 W, 33 ohms	33	77.0	3,000
BAR-600-23	DE-200613	External Resistor, 600 W, 23 ohms	23	27.5	600
BAR-1000-23	DE-200614	External Resistor, 1000 W, 23 ohms	23	27.5	1,000

NA Part Number	EU Part Number	Resistor Type (all resistors UL recognized)	Resistance ohms (REGEN.REXT)	Heat Up Time s (REGEN.TEXT)	Power Rating W (REGEN.WATTEXT)
BAS-2000-23	DE-200615	External Resistor, 2000 W, 23 ohms	23	77.0	2,000
BAS-3000-23	DE-200616	External Resistor, 3000 W, 23 ohms	23	84.3	3,000
BAS-4000-23	DE-200617	External Resistor, 4000 W, 23 ohms	23	77.0	4,000
BAR-500-15	DE-201439	External Resistor, 500 W, 15 ohms	15	33.0	500
BAR-1000-15	DE-201440	External Resistor, 1000 W, 15 ohms	15	27.5	1,000
BAS-2000-15	DE-103871	External Resistor, 2000 W, 15 ohms	15	77.0	2,000
BAS-3000-15	DE-103872	External Resistor, 3000 W, 15 ohms	15	84.3	3,000
BAS-6000-15	DE-103873	External Resistor, 6000 W, 15 ohms	15	91.7	6,000

Related Parameters

REGEN Parameters (→ p. 658)

VBUS.OVWTHRESH (→ p. 693)

VBUS.VALUE (→ p. 698)

7 Configuring Motor Settings

7.1 Motor	52
7.2 Feedback 1	56
7.3 Extended Multiturn	59
7.4 Non-Plug and Play Feedback Devices	60
7.5 Foldback	61
7.6 Brake	64
7.7 Using Position Capture	65

7.1 Motor

7.1.1 Overview

The **Motor** screen is used to set up or confirm the parameters of the motor that is connected to the drive. In certain cases, based on the feedback type, the motor parameters will automatically be set. The drive will auto-detect feedback devices that are preset with the appropriate feedback and motor parameters when MOTOR.AUTOSET is set to 1 (default). The values the drive uses for commutation and current and velocity loop gains will be populated automatically.

If your motor does not have a plug and play feedback device, then you must turn off the motor autoselect feature as shown in the screenshot below (MOTOR.AUTOSET = 0) and select the appropriate motor from the motor parameter database.

All of the appropriate Kollmorgen motors compatible with the AKD PDMM drive are contained in the motor database. For motors that are not listed, click **Select Motor** to open a custom motor view in which you can input the appropriate motor parameters.

7.1.2 Motor Setup

When motor autoselect is on (MOTOR.AUTOSET = 1), the AKD PDMM will automatically configure motor parameters from the data stored in a supported feedback device (Kollmorgen motors with SFD, Endat, BiSS, Hiperface and Hiperface DSL). If your motor is detected automatically, the parameters in the Motor view are shaded and not accessible. If you have a non-plug and play standard device (such as an incremental encoder or resolver), you can use this screen to enter the standard AKM, Cart-ridge motor, DDR, or DDL motor. Other motors can be configured from the Selecting a Motor (→ p. 53) screen.

7.1.3 Using the Motor View

The **Motor** view displays parameters related to the specific motor attached to the drive as follows:

- **Motor Name:** The motor part number read from the autoselect device, or the name from the motor database. When entering a custom motor name, the motor name should not contain any spaces.
- **Motor Type:** This field allows you to select the proper parameters for a rotary motor or a linear motor (linear motors are a future feature).
- **Motor Autoselect:** This setting to allows the drive to automatically set up a plug and play motor (MOTOR.AUTOSET = 1). With **Motor Autoselect** turned off (MOTOR.AUTOSET = 0), you can access the motor database to select a catalog or custom motor.

The next set of parameters displayed are specific to the electrical and mechanical characteristics of the motor connected to the AKD PDMM drive.

- Continuous Current: Motor continuous current rating in Amps rms (MOTOR.ICONT (→ p. 582)).
- Peak Current: Motor peak current rating in Amps rms (MOTOR.IPEAK (→ p. 589)).
- Coil Thermal Constant: Motor coil thermal time constant in mHz (MOTOR.CTF0 (→ p. 580)).
- Inductance (quad, H): Motor rated inductance in milliHenries (MOTOR.LQLL (→ p. 594)).
- Inductance (direct, H): Motor line to line direct axis inductance (MOTOR.LDLL (→ p. 592)). Only visible for MOTOR.TYPE = 6, Rotary Interior Permanent Magnet.
- Inductance Saturation: Motor quadrature axis inductance saturation characteristic (MOTOR.LISAT (→ p. 593)). Only visible for MOTOR.TYPE = 6, Rotary Interior Permanent Magnet.
- Motor Poles: Number of motor poles (MOTOR.POLES (→ p. 600)).
- Motor Phase: Motor phase offset used to set motor commutation as required. For most devices this is set to 0 (MOTOR.PHASE (→ p. 596)).
- Inertia: Motor rotor inertia in Kg-cm² (MOTOR.INERTIA (→ p. 588)).
- Torque Constant: Motor torque constant in Nm/Arms (MOTOR.KT (→ p. 591)).
- EMF Constant: Defines how much voltage is generated at the motors coils (MOTOR.KE (→ p. 590)).
- Motor Resistance: Motor winding resistance in Ohms (MOTOR.R (→ p. 601)).
- Maximum Voltage: Motor maximum rated voltage in Vrms (MOTOR.VOLTMAX (→ p. 614)).
- Maximum Speed: Motor maximum rated speed (MOTOR.VMAX (→ p. 613)).

7.1.4 Selecting a Motor

The **Select Motor** button opens a screen in which you can configure a non-plug and play motor or custom motor.

When this screen is opened, KAS IDE displays by default the motor matched to the current motor name attached to the drive. KAS IDE searches matching motor as follows:

1. KAS IDE first checks the motor name with custom motors for a match.
2. If a match is not found, then KAS IDE checks the name with the standard motors database for a match.
3. If a match is not found, then an AKM motor is selected.

For non-plug and play motors, a database of catalog motors is available based on the different Kollmorgen motor families. When you select a motor family, a part number is displayed according to the selected motor family. You can change the part number as needed, and the complete motor name will

be displayed according to your selection. This complete motor name is sent to drive. The portions of the part number labeled in bold are required values.

7.1.5 Configuring Custom Motors

From the Select Motor screen, click on **Custom Motor** to create and edit custom motors in the following screen:

Select the custom motor you wish to modify from the list and edit its individual properties on the right. [Learn more about this topic](#)

Custom Motors:

Name	Name:	Value	Unit
AKM22C	Name:	AKM22C	
	Type:	Rotary	
	Inertia:	0.160	kg cm ²
	Maximum Speed:	8000.000	RPM
	Thermal Time Constant:	6.000	s
	Torque Constant:	0.601	N m/A
	Inductance:	35.400	mH
	Continuous Current:	1.359	A
	Peak Current:	5.593	A
	Pole Pairs:	3	
	Maximum Voltage:	480	Vrms
	Coil Thermal Constant:	10.131	mHz
	Resistance:	20.000	Ohm
	Electrical Phase:	0	deg

Buttons: New... Duplicate Delete Import... Export... Apply OK

In this view, you can import or export a motor parameter file, or create a custom motor of your choice. The appropriate parameters must be chosen as listed. Several of the parameters allow you to select an alternate unit of measure. When building a custom motor file, do not use blank spaces in the name you choose. Once you have configured one or more custom motors, if you select a custom motor from the list and click **OK**, then the selected custom motor will be displayed in the **Select Motor** screen.

The actions available in the custom motor screen include:

- **New.** Allows you to start a new custom motor (with default values) or load a catalog motor you may want to modify.
- **Duplicate.** Makes a copy of the highlighted motor in the custom motor list.
- **Delete.** Deletes the highlighted motor in the customer motor list.
- **Import.** Allows you to import a motor file (*.motor) from another location
- **Export.** Allows you to save the highlighted motor file (*.motor) to another location
- **Apply.** Accepts the values you have entered for the specific motor files you are entering.
- **OK.** Returns you to the **Motor Selection** screen.

When entering any of the motor data, be certain the units are correct. The AKD PDMM drive uses the motor parameters to set up the various feedback loops and limits associated with the motor selected.

Note that if you select a custom motor from the list and click **OK**, then that selected custom motor will be displayed in the Select Motor screen.

7.1.5.1 Validating Motor Parameters

When you click **OK** in the **Select Motor** screen, KAS IDE validates the range with the drive. If any error is found, an error screen is displayed. Click **Continue** to set the motor parameters in the drive. Click **Cancel** to close this screen.

If errors occur while setting the motor parameters, an error screen indicates which parameters require additional attention.

7.1.6 Motor Derating

Motor derating occurs while using a motor in the AKM or VLM series. If a brake is selected or a feedback type other than Resolver is selected, the continuous current will be derated.

Resolver with no brake (no derate):

M Motor
 These parameters describe the motor attached to this drive.

Motor Name:

Motor Type:

Motor Autoselect:

Continuous Current: Ams

Peak Current: Ams

Select Motor

M Motor [Learn more about this topic](#)

Select the motor that is attached to the drive.

To attach a motor, first select Motor family and then Motor series.

Motor Family:

Frame/Winding: - Mount: Shaft: Connectors: Brake: Feedback:

To create new or edit existing custom motors:

SFD with no brake (derated):

M Motor
 These parameters describe the motor attached to this drive.

Motor Name: AKM11B-ACCNC-00 Select Motor...

Motor Type: 0 - Rotary, Permanent M... Create Motor...

Motor Autoset: 0 - Off

Continuous Current: Ams

Peak Current: Ams

Select Motor

M Motor
 Select the motor that is attached to the drive.

To attach a motor, first select Motor family and then Motor series.

Motor Family: AKM Series

Frame/Winding: AKM11B - Mount: A - Shaft: C - Connectors: C - Brake: N - **Feedback:**

To create new or edit existing custom motors:
Custom Motors...

Feedback:

- 1- 1024 LPR digital encoder w/commutation
- 2- 2048 LPR digital encoder w/commutation
- C- Smart feedback device (SFD)**
- R- Resolver
- GC Single-turn capacitive HIPERFACE encoder
- GD Multi-turn capacitive HIPERFACE encoder

OK Close

7.1.7 Motor Temperature

The motor temperature settings are located in the nested motor temperature view. If your motor has thermistor with linear characteristics (MOTOR.RTYPE = 2, 3, or 4), the Actual Motor Temperature field will display the value of MOTOR.TEMPC. For other values of MOTOR.RTYPE this field will be hidden.

Device Topology

- Start Page
- CN (Online)*
 - Settings
 - Communication
 - Power
 - Regen
 - M Motor**
 - Motor Temperature**
 - Feedback 1
 - Feedback 2
 - Foldback
 - Brake
 - Units
 - Modulo
 - Limits

M Motor Temperature
 Monitor the motor temperature and configure faults/warnings.

Thermal Resistor Type: 2 - KTY83-110 Thermistor

Actual Thermistor Value: Ohm

Fault Level: Ohm i 0 means no fault

Warning Level: Ohm i 0 means no warning

Actual Motor Temperature: degC

i Many motors have a thermistor embedded in their windings. The thermistor is usually connected through the feedback connector.

Related Parameters

MOTOR Parameters (→ p. 572)

7.2 Feedback 1

The Feedback view allows you to configure the primary position feedback device fitted to your motor.

When you select your feedback device from the Feedback Selection list, the appropriate feedback configuration choices appear below the dial.

7.2.1 Overview

The AKD PDMM offers a variety of feedback solutions, which allow you to optimize your system based on your specific machine needs. The table below lists the currently supported feedback types. Your motor model number will indicate the type of feedback that you have.

Kollmorgen motors with digital feedback devices (such as SFD, Endat, BiSS and Hiperface, Tamagawa) are plug and play. With these motors, all feedback and motor settings are configured automatically. Third party motors or Kollmorgen motors with non-digital feedback types require that parameters be entered manually. See Non-Plug and Play Feedback Devices (→ p. 60)).

The following table lists current support for primary and secondary feedback:

		Primary	Secondary
Resolver	Std & Multi pole	Yes	No
SFD, SFD3		Yes	No
Incremental (Digital) Encoder	With Halls and Index	Yes	No
	No Halls with Index	Yes	Yes
	No Halls with No Index	Yes	Yes
Analog Sin/Cos Encoder	With Digital Halls	Yes	No
	With Digital Halls and Analog Index	No	No
	No Halls and No Index	Yes	No
EnDAT 2.1	Single & Multi Turn	Yes	No
EnDAT 2.2	All Digital	Yes	Yes
	Analog / Digital	Yes	No
BiSS, BiSS Mode C Renishaw	All Digital (Mode C)	Yes	No
	Analog / Digital	Yes	No
Hiperface, Hiperface DSL	Analog / Digital; Single & Multi Turn	Yes	No
	All Digital	Yes	No
Halls Sensor Only	Digital	Yes	No

7.2.2 Using Feedback Options

Use the **Feedback** screen to set up your system to match the proper feedback device. By default, the drive uses the **Auto** setting to detect feedback devices. This setting allows the drive to test the feedback device to see if it is a recognized plug and play device. If the drive recognizes the device, then all the parameters for that device and motor are loaded into the drive. Both the feedback and the motor information are now present in the drive and the system is operable.

If the feedback is a non- plug and play device, then you can choose from the list of supported devices in **Feedback Selection** list and then enter the line count manually. The following sections describe each supported device available in the **Feedback Selection** list and the input information required to configure each device.

7.2.2.1 Auto

This is the default setting and is used to determine if a plug and play device is available. If a plug and play device is available, the **Auto** mode is replaced by the feedback device detected, along with the appropriate resolution settings.

7.2.2.2 None

This setting can be used if no feedback device is connected to the X10 connector. This may be the case if FB2 or FB3 is used for position or velocity control.

7.2.2.3 Incremental Encoder

The incremental encoder is a non-plug and play device. Incremental encoders are available in a variety of line counts. If you select an incremental encoder option, the encoder resolution must be entered into the **Rotary Encoder Resolution** box. The units for this field are in counts per revolution, which is post-quadrature (multiplies the lines per revolution by 4).

7.2.2.4 Sine Encoder

Sine encoders are offered with different data communication protocols. These include Endat, BiSS, Hiperface, and others. A standard sine-cosine encoder with simple analog communication is not a plug and play device. As with the incremental encoder, the line count is entered in the **Rotary Encoder Resolution** box.

7.2.2.5 Endat 2.1, Endat 2.2

These feedback device are plug and play when ordered as an option with AKM motors.

7.2.2.6 BiSS Analog

These feedback devices are plug and play when ordered as an option with AKM motors.

7.2.2.7 Hiperface, Hiperface DSL

These feedback devices are plug and play when ordered as an option with AKM motors.

7.2.2.8 Resolver

The resolver feedback option is not plug and play. When selecting the resolver option, three specific parameters are set by default for the standard AKM resolver: phase lag, transformation ratio, and feedback poles. Currently, the AKD PDMM does not support non-Kollmorgen standard resolver options.

NOTE

The resolver frequency is set to 6875Hz and cannot be adjusted.

7.2.2.9 SFD, SFD3

Smart Feedback Device (SFD) is Kollmorgen's most popular plug and play device. SFD allows for quick and easy setup from the **Auto** mode, which automatically configures the drive with the motor and feedback parameters.

7.2.2.10 Tamagawa

This feedback type is not available on models with extension type NA (AKD PDMM Models (→ p. 27)).

7.2.2.11 Halls Only

This feedback type only supports operating in Torque mode and Velocity mode.

Due to heavy quantization, large current spikes occur at hall transition points, it is advisable to tune the observer to a low frequency (like 10Hz) and set the observer gain appropriately to achieve the best operating results.

7.2.3 Wake and Shake Overview

Motors which have no way to automatically identify commutation must run Wake and Shake. Motors without Halls fall into this category, as well as motors whose hall effect sensors were manually installed, and not aligned to a motor phase of 0 degrees.

The AKD PDMM will determine if Wake and Shake is needed for safe operation based on feedback type. If needed, the drive will automatically arm Wake and Shake. If Wake and Shake does not complete, a fault will be generated. When that fault is cleared, Wake and Shake will be automatically armed again.

NOTE

If the user attempts to manually disarm Wake and Shake on an AKD PDMM which requires it, a fault will be thrown and Wake and Shake will automatically arm again.

If Wake and Shake is armed on a motor with a feedback type that does not normally require Wake and Shake, the algorithm will still execute. If Wake and Shake fails, a fault will be generated. After the faults are cleared, Wake and Shake will automatically arm again.

NOTE

If Wake and Shake has been manually armed, it can be disarmed by clicking on the "disarm" button on the Wake and Shake screen, or by executing the WS.DISARM (→ p. 739) command over telnet.

The AKD PDMM has multiple modes of completing Wake and Shake, each with different benefits for different operating conditions.

Mode 0:

Mode 0 is the fastest of the Wake and Shake methods; it executes and completes in a few seconds, and is ideal for applications that need the fastest start-up time. The tradeoff for this fast execution time is complexity in configuration. There are a lot of parameters that must be precisely tuned for this mode to operate correctly.

For more information see Using Wake and Shake Mode 0 (WS.MODE 0) (pg 1)

Mode 1:

Mode 1 is a more traditional method of completing Wake and Shake. It is also referred to as Commutation Alignment and Pole Locking. Mode 1 takes a little longer to execute than Mode 0, but is easier to configure. Only WS.IMAX (→ p. 743) (current to be applied) and WS.TSTANDSTILL (time to apply current) need to be configured. The default values work for most motors.

For more information see Using Wake and Shake Mode 1 (WS.MODE 1) (pg 1)

Mode 2:

Mode 2 is the easiest of the Wake and Shake modes. It requires no parameters to be configured. This Auto-Commutation finding algorithm can take as long as 30 seconds to complete. Measurements are taken by exciting the motor with a sine excitation as the motor phase is adjusted. After a series of data points have been taken a DFT analysis is done to determine the motor phase offset for commutation.

7.3 Extended Multiturn

If using a multiturn feedback where the machine period is not an integer divisor of the encoder period, the full turn count must be saved so that the exact position can be recovered after a power cycle. The machine period is the number of units required by the machine to complete one operational cycle. The encoder period is the maximum amount of travel measurable by the encoder. The encoder period is calculated using the following formula:

$$\text{encoder period} = 2^{\text{(number of encoder turn bits)}} \text{(units for one turn of an end system)} \text{(gear ratio)}$$

In some applications, a multiturn feedback is not enough to ensure that the position is known after a power cycle. These applications are those where:

$$\text{Machine period} \neq \text{encoder period} * N$$

In these cases, it is necessary to track and store the number of turn bits beyond the bits stored in the feedback. These bits can be stored by setting FB1.EXTENDEDMULTITURN (→ p. 440) = 1. The supported feedback types include all multiturn encoders: BiSS, EnDAT, Hiperface and Tamagawa (the algorithm requires 12 multiturn bits). If FB1.EXTENDEDMULTITURN is set to 1 on an invalid feedback type then an error will be reported.

7.4 Non-Plug and Play Feedback Devices

To set up a AKD PDMM drive with a non-plug and play feedback device (for example a resolver or an encoder), you must select a motor from the list of standard or custom motors or enter the motor parameters manually. Once the motor data is entered into KAS IDE, an initial set of parameters can be calculated and downloaded to the drive.

7.4.1 Parameters

The following parameters can be initialized to their default values or calculated from user-supplied motor data:

IL.KP	IL.LIMITN	VL.KP	PL.KI = 0 (Default Value)
IL.KFFACC	IL.LIMITP	VL.KI	PL.INTINMAX = 0.419 (Default Value)
IL.KBUSFF	IL.PWMFREQ	VL.LIMITN	PL.INTOUTMAX = 0.419 (Default Value)
IL.FRICTION	IL.KVFF	VL.LIMITP	MOTOR.IPEAK
IL.OFFSET	IL.FOLDFTHRESHU	VL.THRESH	MOTOR.ICONT
IL.INTEN	IL.FOLDWTHRESH	VL.KVFF	MOTOR.PITCH
IL.IVFB	IL.MFOLDD	PL.KP	MOTOR.POLES
IL.KPDRATIO	IL.MFOLDT	PL.KD = 0 (Default Value)	MOTOR.TYPE

7.4.2 Calculations

KAS IDE uses the following equations to calculate parameter values.

Current Loop

The current loop proportional gain (IL.KP) must be such that the current loop closed loop crossover frequency/bandwidth (BW) nominal is the lesser of 2000 Hz or (PWM Frequency/4).

Then, with this frequency:

$$\text{IL.KP} = 2 * \pi * (\text{desired bandwidth in Hz}) * (\text{motor L line-line in H})$$

Setting the D and Q components

Velocity Loop

$$\text{VL.KP} = (2 * \pi * 75) * (2 * J_m / K_t) = 300 * \pi * J_m / K_t$$

$$\text{VL.KI} = 5$$

Slider Tuning

The slider tuning algorithm in KAS IDE currently uses the following algorithm.

Input - Motor Data

The values for inertia, J_m (Kg / cm²), and torque constant, K_t (Nm/A), are obtained from either the SFD or the motor model number that you select.

Constants

Velocity Loop Bandwidth – BW = The default value is 75Hz.

Input - Inertia Ratio – Q = The default is 1.

Output - Control Loop Gains

$VL.KP = 2 * \pi * BW * J_m * (1+Q) * 0.0001/K_t$

$VL.KPI = BW * 0.08^{-1}$ (minimum of 1)

$PL.KP = BW/5$

7.5 Foldback

The foldback feature in the AKD PDMM protects both the motor and the drive from overheating. Two current foldback algorithms run in parallel in the drive: the drive foldback algorithm and the motor foldback algorithm. Each algorithm uses different sets of parameters. Each algorithm has its own foldback current limit, IL.DIFOLD (drive foldback) and IL.MIFOLD (motor foldback). The overall foldback current limit is the minimum of the two at any given moment.

$IL.IFOLD = \min(IL.DIFOLD, IL.MIFOLD)$.

Foldback is not the same as current limits. Instantaneous current limits for the drive are set by the positive peak current (IL.LIMITP) and negative peak current (IL.LIMITN) in the Limits view in [EWV](#)¹. The foldback algorithms may reduce the current output to the motor in spite of the current limit settings.

7.5.1 Drive Foldback

The drive foldback algorithm monitors current feedback; since this is a monitoring function, the drive foldback parameters are not user configurable. If the current feedback exceeds the continuous current rating of the drive (DRV.ICONT), then the algorithm decreases the current to the DRV.ICONT level. For example, under a step command input condition, the foldback algorithm allows maximum peak current (DRV.IPEAK) output from the drive for a short period of time (up to IL.DFOLDD time), after which the drive begins an exponential foldback (with time constant of IL.DFOLDT) of the current to the drive's continuous current.

It takes a few seconds for the exponential decay to drop from the drive's peak current to its continuous level. A recovery time, when the feedback current is below DRV.ICONT level, is required to allow current above DRV.ICONT level again. A recovery time of IL.DFOLDR with 0 current allows the drive to apply DRV.IPEAK current for IL.DFOLDD time.

7.5.2 Setting up motor foldback

Motor foldback is set up automatically when using a plug and play motor or when a particular motor is selected from the EWV database.

If you are using a custom motor, use the Motor view in EWV to set custom values needed for foldback configuration. The parameter entries required for the drive to apply motor foldback protection properly are coil thermal constant (MOTOR.CTFO), peak current of the motor (MOTOR.IPEAK), and

¹Embedded Workbench Views

continuous current of the motor (MOTOR.ICONT). These values are used to setup the algorithm for motor foldback.

7.5.3 Setting Fault and Warning Levels

The **Motor Current Limit** and **Overall Current Limit** boxes show status variables that are constantly updated by the foldback algorithm. As current is applied above the drive or motor continuous rating, the capacity for the application of peak current starts to decrease. The motor current limit and overall current limit are actively decreased. If the move profile requires less than continuous current rating for a period of time, the Motor Current Limit and Overall Current Limit begin to increase until they reach maximum foldback capacity once again.

When Motor Current Limit or Overall Current Limit < Warning Level, an n524 status warning is triggered. When Motor Current Limit or Overall Current Limit < Fault Level, an F524 fault is triggered and the drive power stage is disabled. The load then coasts to a stop.

In the **Foldback** screen, setting the Warning Level to 0 turns off the warning feature. Otherwise, the Warning Level must be set above the Fault Level, but below the Motor Current Limit and Overall Current Limit to trigger a warning.

Motor Current Limit:	<input type="text" value="16.508"/>	Ams	Fault Level:	<input type="text" value="9.000"/>	Ams
Overall Current Limit:	<input type="text" value="16.508"/>	Ams	User Fault Level:	<input type="text" value="9.000"/>	Ams
Current Command:	<input type="text" value="0.000"/>	Ams	Warning Level:	<input type="text" value="0.000"/>	Ams

If User Fault Level is set above Fault Level, the User Fault Level will be ignored. The User Fault Level is used to increase the time the drive is operated in foldback mode without faulting. For instance if the default Fault Level is 9.000 Arms and a User Fault Level is set to 7.5 Arms, the Fault Level is changed to 7.5 Arms. This configuration effectively increases the time that foldback will be applied to the drive before faulting.

Motor Current Limit:	<input type="text" value="16.508"/>	Ams	Fault Level:	<input type="text" value="7.500"/>	Ams
Overall Current Limit:	<input type="text" value="16.508"/>	Ams	User Fault Level:	<input type="text" value="7.500"/>	Ams
Current Command:	<input type="text" value="0.000"/>	Ams	Warning Level:	<input type="text" value="0.000"/>	Ams

7.5.4 Motor Peak Current Time

Peak current (MOTOR.IPEAK) along with coil thermal constant (MOTOR.CTFO) are used to determine the maximum time the motor can sustain peak current. The maximum time (IL.MFOLDD) is displayed in the **Foldback** screen as shown below:

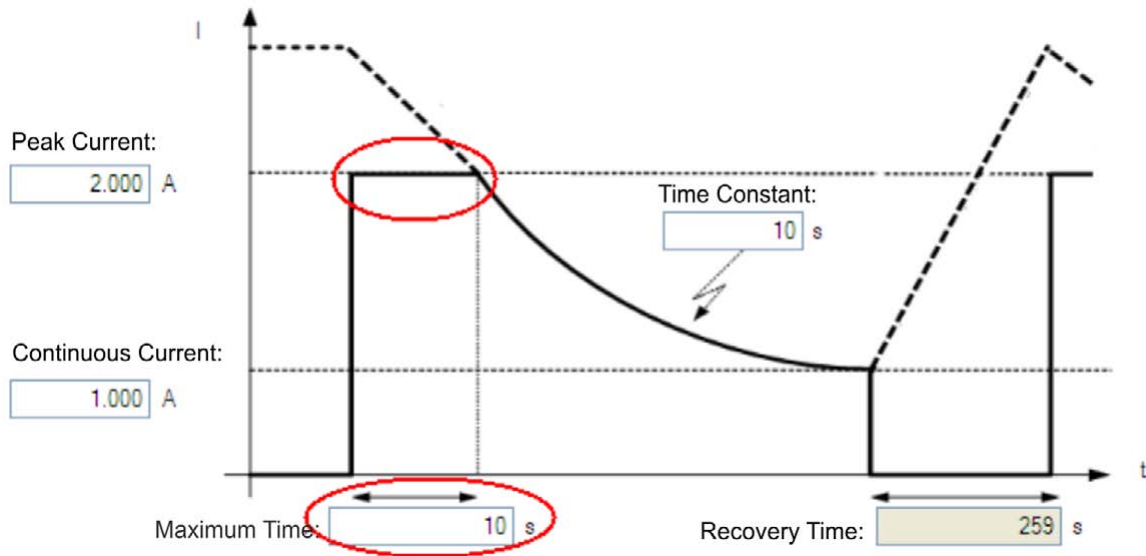

7.5.5 Motor Foldback Ramp

Once the maximum time for motor peak current has elapsed, if the move profile still demands peak current from AKD PDMM, the drive will exponentially lower the current applied to the motor. The Time Constant (IL.MFOLDT) dictates the profile. A smaller time constant represents a steeper decline in current applied to the motor.

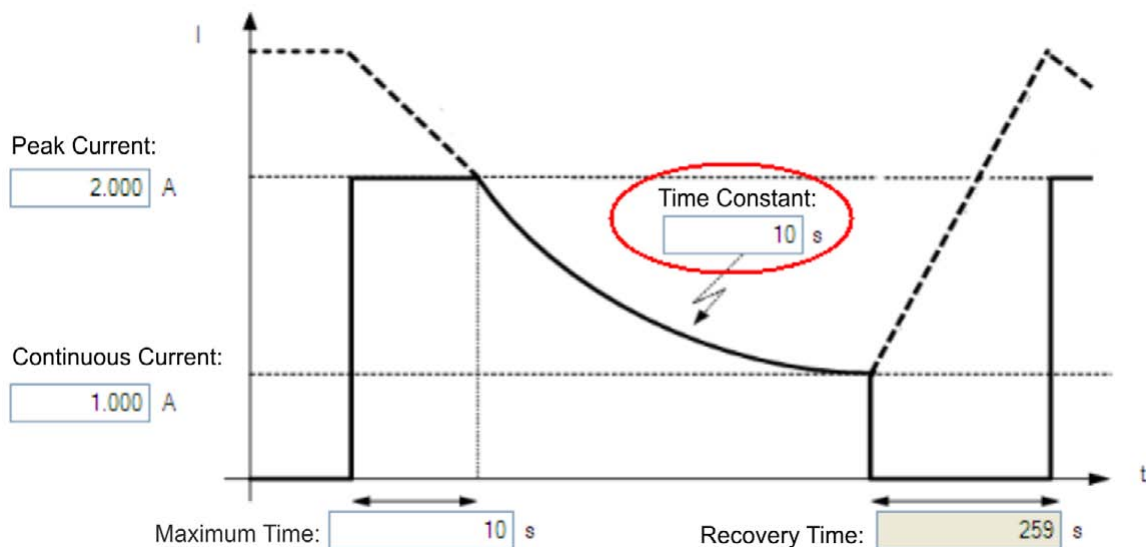

7.5.6 Motor Recovery

Once the peak motor current available has reached the continuous current of the motor, the motor needs Recovery Time (IL.MFOLDR) to cool down. Full Recovery Time (IL.MFOLDR) at 0 current is required for the motor to reach full maximum capacity in the shortest amount of time. The drive can command a current less than continuous current to continue driving the load, but the recovery time for full maximum capacity is increased.

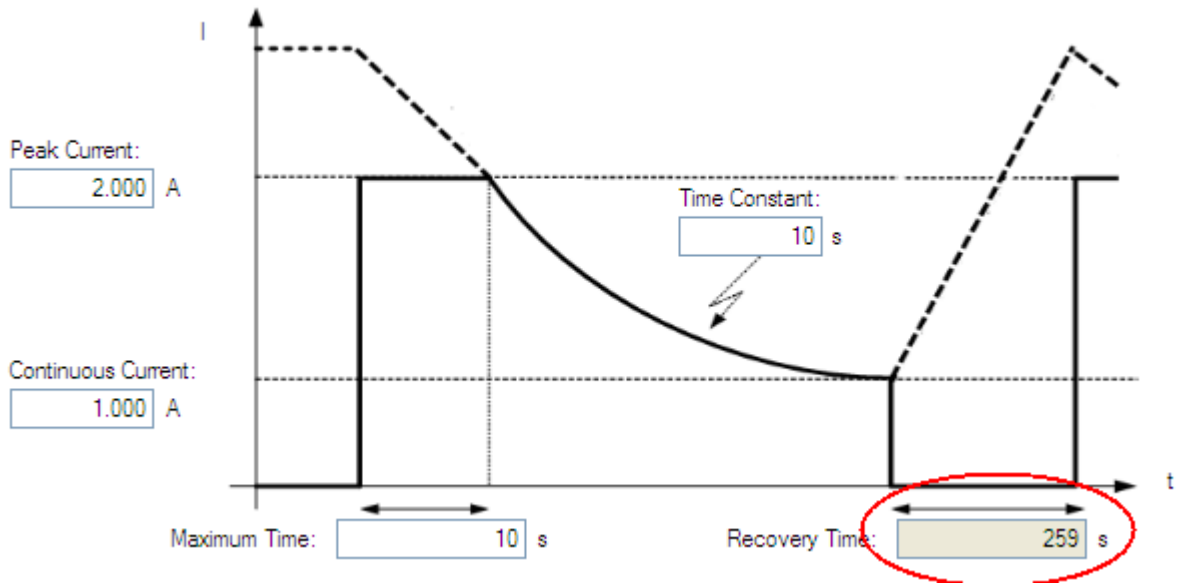

7.5.7 Overall Foldback

The overall limit is the momentary minimum value between the drive foldback and the motor foldback. The overall foldback is shown in the diagram below. You can set the warning and the fault levels as shown in the diagram.

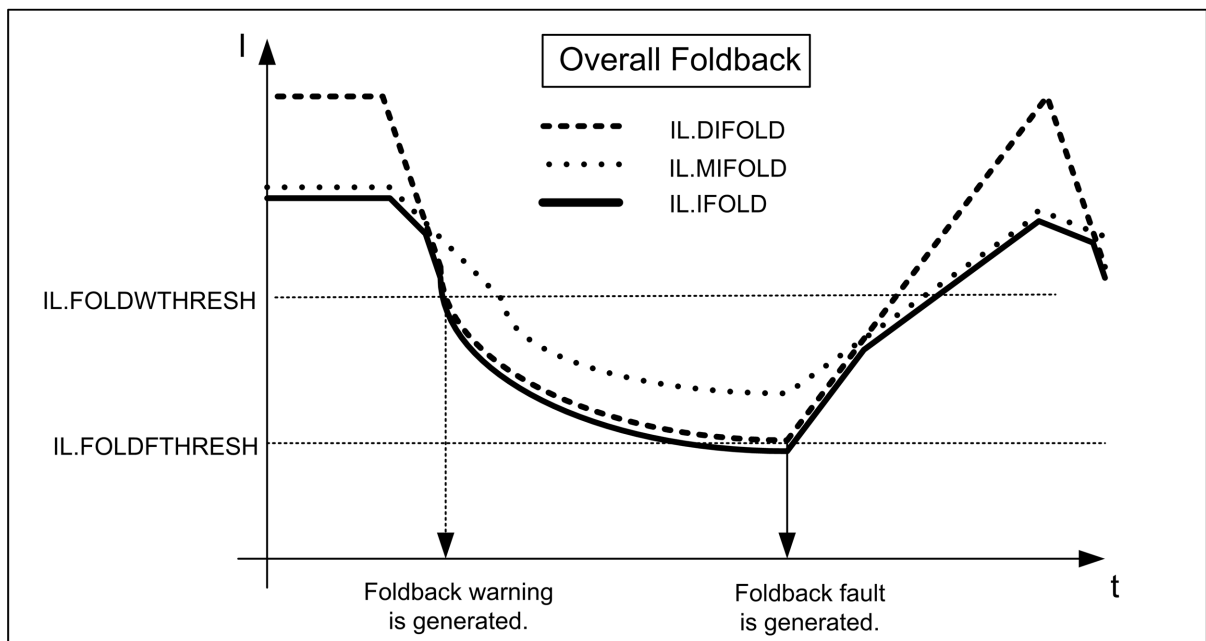

7.6 Brake

The brake output on connector X2 controls a mechanical brake that optionally may be fitted to a motor. The brake is applied and released relative to the **Drive Active** state of the drive. You can modify the release and apply delays using the parameters shown below.

Button or Dialog Box	Description	Parameter
Brake ControlState	Sets whether the motor has a brake.	MOTOR.BRAKE
Time to Release	The time, set by the user, required to mechanically disengage the brake. After this time, motion commands are accepted.	MOTOR.TBRAKERLS
Time to Apply	The time, set by the user, required to mechanically engage the brake. After this time, the drive will disable.	MOTOR.TBRAKEAPP

7.7 Using Position Capture

7.7.1 Overview

Position capture allows you to precisely determine what the motor position (or drive clock time) was when a specific event triggers. The AKD PDMM drive uses two independent captures, which operate similarly.

Position capture is used in precision environments, where the motor may be moving at very high velocities, an IO is triggered, and you must know exactly where the motor was when the event occurred. Homing algorithms often use position capture.

Position capture will capture the motor position (or drive clock time) when the capture trigger is activated. The position capture or drive lock time capture will happen in less than 3 microseconds of the input transition. This assumes the use of high speed input 1 or 2 with the filter turned off. The capture engine can be re-armed and ready for another capture in less than 62.6 microseconds. This capture engine allows the position capture to obtain more accurate results than those obtained using the scope or recorder clock.

7.7.2 Configuring Position Capture

To configure the position capture, select **Position Capture** from the **Settings** group:

PC

Position Capture

The drive will be able to capture the position of the axes

Position Capture 0

Capture Mode: 0 - Single-shot Position

Capture FB Source: 3 - Standard position

Arm

Captured Value: 0.000 deg

Capture Parameters

Source: 0 - DIN 1

Edge: 1 - Rising Edge

Pre Condition

Condition: 0 - Trigger edge (ignore precc

Source: 0 - DIN 1

Edge: 1 - Rising Edge

Position Capture 1

Capture Mode: 4 - Auto-armed position

Capture FB Source: 3 - Standard position

Armed

Captured Value: 0.000 deg

Capture Parameters

Source: 0 - DIN 1

Edge: 1 - Rising Edge

Pre Condition

Condition: 0 - Trigger edge (ignore precc

Source: 0 - DIN 1

Edge: 1 - Rising Edge

Setting the Capture Source (CAP0.FBSOURCE, CAP1.FBSOURCE (pg 1))

CAP0.FBSOURCE and CAP1.FBSOURCE select the source of the captured value. Data for all source values is retrieved with CAP0.PLFB, CAP1.PLFB (pg 1).

Value	Description
0	Captures from feedback 1 (FB1), independent of the value of PL.FBSOURCE. The units are the same as those used for PL.FB.
1	Captures from feedback 2 (FB2).
2	Captures from feedback 3 (FB3).
3	Standard position capture, which stores PL.FB (→ p. 625). The feedback number is determined by PL.FBSOURCE (→ p. 626).
4	Captures from EXTENCODER.POSITION (AKD BASIC drives only).

Setting the Trigger Source (CAP0.TRIGGER, CAP1.TRIGGER (pg 1))

The trigger source determines which input on the drive causes the position capture to trigger.

Option	Description
0 - 6	These options trigger on the Digital Input 1 pin through Digital Input 7 pin, respectively.
7 - 9	These options trigger on the X9 connector RS485 Input 1 pin through RS485 Input 3 pin, respectively.
10	This option triggers on the primary encoder index.

Setting the Capture Mode (CAP0.MODE, CAP1.MODE)

The capture mode determines what information is saved on the drive when the capture triggers.

Option	Description
0 – Standard Position	Captures the motor position in drive units.
1 – Drive Internal Time	Captures the time of the trigger in ns.
2 – Distributed Clock Time	Captures the network (Ethercat) distributed clock time.
3 – Primary Encoder Signal	Captures the motor position triggering on primary encoder index. This mode automatically rearms after each trigger.

If either **0 - Standard Position** or **3 - Primary Encoder Signal** is selected, delays may occur and are associated with feedback devices that are digital or interpolated .

Arming and Retrieving the Capture Value (CAP0.T, CAP1.T)

CAP0.EN arms the capture and CAP0.T retrieves the capture value. Once you have configured the capture, you must arm it before it will trigger. Click **Arm** (1) to arm the capture.

Once the capture is armed, when it triggers, the captured value will be displayed below the Arm button (2).

Setting the Capture Edge (CAP0.EDGE, CAP1.EDGE)

The capture edge determines which input state change triggers the capture.

Option	Description
1 – Rising Edge	Captures when the input signal goes high, from a low state.
2 – Falling Edge	Captures when the input signal goes low, from a high state.

Option	Description
3 – Both Edges	Captures any time the input signal changes state.

Setting the Pre-Condition Event: (CAP0.EVENT, CAP1.EVENT)

The Capture Pre-Condition Event gives the user more flexibility in setting what conditions must be present for the Capture to trigger.

Event Option	Description
0 – No precondition	Capture triggers as soon as the capture edge occurs.
1 – Trigger Edge after precondition	Captures triggers only when the precondition occurs before the capture edge occurs.
2 – Trigger Edge while precondition = 1	Captures triggers only while the precondition is evaluated and is true while the capture edge occurs.
3 – Trigger Edge while precondition = 0	Captures triggers only while the precondition is evaluated and is false while the capture edge occurs.

Setting up a Pre-Condition for complex capture

Setting the Precondition Edge: (CAP0.PREEDGE, CAP1.PREEDGE)

The pre-edge determines what input state change triggers the precondition. This feature operates the same as the capture edge described above.

Setting the Pre-Condition Select: (CAP0.PRESELECT, CAP1.PRESELECT)

The preselect chooses what input source will trigger the precondition (based on the preedge setting, and the prefilter setting). This feature operates the same as the capture source described above.

7.7.3 Kollmorgen Test Reports

Position Capture test report based on performance testing by Kollmorgen:

Capture Accuracy with External Sensor

Drive: AKD PDMM-T00306-NBAN-000

Motor: AKM-21C

Feedback Type: Incremental type 2048 line encoder

Digital Input used: DIN1 (high speed input)

DIN1.FILTER = 0 (very important to set this to zero so filtering does not delay the system response)

Sensor Used : IDC RP1 type mounted directly to the shaft. Common industrial limit switch.

MOVE.RUNSPEED = 1000 RPM

With the motor running at above speed and the capture mechanism armed, the drive was able to capture the position within 30-70 counts (.17 - .40 degree) of accuracy or 27.5 - 64.0 micro sec.

Capture Accuracy with Internal Index from encoder

Drive - AKD PDMM-T00606-NBAN-000

Motor-AKM22G

Feedback Type - Incremental Encoder 2048 lines

MOVE.RUNSPEED = 1000 RPM

With the motor running at above speed and the capture mechanism armed, the drive was able to capture the position within 10-20 counts (.05 - .11 degree) of accuracy or 9.5 - 18.0 micro sec.

Related Parameters

CAP Parameters (pg 1)

8 Using AKD PDMM in a Vertical Axis

NOTE

For firmware versions 1-06 and later.

The drive should be configured to execute a controlled stop action in the event of a disable command (DRV.DISMODE = 2 or 3). This allows the motor to stop and the brake to be applied before the drive stops holding up the axis and removes power. With a vertical axis application where the motor is equipped with a brake that is controlled by AKD PDMM, it is recommended to set up the axis to immediately apply the brake in the event of the power stage disabling for any reason. By setting MOTOR.BRAKEIMM (→ p. 577) = 1 (default is 0=off) the brake will apply immediately when the power stage is disabled.

The power stage can disable as a result of:

- Hardware Enable removed
- Software Enable removed
- Safe Torque Off (STO) activated
- Fault Condition
- Controlled Stop Input – any input configured as (DINx.MODE = 13 controlled stop)

If the vertical axis is stationary and disabled, toggling the brake with MOTOR.BRAKERLS (→ p. 578) will not reapply the brake until controlled stop conditions are met (the axis actual velocity has been less than CS.VTHRESH (→ p. 317) for CS.TO (→ p. 316) milliseconds). In order for the brake to reapply immediately when commanding MOTOR.BRAKERLS, set CS.VTHRESH to a value greater than the velocity possible by the free falling axis and set CS.TO to 1 millisecond (its minimum value) prior to making the command.

NOTE

For a digital input initiated controlled stop (A fault that results in controlled stop. See Fault and Warning Messages (→ p. 174)), or a software disable that is configured for a controlled stop (see DRV.DISMODE (→ p. 372)), the brake will be applied at the end of the controlled stop when the power stage disables.

It is still important to setup the brake delays. This can be done in the brake screen in EWV¹. These brake delays are used to delay the disabling of the power stage when motion is stopped and the drive is disabled. This is only pertinent for Controlled Stop and Software Disable of the drive. This prevents a slight drop of the load between the disable and the brake engagement. In other cases, (Fault, Hardware Enable, STO) hardware disconnection prevents the AKD PDMM from delaying the disable.

There is an advanced setting for the Hardware Disable. A programmable delay is available on the HW Enable input so the drive can hold the load before the disable. With a vertical load some movement could occur when the drive is disabled with a hardware input because the power stage was disabled immediately, before the brake could apply. DRV.HWENDELAY (→ p. 396) is available which will delay the disabling of the power stage. During this delay time, the drive will apply the brake immediately and simultaneously attempt to follow normal disable procedures. The value is limited to a maximum of 167 ms. During this time, the drive will attempt to bring the load velocity to 0 RPM. If DRV.HWENDELAY = 0, the feature is off (this is default).

¹Embedded Workbench Views

Vertical Application Desired Response	Customer Disable Condition	Configuration Needed	Parameter Settings Needed
Controlled stop when possible. If not possible, apply motor brake immediately.	Normal disable	Command CS using input. Do not disable power stage or command other disables until CS completes.	DRV.DISMODE = 2. Controlled stop then disable. Set: DRV.DISTO , CS.VTHRESH , CS.DEC , CS.TO .
	E-stop, or safety condition		
	Fault CS	Do not disable power stage or command other disables until CS completes.	
	Fault Dynamic Brake	N/A	N/A
	Fault Power stage disable	None	MOTOR.BRAKEIMM = 1
Controlled stop when possible. If not possible, dynamic brake.	Normal disable	Command CS using input. Do not disable power stage or command other disables until CS completes.	DRV.DISMODE = 3. Controlled stop, then dynamic brake. Set: DRV.DISTO , CS.VTHRESH , CS.DEC , CS.TO .
	E-stop, or safety condition		
	Fault CS	Do not disable power stage or command other disables until CS completes.	
	Fault Dynamic Brake	N/A	N/A
	Fault Power stage disable	None	MOTOR.BRAKEIMM = 1

9 Configuring with Linear Motors

9.1 Connecting a DDL Motor to an AKD PDMM Drive

Before Connecting a DDL motor to an AKD PDMM drive, the following tasks must be accomplished:

- Integrate motor coil and magnet way onto a bearing structure so that the motor moves freely (rubber stops at the end of travel are recommended, especially during commissioning).
- Linear scale is integrated to the assembly and set up with the correct alignment and air-gap to provide an appropriate sinusoidal or digital feedback signal.
- Determine the resolution of the Linear Scale in micrometers (microns) per cycle (this will be listed in the documentation of the linear scale).

Connect Hall sensor, Linear Scale, and motor temperature cables through the ACI-AKD PDMM cable assembly to the AKD PDMM's X10 Feedback Connector.

Connect the motor power leads to the AKD PDMM motor power connector X2 with the following connections:

Red -> U

White -> V

Black -> W

Yellow / Green -> PE

Apply 24 volt logic power to the AKD PDMM and launch KAS IDE from a computer to interface with the AKD PDMM drive. From the Motor view in [EWV¹](#), click Select Motor.



Motor

These parameters describe the motor attached to this drive.

Motor Name:	<input type="text" value="AKM22C-ACMNC-00"/>	<input type="button" value="Select Motor..."/>
Motor Type:	<input type="text" value="0 - Rotary"/>	<input type="button" value="Create Motor..."/>
Motor Autaset:	<input type="text" value="0 - Off"/>	

NOTE

If "Select Motor" is grayed out, Motor Autaset may need to be set to "0 -Off" to enable the Select Motor option.

On the Select Motor screen, for Motor Family select either **IC and ICD Series Ironcore DDL** or **IL Series Ironless DDL**. On the Select Motor screen for "Name" select the appropriate motor part number.

¹Embedded Workbench Views

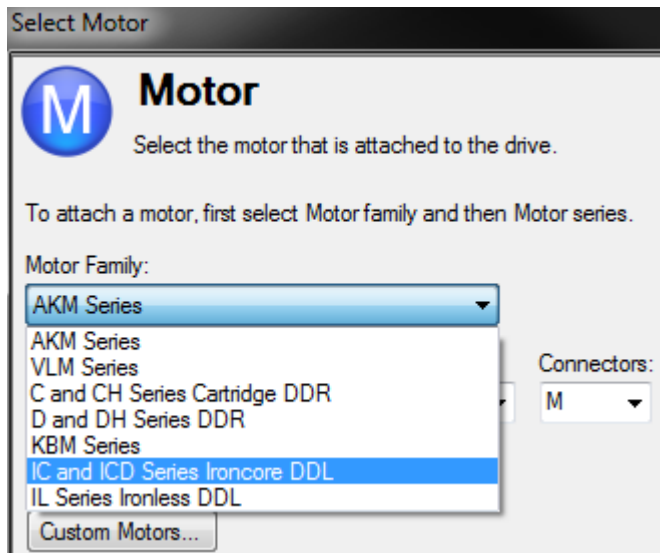

Click OK.

From the main tree, under Settings, select **Feedback 1**.

Under Feedback Selection, select either **10 – Incremental Encoder with Halls**, or **20 – Sine Encoder with Halls** to correspond to the Linear Scale that is integrated with the motor.

Feedback 1 (X10)

The primary position feedback fitted to your motor.

Feedback Selection:

Feedback Identified:

If you rotate the motor shaft you should see the dial move.

Motor Autoset:

Position Feedback:

Drive Direction:

Position Feedback Poles:

Counts 16Bit

-1 - Auto Identify

-1 - Auto Identify

10 - Incremental Encoder with Halls

11 - Incremental Encoder without Halls

20 - Sine Encoder with Halls

21 - Sine Encoder without Halls

30 - Endat 2.1

31 - Endat 2.2

32 - BiSS Analog

33 - Hiperface

34 - BiSS Mode C Renishaw

40 - Resolver

41 - SFD (Smart Feedback Device)

42 - Tamagawa Serial

43 - Network Cyclic Feedback

44 - Network Cyclic Feedback via FB2

50 - Reserved (do not use)

63 - Simulated Motor

[Goto Wake And Shake Configuration](#)

Using the resolution of the Linear Scale in Microns per cycle, the Sine Cycles/Magnet Pitch is determined. Use the following:

1. Take the reciprocal of resolution to get cycles per micron
2. Multiply by 1000 to get cycles per millimeter
3. Multiply by 32 millimeters per Magnet Pitch to get Sine Cycles/Magnet Pitch

For example, if the resolution of the Linear Scale is 40 microns per cycle, then the Sine Cycles/Magnet Pitch would be 800.

The Linear Scale phase direction must be verified. Watch the Feedback 1 screen in EWW. When the coil assembly is moved in the direction of the cable exit (think of pulling the coil by the cable), the Position Feedback should increase positively in value and in the motor graphic, the gray block should move to the right. If the direction is opposite, then the A+ and A- signals on the Linear Scale must be swapped to correct the phase direction.

The motor is now ready for velocity loop and position loop compensation.

10 Configuring General Drive Settings

10.1 Limits	75
10.2 Compare Engines	76
10.3 Enable/Disable	78
10.4 Controlled Stop	81
10.5 Dynamic Braking	83
10.6 Emergency Stop	84
10.7 Under Voltage Fault Behavior	86

10.1 Limits

This screen allows you view and modify the various drive limits.

Button or Dialog Box	Description	Parameter
Current Limits		
Positive Peak Current	The maximum positive current allowed.	IL.LIMITP (→ p. 552)
Negative Peak Current	The maximum negative current allowed.	IL.LIMITN (→ p. 551)
Dynamic Break Peak Current	The maximum amplitude of the current for dynamic braking.	DRV.DBILIMIT (→ p. 365)
Velocity Limits		
Positive Speed Limit	The maximum speed allowed in the positive direction.	VL.LIMITP (→ p. 726)
Negative Speed Limit	The maximum speed allowed in the negative direction.	VL.LIMITN (→ p. 724)
User Over Speed Limit	The user set threshold velocity for an over speed fault.	VL.THRESH (→ p. 731)
Overall Over Speed Limit	The overall over speed fault threshold.	VL.VFTHRESH (→ p. 733)
Position Limits		
Maximum Position Error	The maximum position error. If the position error PL.ERR is larger than PL.ERRFTHRESH, then the drive generates a fault	PL.ERRFTHRESH (→ p. 621)
Position Limit 0	The minimum position the drive can reach before generating a negative software position fault.	SWLS.LIMIT0 (→ p. 682)
Position Limit 1	The maximum position the drive can reach before generating a positive software position fault.	SWLS.LIMIT1 (→ p. 683)
Acceleration Limits		
Acceleration	The acceleration ramp used to profile some types of motion.	DRV.ACC (→ p. 354)
Deceleration	The deceleration ramp used to profile some types of motion.	DRV.DEC (→ p. 366)
Motor Limits	Motor limits are set through the Motor Foldback Screen (see Foldback (→ p. 61))	

10.1.1 Limits

The limits screen covers most of the basic system limits, including current, velocity, and position.

- **Current Limits:** The current limits are set based on the drive ratings. You can change these limits to be lower than the default values for the drive, however, this may effect the expected

performance of your application.

- **Velocity Limits:** The velocity limits are set based on the motor ratings. You can modify these settings above the ratings of the motor if the application requires some overhead, but be aware the motor has mechanical limitations and may be damaged if run above those limits. It is best to leave these at the default ratings for the motor selected.
- **Position Limits:** The position limits can be set based on your specific machine application requirements. The Maximum Position Error can be set to cause a fault when the position error exceeds the value you insert here. Each limit switch can be either the lower or the upper software limit switch register, depending on the value of SWLS.EN. If only one limit switch is enabled (SWLS.EN = 1 or 2), then SWLS.LIMIT0 is the lower limit, and SWLS.LIMIT1 is the upper limit. If both limit switches are enabled (SWLS.EN = 3), then whichever switch is set to a larger value is the upper limit switch. The other switch becomes the lower limit switch. As the motor reaches the lower limit, the motor will stop and display the warning n107. As the motor reaches the upper limit, the motor will stop and display the warning n108.
- **Acceleration Limits:** This field allows you to raise accelerations to give the system crisp moves. These limits default to a low value, so you may wish to change these after the mechanics and other sections of your system are defined.

10.2 Compare Engines

The AKD PDMM Position Compare feature allows the drive's digital outputs to be turned on or off depending on one or more feedback positions. The AKD PDMM supports two independent compare engines (CMP0, CMP1). The comparison is done at a hardware level, making it faster than Programmable Limit Switch (→ p. 1), which is done through firmware.

10.2.1 Configuring Position Compare

Select Compare Engines under Settings in the EWV¹ navigation tree. This view shows an overview of the two compare engines. Use this view to set each engine's compare source, output, phase advance, and modulo settings.

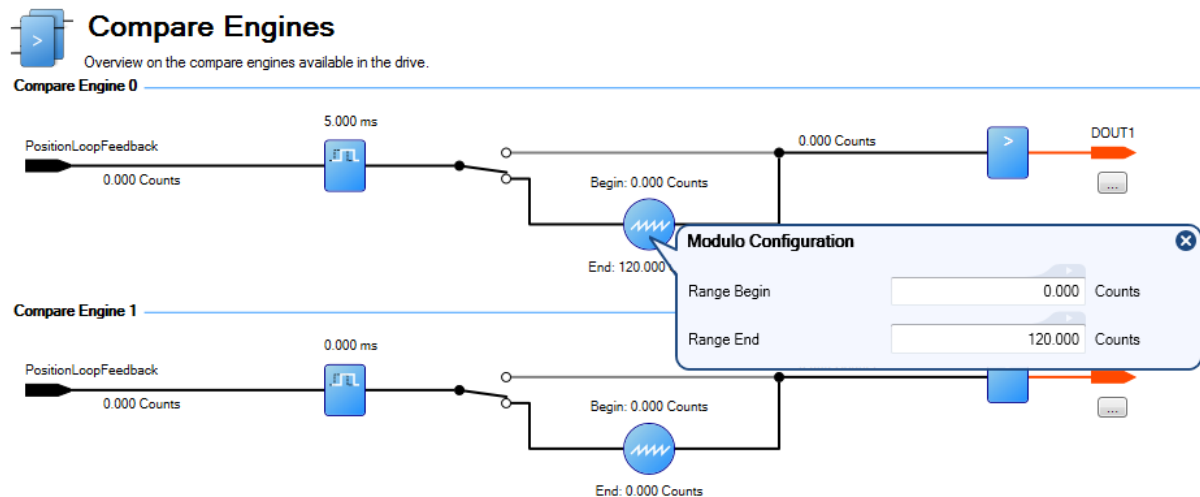

10.2.1.1 Order of Configuration

The compare parameters, CMPx.SOURCE, CMPx.MODBOUND1, CMPx.MODBOUND2, CMPx.WIDTH and CMPx.MODEN must be set prior to arming setpoints with CMPx.ARM. If CMPx.SETPOINT is not set prior to CMPx.MODEN or CMPx.ARM an error message will not be gen-

¹Embedded Workbench Views

erated, but the compare will trigger at either the last set value or the default value of 0 if the drive has been power cycled or rebooted.

Prior to enabling modulo functionality with CMPx.MODEN, CMPx.SOURCE, CMPx.MODBOUND1, CMPx.MODBOUND2, and CMPx.WIDTH must all be set.

10.2.1.2 Setting Compare Sources (CMPx.SOURCE (→ p. 306))

Compare setpoints are compared against compare sources. If they match, an output pulse is generated. Use CMP0.SOURCE and CMP1.SOURCE to select the source which the compare setpoints will be compared against.

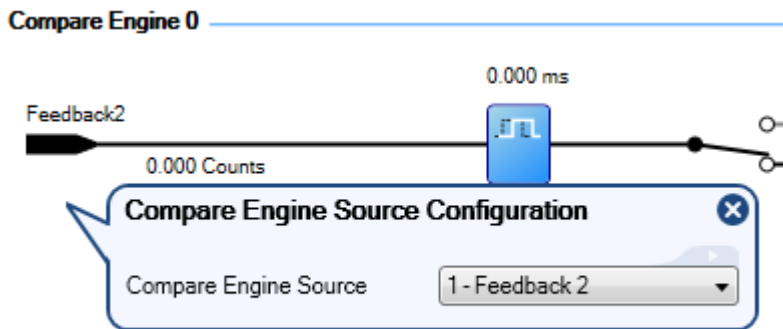

Compare Engine 1

Select one of the following compare source values:

Value	Description
0	Triggers output based on a compare with the primary feedback position (FB1.P (→ p. 461)), independent of the value of PL.FBSOURCE (→ p. 626). The units of the primary feedback are determined by FB1.PUNIT (→ p. 470).
1	Triggers output based on a compare with the secondary feedback position (FB2.P (→ p. 1)), independent of the value of PL.FBSOURCE. The units of the secondary feedback are determined by FB2.PUNIT (→ p. 1).
2	Triggers output based on a compare with the tertiary feedback position (FB3.P (→ p. 488)), independent of the value of PL.FBSOURCE. The units of the tertiary feedback are determined by FB3.PUNIT (→ p. 493).
3	Triggers output based on the position of PL.FB (→ p. 625). The units of the position feedback are determined by UNIT.PROTARY (→ p. 1) or UNIT.PLINEAR (→ p. 1).

10.2.2 Setting Compare Setpoints (CMPx.SETPOINT (→ p. 304))

Each compare engine has eight independent setpoints that can trigger output pulses with widths in either position or time. Use a compare engine's view to set each setpoint's value, width, width-type, mode, and to arm each setpoint.

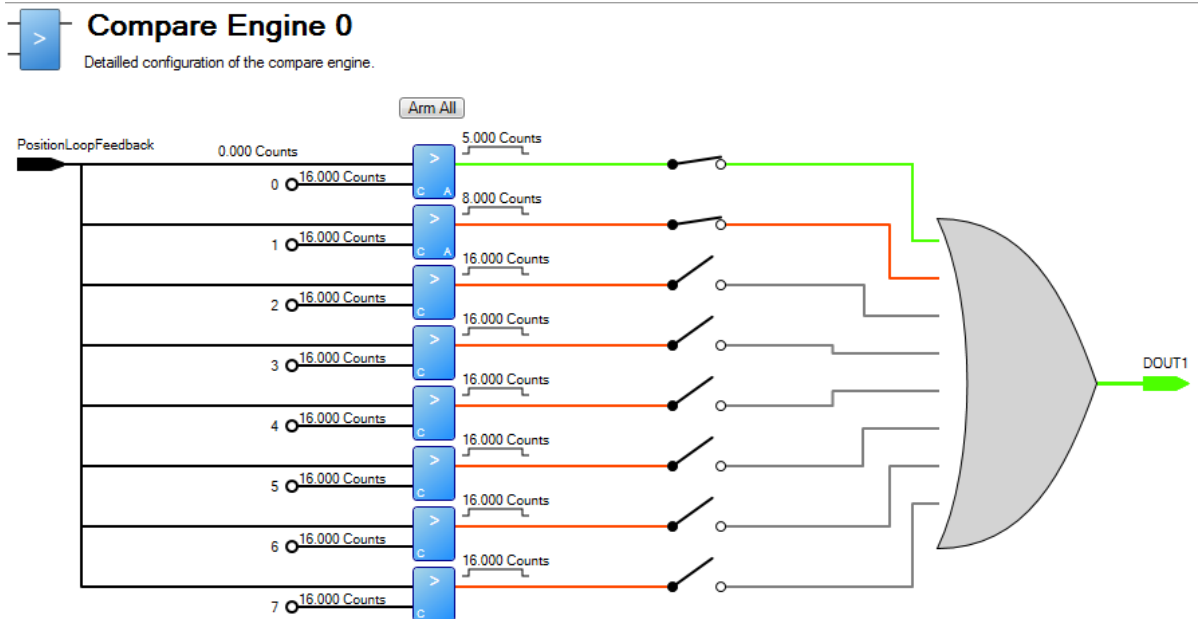

Each setpoint has either a C or S in its lower left corner, indicating either continuous or single-shot mode.

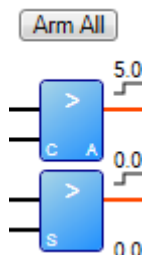

Setpoints can be armed using CMPx.ARM. In EwV, all setpoints can be armed for a given engine using the **Arm All** button. If a setpoint is armed, an A will appear in the bottom right corner of its graphic.

Related Topics

CMP Parameters (→ p. 294)

10.3 Enable/Disable

10.3.1 Enable Modes

The AKD PDMM offers several options for hardware and software enables, as well as safe torque off (STO) to cover a variety of conditions.

Hardware Enable Mode

The AKD PDMM has two hardware enable methods. These methods are controlled by DRV.HWENMODE. Mode 0 allows for the drive to enable and clear faults on the rising edge of the hardware enable input. Mode 1 will NOT clear any faults on the rising edge of the hardware enable input, allowing the review of any current faults for manual clearing.

Software Enable Default

In addition, the Software Enable has two methods for enabling the AKD PDMM. These are controlled by `DRV.ENDEFAULT`. Default 0 leaves the software in the disabled state upon start-up. Default 1 enables the software upon start-up.

10.3.2 Disable Modes

Use `DRV.DISMODE` to select the method for stopping the drive.

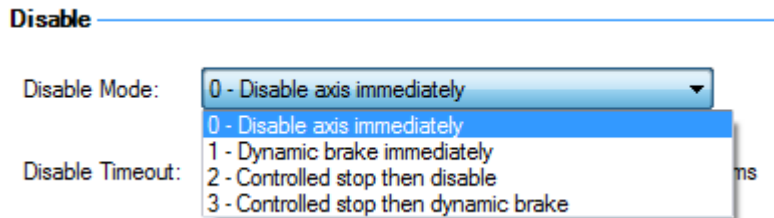

Mode 0: Immediately disable drive.

With this condition, the drive will immediately disable the power stages and the driven motor will either coast to a stop or in the case of a vertical or overhung load axis, will fall abruptly. If a brake is present, the brake will be applied according to `MOTOR.BRAKEIMM` (→ p. 577) and `MOTOR.TBRAKEAPP` (→ p. 604). Using Digital Input mode 13, you can achieve a controlled stop as described in Mode 2.

Mode 1: Dynamic Brake to a stop.

In this situation, the drive will use the dynamic brake feature and stop motion quickly, and then disable the power stage. In most cases, the driven motor will stop quickly (pending the joules available and load circumstances). In the case of an overhung or vertical load, the driven motor will attempt to stop, but then will continue to allow the load to fall if no measures have been taken to secure the load.

Mode 2: Controlled stop, then disable.

In this mode, a controlled stop will take place based on a variety of parameters that you set. First, the driven motor will decelerate at a controlled rate (`CS.DEC` (→ p. 314)) until one of two things happens. 1) The motor reaches the velocity limit set (`CS.VTHRESH` (→ p. 317)) for a period of time (`CS.TO` (→ p. 316)), or 2) The drive emergency time out is reached (`DRV.DISTO` (→ p. 375)). Once either of these cases is reached, the power stage will be disabled (and brake applied if present)

Mode 3: Controlled stop, then dynamic brake.

Similar to Mode 2, the motor will decelerate at a controlled rate (`CS.DEC`) until `CS.VTHRESH` is reached for a period of time (`CS.TO`). The drive will then dynamically brake and disable under the same conditions as described in Mode 1.

The Disable Timeout Setting determines the amount of time the drive will follow the disable mode before it deactivates the drive regardless of method chosen and alerts with an Emergency Timeout Fault.

All disable modes operate based on the type of disable command received. Any critical faults, hardware disable, or STO disable immediately turn off the power stage, and the motor will coast or free fall, depending on how the motor is secured.

10.3.3 Drive Status

The **Drive Status** area is displayed below the settings area and includes a graphical representation of drive active status with different sets of inputs. If the input or output is enabled, then it is shown in green; if the input or output is disabled, then it is shown in red. The inputs to the OR and & (AND) gates identify which conditions are true (green) or false (red) and follow the normal logic for & (AND) and OR gates. This diagram is useful for finding which input may be preventing the drive from being enabled.

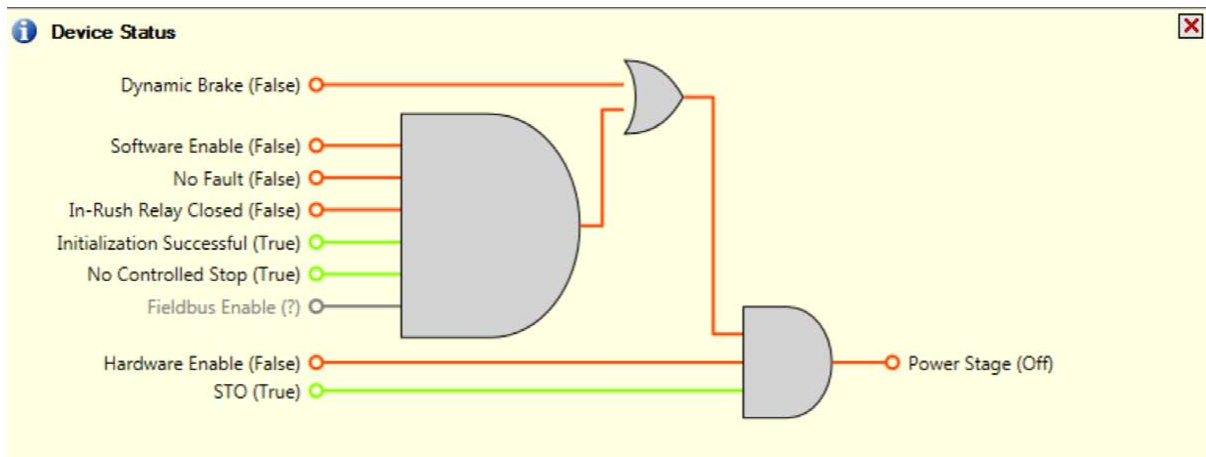

10.3.4 Controlled Stop

The Controlled Stop area displays values for parameters associated with controlled stop.

Button or Dialog Box	Description	Parameter
Velocity Threshold	Sets the velocity threshold for controlled stop process.	CS.VTHRESH (→ p. 317)
Velocity Threshold Timeout	Sets the velocity threshold, which is the time value for the drive velocity to be within CS.VTHRESH before the drive disables	CS.TO (→ p. 316)
Deceleration	Sets the deceleration value for the controlled stop process.	CS.DEC (→ p. 314)
Control stop Input	Displays the list of digital inputs configured to controlled stop mode separated by ','. When no controlled stop mode is configured, this box displays the message: No CS Input Configured . The Configure Input link opens the Digital I/O screen where you can configure the controlled stop mode.	

10.3.5 More/Less Button

The **More** button reveals the status diagram for the controlled stop configuration. It also displays the block diagram for the control stop. Two block diagrams are available: one for a brake fitted and another for no brake.

Control stop status diagram

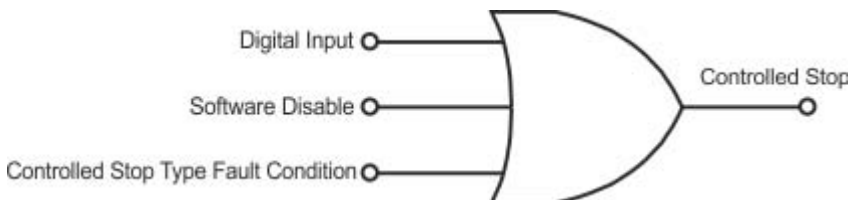

Controlled Stop Block Diagram

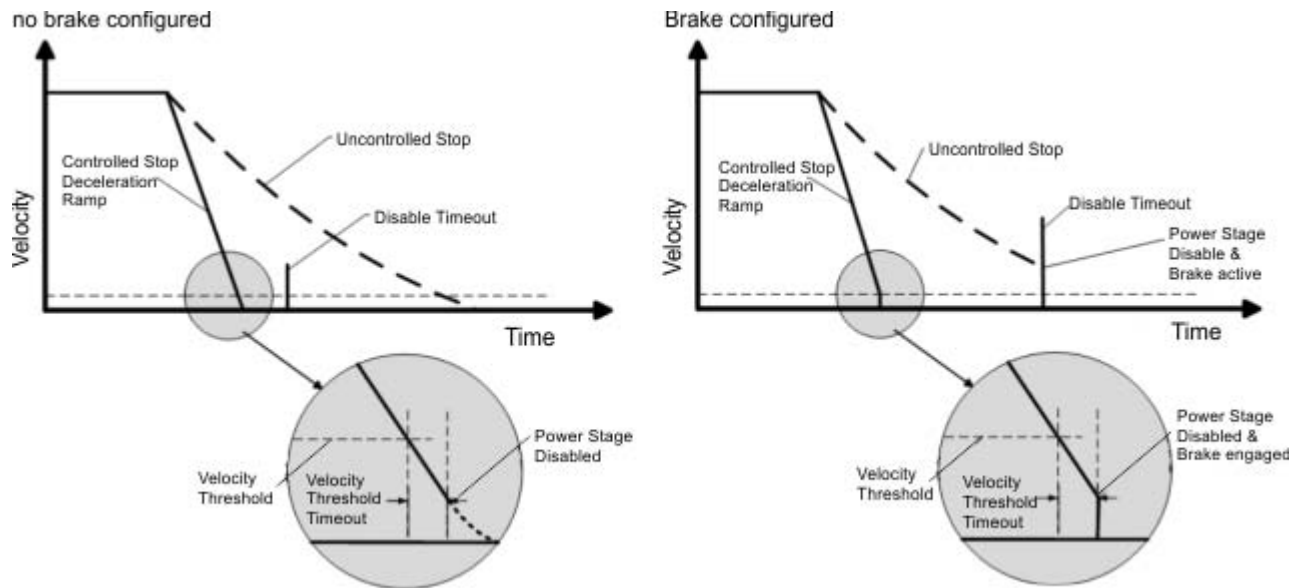

10.4 Controlled Stop

In a controlled stop, drive motion is brought to a standstill in a controlled manner. The drive commands a zero velocity from the motor. The motor decelerates at the prescribed deceleration value (CS.DEC (→ p. 314)).

A controlled stop can occur in three ways:

- The user configures a programmable digital input to mode 13 using `DINx.MODE`. For example, if `DIN1.MODE 13` is applied, digital input 1 is set to controlled stop.
- Either a controller or the user (through the `EWV1` terminal window) initiates a software disable (`DRV.DIS`) command.
- A fault initiates a controlled stop from the drive. See Fault and Warning Messages (→ p. 174) for the faults which initiate a controlled stop.

The controlled stop mechanism is activated in the following cases:

- `DRV.DISMODE = 2` and user executes `DRV.DIS` from the terminal or `EWV` disable buttons.

NOTE

You must disable the drive in order to set `DRV.DISMODE`.

- `DRV.DISMODE = 2` and user executes `DRV.DIS` from a fieldbus connected to the drive.
- A fault occurs which has a controlled stop (CS) reaction. After the CS is executed, the drive disables.
- A digital input mode (`DINx.MODE`) is set to 13. If the digital input state changes (active high or low according to `DINx.INV`) the CS is executed, and then the drive disables.
- HW limit switch: A digital input is defined as a positive (negative) limit switch (`DINx.MODE 18` or `19`). When the limit switch is met, the CS mechanism starts running. In this case, the parameter `DRV.DISTO` is not active.
- SW limit switch: `SWLS` defines an active SW limit. When the limit is met, the CS mechanism starts running. In this case, the parameter `DRV.DISTO` is not active.

Use the drive CS parameters to configure a controlled stop as follows:

¹Embedded Workbench Views

1. CS.DEC: Deceleration ramp that is used for disable.
2. CS.VTHRESH: Velocity 0 threshold. The motor shaft is considered as stopped as soon as the actual velocity (filtered through a 10 Hz filter, such as VL.FBFILTER) is within \pm CS.VTHRESH.
3. CS.TO: Velocity 0 time. The actual velocity must be consecutively within $0 \pm$ CS.VTHRESH for the time CS.TO, before the drive completes the CS process. This value is used since the motor can overshoot out of the VEO window depending on the gains, deceleration ramp, motor inertia and so on.
4. DRV.DISTO: Disable time out. This parameter sets an overall and independent running check as to whether or not the drive can achieve the disable state. If the VEO window set in step 3 is too small, it is possible that the drive may never reach the end of the CS process. The DRV.DISTO parameter and functionality addresses this issue by disabling the drive after the DRV.DISTO time elapses, even if the CS process did not end.

Controlled Stop Diagram

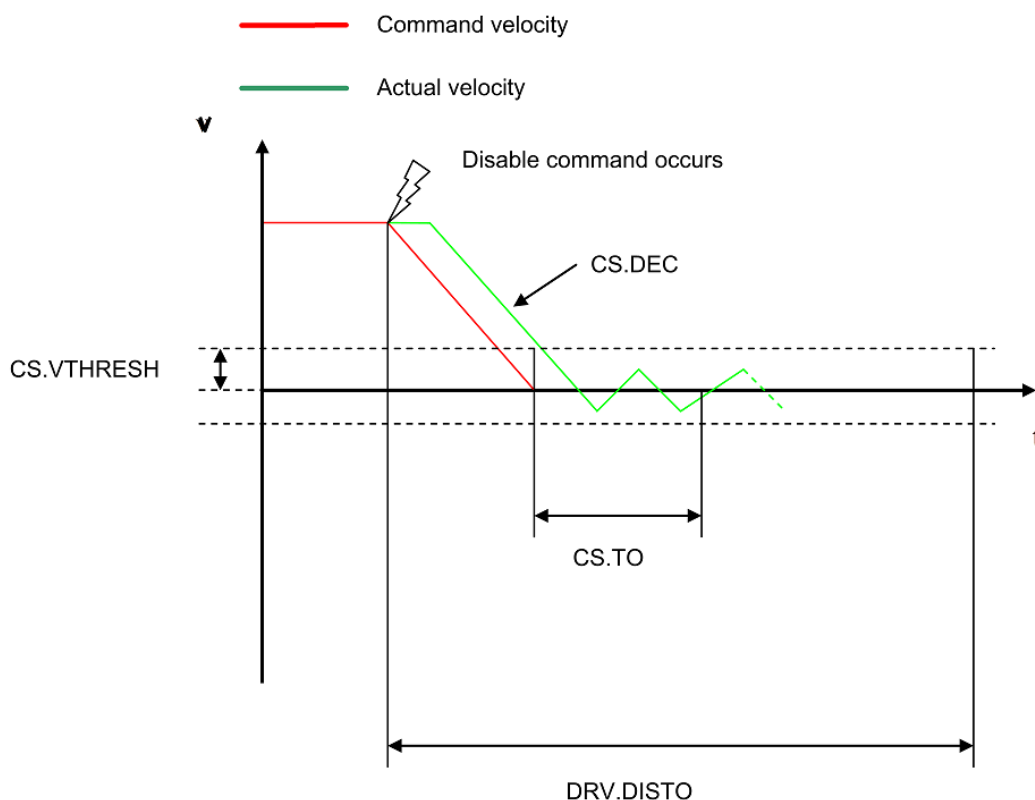

When configuring the controlled stop feature, please note the following:

- If the HW limit switch is active and any of the other CS activated, the only difference will be that in this case the DRV.DISTO will limit the time before disabling the drive.
- If the value of DRV.OPMODE of the drive is current mode, the drive will not execute the CS but instead stop immediately.
- Set DRV.DISTO to an appropriate value that will allow the motor to decelerate from any velocity to 0 with DRV.DEC. This value must also allow the motor to afterwards remain within VL.FB for CS.TO consecutively within $0 \pm$ CS.VTHRESH.

The drive issues a fault FF703 (→ p. 191) in case that the DRV.DISTO counter expires during a controlled stop procedure.

Related Parameters and Commands

CS Parameters (→ p. 313)

CS.STATE (→ p. 315): Reads the current state of controlled stop process (0 = controlled stop is not occurring. 1 = controlled stop is occurring).

DIN1.MODE TO DIN7.MODE (→ p. 325)

DRV.DIS (→ p. 371)

DRV.DISTO (→ p. 375)

DRV.DISMODE (→ p. 372)

Related topics:

Emergency Stop (→ p. 84)

1 Digital Inputs and Outputs

Fault and Warning Messages (→ p. 174)

10.5 Dynamic Braking

Dynamic braking is a method to slow a servo system by dissipating the mechanical energy in a resistor driven by the motor back EMF. The drive has a built in advanced dynamic braking mode which operates fully in hardware. When activated, the drive shorts the motor terminals in phase with the back EMF (q axis) but continues to operate the non-force producing current loop (d-axis) with 0 current. This action forces all of the dynamic braking current toward stopping the motor current and insures the fastest stopping of motor terminal current.

The drive hardware also limits the maximum dynamic braking motor terminal current via the DRV.DBILIMIT parameter to prevent the drive, motor, and customer load from encountering excessive currents/forces. When the current is not being limited, the mechanical energy is dissipated in the motor terminal resistance. When the current is being limited, energy is returned to the drive bus capacitors. When the amount of returned energy raises the bus capacitor voltage enough, the drive activates the regeneration control to start transferring the returned energy to the regen resistor. This resistor could be internal or external to the drive depending on drive model and drive wiring.

Whether and how the drive uses dynamic braking mode depends on the drive disable mode (DRV.DISMODE) setting.

10.5.1 Drive Regeneration

When the servo motor is slowing down at a rate faster than friction and motor losses would slow the motor, then mechanical energy can be returned to the drive. This returned energy initially drives the internal bus voltage upwards. When the returned energy is high enough, the regeneration control transfers the excess returned energy into the regeneration power resistor. If the regeneration control cannot fully handle the power returned (for example, because there is not a regen resistor present or its resistance value is too high), then the bus voltage will continue to rise and a bus over voltage fault will happen and disable the drive completely, which allows the motor to freewheel.

AKD-M00306 to AKD-M00606

These units do not have an internal regeneration resistor. In many applications machine friction, motor losses, and the limited bus capacitor energy absorption handles the application. But, depending on the exact application requirements, an external resistor can be connected.

AKD-M01206 to AKD-Mzzz07

These units have an internal regeneration resistor plus the capability to connect an external resistor if higher power levels are needed.

Related Topics

See section 6.14 *Dynamic Braking* in the *AKD PDMM Installation Manual* for detailed information on dynamic braking.

DRV.DISMODE (→ p. 372)

DRV.DBILIMIT (→ p. 365)

10.6 Emergency Stop

10.6.1 Stop / Emergency Stop / Emergency Off

The control functions Stop, Emergency Stop and Emergency Off are defined by IEC 60204. Notes for safety aspects of these functions can be found in ISO 13849 and IEC 62061.

NOTE

The parameter DRV.DISMODE must be set to 2 to implement the different stop categories. Consult the *AKD PDMM User Guide* for configuring the parameter.



WARNING

With vertical load the load could fall. Serious injury could result when the load is not properly blocked. Functional safety, e.g. with hanging load (vertical axes), requires an additional mechanical brake which must be safely operated, for example by a safety control.

Set parameter MOTOR.BRAKEIMM to 1 with vertical axes, to apply the motor holding brake immediately after faults or Hardware Disable.

10.6.1.1 Stop

The stop function shuts down the machine in normal operation. The stop function is defined by IEC 60204.

NOTE

The Stop Category must be determined by a risk evaluation of the machine.

Stop function must have priority over assigned start functions. The following stop categories are defined:

Stop Category 0

Shut-down by immediate switching-off the energy supply to the drive machinery (this is an uncontrolled shut-down). With the approved safety function STO the drive can be stopped using its internal electronics (IEC 61508 SIL2).

Stop Category 1

A controlled shut-down, whereby the energy supply to the drive machinery is maintained to perform the shut-down, and the energy supply is only interrupted when the shut-down has been completed.

Stop Category 2

A controlled shut-down, whereby the energy supply to the drive machinery is maintained.

Stop Category 0 and Stop Category 1 stops must be operable independently of the operating mode, whereby a Category 0 stop must have priority.

If necessary, provision must be made for the connection of protective devices and lock-outs. If applicable, the stop function must signal its status to the control logic. A reset of the stop function must not create a hazardous situation.

10.6.1.2 Emergency Stop

The Emergency Stop function is used for the fastest possible shutdown of the machine in a dangerous situation. The Emergency Stop function is defined by IEC 60204. Principles of emergency stop devices and functional aspects are defined in ISO 13850.

The Emergency Stop function will be triggered by the manual actions of a single person. It must be fully functional and available at all times. The user must understand instantly how to operate this mechanism (without consulting references or instructions).

NOTE

The Stop Category for the Emergency Stop must be determined by a risk evaluation of the machine.

In addition to the requirements for stop, the Emergency Stop must fulfil the following requirements:

- Emergency Stop must have priority over all other functions and controls in all operating modes.
- The energy supply to any drive machinery that could cause dangerous situations must be switched off as fast as possible, without causing any further hazards (Stop Category 0) or must be controlled in such a way, that any movement that causes danger, is stopped as fast as possible (Stop Category 1).
- The reset must not initiate a restart.

10.6.1.3 Emergency Off

The Emergency Off function is used to switch-off the electrical power supply of the machine. This is done to prevent users from any risk from electrical energy (for example electrical impact). Functional aspects for Emergency Off are defined in IEC 60364-5-53.

The Emergency Off function will be triggered by the manual actions of a single person.

NOTE

The result of a risk evaluation of the machine determines the necessity for an Emergency Off function.

Emergency Off is done by switching off the supply energy by electro-mechanical switching devices. This results in a category 0 stop. If this stop category is not possible in the application, then the Emergency Off function must be replaced by other measures (for example by protection against direct touching).

10.7 Under Voltage Fault Behavior

You can adjust the conditions for an under voltage fault using `VBUS.UVMODE` in the [EWV Terminal](#) (→ p. 166) View:

VBUS.UVMODE = 1 (default)

The drive will not report an under voltage fault unless the drive is enabled and `VBUS.VALUE` falls below `VBUS.UVFTHRESH`

VBUS.UVMODE = 0

The drive will report an under voltage condition any time `VBUS.VALUE` falls below `VBUS.UVFTHRESH`.

When an under voltage fault occurs, the drive is disabled and issues the following alerts:

- EWV alert: 502 Bus Under Voltage
- Drive LED alert: Left LED displays [F], right LED displays [u-V].\
- Fault relay output turns on.

10.7.1 Current Loop Gain Scheduling

This feature is needed when the motor inductance is saturated during normal operation. Because the current loop gain is calculated using the motor inductance, if the inductance changes, the current loop is at risk of becoming unstable.

If a motor is being used under high loads, the inductance is probably saturating if one or more of the following occurs:

- Audible chirping occurs.
- Chirping gets louder with higher commanded current.
- Instability occurs under high current loads (at or near MOTOR.IPEAK (→ p. 589))

To fix this problem, gain scheduling can be used to change the current loop gain as a function of the measured current, IL.FB (→ p. 533).

10.7.1.1 Using the Gain Scheduling View in EWV

To use this feature effectively, you should have either an inductance chart of motor inductance as a function of current, or you must have an idea of how the current loop is performing.

If a chart of motor inductance versus current command is available, it is possible to calculate the required current loop gain values over the range of motor currents.

Current Loop Gain = $2000 * 2\pi * \text{Motor Inductance (H)}$

Example

Motor Inductance is 3.19 mH, current loop gain would be 40.01

Current Loop Gain = $2000 * 2\pi * 0.00319 = 40.01$

Once suitable values have been identified, you can enter these values into EWV¹ in the **Gain Scheduling** view. The **Import** and **Export** buttons at the bottom of the view allow you to import and export data as .csv files.

¹Embedded Workbench Views

Gain Scheduling

[Learn more about this topic](#)

Advanced user current loop gain lookup table for special motors that have varying inductance.

Drive IPeak : Ams

Proportional Gain : V/A

IL.CMD (A)	Table Index	Value (%)	Resulting IL.KP
0.000	0	100.000	400.072
0.115	1	99.607	398.500
0.229	2	99.607	398.500
0.344	3	99.607	398.500
0.459	4	99.607	398.500
0.573	5	99.607	398.500
0.688	6	99.607	398.500
0.803	7	99.607	398.500
0.917	8	99.607	398.500
1.032	9	99.607	398.500
1.146	10	99.607	398.500
1.261	11	99.607	398.500
1.376	12	99.607	398.500

IL.CMD Vs Resulting IL.KP

By default, the current loop value will be what is defined in IL.KP across the whole range of currents. To change the value of IL.KP over a range of values, simply enter a scaling term: 0 - 100% of the current value.

Example

If the current loop gain entered on IL.KP was 40.124 (shown above) and a current loop gain of 36 was desired, a scaling term of 90% should be entered for the desired current ranges.

$$40.124 * 0.90 = 36.112$$

Using the Terminal View for Gains Scheduling

You can also use the Terminal to set up the Gains Scheduling Table. If you use the Terminal, then two parameters are required for each lookup table point: IL.KPLOOKUPINDEX (→ p. 547) and IL.KPLOOKUPVALUE (→ p. 548). IL.KPLOOKUPINDEX specifies the lookup table index (0 – 255), and IL.KPLOOKUPVALUE specifies the scaling term (0 – 100%) to scale IL.KP.

The current to which a lookup index refers can be calculated as follows:

$$IL.CMD \text{ Range} = DRV.IPEAK/157 * IL.KPLOOKUPINDEX$$

A full list of table values can also be retrieved using IL.KPLOOKUPVALUES (→ p. 549), which returns a comma delimited table as follows:

```
-->IL.KPLOOKUPVALUES

Index Value
0, 100.000
1, 100.000
2, 100.000
```



```
3, 100.000  
4, 100.000  
5, 100.000  
6, 100.000  
7, 100.000  
8, 100.000  
9, 100.000  
10, 100.000
```

11 Creating Motion

11.1 Service Motion	91
11.2 Motion Profile Table	92

11.1 Service Motion

Service Motion allows you to set up simple motion (Command Source must be set to Mode 0 - Service). It is typically used during initial set up to exercise the system. It can be used to help troubleshoot the system, execute tuning, make repetitive moves for verification of mechanical set up, or for other general simple motion needs. There are multiple ways to set up motion depending on the desired result in torque, velocity or position modes. In all modes, you can run a momentary pulse, set up reversing motion, or initiate continuous motion.

Service Motion

Service motion allows you to start and stop some test motions.

Service Motion Mode: Pulse Reversing Continuous

Group:

Current 1: Ams

Time 1: ms

Drive is inactive.

Position Feedback: Counts16Bit

Velocity Feedback: rpm

Current Feedback: Ams

The chart below identifies the commands available on the **Service Motion** view:

Button or Dialog Box	Description
Pulse	Alternates between the commanded current or velocity and zero velocity. You can specify the time period between the commanded value and the return to zero. Setting a time to zero will generate a continuous command.
Reversing	Alternates between the two commanded values. You can specify the time the command will be held in each state.
Continuous	Runs the commanded current or velocity continuously.
Group	Selects parameter group to be used with service motion. Group 1 selects parameter group for SM.MODE 0, and group 2 selects parameter group for SM.MODE 2. See SM.MODE (→ p. 670) for more details.

Button or Dialog Box	Description
Current 1/Current 2	Sets the two different currents.
Time 1/Time 2	Sets the time for which the different commands are generated. Setting a time to zero generates a continuous command.
Start/Stop	Starts and stops the motion.
Position Feedback	Displays the present position of the motor.
Velocity Feedback	Displays the present velocity of the motor.
Current Feedback	Displays the present current of the motor.

Related Parameters

SM.I1 (→ p. 668)

SM.I2 (→ p. 669)

SM.I2 (→ p. 669)

SM.MOVE (→ p. 673)

SM.T1 (→ p. 674)

SM.T2 (→ p. 675)

SM.V1 (→ p. 676)

SM.V2 (→ p. 677)

11.2 Motion Profile Table

Motion Profile Tables allow S-Curve and other customer specified velocity profiles. The tables are interpolated to determine the command position each sample during the move. There are two forms of interpolation, OneToOne and Profile Table that are used to create the profile actually used for motion. OneToOne interpolation uses the table for every sample during the motion. Profile Table interpolation uses the table only for acceleration and deceleration with the insertion of a constant velocity section of the move for longer moves.

There are two default tables (Table 0 and Table 1) pre-loaded on AKD PDMM drives. Table 0 is an S-Curve profile that has sinusoidal jerk, acceleration, and velocity profiles. This provides very smooth motion and can be used with either OneToOne or Profile Table interpolation. Table 1 is an asymmetric profile that can only be used with OneToOne interpolation. This has the highest acceleration at low speeds and is an example of a customer table that may decrease overall motion times for systems with high torque at low velocity.

You can define acceleration, velocity, position, and jerk for drive motion tasks using the **Motion Profile Table** view shown below:

⚠ CAUTION

This is a beta feature. Please note that IL.KACCFF should be set to 0 when using this feature.

 **Motion Profile Table** [Learn more about this topic](#)

Edit the motion table that are stored in the Drive.

⚠ Beta feature - may change. Caution: ILKACCF should be set to 0 using this feature !

Tables:

ID	Name	Size	Status

Name:

Position:	Velocity:
Acceleration:	Jerk:

The **Motion Profile Table** view consists of three sections:

- Grid
- Graphical Representation
- Control Buttons

11.2.1 Grid

You can modify motion profile table data using the tables grid on the left side of the view and the Name text box on the right. All profile table data is displayed in the tables grid. This data includes:

- ID: indicates the unique ID number (0 to 7) of the profile table.
- Name: indicates the name of the profile table. By default, a profile table name is 'no_name'. To edit the profile table name select one of the profile tables from the grid, and then change the profile table name by using the **Name** textbox .
- Size: indicates the total count of the profile table data.
- Status: indicates the current status of the profile table in the grid. Before saving a table into the drive, the status displays "Modified" and after saving the drive, the status displays "Sync". If you change the profile table name, then the status displays "Name Modified".

11.2.2 Graphical Representation

On the right side of the Motion Profile Table view, you can view graphical representations of acceleration, velocity, position, and jerk of the selected profile table. Graphs are plotted based on the given data of the profile table. See the screenshot below for typical graphical representations:



Motion Profile Table

[Learn more about this topic](#)

Edit the motion table that are stored in the Drive.

Beta feature - may change. Caution: IL_KACFF should be set to 0 using this feature !

Tables:

ID	Name	Size	Status
0	no_name	1000	Modified

Name:

Position:

Velocity:

Acceleration:

Jerk:

i Table data is modified. Click on Save tables to Drive button to save the t...

11.2.3 Control Buttons

The control buttons at the bottom of the **Motion Profile Table** view allow you to manipulate motion profile tables and data as follows:

Control Button	Description
Add	Adds new profile tables. A new table has a size of zero when it is added to the grid. You can add a maximum of 8 profile tables, numbered 0 to 7.
Remove	Remove profile tables from the grid (in memory). If a profile table is in use by a motion task and you attempt to delete the profile table using the Remove button, then a caution message appears. The caution message shows the affected profile table ID and an option to either continue or not.
CW/CCW	Moves profile table position either up or down in the grid list. If a profile table is in use by a motion task and you attempt to delete the profile table using the Up or Down buttons, a caution message appears. The caution message shows the affected profile table ID and an option to either continue or not.
Save tables to the Drive	Saves a newly added or modified valid profile table to the drive. The current representation in the grid is saved in the drive.

Control Button	Description
Reload tables from Drive	Reloads the table from the drive and overrides the table that is currently in memory.
Cancel	Cancel appears only when the reload operation is in progress. Click Cancel to cancel the profile table reloading operation.
Clear tables in Drive	Clears all the profile tables present in the drive.
Reset to Default Button	Loads the default table map into the memory. The current default map contains only one profile table (S-curve with 1,000 points).
Import	Imports the data from either preset tables within WorkBench or from an external .csv file. When you click Import , the Import Table Data popup screen appears and allows you to select the table size.
Export	Exports data to a .csv file.

11.2.3.1 Import Table Data

The **Import** button opens the **Import Table Data** screen shown below:

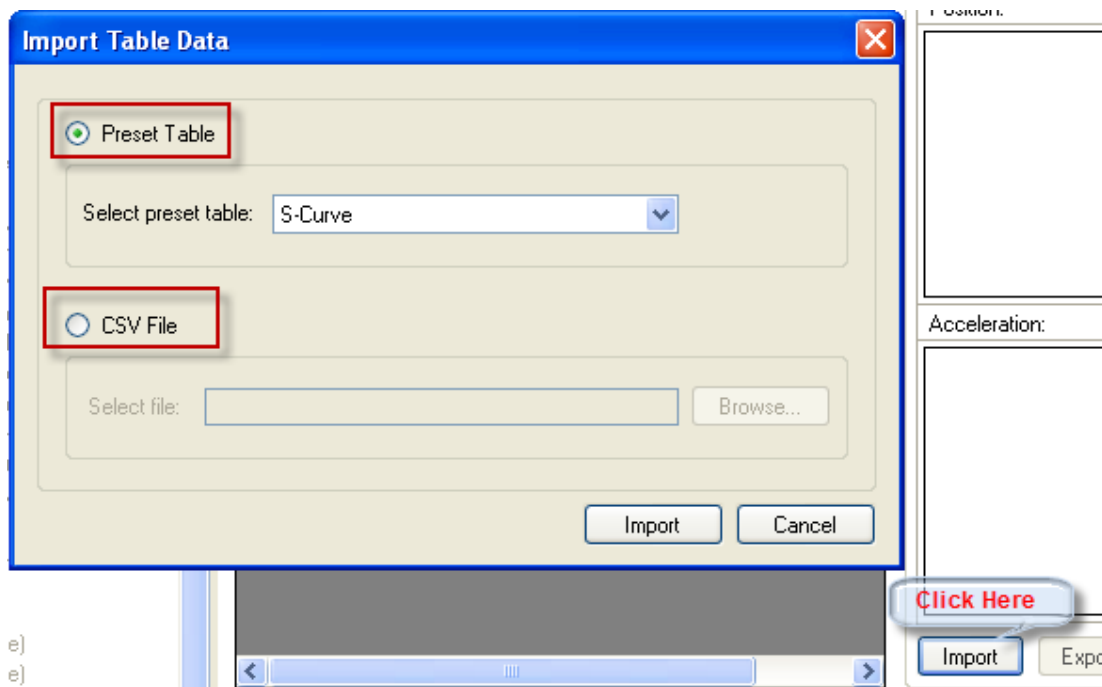

You have two options to provide inputs to the profile table:

- Preset Table
- CSV File

11.2.3.2 Importing data from Preset Table option

By default, the **Preset table** option is selected. You can select one of the preset tables from the **Select Preset Table** box. After selecting the source, click **Import** to complete the import of the data.

After import, the size of the profile table is shown in the grid and you can view the graphical representation of position, velocity, acceleration, and jerk based on the profile table data now loaded into the grid.

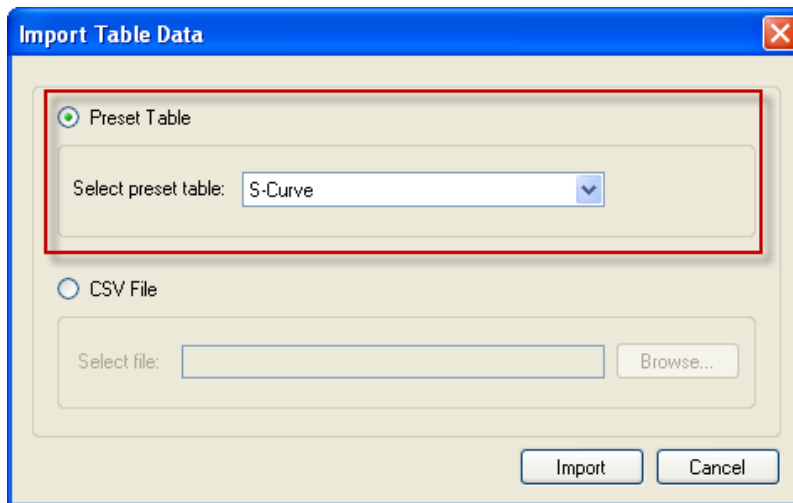

11.2.3.3 Importing data from an external CSV file

You also use the **CSV File** option to import the profile table data from an external .csv file. Select the **CSV File** option and then select the valid file using the browse button. After selecting the source file, click **Import** to complete the import of the data. A message indicates successful data import. After import, the size of the profile table is shown in the grid and you can view the graphical representation of position, velocity, acceleration, and jerk based on the profile table data now loaded into the grid.

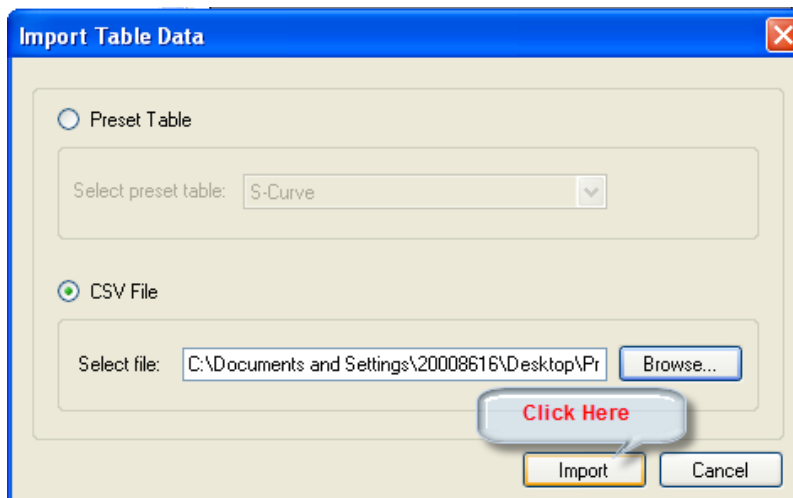

If an invalid source or invalid format is selected, an "Invalid Data Format" message appears.

11.2.4 Creating Motion Profile Tables

A motion profile table is a table of unit-less position values, which are the integral of the velocity profile during the acceleration and deceleration process of a motion task. A motion profile can be stored in the drive and used in order to accelerate and decelerate with a certain profile shape.

The motion profile table describes the shape of the acceleration process, but does not determine how fast the motion task accelerates or decelerates and which target velocity will be reached.

11.2.4.1 Example of a motion profile table

An example of a motion profile table is shown below:

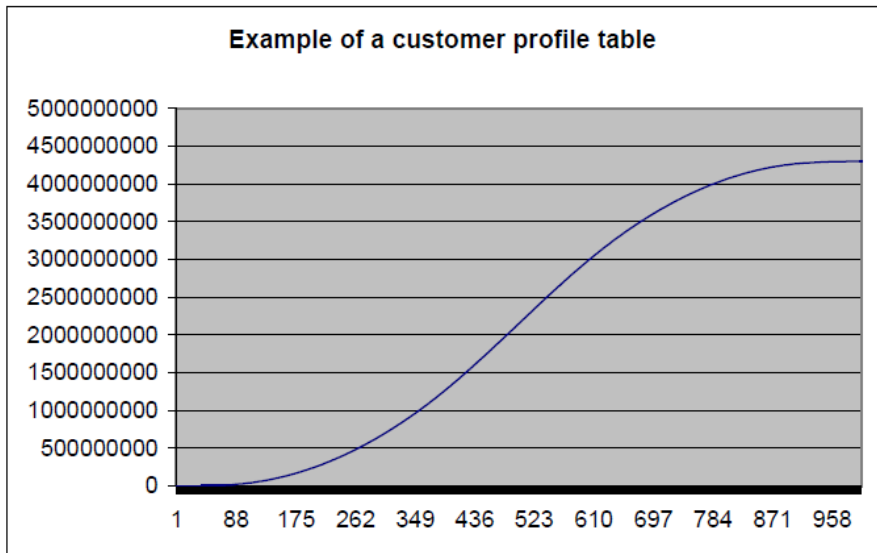

The motion profile table is the integral of the velocity profile. The velocity profile during the acceleration and the deceleration process is shown below:

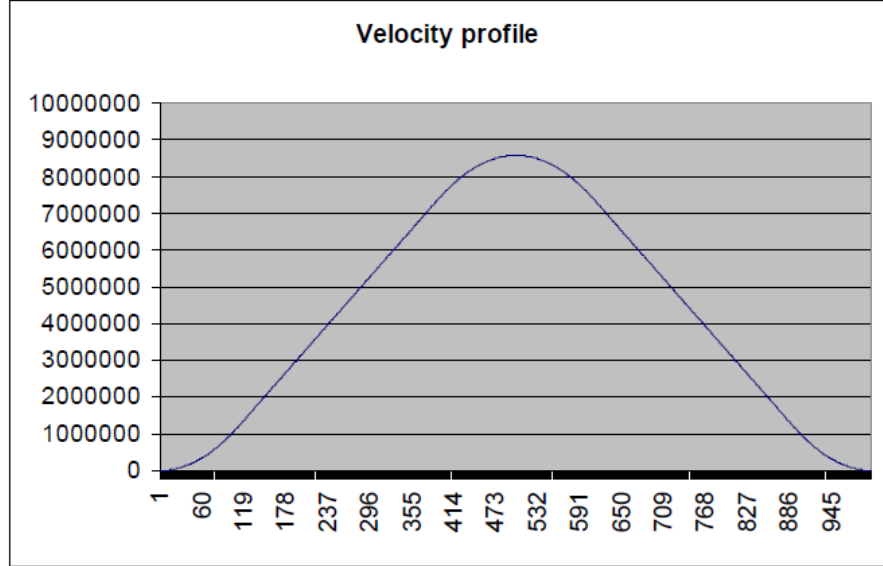

The derivative of the motion profile table is calculated using the following formula:

$$\text{velocity_profile_value}_n = \text{customer_profile_entry}_{n+1} - \text{customer_profile_entry}_n$$

11.2.4.2 Motion Profile Table Restrictions

Restrictions for motion profile tables include the following:

1. A motion profile table needs a reasonable number of entries (usually between 1,000-4,000 entries, depending on the acceleration and deceleration time of a motion task). If an acceleration or deceleration process takes more position-loop samples than half of the motion profile table entries, then the drive interpolates linearly between the single motion profile table entries.
2. The motion profile table should contain an even number of entries. The first point of the customer table starts with the value of 0 and the last point must contain the value of $2^{32}-1$.
3. The motion profile table contains values in ascending order.

- The following motion profile table entry must contain the value of nearly 2^{31} .

$$table_entry = \frac{number_of_table_points}{2} + 1$$

Example

Assume that a motion profile table contains 1,000 data points. In this case point $1000/2 + 1 = 501$ must contain the value of $2^{31} = 2,147,483,648$.

- A motion profile table must also be symmetric during the acceleration and the deceleration process when Profile Table interpolation is used.

To illustrate profile symmetry, the derivative of the motion profile table (velocity profile) is shown below. Note the symmetry according to the velocity profile.

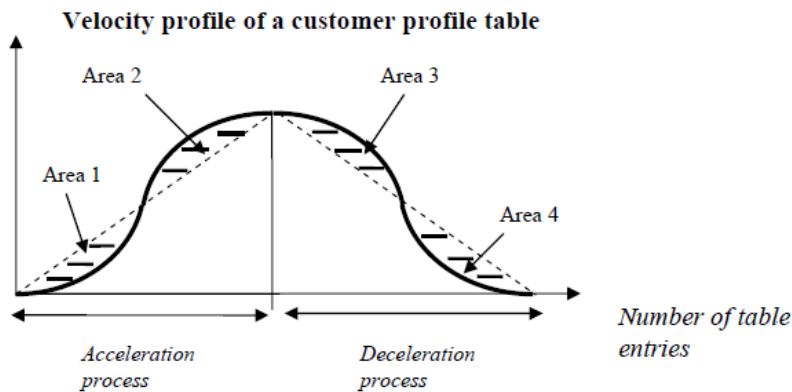

The left half of the curve describes the shape of the acceleration process of the motion task. The right half of the curve describes the shape of the deceleration process of the motion task. A symmetric motion profile table means that Area 1, Area 2, Area 3 and Area 4 have the same size.

11.2.4.3 Different methods of motion table motion tasking

General motion profile table explanations

The algorithm for handling the motion profile motion task are the same for both methods, the standard customer table motion task and the OneToOne customer table motion task. The diagram below illustrates a basic table profile algorithm. The figure shows a standard customer table motion task.

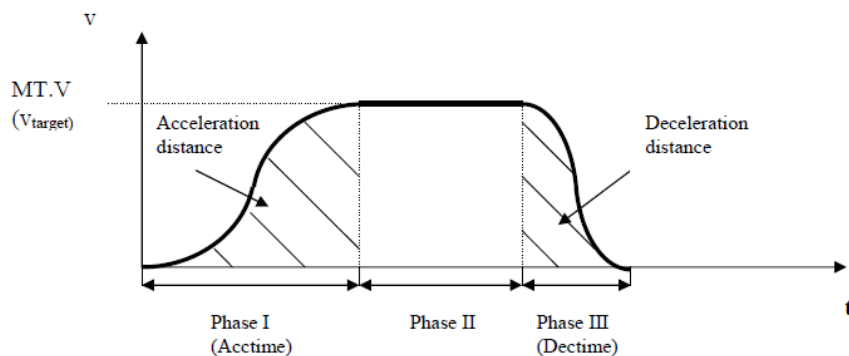

The drive calculates the acceleration time and deceleration time out of the given motion task parameters (see MT Parameters and Commands) with the assumption of a trapezoidal acceleration setting (MT.ACC and MT.DEC). The formulas are:

$$Acctime = \frac{MT.V}{MT.ACC} ; Dectime = \frac{MT.V}{MT.DEC}$$

11.2.4.4 Use of IL.KACCFF with Motion Tables

IL.KACCFF can be used with Profile Table or OneToOne interpolation motion tasks as long as the following criteria is met:

$$(Acctime + Dectime) < (\text{number_of_table_points}/4000)$$

If this criteria is not met, a current spikes at 4KHz will occur.

11.2.4.5 Profile Table Interpolation Motion Task

The Profile Table interpolation motion task is displayed in the following figure:

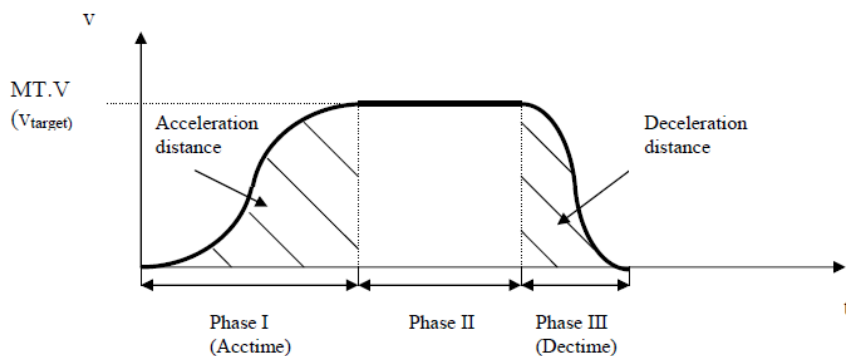

The Profile Table interpolation for a stand-alone motion task (the motion task does not automatically trigger a following motion task) can be separated in three different phases:

1. Phase I: The drive steps within a pre-calculated acceleration time through the first half of the motion profile table and reaches finally the requested target velocity of the motion task.
2. Phase II: The drive inserts a constant velocity phase and checks continuously if a brake-point has been crossed. The brake-point is naturally the target position minus the deceleration distance.
3. Phase III: The drive steps into the second half of the motion profile table and reaches finally the requested target position when the velocity becomes zero. The step into the second half of the motion profile table is a critical point and requires a symmetric table and the value of 231 at entry $\text{number_of_table_points} / 2 + 1$ as explained in 11.2.4.2 Motion Profile Table Restrictions for a customer table.

11.2.4.6 OneToOne interpolation motion task

The OneToOne interpolation motion task is basically very similar to the Profile Table interpolation motion task handling with just a few small differences.

1. The OneToOne customer table motion task does not step out of the table after an acceleration process and inserts a constant profile (Phase II in the section above). The OneToOne handling steps within a pre-calculated time through the whole table in one go and cover the required distance.
2. A change-on-the-fly from one motion task to another without finishing the first motion task is not possible for this mode.
3. The OneToOne profile does not use different acceleration and deceleration values. The AKD PDMM calculates the sum of the acceleration time and deceleration time and uses this total time ($\text{total} = MT.V/DRV.ACC + MT.V/MT.DEC$) for the motion task as explained in the

following picture. In case that the acceleration + deceleration time is too small for moving a certain distance, which would lead into a too large peak-velocity, the total time will automatically be extended to the required value in order to not exceed the maximum allowed velocity to the minimum of MT.V or VL.LIMITP and VL.LIMITN.

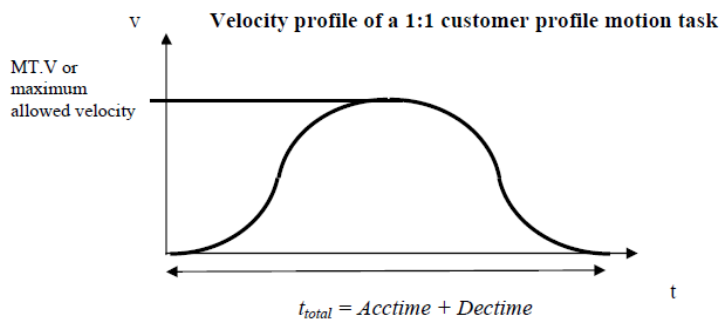

Note that the motion task target velocity is only reached in case of a symmetric table. The velocity will be different when the profile table is non-symmetric.

11.2.4.7 Setting up a motion profile motion task

It is recommended that motion tasks be set up via the EWV¹ software. The S-curve profile or the OneToOne profile may be selected via a drop-down menu.

It is also possible to select to adjust a motion task on a command line level with the help of the MT commands. There are 2 commands which are mentioned within this chapter:

- Trapezoidal, OneToOne, or Profile Table moves are selected using bits 10 and 11 of the MT.CNTL command.
- The MT.TNUM selects which of the 8 tables (0 to 7) to use for the profile. The parameter MT.TNUM will be ignored in the case that a trapezoidal motion task has been selected.

11.2.4.8 Drive reaction on impossible motion tasks

For all motion tasks, which use a motion profile table as the shape for the velocity profile, the motion task properties must be pre-calculated and it must be evaluated in advance, if a motion task can be handled without any problems or if some of the motion task parameters must be re-calculated automatically by the AKD PDMM.

An impossible motion task occurs when the user has not specified enough movement in order to accelerate to the motion task target velocity and to decelerate to velocity 0 without exceeding the distance to travel.

OneToOne interpolation limitations

A OneToOne interpolation motion task cannot be activated while another motion-task is running. A OneToOne interpolation motion task must start from velocity 0.

When using a OneToOne interpolation motion task the AKD PDMM pre-calculates the expected peak-velocity and checks if the velocity exceeds the minimum of the MT.V, VL.LIMITP (→ p. 726) and VL.LIMITN (→ p. 724).

The expected peak-velocity according to the figure above can be calculated via using the following formula:

¹Embedded Workbench Views

$$v_{PeakExpected} = \frac{2 \cdot Distance_to_travel}{t_{total}}$$

The 'distance to travel' is defined in the motion task settings MT.P and MT.CNTL. In case that VPeakExpected exceeds the minimum of the MT.V, VL.LIMITP or VL.LIMITN setting, the AKD PDMM re-calculates the total so that VPeakExpected does not exceed the velocity limitations.

The AKD PDMM accelerates and decelerates within the same time in case of a OneToOne profile and therefore different settings for MT.ACC and MT.DEC are not considered.

11.2.4.9 Profile Table interpolation limitations

Starting from velocity 0 without change-on-the-fly to a following motion task

If there is not enough 'distance to travel' selected by the user in order to accelerate to the target velocity via the selected acceleration (internally converted to acceleration time) and deceleration (internally converted to deceleration time), the AKD PDMM lowers the target velocity automatically to VTargetLimited and accelerates within the selected acceleration time to the limited target velocity and decelerates afterward with the selected deceleration time to velocity 0.

The shape of the velocity profile will look like the following pictures with the assumption, that MT.ACC and MT.DEC have different values.

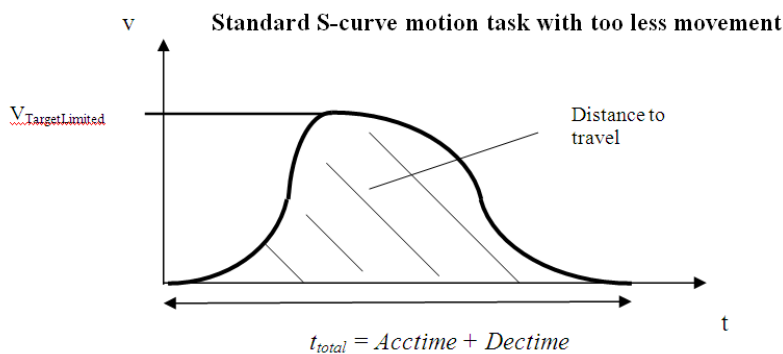

During a change on the fly condition

There are 2 different kinds of considerations within the AKD PDMM firmware for a change-on-the-fly condition.

- A change on the fly in the same direction (the target velocity of the previous and the following motion task have the same algebraic sign).
- A change on the fly in the opposite direction (the target velocity of the previous and the following motion task have a different algebraic sign).

Since the shape of a customer table is unknown to the AKD PDMM, the drive verifies in advance the validity of the motion task with the assumption of a symmetric motion profile table.

Movement to the same direction

The following figure displays a movement in the same direction, in this case in a positive direction.

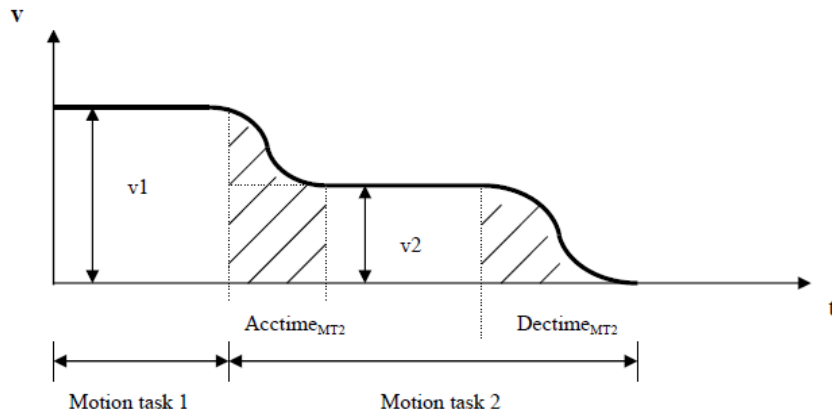

In case that the distance to the target position of the motion task 2 is smaller than $distmin$, the AKD PDMM generates a profile as shown in the next figure.

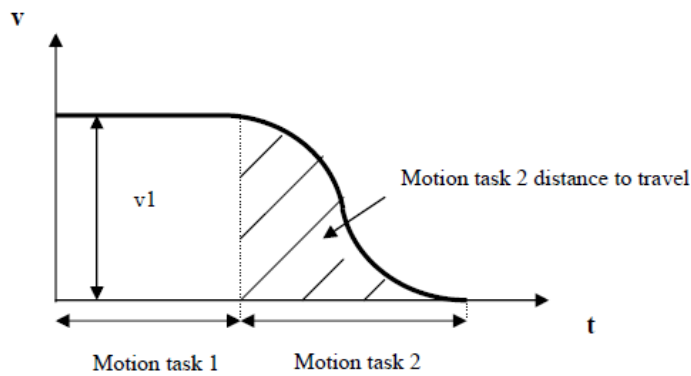

Movement in different directions

The switch on the fly from a positive velocity to a negative velocity is described in the next figure.

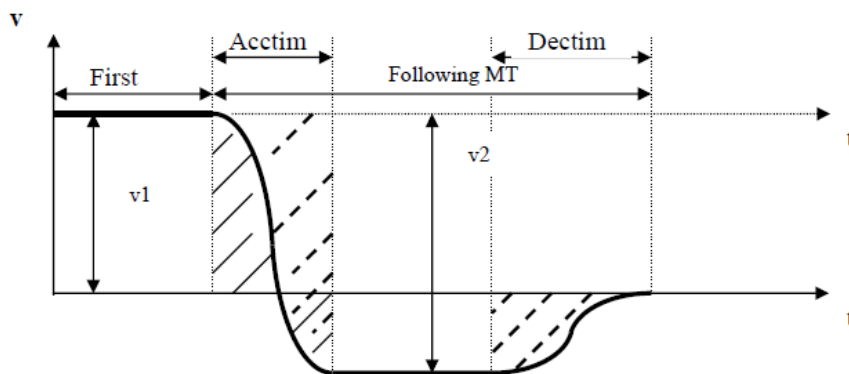

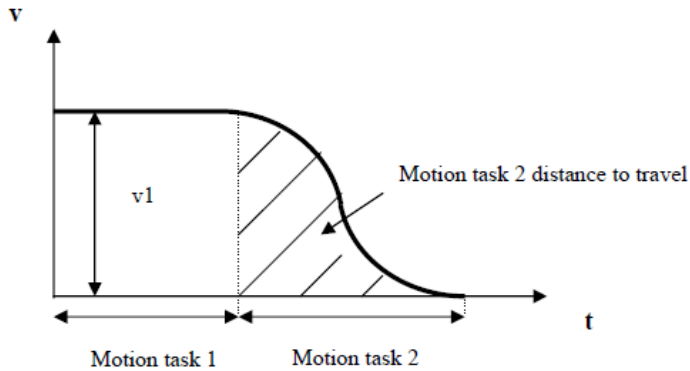

It is not possible to pre-calculate exactly the area, which is marked with solid lines of the following motion task since the shape of the motion profile table is unknown to the drive. This means that it is not possible to identify the movement in positive and negative direction during a change on the fly from v_1 to v_2 . A criterion that a change on the fly will be executed by the drive is, if the total movement in negative direction of the following MT is larger than the area, which is marked with dashed lines. In this case it is ensured, that there will be definitely enough total movement of the MT in negative direction, because the motor moves during the acceleration from v_1 to v_2 also a bit in positive direction. The magnitude of v_2 is in this case the 'target velocity of MT1' + 'target velocity of MT2.'

The drive behaves as follows in case that the hatched area is smaller than the distance to travel negative direction:

1. The drive stops the first motion task with the assigned deceleration ramp.
2. Afterwards the following motion task is triggered automatically by the drive starting from velocity 0.

12 Tuning Your System

12.1 Introduction	105
12.2 Slider Tuning	105
12.3 Using the Performance Servo Tuner	106
12.4 Tuning Guide	135

12.1 Introduction

Most servo systems require some level of tuning (setting up the desired response of the system usually with the load attached). This can be done through several methods available within [EWV](#)¹.



Slider Tuning - Slider tuning offers a very simplistic approach to tuning and can get you under-way quickly. With this method, just the proportional and integral gains are adjusted based on the desired bandwidth you wish to achieve. You can take into account your load inertia if it is known. None of the Bi-quad filters are impacted by the slider tuning.



Performance Servo Tuner - This is an easy way to get a more sophisticated tuning accomplished. The details of how the PST works are included in the advanced section of this subject. However, the PST approach is a simple one-button solution that lets the system configure all of the tuning parameters for you. The PST is a robust solution to get your system tuned and ready to operate in a wide variety of mechanical configurations and loads.

Manual Tuning - Certain applications may require manual tuning where you set the gains and filters based on the specific performance you are looking for. You may also need to "tweak" the tuning that was set up in either the slider or the PST section to optimize your application performance.

12.2 Slider Tuning

This view allows you to vary the tuning of your drive using the slider.



Slider Tuning

[? Learn more about this topic](#)

Select the stiffness you would like.

Do you know your load inertia?

Load inertia: kgcm²

Select desired bandwidth

For very heavily loaded systems.

Default. For heavily loaded or softly coupled systems.

For unloaded and lightly loaded systems.

Bandwidth: Adjust the slider to your desired stiffness

1 300

12.2.1 Load Inertia

¹Embedded Workbench Views

If you know your load inertia (LOAD.INERTIA (→ p. 571)), enter it in kgm^2 for rotary motors, and kg for linear motors. If no load inertia is entered, EWV¹ will assume a 1:1 ratio between your load inertia and motor inertia.

12.2.2 Gentle, Medium, and Stiff

These buttons select three of the most common bandwidths:

- Gentle works in all but the most challenging situations.
- Medium is the default and works in most situations.
- Stiff works for unloaded motors.

12.2.3 The Slider

As you drag the slider to the right, the stiffness increases. In many situations, you cannot drag the slider fully to the right side because the system will become unstable.

12.3 Using the Performance Servo Tuner

12.3.0.1 Overview

The Performance Servo Tuner (PST) tunes your system quickly and easily. The advanced technology in the PST achieves high performance and stability for both simple and complicated loads. It also collects frequency response data (bode plot) that can be used for advanced analysis. The PST can work in a “one button” mode that requires no customization. Settings can be also changed for an array of system requirements (Using the Performance Servo Tuner: Advanced (→ p. 110)).

NOTE

The PST will **not** work reliably on a vertical axis, since the motor may rest against an end stop. In this case, the inertia will not always be correctly identified.

The default PST settings tune systems quickly for good servo performance. If your tuning is not acceptable after running PST, try adjusting the following settings.

- The most common unacceptable tuning result is that the servo bandwidth is too high (very stiff and audibly noisy). To avoid this, try setting the gain margin to 16db and the phase margin to 55deg. This will result in a lower bandwidth and therefore less audible noise. It may also be softer on the system mechanics, but still offer exceptional performance. Use the motion scope to check settling times and overshoots on a typical move to measure performance.
- The PST collects data on the system as it runs. It is important for the PST to collect a robust data set. Try increasing FFT points to 16,384 and number of points to 250,000. This increases the data collection accuracy at low frequency excitations, which can improve the resulting tuning performance. Increasing FFT points and number of points also increases the data collection time. Timing requirements depend on the processing power of the PC running AKD Workbench. If the tuning is not complete after an extreme period of time, cancel the tuning and reduce the points. If possible, try running on a more powerful PC.

Look through the advanced tuning section for more information. Complex systems may require more adjustment.

12.3.0.2 Using the PST

¹Embedded Workbench Views

The PST defaults to a “one button” mode, in which the PST is completely automatic after pushing the start button. In the **Settings** select your desired operation mode, navigate to the **Performance Servo Tuner** view, and then tune your system as follows:

1. Select whether you would like the drive to be tuned in **1-Velocity** or **2-Position** Mode. If the drive is in torque mode, the PST will tune in position mode by default. This is set by using the tool bar and changing the mode to either velocity or position. The drive must be disabled in order to change the operation mode.
2. Click **Start**.

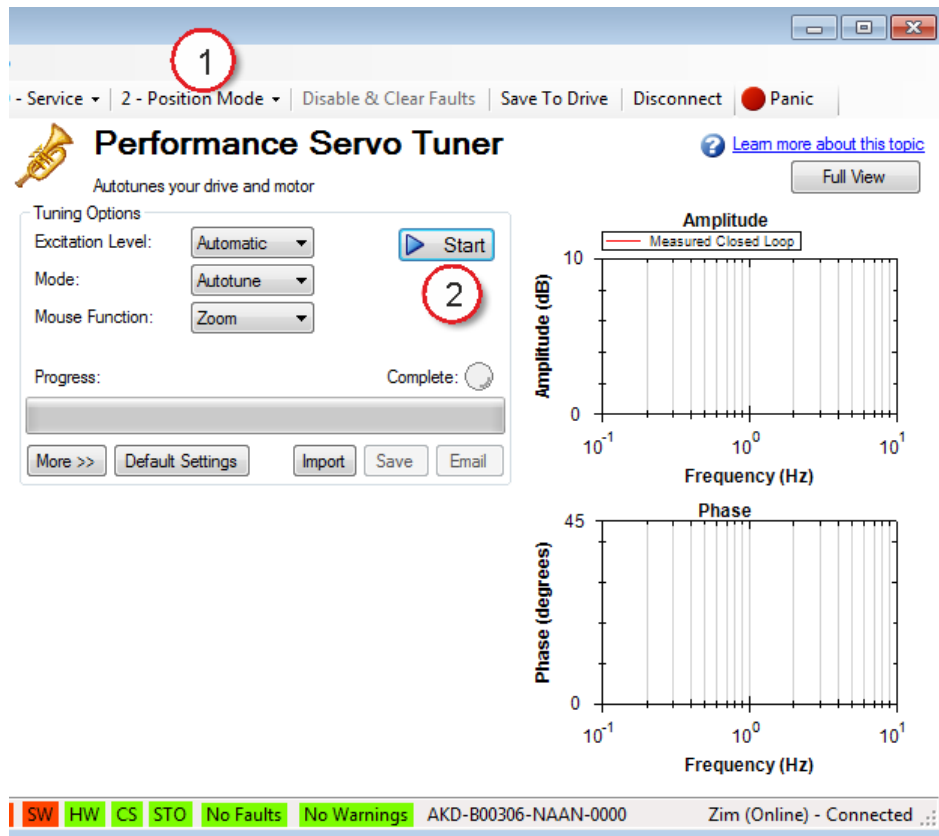

The PST will then perform several tests and display results as shown below. The progress bar (1) shows the relative progress of the PST, so you can estimate when the tuning will be finished. When the tuning is complete, the green **Complete** LED (2) illuminates, and a Bode plot (3) is displayed showing the frequency response of the tuned system.

Performance Servo Tuner
Autotunes your drive and motor

[Learn more about this topic](#) Full View

Tuning Options

Excitation Level: ▶ Start

Mode:

Mouse Function: 2

Progress: Complete 1 Complete:

Measurement

Current Amplitude: 0.095 Measurement:

Velocity Amplitude: 3.063 Injection Point:

Smoothing %: 1.000 Excitation Type:

FFT Points: 4096 Velocity Max: 1000.00 (RPM)

Number Points: 60000 Excite Gap: 2

Amplitude 3

Amplitude (dB) vs Frequency (Hz)

Phase

Phase (degrees) vs Frequency (Hz)

Saving and Emailing Bode Plots

To save screenshots and raw data of a Bode plot, click on either **Save** (1), or **Email** (2).

Tuning Options

Excitation Level: ▶ Start

Mode:

Mouse Function:

Progress: Complete Complete:

1 2

Clicking **Save** opens a prompt to select how to save the screenshot or data. Selecting BMP, JPG, PNG, EMF, or WMF saves the Bode plot as an image. Choosing CSV saves the raw data that is currently plotted as a comma delimited file. Click **Save** to save the file to your hard drive in the desired format.

Save Image/CSV

Export Format

BMP JPG PNG EMF WMF CSV File

Clicking **Email** opens a similar prompt. Select the file format in which you wish to save the image or raw data, and an email will be created for you with the file automatically attached for your convenience. Click **Email** to create the email with the selected file attachment.

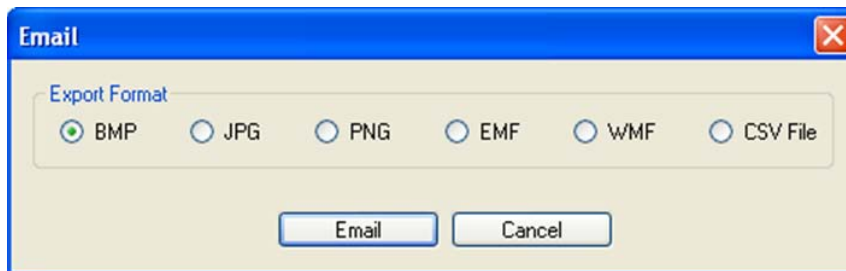

Importing a Frequency Response

If you have previously saved a frequency response measurement into a CSV file, it can be imported for later viewing. Click the **Import** button, and browse to your saved CSV file. You can import while in off-line mode for convenience. Importing a frequency response is useful for off-site developers to analyze a machine tool.

12.3.0.3 Measurement Options

By default, the PST determines the excitation level automatically and autotunes the drive and motor.

The PST also allows you to enter a manual excitation level or to take only Bode measurements (without autotuning the system).

Using Manual Excitation Levels

By default, the PST is set to use the automatic excitation level. To obtain the automatic excitation level, the PST runs a friction test at the beginning to determine how much excitation is needed to break friction and get an accurate measurement.

To change this excitation level, click on the **Excitation Level** drop-down box (1), and select **Manual**. Then enter a new **Current Amplitude** (2) in amps.

Note: If the **Injection Point** is set to **Current**, then the **Current Amplitude** box will be enabled to enter an excitation level; if the **Injection Point** is set to **Velocity**, the **Velocity Amplitude** box will be enabled to enter an excitation level.

Performance Servo Tuner
Autotunes your drive and motor

[Learn more about this topic](#) Full View

Tuning Options

Excitation Level: Manual 1 Start

Mode: Autotune

Mouse Function: Zoom

Progress: Complete Complete:

Less << Default Settings Import Save Email

Autotuner Measur 2 Plots Cursors

Current Amplitude: 0.095 Measurement: Closed Loop

Velocity Amplitude: 3.063 Injection Point: Current

Smoothing %: 1.000 Excitation Type: PRB

FFT Points: 4096 Velocity Max: 1000.00 (RPM)

Number Points: 60000 Excite Gap: 2

Amplitude

Amplitude (dB) vs Frequency (Hz)

Phase

Phase (degrees) vs Frequency (Hz)

SW HW CS STO No Faults No Warnings AKD-B00306-NAAN-0000 Zim (Onl... ..)

12.3.0.4 Taking a Bode Measurement without the PST

You may wish to take only the frequency response of a system, rather than using the PST. To take a frequency response measurement without the PST, click on the **Mode** drop-down box (1) and select **Bode Plot**, then click **Start** (2).

Tuning Options

Excitation Level: Manual Start

Mode: Bode Plot 1 2

Mouse Function: Zoom

Progress: Complete Complete:

Less << Default Settings Import Save Email

12.3.1 Using the Performance Servo Tuner: Advanced

The Performance Servo Tuner (PST) can be set up to use specific modes or limits in tuning to provide tuning in ways you can control, while still taking advantage of the PST's ability to make decisions quickly and effectively for you.

To use the advanced modes of the PST, click the **More** button to display the additional features for advanced autotuning:

12.3.1.1 Typical Cases for Advanced PST Use

Tuning Systems with Low-Frequency Resonances

Systems with low-frequency resonances are challenging because low frequency data is difficult to measure. While the PST can tune these systems, you can expect lower system performance. If your system has a first anti-resonance of 30 Hz (pictured below), you can expect approximately 15 Hz (half the frequency of the first anti-resonance) of closed loop bandwidth.

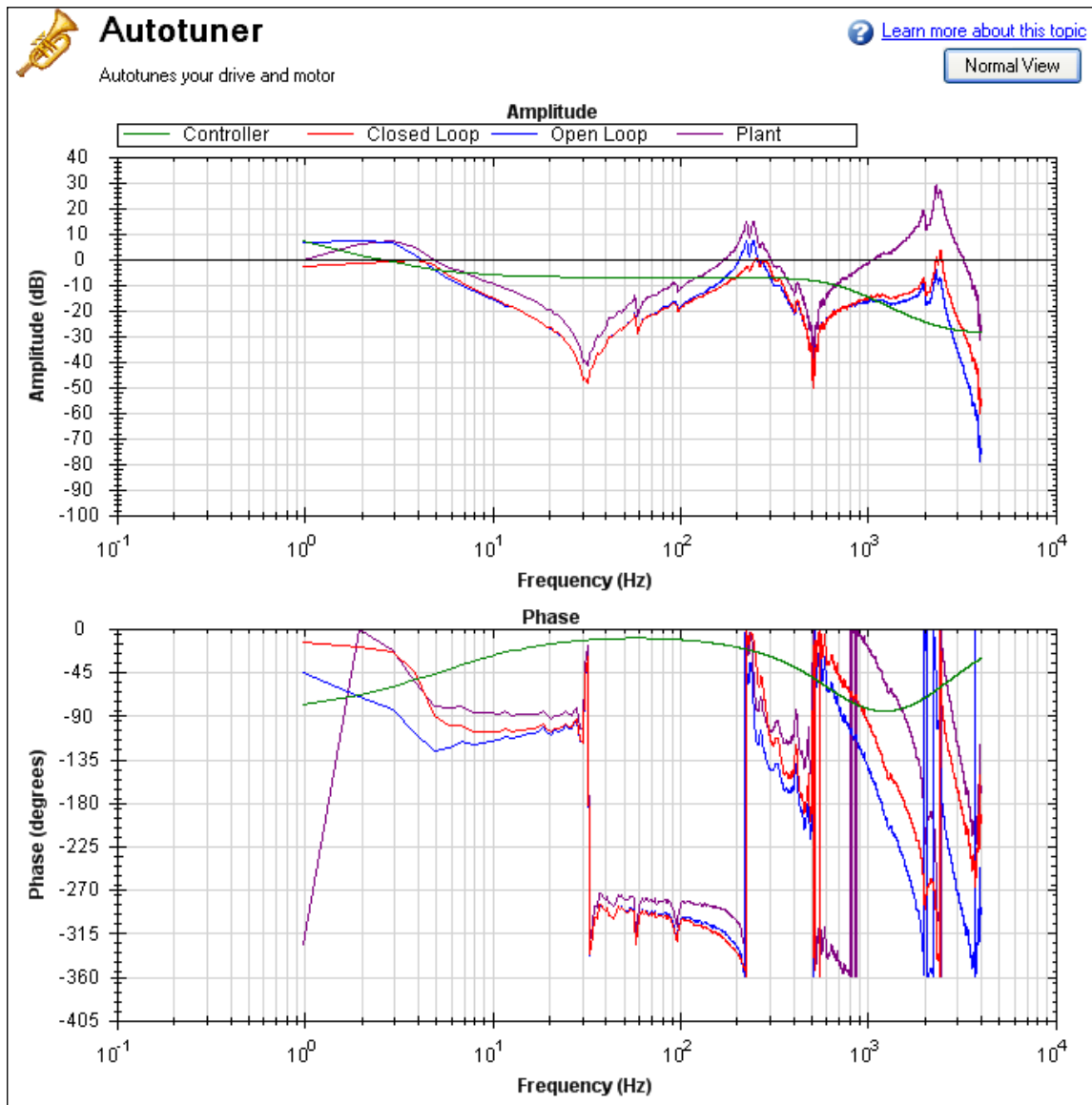

In addition, in order to accurately measure the low frequency resonances, the fast Fourier transform (FFT) resolution must be sufficiently fine to accurately measure the low-frequency resonance. A good place to start is to have an FFT resolution of 1/10 of the frequency of the lowest anti-node. In the case shown above, an anti-resonance of 30 Hz is present, so the resolution should be approximately 3 Hz FFT resolution. The PST can function with the resonance if it is accurately measured, as shown below. To adjust the FFT resolution, adjust **FFT Points** in the **Recording Options** tab as needed.

Autotuner	Measurement	Plots	Cursors
Current Amplitude: 0.095	Measurement: Closed Loop		
Velocity Amplitude: 3.063	Injection Point: Current		
Smoothing %: 1.000	Excitation Type: PRB		
FFT Points: 4096	Velocity Max: 1000.00 (RPM)		
Number Points: 60000	Excite Gap: 2		

Tuning Systems with High-Frequency Resonances

Some systems have resonances at very high frequencies (greater than 1 kHz). When the resonance is this large, it can prove a challenge in tuning, because these systems generate high noise levels that are often audible. An example of a large resonance is shown below. This example is from a steel flywheel mounted to an AKM 22E motor. The source of the resonance is the spring mass relationship between the motor rotor, shaft, and flywheel.

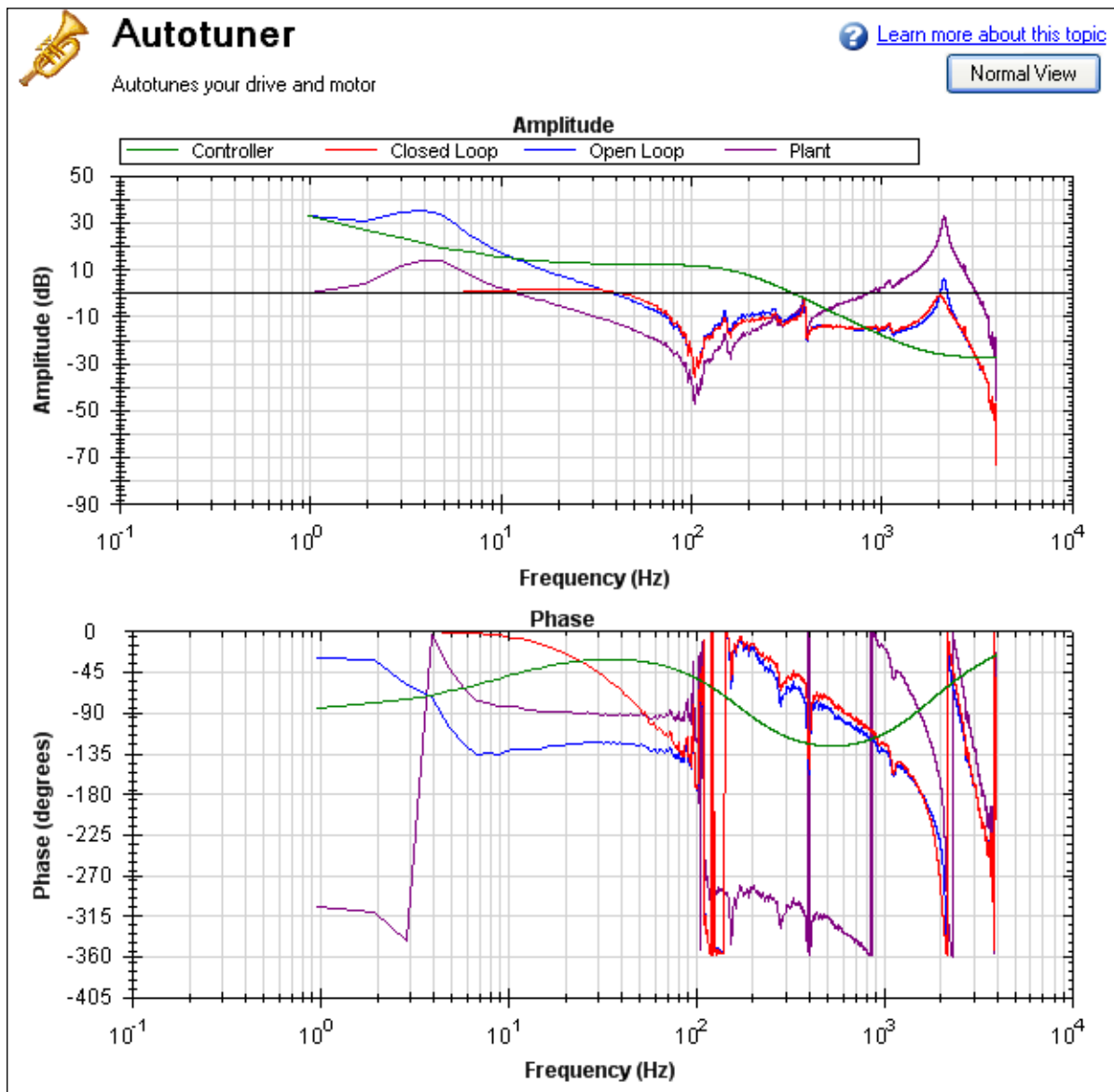

One way to resolve this problem is to use a low-pass filter in the feedback path. To use this filter, simply check the **Enable Lowpass Search** in the PST, which is the default behavior.

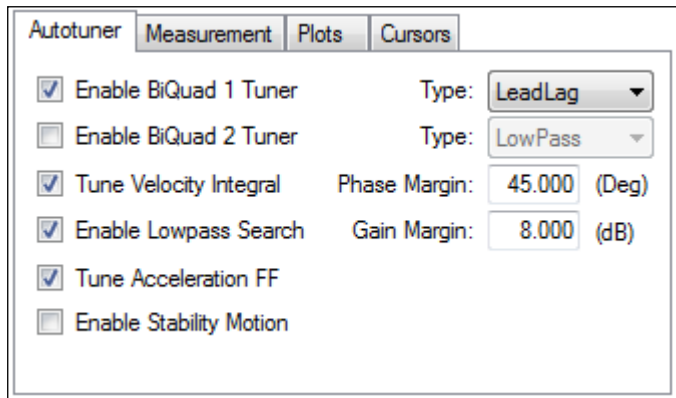

The screenshot shows the 'Autotuner' configuration window with the following settings:

Option	Type	Value	Unit
<input checked="" type="checkbox"/> Enable BiQuad 1 Tuner	LeadLag		
<input type="checkbox"/> Enable BiQuad 2 Tuner	LowPass		
<input checked="" type="checkbox"/> Tune Velocity Integral	Phase Margin:	45.000	(Deg)
<input checked="" type="checkbox"/> Enable Lowpass Search	Gain Margin:	8.000	(dB)
<input checked="" type="checkbox"/> Tune Acceleration FF			
<input type="checkbox"/> Enable Stability Motion			

Tuning systems with noisy frequency responses

When using a motor with a low-resolution incremental encoder or resolver, the high frequency response may be noisy. Below is a Bode plot created after autotuning of an incremental encoder with 8,192 counts per revolution.

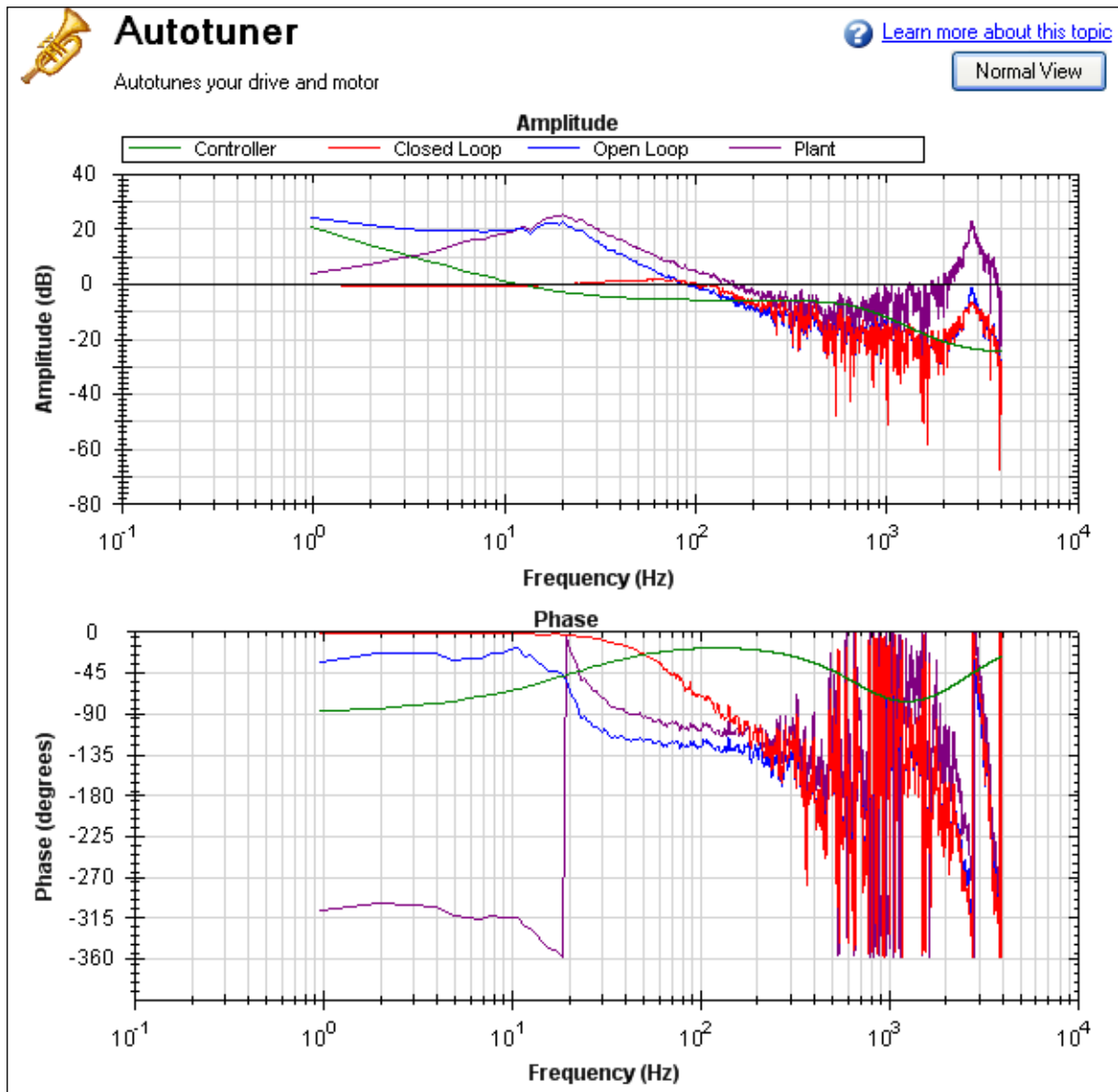

To make the Bode plot easier to read, increase the smoothing factor (1) in the advanced **Measurement Options**.

Autotuner	Measurement	Plots	Cursors
Current Amplitude:	0.095	Measurement:	Closed Loop
Velocity Amplitude:	3.063	Injection Point:	Current
Smoothing %:	4.000	Excitation Type:	PRB
FFT Points:	4096	Velocity Max:	1000.00 (RPM)
Number Points:	60000	Excite Gap:	2

After increasing the smoothing percentage, the Bode plot traces become cleaner and easier to read:

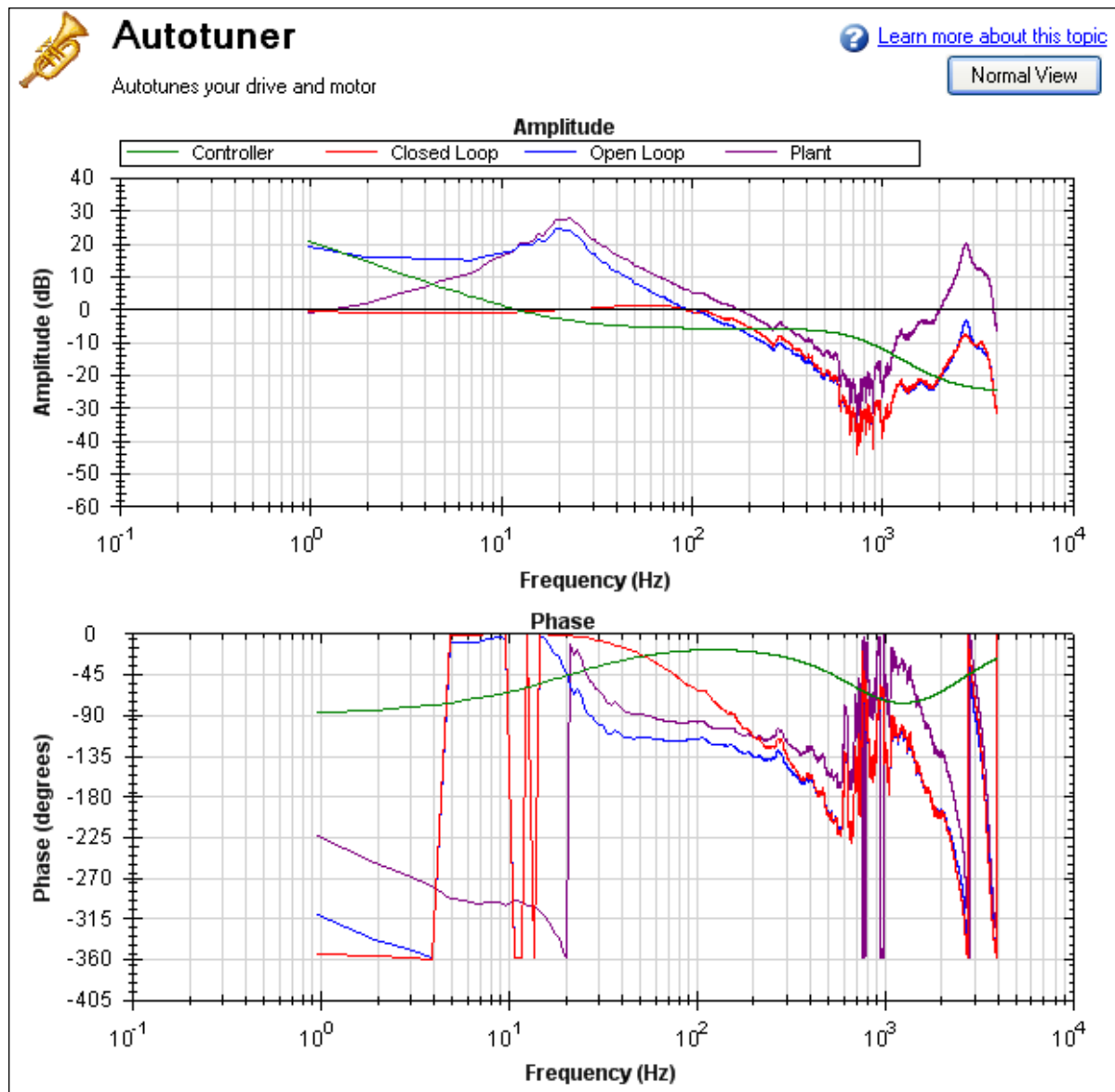

12.3.1.2 PST Options

When you click **More** in the PST view, the following options are displayed:

The screenshot shows the 'Autotuner' settings panel with tabs for 'Autotuner', 'Measurement', 'Plots', and 'Cursors'. The 'Autotuner' tab is active, displaying the following options:

- Enable BiQuad 1 Tuner Type: **LeadLag** (dropdown)
- Enable BiQuad 2 Tuner Type: **LowPass** (dropdown)
- Tune Velocity Integral Phase Margin: **45.000** (Deg)
- Enable Lowpass Search Gain Margin: **8.000** (dB)
- Tune Acceleration FF
- Enable Stability Motion

Enable BiQuad 1 Tuner

Check this box to use the first anti-resonance filter in the forward path (AR1). You can specify the type of filter to use in the **Type** box to the right of **Enable BiQuad 1 Tuner**.

Enable BiQuad 2 Tuner

Check this box to use the second anti-resonance filter in the forward path (AR2). You can specify the type of filter to use in the **Type** box to the right of **Enable BiQuad 2 Tuner**. Enabling this option may significantly slow your computer during this operation.

Biquad Type

For Biquad 1 and 2, you can choose what type of filter to implement. The four options are:

1. **LeadLag**: The LeadLag filter is the default, and will work for most servo systems.
2. **Lowpass**: A Lowpass filter requires the least amount of processing time. The PST will place the lowpass to get the maximum bandwidth possible.
3. **Resonator**: The Resonator filter is like a Notch filter with tunable bandwidth and notch depth. The Resonator takes longer to calculate than the LeadLag filter.
4. **Custom**: The Custom filter takes the longest to calculate and does not restrict the PST to a filter shape. This filter type provides excellent results, but may significantly slow your computer while the filter is calculated.

Tune Acceleration FF

This box turns on and off the acceleration feedforward tuner. If this box is checked, the PST will measure the inertia attached to the motor shaft, and using this measurement, will calculate an appropriate acceleration feedforward and write it to the drive (IL.KACFF (→ p. 543))

Enable Stability Motion

When this checkbox is checked, after the PST has completed, the PST will command a short move in the clockwise direction, then back to its origin and monitor the motor's parameters to determine if the tuning is stable. If an instability is detected, the drive will generate Fault F133 (→ p. 176): Instability during Autotune.

Phase and Gain Margins

The PST always ensures that the tuning satisfies stability criteria that can be adjusted in units of phase margin (in degrees) and gain margin (in dB). The PST uses default values for phase and gain margin, but you can adjust these values to ensure higher stability or to allow the PST to be more aggressive by using lower gain and phase margins.

Tune Velocity Integral

Check this box to tune VL.KI (velocity loop integral gain). If this box is unchecked, the PST will set VL.KI to zero.

Enable Low Pass Search

Check this to tune a fourth-order low pass filter in the feedback path (AR 3 and 4). If this box is unchecked, the PST will not modify the anti-resonance filters in the feedback path.

12.3.1.3 Measurement Options

The PST screen also provides options for measurements:

Autotuner	Measurement	Plots	Cursors
Current Amplitude:	<input type="text" value="0.095"/>	Measurement:	<input type="text" value="Closed Loop"/>
Velocity Amplitude:	<input type="text" value="3.063"/>	Injection Point:	<input type="text" value="Current"/>
Smoothing %:	<input type="text" value="1.000"/>	Excitation Type:	<input type="text" value="PRB"/>
FFT Points:	<input type="text" value="4096"/>	Velocity Max:	<input type="text" value="1000.00"/> (RPM)
Number Points:	<input type="text" value="60000"/>	Excite Gap:	<input type="text" value="2"/>

Current Amplitude

This box sets the amplitude of the current used to excite the system during a current injection mode excitation. This amplitude applies to all excitation types when the **Injection Point** is set to **Current**. The **Current Amplitude** box is disabled if the **Injection Point** is set to anything else.

Velocity Amplitude

This box sets the amplitude of the velocity used to excite the system during a velocity injection mode excitation. This amplitude applies to all excitation types when the **Injection Point** is set to **Velocity**. The **Velocity Amplitude** box is disabled if the **Injection Point** is set to anything else.

Smooth %

This value applies a moving average smoothing filter to the frequency response gathered during auto-tuning. This process reduces noise in the frequency response that can occur when making short frequency response measurements, using low resolution encoders, conducting low amplitude frequency response tests, or for other reasons. The smoothing filter iterates through each frequency on the FFT plot. For each frequency, all frequencies within the **Smooth %** range will have their magnitudes averaged.

For example, if you smooth a Bode plot with 5% smoothing, at 100 Hz, it will average all the values between 95Hz and 105Hz; when the filter gets to 1000 Hz, the filter will average all the values between 950 Hz and 1050 Hz.

As an example, assume a noisy sine sweep signal and use a 5% smoothing factor. Below is a noisy signal with a range of 100 Hz to 1000 Hz.

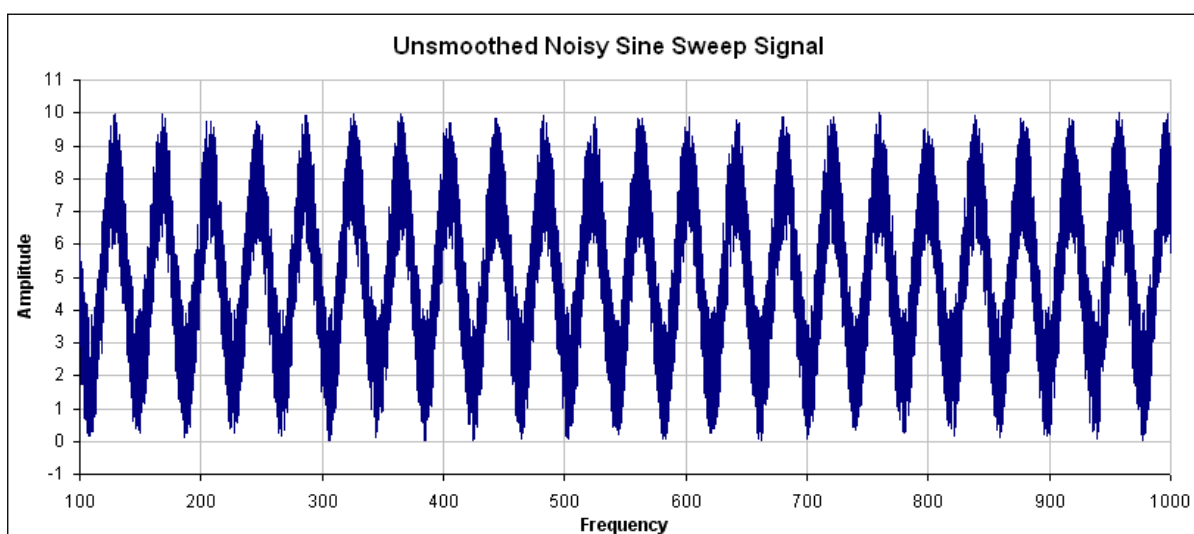

In this example, examining how the smoothing filter affects a single point shows how the smoothing filter works on a full plot. If you zoom in on 200 Hz +/- 5%, this gives a range of 190 Hz – 210Hz. The smoothing filter averages this range of values and puts the average right on 200 Hz. The figure below shows the zoomed data around 200 Hz and the averaged value of all frequencies +/- 5% (the red box illustrates the range of frequencies being smoothed).

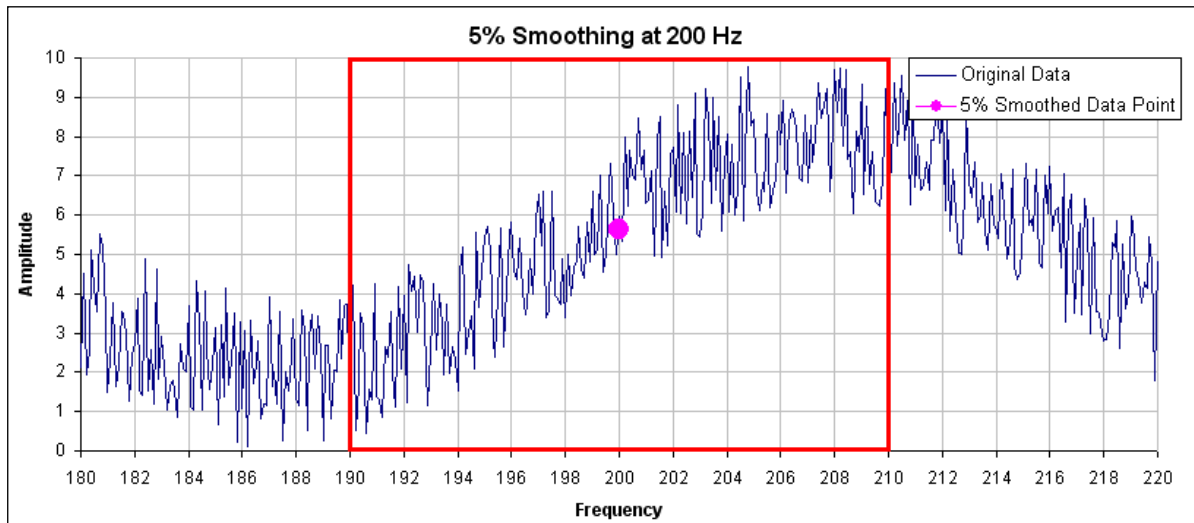

In the PST, the smoothing filter will do this analysis for every frequency point on the Bode plot. If the data is too noisy, then you can increase the smoothing percentage to smooth the noise out and see the underlying data patterns. A comparison of a system with 0.1% smoothing and 8% smoothing is shown below.

0.1% smoothing

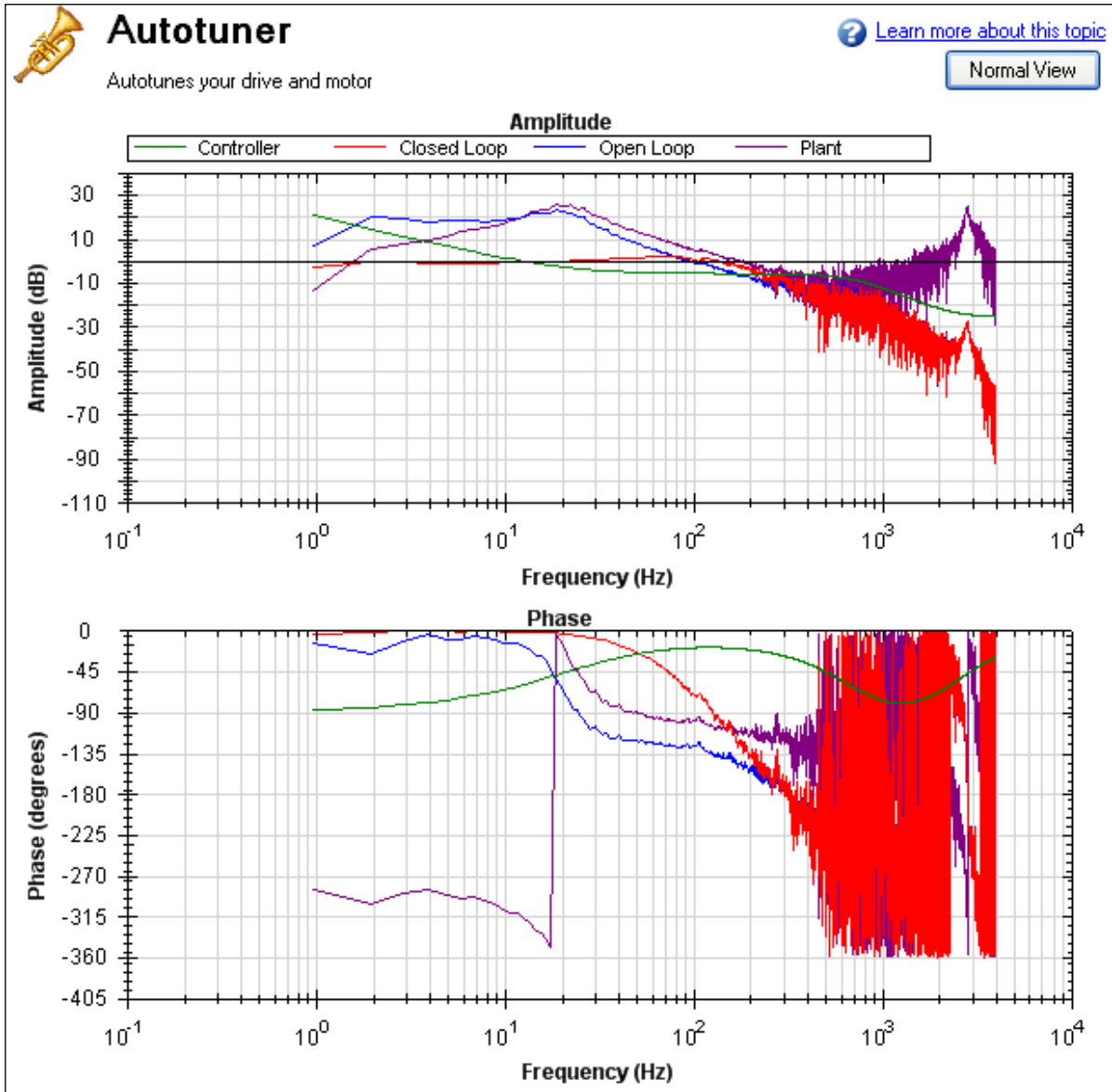

8% Smoothing

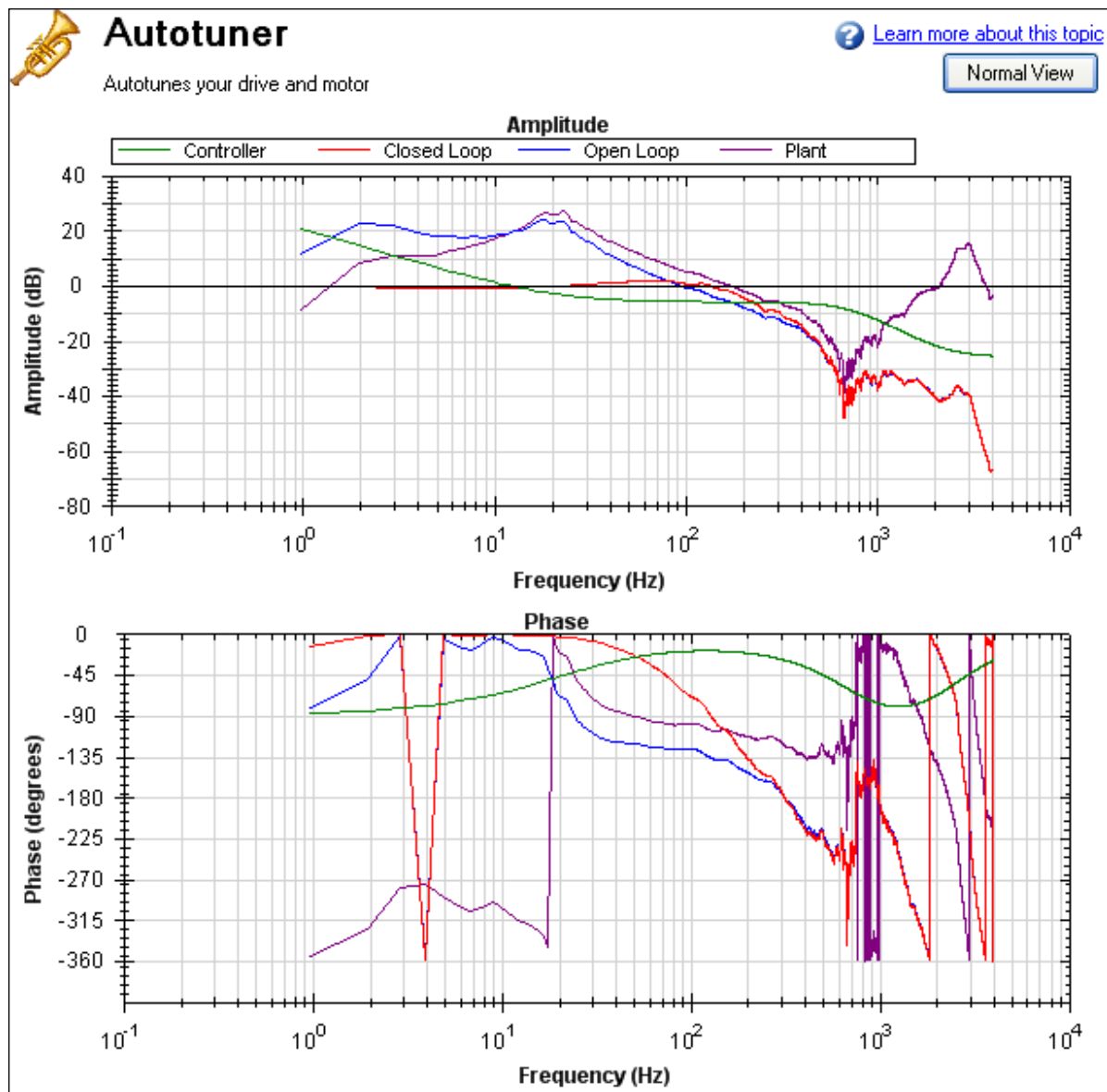

Note: Smoothing decreases the peaks of resonances; if smoothing is too high, a resonance may be completely hidden. If the PST cannot identify a resonance due to high smoothing, the system may become unstable.

Measurement

This box sets the measurement type used during a measurement. The PST functions only if **Plant** measurement is selected; autotune does not function in other measurement modes.

- **Closed Loop** directly measures the closed loop frequency response of the servo.
- **Plant** directly measures the plant, including drive, motor, and mechanics coupled to the motor.
- **Controller** directly measures the controller response, which includes the tuning in the velocity and position loops, and anti-resonance filters 1 & 2.

Injection Point

The **Injection Point** box sets the source location of the excitation used during autotuning. **Current** mode uses a torque disturbance at the torque output. During current injection point measurements, the excitation will use the **Current Amplitude** value to set the size of the excitation.

Velocity mode uses a velocity command to excite the system. During velocity injection point measurements, the excitation will use the **Velocity Amplitude** value to set the size of the excitation.

Excitation Type

The **Excitation Type** box allows you to choose the type of excitation. Noise, pseudo random binary (PRB), and sine are the options available.

- **Noise** uses a pseudo random noise signal to excite the system. The signal varies between +/- current or velocity amplitude (depending on injection point). The signal contains a frequency spectrum that goes from a lower limit equal to:

$16,000/(\text{Excite Gap} * \text{Number Points}) \text{ Hz}$

to a higher limit equal to:

$(16,000/\text{Excite Gap}) \text{ Hz}$

The richness of the frequency spectrum comes from variance in the amplitude of the noise signal.

- **PRB** uses a pseudo random binary signal to excite the system. The signal is either + or – current or velocity amplitude (depending on the injection point). The signal contains a frequency spectrum that goes from a lower limit equal to the larger of:

$(16,000/(2^{\text{BODE.PRBDDEPTH}} (\rightarrow \text{p. 290}) * \text{Excite Gap}))$ or $16,000/(\text{Excite Gap} * \text{Number Points}) \text{ Hz}$

to a higher limit equal to:

$(16,000/\text{Excite Gap}) \text{ Hz}$

BODE.PRBDDEPTH (\rightarrow p. 290) is set to 19 by the PST. The richness of the frequency spectrum comes from variance in the phase of the signal, not the amplitude.

- **Sine** requires that you specify the start frequency, end frequency, and frequency step size. The sine sweep takes significantly longer than a noise or PRB measurement, but is often cleaner. Be careful when selecting a step size: too large of a step size may miss important resonances, and too small of a step size increases measurement time.

FFT Points

The **FFT Points** box is only visible and applicable in noise and PRB measurements. **FFT Points** sets the resolution of the FFT's measurement. The frequency resolution is equal to

$16,000/(\text{Excite Gap} * \text{FFT Points})$

By increasing **FFT Points**, the resolution becomes finer, but noise in the frequency response increases.

Excite Gap

The **Excite Gap** box is only visible and applicable in noise and PRB measurements. This box sets how frequently the test excitation is updated. The excite gap minimum value is 1; this value is normally set to 2 for autotuning. The excite rate is $16,000/\text{gap}$. You can limit high frequency excitation by increasing the **Excite Gap** value.

Number Points

The **Number Points** box is only visible and applicable in noise and PRB measurements. This box sets the length of recording while measuring the frequency response of the system. The measurement length is:

$\text{Number Points} * \text{Excite Gap} / 16,000 \text{ seconds}$

Velocity Max

The **Velocity Max** box allows the user to specify the maximum velocity the motor should be able to move while performing excitation. This box is not in effect for normal drive operation; it is only visible during the PST excitation phases. This value is implemented as soon as the PST begins, and as soon as the PST is finished, the previous overspeed threshold (VL.THRESH (→ p. 731)) is restored.

Autotuner		Measurement		Plots		Cursors	
Current Amplitude:	0.095	Measurement:	Closed Loop ▼				
Velocity Amplitude:	3.063	Injection Point:	Current ▼				
Smoothing %:	1.000	Excitation Type:	Sine ▼				
Start Sine Freq:	1.000	Velocity Max:	1000.00 (RPM)				
End Sine Freq:	8000.0						Turn Sine On
Sine Step %:	6.000						
Current Freq:	0						

If **Excitation Type** box is set to **Sine**, different configuration options become available.

- **Start Sine Freq:** The Sine sweep test will begin at this frequency. The start frequency must be greater than zero and less than the end sine frequency. **Start Sine Freq** is only visible and applicable to Sine measurements.
- **End Sine Freq:** The Sine sweep test will end at this frequency. The end frequency must be less than or equal to 8,000, and more than the sine start frequency. **End Sine Freq** is only visible and applicable in Sine measurements
- **Sine Step %:** This box sets the sine step size. The sine sweep is discrete, not continuous. Each frequency is a multiple of the previous. For example, if the first frequency was 1 and the step size was 6%, the second frequency would be $1 * 1.06 = 1.06$ Hz, the third frequency would be $1.06 * 1.06 = 1.12$ Hz. This continues until the current frequency exceeds the **End Sine Frequency** value. **Sine Step %** is only visible and applicable in Sine measurements
- **Current Freq:** This field displays the current frequency of the sine sweep. **Current Freq** is only visible and applicable in Sine measurements
- **Turn Sine On:** This button allows the user to excite the system at a single sine frequency. When this button is pressed, it grays out boxes that do not apply. You may change the sine frequency and amplitude. To stop the sine excitation, click **Turn Sine Off**. **Turn Sine On** is only visible and applicable in Sine measurements.

Autotuner		Measurement		Plots		Cursors	
Current Amplitude:	0.095	Measurement:	Closed Loop ▼				
Velocity Amplitude:	3.063	Injection Point:	Current ▼				
Smoothing %:	1.000	Excitation Type:	Sine ▼				
Start Sine Freq:	1.000	Velocity Max:	1000.00 (RPM)				
End Sine Freq:	8000.0						Turn Sine On
Sine Step %:	6.000						
Current Freq:	0						

NOTE

When the sine excitation is used on low resolution encoders, high frequency excitation may cause

less than 1 count of encoder movement. If this occurs, no movement is detected on the motor for that excitation frequency. If this occurs, a data point for that frequency will not be plotted, as this results in a calculation of 0dB for gain and -infinity for phase.

12.3.1.4 Plot Options

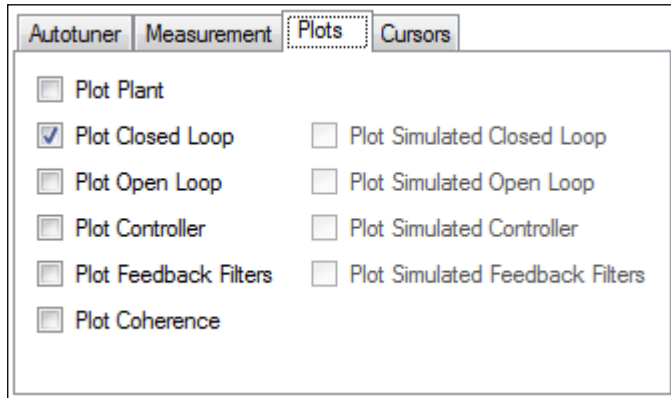

By default, only the measured closed loop plot is selected. You can control which of these responses are displayed on the Bode plot by checking or unchecking the **Plot Plant**, **Plot ClosedLoop**, **Plot Open Loop**, **Plot Controller**, and **Plot Coherence** checkboxes shown. The options **Plot Simulated Closed Loop**, **Plot Simulated Open Loop**, **Plot Simulated Controller**, and **Plot Simulated Feedback Filters** are only available in Bode plot mode, not PST mode.

Coherence

The coherence option is only available for noise and PRB measurements; it is not available for Sine excitation measurements.

Coherence is an indicator of how accurate your data is. For example, 0 dB (1 in linear numbers) means you have perfect coherence. Another way to think of this concept is that for one unit of input, you get one unit of output. Coherence is calculated as follows:

$$Coherence = \frac{(P_{xy} \times P_{xy}^*)^2}{(P_{xx} \times P_{xx}^*) + (P_{yy} \times P_{yy}^*)}$$

where:

P_{xx} = Power Spectral Density of Input signal

P_{yy} = Power Spectral Density of Output signal

P_{xy} = Cross Spectral Density of Input and Output

* designates complex conjugate

Cursors

Enabling cursors allows you to note specific points of interest on the Bode plot and create a table of reference points in the summary table. To enable cursors, choose Cursors from the Mouse Function drop-down(1).

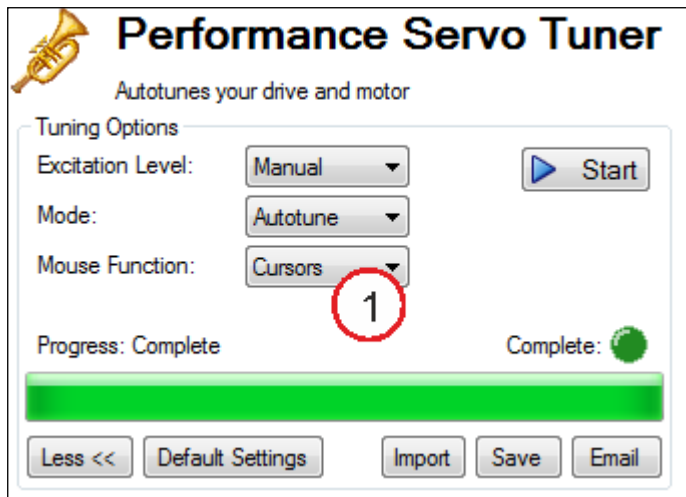

To move the cursor, move your mouse over the cursor in either the Amplitude (1), or Phase (2) plots, click and hold the left mouse button, and drag the cursor to a new location. Notice as you drag the mouse, the Frequency, Gain and Phase change in the summary window (3).

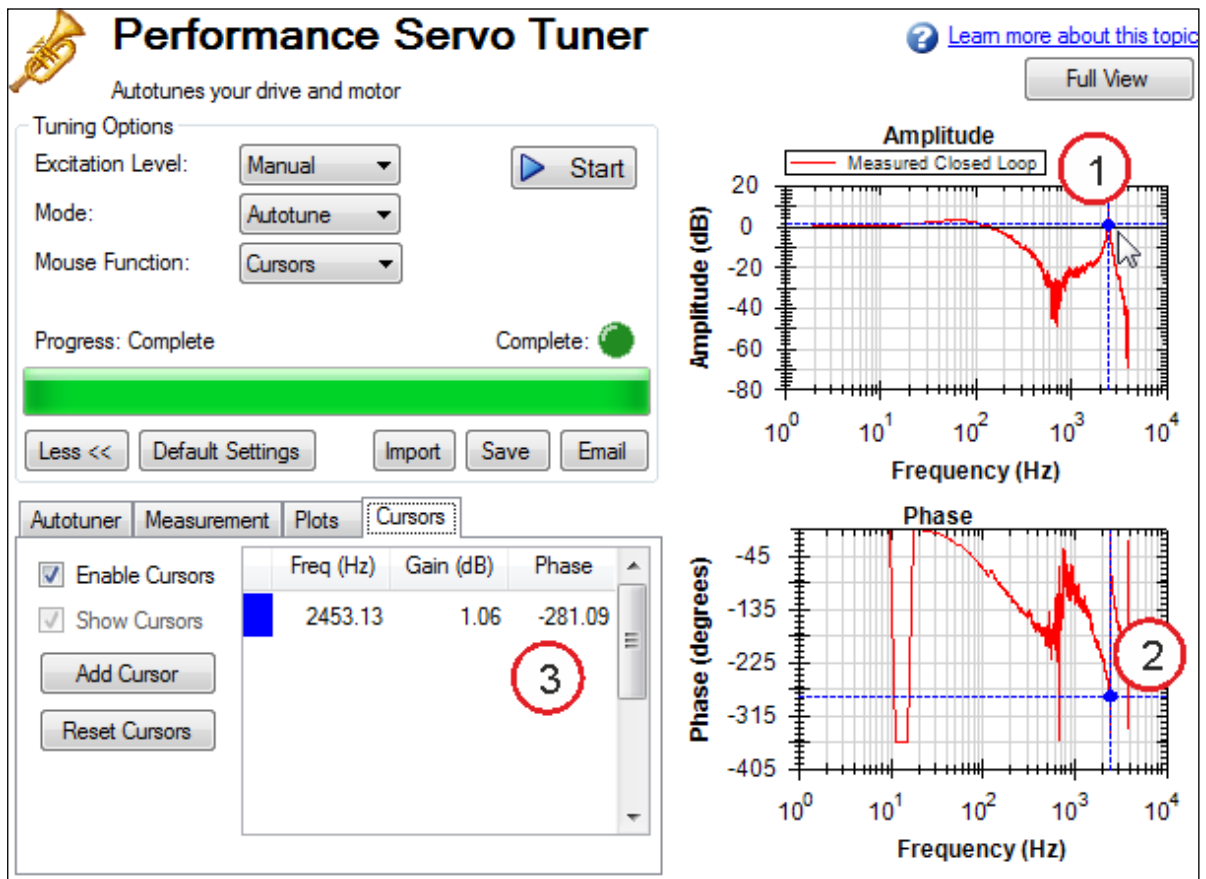

To add more cursors, click **Add Cursor**; you can add 10 cursors to the Bode Plot. When selecting a cursor, the cursor closest to the mouse will be selected. While dragging the cursor, the cursor will snap to the closest trace on the plot.

When cursors are enabled, zoom functions on the graph are disabled. To re-enable zooming, switch the Mouse Function to Zoom.

The dotted crosshair lines are only drawn for the active cursor selected; to remove all cursors from the screen, but retain their position, uncheck **Show Cursors** . To reset all cursors, click **Reset Cursors**.

Note: If a CSV file is saved or emailed after placing a cursor on the Bode plot, a cursor summary is included in the CSV raw data.

12.3.1.5 Resizing Bode Plots

In the PST view, the **Full View** and **Normal View** button (1) in the upper right of the window allows you to see the Bode Plot in greater or less detail. When viewing the Bode Plot in full view, the PST settings are hidden behind the Bode Plot. To access the PST settings, click the **Normal View** button in the upper right of the window.

Simple measurement normal view

Performance Servo Tuner
Autotunes your drive and motor

[Learn more about this topic](#) Full View

Tuning Options

Excitation Level: ▶ Start

Mode:

Mouse Function:

Progress: Complete Complete:

Less << Default Settings Import Save Email

Autotuner | **Measurement** | **Plots** | **Cursors**

Current Amplitude: Measurement:

Velocity Amplitude: Injection Point:

Smoothing %: Excitation Type:

FFT Points: Velocity Max:

Number Points: Excite Gap:

Amplitude

— Measured Closed Loop

Amplitude (dB)

Frequency (Hz)

Phase

Phase (degrees)

Frequency (Hz)

Simple measurement full view



Performance Servo Tuner

Autotunes your drive and motor

[Learn more about this topic](#)

Normal View

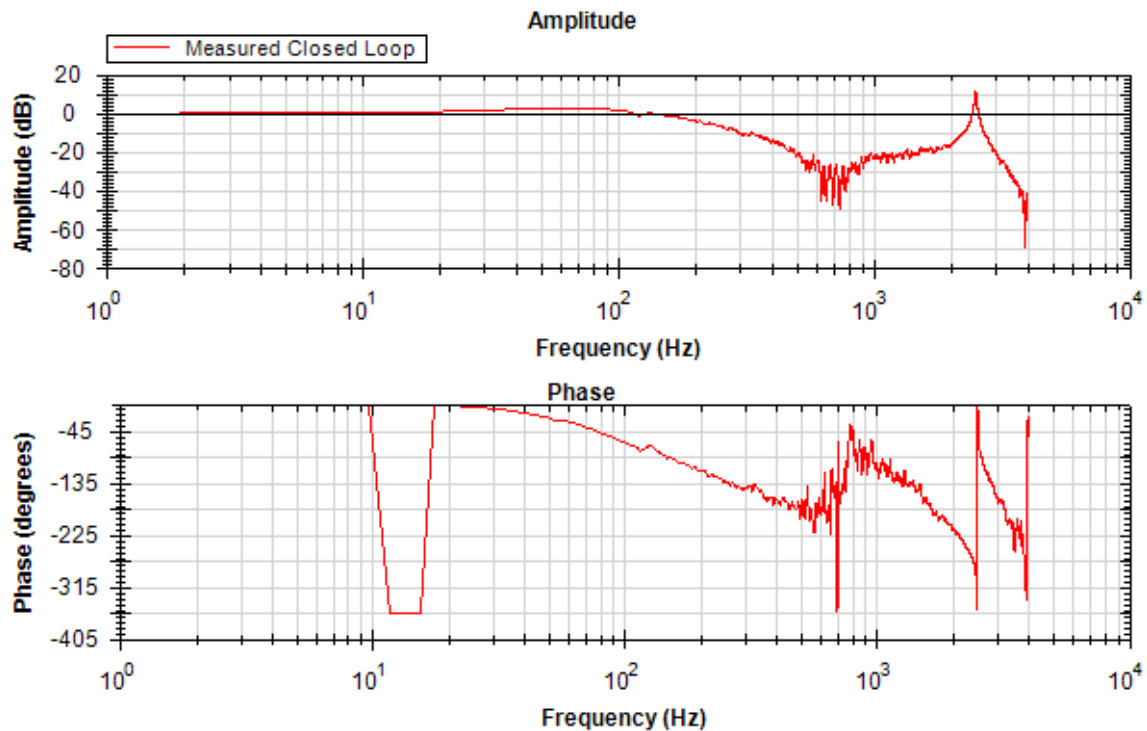

Reading and Understanding the Bode Plot

You can operate the PST without understanding how to read a Bode plot; however, understanding Bode plots will help you to use more advanced tuning techniques, which are covered more in depth in the Tuning Guide (→ p. 135) documentation.

Four Bode plot traces are displayed by default:

1. Controller (green): This trace represents the frequency response of the tuning in the velocity loop and position Loop, this trace also includes anti-resonance filter 1 and 2 (also referred to as [C]).
2. Closed loop (red): This trace shows the frequency response of $G/(1 + G * H)$ where $G = C * P$, and H is the frequency response of anti-resonance filters 3 and 4.
3. Open loop (purple): This trace shows the frequency response of $G * H$, where $G = C * P$, and H is the frequency response of anti-resonance filters 3 and 4.
4. Plant: This trace shows the frequency response of the mechanics of the drive and motor (also referred to as [P])

The diagram of the velocity loop on the drive below explains the frequency response that each of these traces represents: Tuning Guide (→ p. 135)

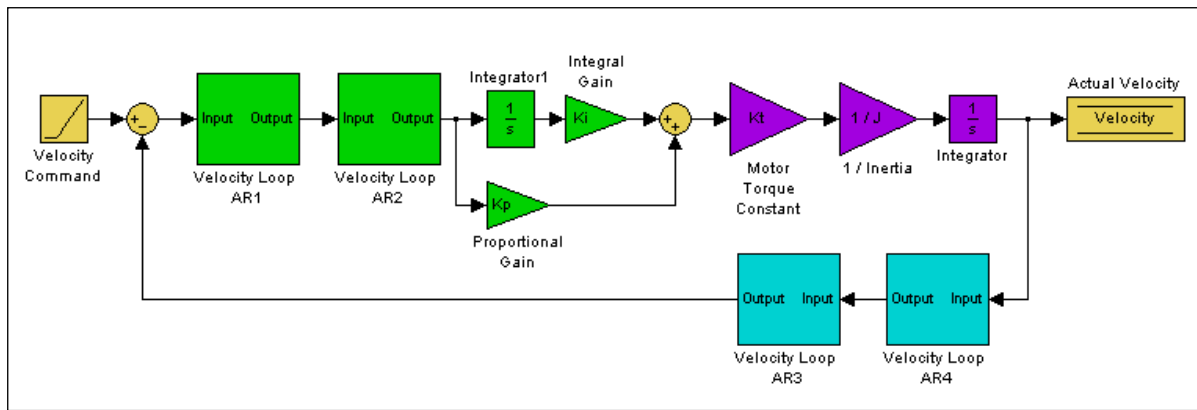

These blocks can be grouped into Controller, Plant, and Feedback sections:

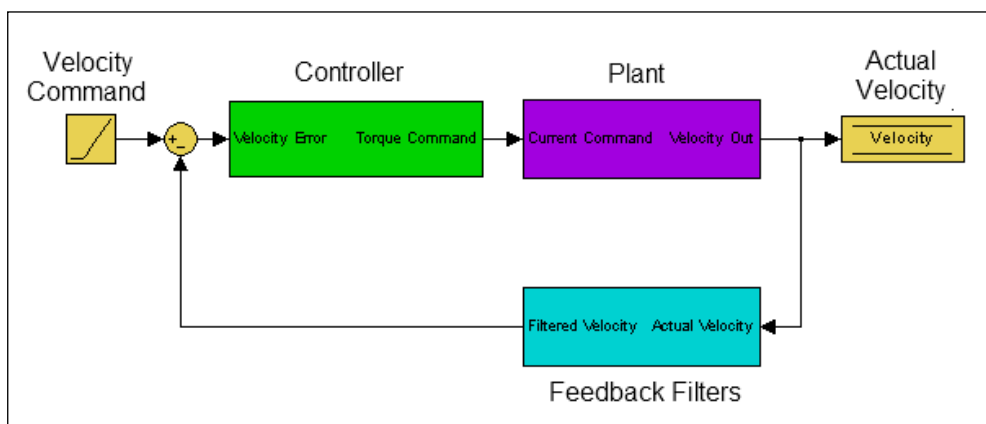

All of the green blocks have been grouped together to create the Controller [C]. The Controller is the portion of the control loop containing all velocity and position loop tuning, including the forward path filters.

All of the purple blocks have been combined to make the Plant [P]. The plant represents the mechanical and electrical properties of the motor, drive and any mechanical bodies attached to the motor.

The two feedback filters have been combined into one block. This value is never measured directly; however it contributes to both the Open Loop [G] and Closed Loop [T] frequency responses.

The definition of the Open Loop [G] frequency response is:

$$Open\ Loop = Controller \times Plant \times Feedback\ Filters$$

The definition of the Closed Loop [T] frequency response is:

$$ClosedLoop = \frac{Controller \times Plant}{1 + Controller \times Plant \times FeedbackFilters}$$

Below is a diagram of measurement points (input and output) for each of these frequency responses. The input and output markers have been color coded with the color they appear in the PST:

Current Excitation:

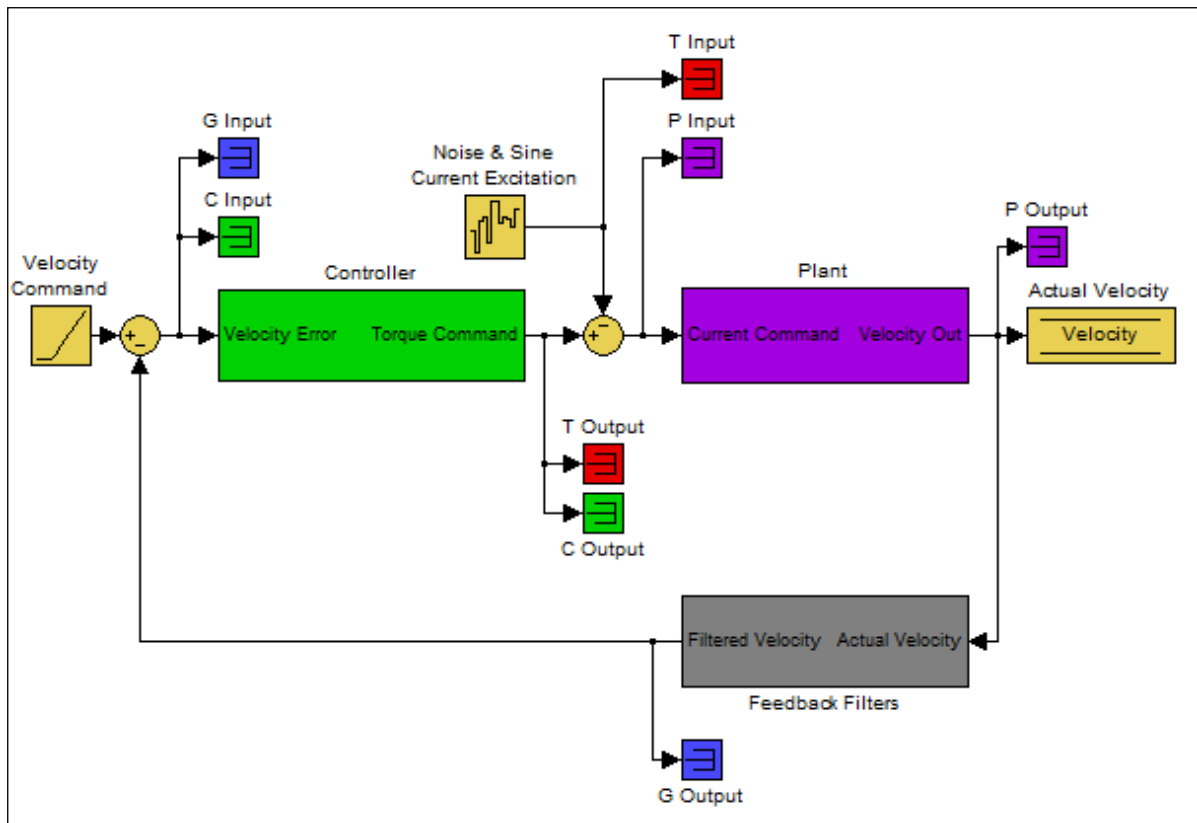

Velocity Excitation:

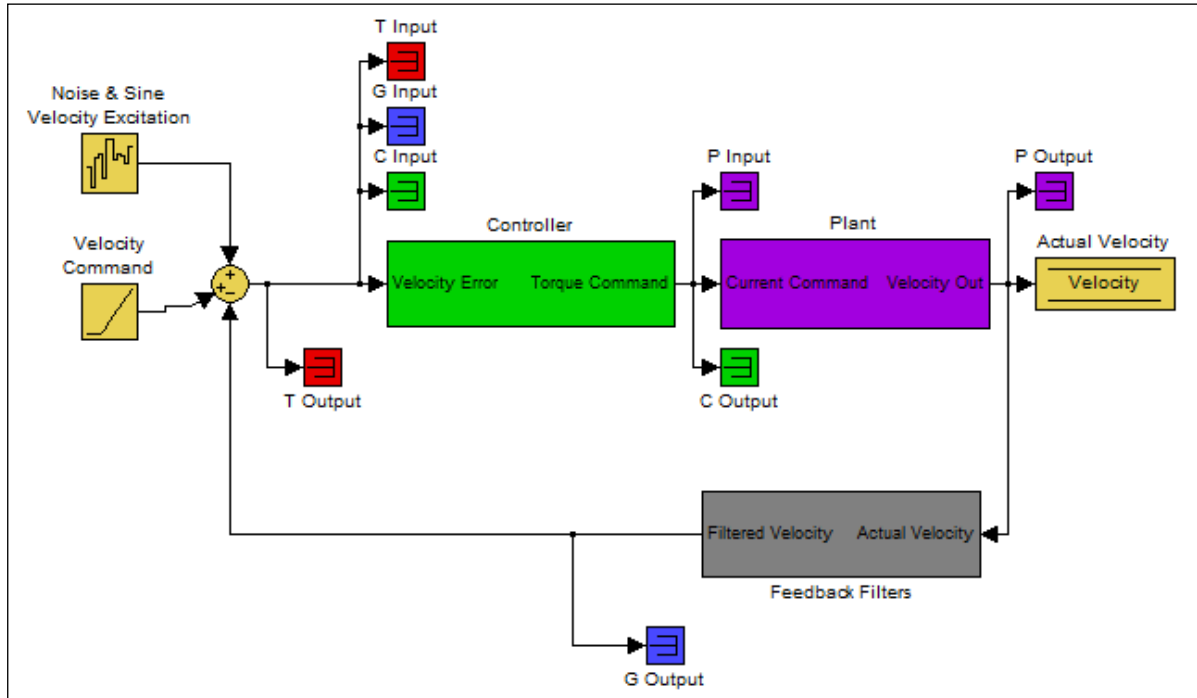

The resulting plots are the frequency response of output/input for each measurement.

For more information regarding these traces, please refer to the Tuning Guide (→ p. 135) documentation.

Below is a Bode plot of a motor with no load. The top plot is the magnitude plot (1); this plot shows the gain of the system with respect to frequency. This plot is often used to determine the bandwidth of the servo system.

The lower plot is the phase plot (2). This plot is used in conjunction with the magnitude plot to determine stability, and helps you to understand what kind of latencies exist in the servo system, or if latencies are induced by filters in the velocity loop.

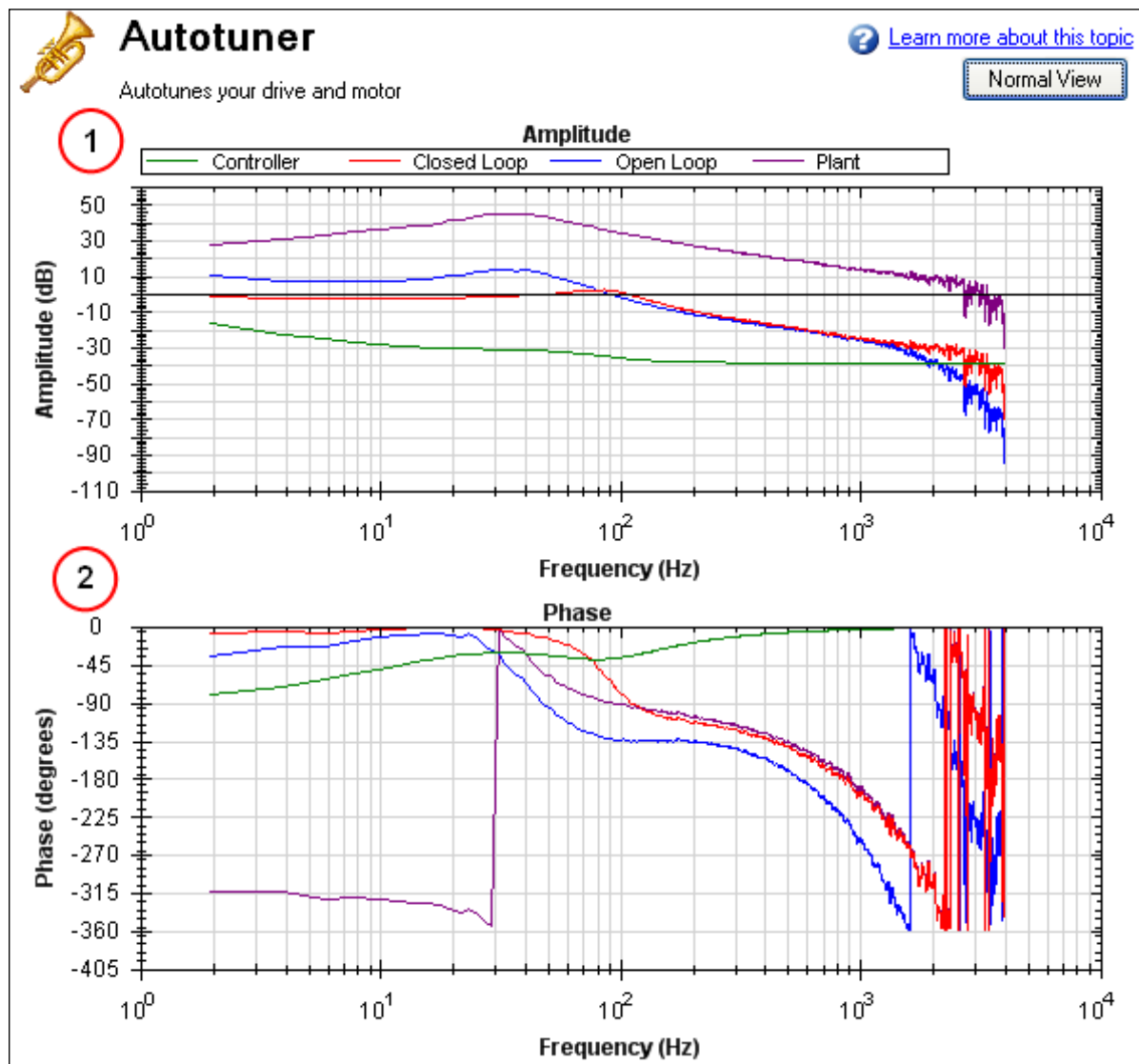

Using the Performance Servo Tuner to Manually Tune Systems

Often, you must manually adjust a control loop in order to obtain optimal machine performance. You can use the Performance Servo Tuner (PST) interface to tune your control loop for best performance. A powerful feature of the manual tuning interface is the ability to simulate the frequency response before it is measured. This feature allows the user to take a base measurement, disable the motor, adjust tuning parameters, and simulate the frequency response of the motor without taking a new measurement. This process saves time and protects equipment from dangerous oscillations.

To begin the manual tuning process, put the Performance Servo Tuner into Bode Plot mode.

Performance Servo Tuner

Autotunes your drive and motor

[Learn more about this topic](#)

Full View

Tuning Options

Excitation Level:

Mode: **1**

Mouse Function:

Progress: Complete Complete:

Measurement **Tuning** Plots Cursors

Current Amplitude: Measurement:

Velocity Amplitude: Injection Point:

Smoothing %: Excitation Type:

FFT Points: Velocity Max: (RPM)

Number Points: Excite Gap:

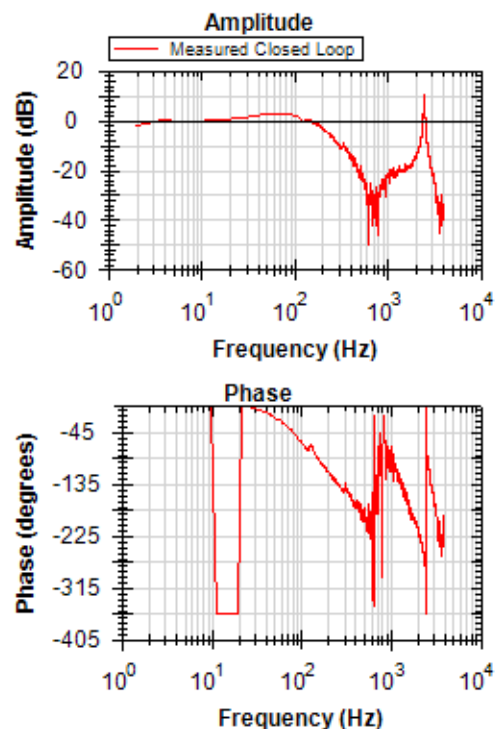

Several differences exist between PST and Bode Plot Interfaces:

- When the PST is put into Bode Plot mode, the **Autotuner** tab is removed from the advanced features, and replaced with a **Tuning** tab.
- The **Plots** tab unlocks simulated traces for closed loop, open loop, controller, and feedback filters.

Using the Tuning Simulation

To simulate tuning, there must be a valid Plant Plot in the PST (whether measured with a Bode Plot measurement or a full Autotune).

To selecting simulated plot traces, click on the **Plots** tab and check the following boxes:

Measurement **Plots** Tuning Cursors

Plot Plant

Plot Closed Loop Plot Simulated Closed Loop

Plot Open Loop Plot Simulated Open Loop

Plot Controller Plot Simulated Controller

Plot Feedback Filters Plot Simulated Feedback Filters

Plot Coherence

These selected boxes are the most common configuration for tuning; however, simulation will occur regardless of the checkboxes selected .

The boxes on the left plot the existing frequency response of the drive based on the tuning parameters that are loaded. The boxes marked "Simulated" (on the right) use the plant data from the measurement and the tuning parameters in the PST to simulate the performance of those tuning parameters without loading them to the drive.

Using the Performance Servo Tuner Manual Tuning Interface

To use the PST manual tuning interface, click on the **Tuning** tab.

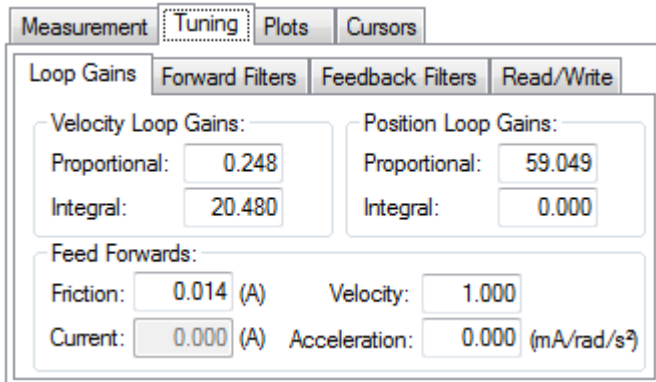

This tuning interface loads the tuning parameters on the drive each time a measurement is taken. Tuning parameters are split up into Loop Gains (Velocity Loop, Position Loop), Forward Path Biquad Filters, and Feedback Path Biquad Filters.

After modifying tuning gains, you must click on the **Read/Write** tab and click the **Write Tuning** button.

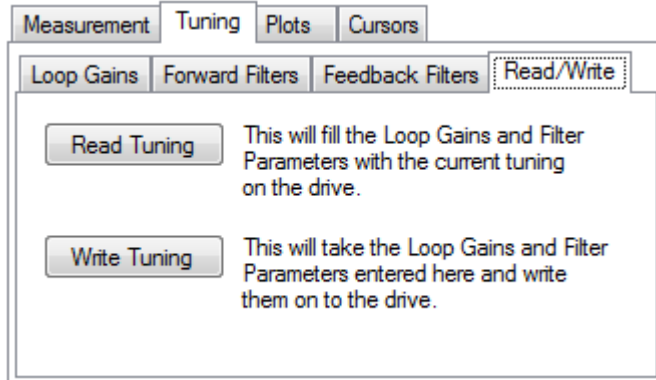

To restore the tuning on the drive to the PST interface, click the **Read Tuning** button.

Note: If tuning gains are modified and a Bode Measurement is made without clicking the **Write Tuning** button, the PST will overwrite the tuning gains in the interface with the tuning parameters on the drive.

Simulating Modified Loop Gains with the Performance Servo Tuner

Here is the frequency response of a test system after using the PST.

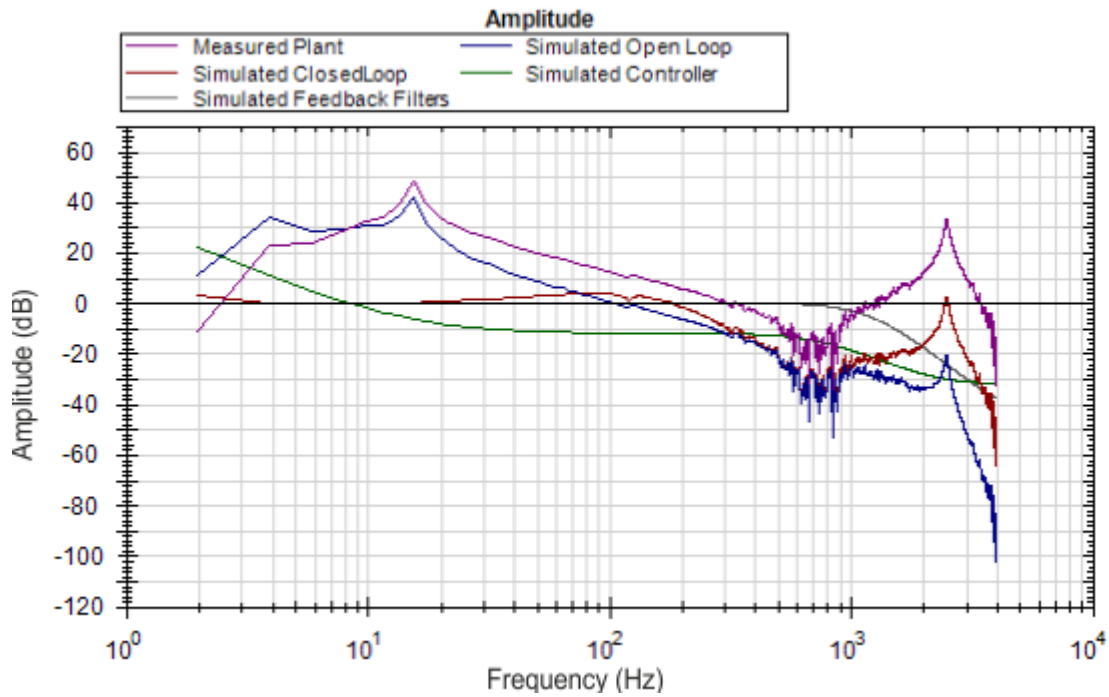

The Velocity Loop Proportional gain here is 0.248. If an application did not need to be tuned as stiff as this, then you could use the PST simulator to detune the motor to the desired bandwidth. A followup Bode Measurement can verify that the simulated response is correct.

Use the boxes in the **Loop Gains** tab to change tuning gains until the desired frequency response is achieved.

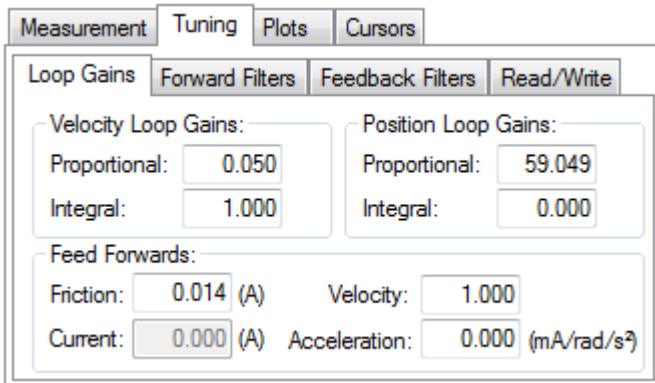

The de-tuning of velocity loop proportional and integral gains simulated that the bandwidth of the servo has been detuned from ~100 Hz to ~30 Hz.

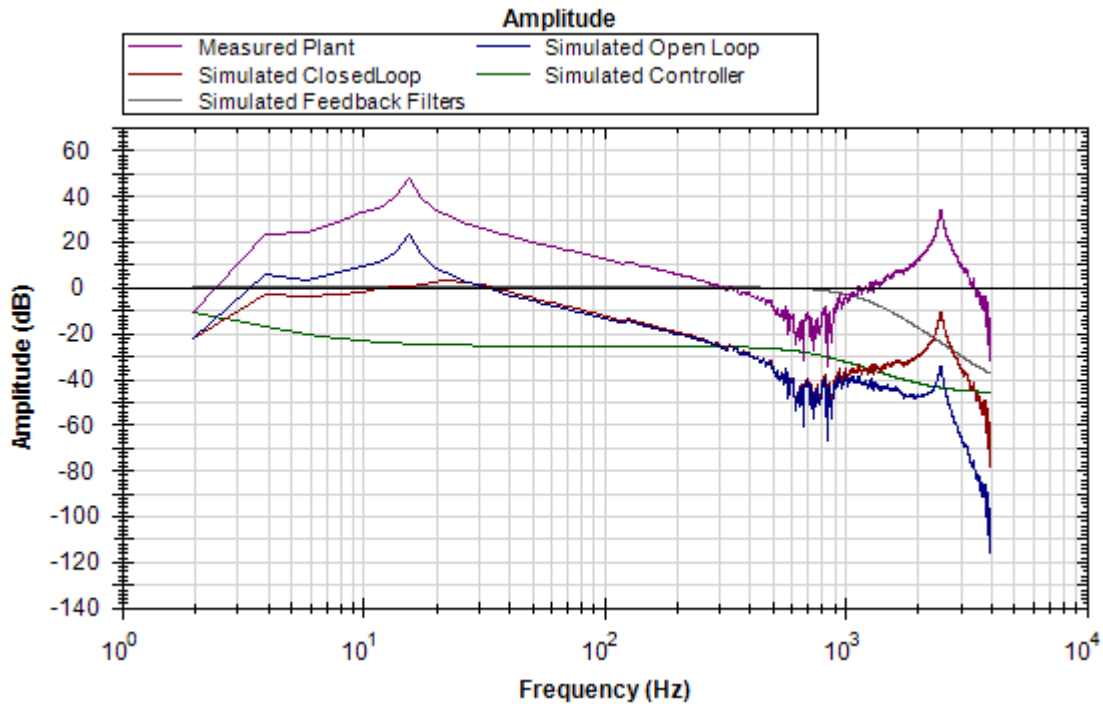

Next, write the tuning parameters to the drive using the **Write Tuning** button on the **Read/Write** tab.

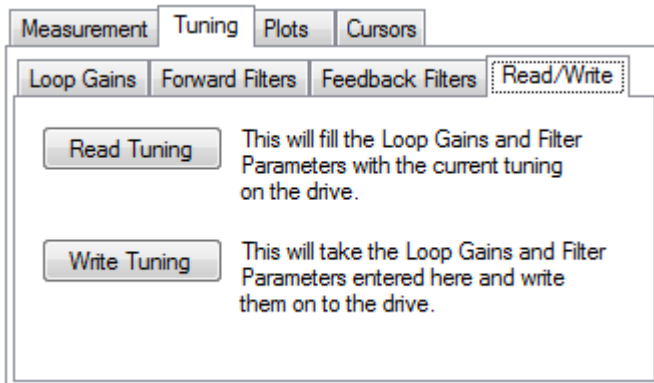

Now, complete a Bode Plot measurement to compare the simulated result with the new measured result.

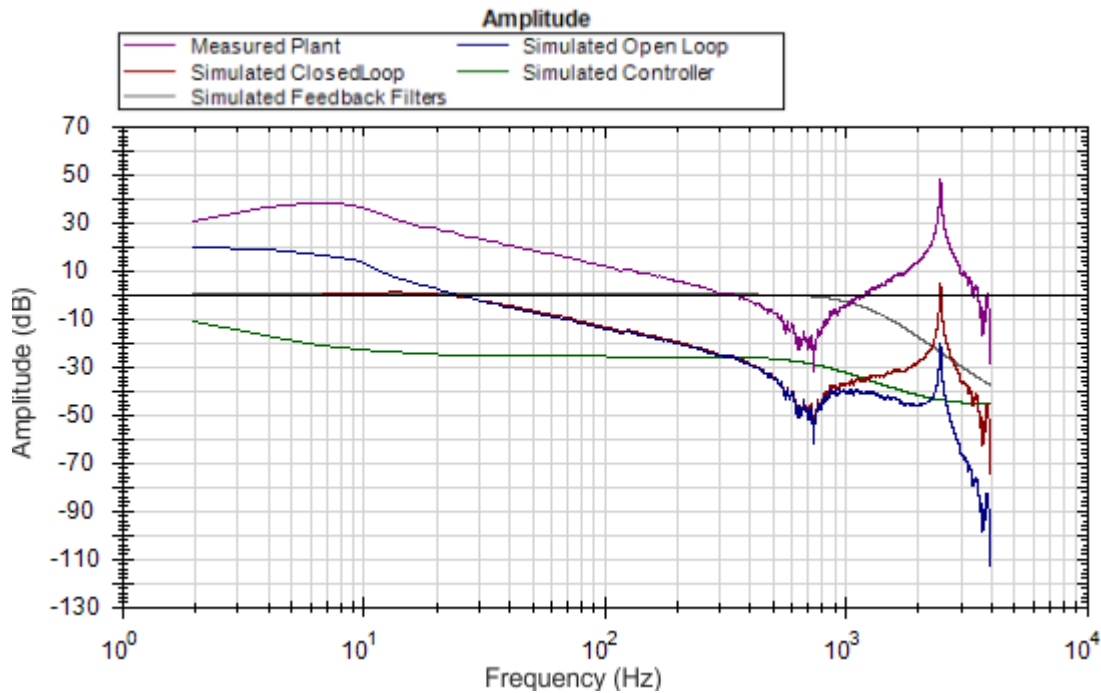

The new measured Bode Plot indicates we achieved slightly lower than 30 Hz bandwidth. The servo is stable, and tuning can be refined until desired performance is reached.

Simulating Filters with the Performance Servo Tuner

Resonances add many challenges to tuning a servo. Using the correct filter in an application can greatly improve system performance when resonances are present.

The Bode plot in this example shows a sharp, high-magnitude resonance at 2500 Hz. Because this is the only resonance, this is an indicator that a resonator (a tunable notch) filter may increase performance.

Click on the **Forward Filters** tab:

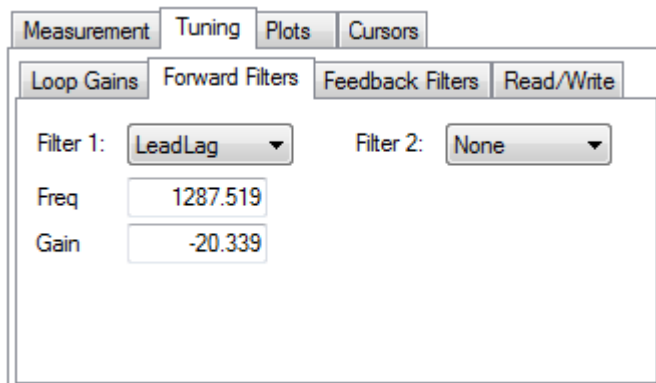

The results of the autotune are still on the drive, and provide adequate tuning. A lead lag filter is the default tuning filter, and is a good general case filter for most servo loops.

Because this test fixture has such a prominent single resonance, we can improve performance (and reduce noise) by placing a notch filter at this resonance.

By tuning a Resonator to best cancel the resonance in the plant, the resonance in the open loop, and therefore the closed loop can be minimized.

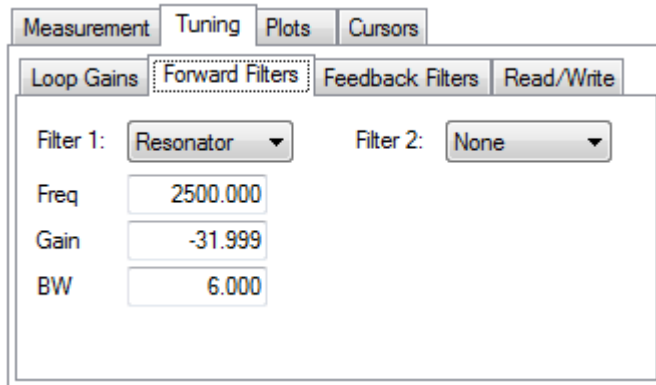

The resulting frequency response using the above resonator configuration is shown below:

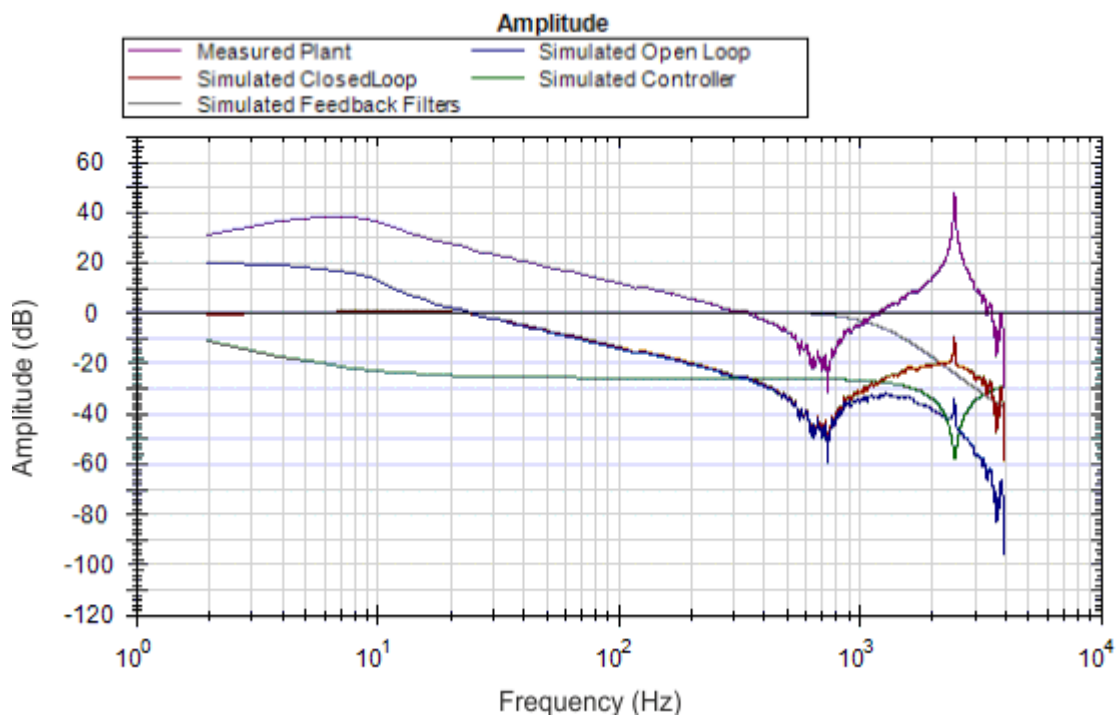

Notice the attenuation of the resonance in the blue and red traces (open loop and closed loop, respectively).

Using Filters to Reduce Noise

To reduce noise, it is best to place filters in the feedback path. This placement attenuates the noise resulting from a noisy encoder being amplified by the current loop. This noise can be filtered by a forward path filter, however if a filter is placed in the forward path that introduces phase lag (like a lowpass), then your motion profile will exhibit that phase lag in the command signal. If the filter is placed in the feedback path, this lag will be avoided.

12.4 Tuning Guide

12.4.1 Overview

This section covers tuning the velocity and position loops in the AKD PDMM. Servo tuning is the process of setting the various drive coefficients that are needed for the drive to optimally control the servo motor for your application. There are different ways to tune, and several are covered here. We will give you guidance on what the different methods of tuning are and when to use them.

The AKD PDMM works in three major operation modes: torque, velocity, and position operation mode. No servo loop tuning is required for torque mode. Velocity loop and position loop tuning are covered below.

The AKD PDMM has an auto tuner that will provide the tuning that many applications will need. This section describes the tuning process and how to tune the AKD PDMM, specifically for cases where the user does not want to use the auto tuner.

Tuning in this section will focus on tuning in the time domain. This means that we will look at the velocity or position response vs. time as the criteria we use to decide how well tuned a control loop is tuned.

12.4.2 Determining Tuning Criteria

Choosing the proper specifications for a machine is a prerequisite for tuning. Unless you have a clear understanding of the type of performance needed to push the machine into production, the tuning process will cause more problems and headaches than it solves. Take time to layout ALL the requirements of the machine—nothing is too trivial to consider.

- Determine what the most important criteria are. The machine was likely designed and developed with a certain performance in mind. Include ALL performance criteria in the specification. Do not concern yourself with whether or not the criteria sound scientific. (i.e. If the motion needs to visibly look smooth, put it in the specification. If it can't have any noise, put it in the specification.) At the end of the development phase, the machine's performance should match the performance previously set in the specification. This will ensure that the machine meets its performance goals and that it is ready for production.
- Test the machine with realistic motion. Do not simply tune the machine to make short linear motion, when it will make long, s-curve motions in the real world. Unless you test the machine with realistic motion, there is no way to determine if it is ready for production.
- Determine some specific, quantitative criteria for identifying unacceptable motion. It's better to be able to tell when a motion is unacceptable than to try and figure out the exact point where acceptable motion becomes unacceptable. Here are some examples of motion criteria:
 1. +/- x position error counts during the entire motion.
 2. Settling within +/- x position error counts, within y milliseconds.
 3. Velocity tolerance of x% measured over y samples.
- It is important to focus on the things that will get the machine into production with reliable performance, based on a fundamental understanding of the system.

After you have constructed a detailed servo performance specification, you are now ready to start tuning your system.

12.4.3 Before You Tune

In the worst case, if something goes wrong during tuning, the servo can run away violently. You need to make sure that the system is capable of safely dealing with a servo run away. The drive has several features that can make a servo run away safer:

- Make sure that the limit switches turn the drive off when tripped. If a complete run away occurs, the motor can move to a limit switch very quickly.
- Make sure the max motor speed is set accurately. If a complete run away occurs, the motor can reach max speed quickly and the drive will then disable.

12.4.4 Closed Loop Tuning Methods

The closed loop control loop is responsible for the desired position and / or velocity (trajectory) of the motor and commanding the appropriate current to the motor to achieve that trajectory. The challenge in

closed loop control loops is to make a system that not only follows the desired trajectory, but also is stable in all conditions and resist external forces, and do all of this at the same time.

When in velocity operation mode, only the velocity loop is tuned. When in position operation mode, both the velocity and position loops must be tuned.

12.4.4.1 Tuning the Velocity Loop

The velocity loop on the AKD PDMM consists of a PI (proportional, integral) in series with two anti-resonance filters (ARF) in the forward path and two anti resonance filters in series in the feedback path.

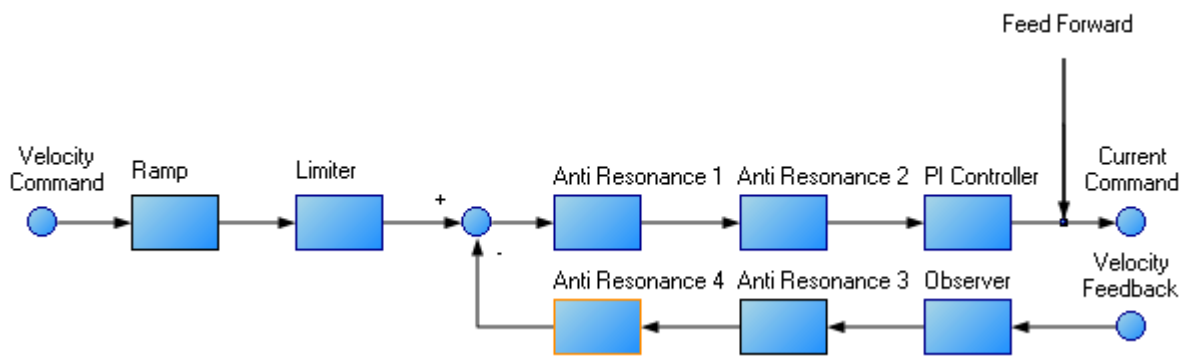

To perform basic tuning of the velocity loop, you can use just the PI block and set ARF1 and ARF2 to unity (no effect) and set the observer to 0 (no effect). Using just the PI block simplifies the process of tuning the velocity loop. To start tuning you can adjust the PI Controller block first. A simplified velocity loop without anti-resonant filters and observer is shown below. This is how you can think of the loop before the anti resonant filters and observer is used.

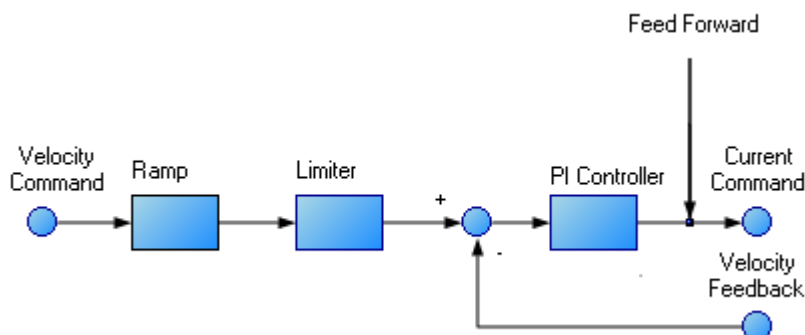

Procedure for simple velocity loop tuning:

1. Set DRV.OPMODE to velocity or position, as appropriate for your application. If DRV.OPMODE is set to position, set VL.KVFF to 1.0.
2. Set VL.KP to 0.
3. Set VL.KI to 0.
4. Set service motion to make a motion that is similar to the move speeds that will be used in the real application. Do not set the service motion to a speed higher than $\frac{1}{2}$ of the maximum motor speed, to allow for safe overshoot during tuning. Set acceleration to an appropriate value for your application. Set service motion to reversing. Set time1 and time2 equal to 3 times the expected settling time for the system. 1.0 second is a reasonable value for time1 and time2, if you don't know the expected settling time.

5. Enable the drive and start the service motion. You should see no motion, as there are no velocity loop tuning gains at this point.
6. When adjusting VL.KP and VL.KI, below record VL.FB and VL.CMD. These are the traces that are used to determine the performance of the velocity loop.

Channels							Time-base and Trigger	Service Motion	Servo Gains	Observer	All Gains	AR F
Id	Source	Color	Hide	Y Axis	Filter	Filter Frequen...						
1	Current feedback (IL.FB)	Red	<input type="checkbox"/>	Current	<input type="checkbox"/>	400						
2	Velocity command (VL.CM...)	Green	<input type="checkbox"/>	Velocity	<input type="checkbox"/>	400						
3	Velocity feedback (VL.FB)	Blue	<input type="checkbox"/>	Velocity	<input type="checkbox"/>	400						
4	None	Purple	<input type="checkbox"/>	Default	<input type="checkbox"/>	400						
5	None	Orange	<input type="checkbox"/>	Default	<input type="checkbox"/>	400						
6	None	Yellow	<input type="checkbox"/>	Default	<input type="checkbox"/>	400						

Idle

Stop Motion

Enable Drive

Start Recording

Refresh

7. Adjust VL.KP. Keep increasing VL.KP by a factor of 2 until you either:
 - o Hear an objectionable noise from the system (buzzing, humming, etc) or
 - o See velocity overshoot. No velocity overshoot should be present when using only VL.KP.
 - o When you reach one of the limits above, decrease VL.KP to the value where there were no objectionable noises or overshoot.
8. Adjust VL.KI. Increase VL.KI by a factor of 1.5 until you either:
 - o Hear or see objectionable noise or shuddering from the system
 - o See > 15% overshoot
 - o Here is an example of 15% overshoot. This is zoomed in view of a service motion commanded to 1000 RPM (location 1), where the overshoot peaks at 1150 RPM (location 2).

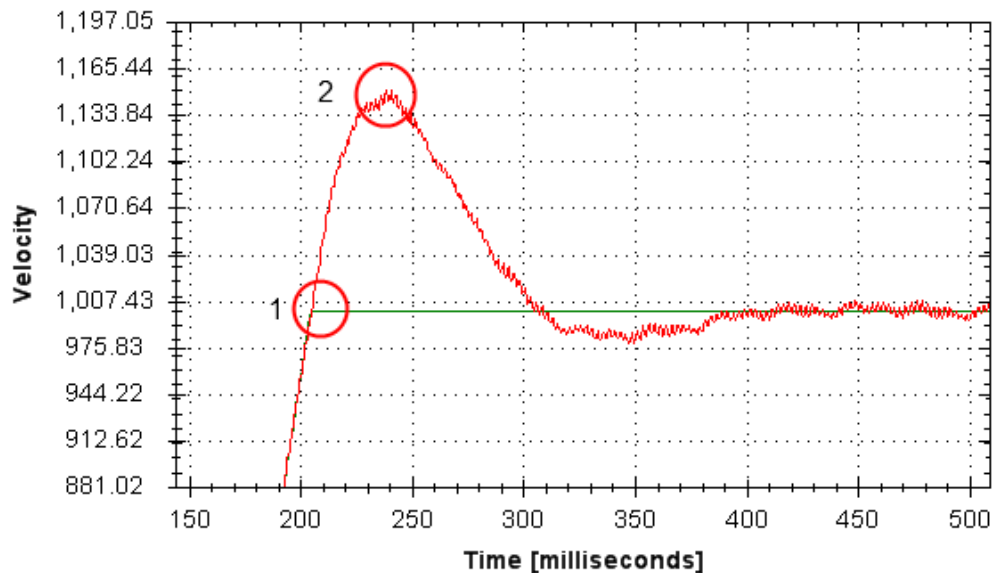

- Here is an example of 11 overshoots. Each overshoot is shown by a red circle.

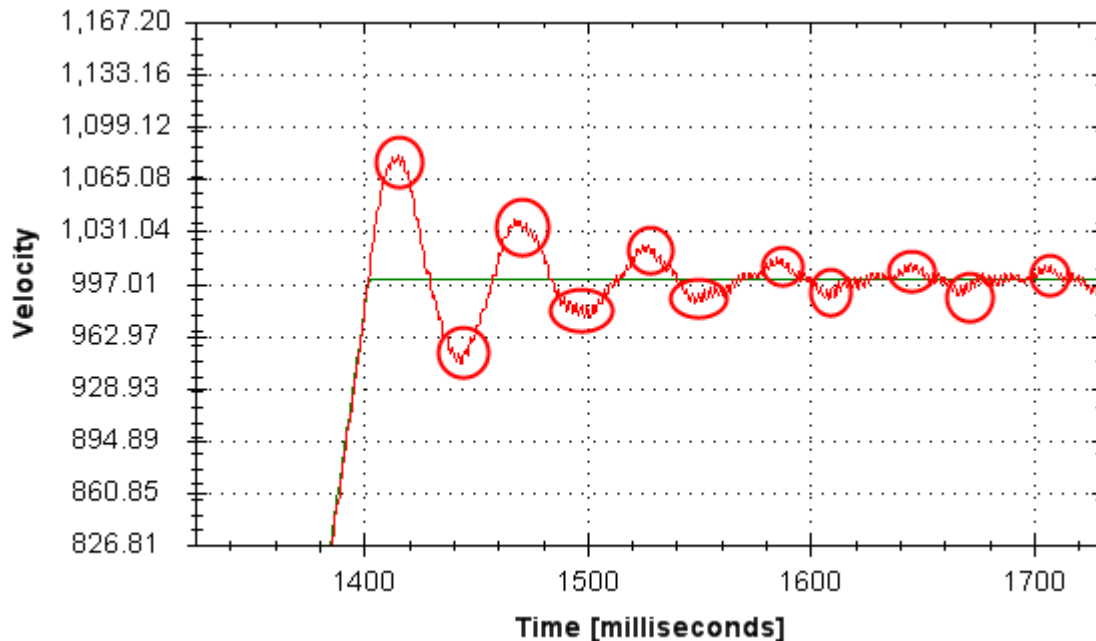

- When you reach one of the limits above, decrease VL.KI to the value where there were no objectionable noises or overshoot.

9. Stop the service motion

12.4.4.2 Tuning the Position Loop

The position loop is a second loop that builds upon a correctly tuned velocity loop to provide accurate control over position. The position loop is a simple element that consists of a PI loop. It is simplest to tune the P and I terms in the velocity loop and use only the P term in the position loop.

At most, use only three non-zero P and I terms from both the velocity loop and the position loop. One combination would be VL.KP, VL.KI, and PL.KP. Another valid combination would be VL.KP, PL.KP, and PL.KI. The VL.KP, VL.KI, and PL.KP combination is shown here.

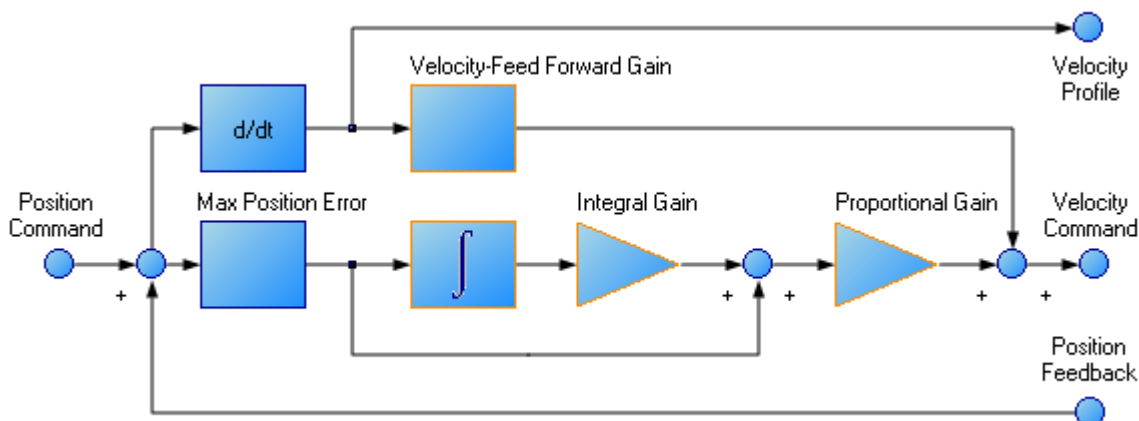

Procedure for tuning position loop:

- Set VL.KVFF to 1
- Increase PL.KP until either:

- You see 25% overshoot, or
- You see > 3 overshoots, or
- You hear objectionable noises from the system.
- When you reach one of the limits above, decrease PL.KP to the value where there were no objectionable noises or overshoot.

12.4.5 Torque Feedforward Tuning Methods

The torque based feedforward terms on the AKD PDMM effectively model the physics of your motor and allow the drive to command the appropriate current, even before the encoder has time to send data back to the drive. Torque based feedforward terms allow you to lower following error with virtually no stability penalty.

12.4.5.1 Shape Based Feedforward Tuning

To adjust IL.KAFF:

- Tune the VL.KP and VL.KI as shown above in the velocity loop tuning section. Set DRV.OPMODE to velocity (or set PL.KP and PL.KI to 0 and vl.kvff to 1).
- Set up a short, repeating service motion with accelerations that are representative of the moves you will use in your application (exact values for acceleration are not critical).
- Turn up IL.KAFF until the position error (PL.ERR) is proportional to the inverted velocity command. The adjustment of IL.KAFF will focus on removing bumps on acceleration and deceleration. The picture below has an ideal value of IL.KAFF of 1.7.

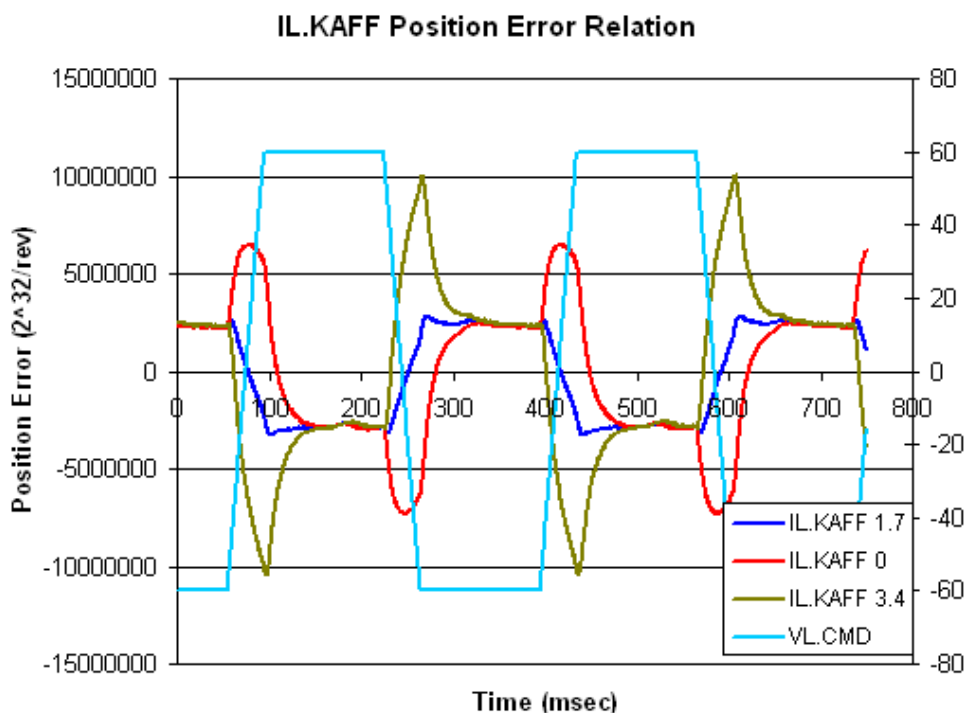

12.4.6 Using Anti-Resonance Filters

The AKD PDMM has four anti-resonance filters. Two filters are in the forward path and two are in the feedback path.

Similarities

- Both types are typically used to enhance stability and performance of the system.

Differences

- Forward path filters result in higher phase lag in closed loop system response.
- Forward path filters limit spectrum from reaching the motor / feedback path filters only filter the feedback after it has been to the motor.

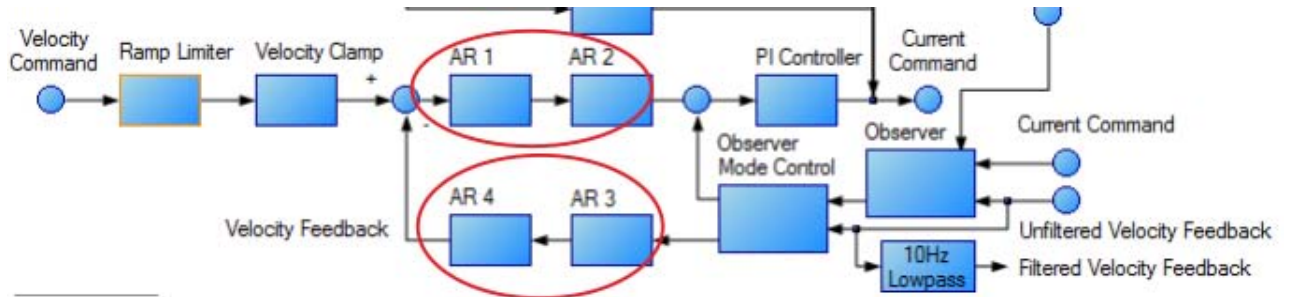

12.4.6.1 Types of Anti-Resonance Filters

Low Pass

A low pass filter allows signals through below a corner frequency and attenuates the signals above the same corner frequency. The behavior at the corner frequency can be specified with the low-pass Q.

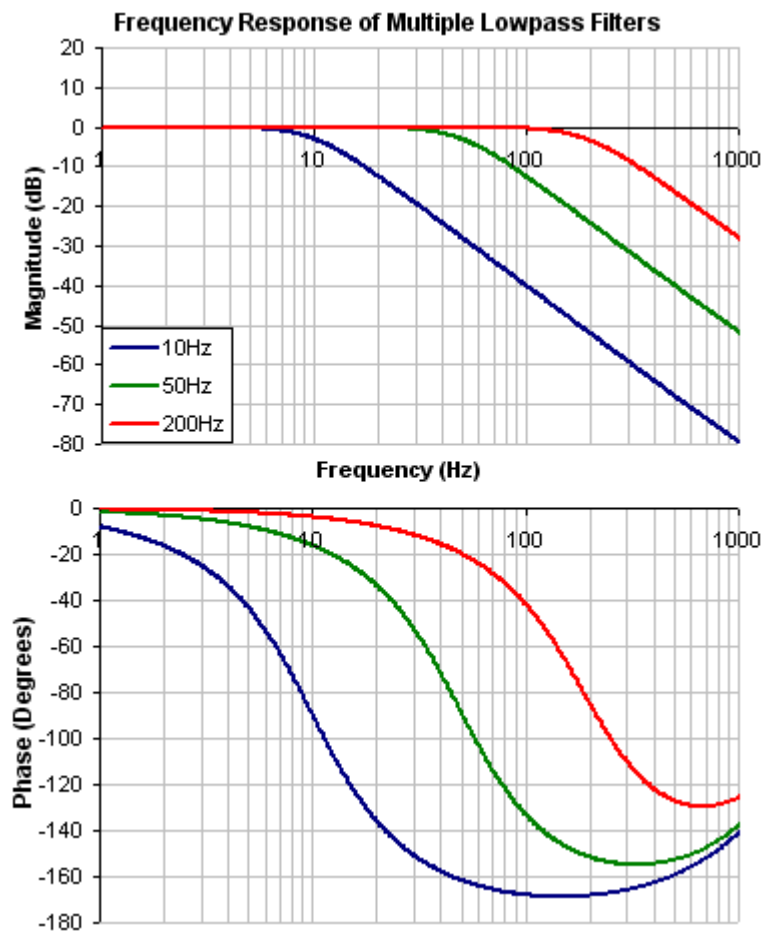

To specify a lowpass filter, you must specify the frequency and Q for both the zero and pole on anti-resonance filter 1. To do this, see the following example using the terminal commands that sets:

- o Filter Type = Biquad
- o Zero frequency = 700 Hz (This is the Lowpass cutoff frequency)
- o Zero Q = 0.707
- o Pole frequency = 5000 Hz
- o Pole Q = 0.707

VL.ARTYPE1 0

VL.ARZF1 700

VL.ARZQ1 0.707

VL.ARP1 5000

VL.ARPQ1 0.707

Lead Lag

A lead lag filter is a filter that has 0 dB gain at low frequencies and a gain that you specify at high frequencies. You also specify the frequency that the gain at which the transition occurs.

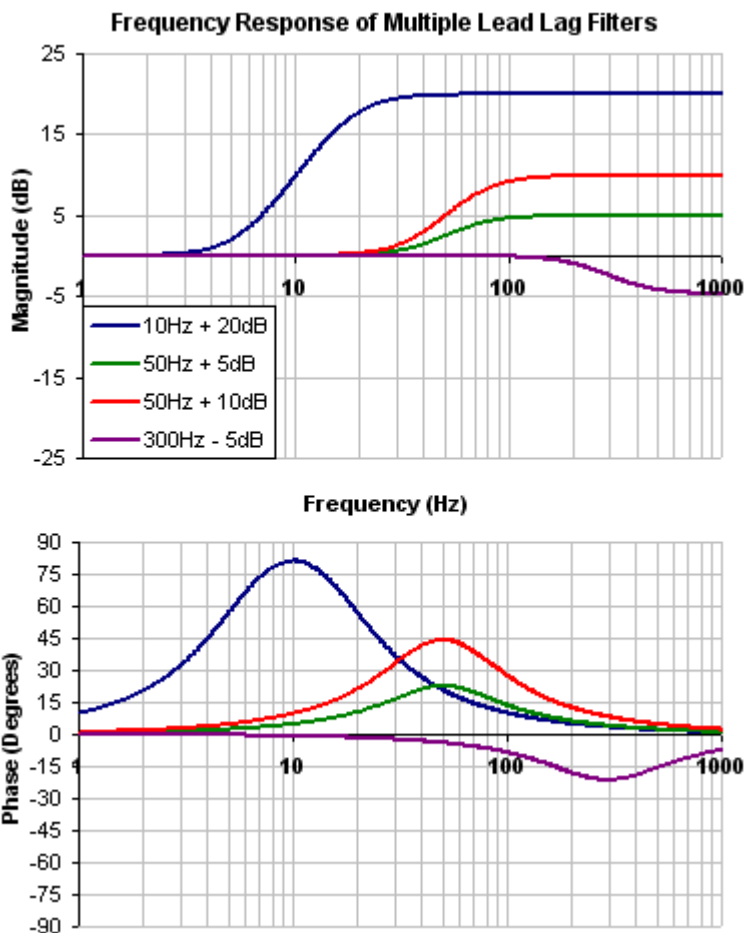

To specify a Lead Lag filter, you must specify the Center Frequency and high frequency Gain (dB). To do this, see the following example by clicking on the Velocity Loop:

Click on Velocity Loop tab (1), then select the AR1 Tab (2), using the Filter Type drop-down, select Lead Lag (3), lastly, enter the desired Center Frequency and Gain of the Lead Lag filter (4).

Velocity Loop
The parameters for controlling the velocity of the motor.

Velocity Profile

Velocity Command

Acceleration Feed Forward

Friction Compensation

Viscous Damping Compensation

Observer Bandwidth

Current Command

Observer

Observer Mode Control

Unfiltered Velocity F

Filtered Velocity Fee

10Hz Lowpass

Ramp Limiter

Velocity Clamp

AR 1

AR 2

PI Controller

Observer

Source

Status

Velocity Feedback

AR 4

AR 3

AR Filter

Select AR Type:

AR 1	Lead Lag
AR 2	Unity Gain
AR 3	Low Pass
AR 4	Unity Gain

Filter Type: 3 - Lead Lag

Edit Parameters

Center Frequency: 500,000

Gain (dB): 0,000

Numerator: Frequency: 500,000 Hz Q: 0,500

Denominator: Frequency: 500,000 Hz Q: 0,500

Notch

A notch filter changes gain at a specific frequency. You specify the frequency at which the gain change occurs (Frequency (Hz)), how wide of a frequency range the cut occurs (Q), and how much the gain changes (Notch Depth (dB)).

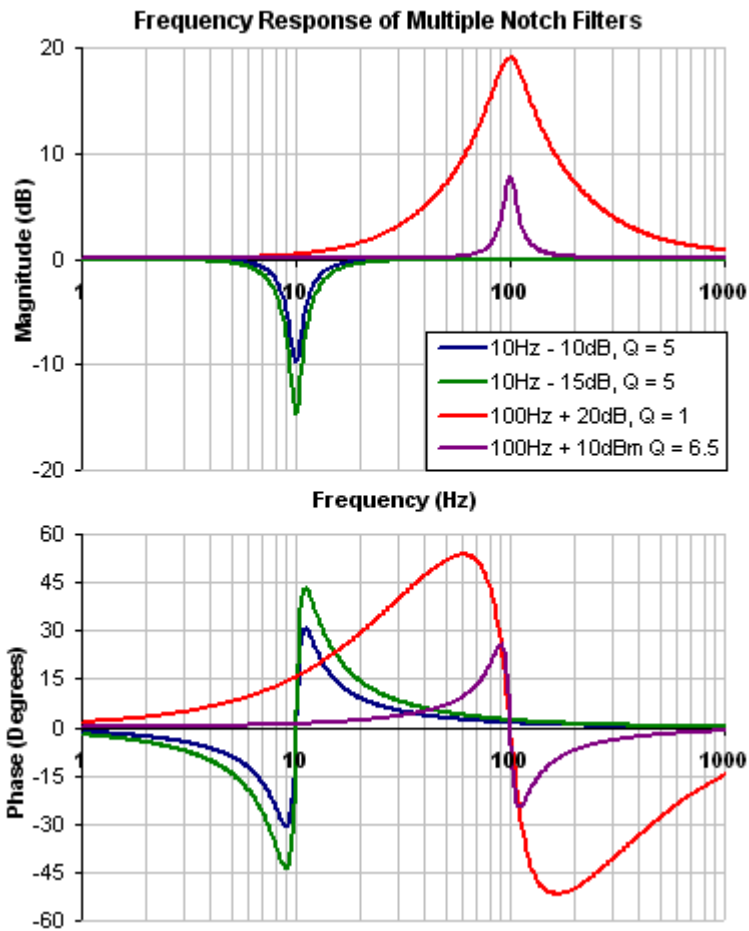

To specify a notch filter, you must specify the Frequency (Hz), Depth (dB) and Width (Q) of the notch. To do this, see the following example by clicking on the Velocity Loop:

Click on Velocity Loop (1), then select the AR1 Tab (2), using the Filter Type drop-down, select Notch (3), lastly, enter the desired Frequency, Depth and Q of the Notch filter (4).

Velocity Loop
The parameters for controlling the velocity of the motor.

The diagram shows the following components and flow:

- Velocity Profile** and **Velocity Command** inputs.
- Ramp Limiter** and **Velocity Clamp** blocks.
- Acceleration Feed Forward** block (d/dt).
- Friction Compensation** block (SIGN).
- Viscous Damping Compensation** block.
- AR 1**, **AR 2**, **AR 3**, and **AR 4** blocks.
- PI Controller** block.
- Observer Mode Control** block.
- Observer** block.
- 10Hz Lowpass** block.
- Current Command** output.
- Velocity Feedback** loop.

AR Filter Configuration:

Select AR Type:	Filter Type:
AR 1 Notch	2 - Notch
AR 2 Unity Gain	
AR 3 Low Pass	
AR 4 Unity Gain	

Edit Parameters for 2 - Notch:

- Frequency (Hz): 500,000
- Depth (dB): 0,000
- Q: 0,600

Observer Parameters:

- Numerator: Frequency: 500,000 Hz
- Denominator: Frequency: 500,000 Hz

Biquad

A biquad is a flexible filter that can be thought up as being made up of two simpler filters; a zero (numerator) and a pole (denominator). In fact, the pre-defined filters mentioned above are really just special cases of the biquad.

Both the zero (numerator) and the pole (denominator) have a flat frequency response at low frequencies and a rising frequency response at high frequencies. The transition frequency and damping must be specified for both the numerator and denominator.

Analyzing the numerator and denominator, the frequency response calculation is simple:

If the numerator and denominator are plotted in dB, the biquad response is numerator – denominator. Understanding how the numerator and denominator work is crucial in understanding how a biquad frequency response is created.

Below is an example of a biquad filter similar to a Lead Lag filter type. To help understand how to determine the frequency response of the biquad, the numerator and denominator response have been plotted. If the denominator is subtracted from the numerator, the biquad response is the result.

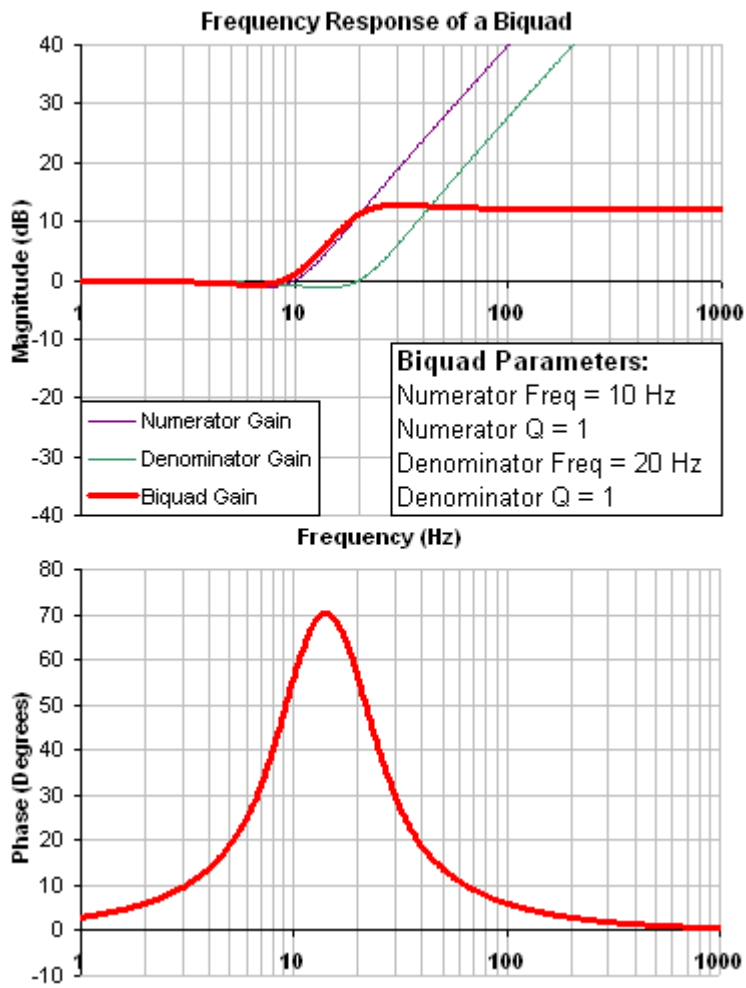

The biquad filter is very flexible, which allows custom filters to be designed. Below is an example of a resonance filter using a biquad. Notice how the high Q values affect the numerator and denominator. This gives a biquad frequency response similar to a mechanical resonance.

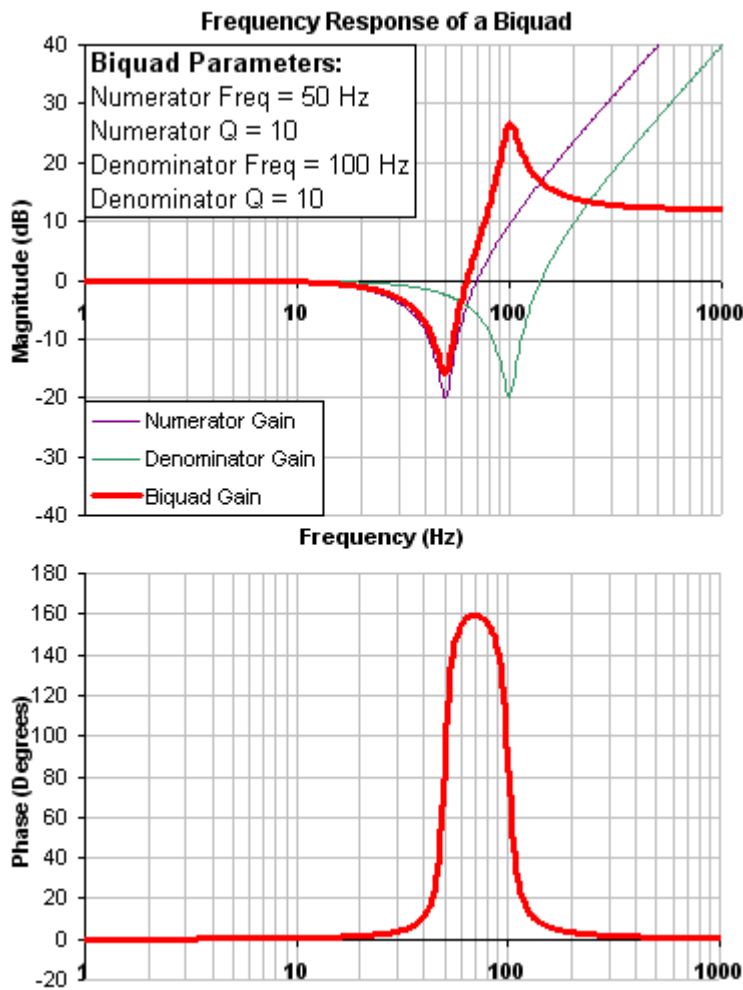

The previous two examples used a numerator frequency lower than the denominator frequency, yielding a positive gain in high frequencies. If the denominator frequency is lower than the numerator frequency, then high frequencies will have a negative gain.

Below is an example where the numerator frequency is higher than the denominator. Notice the high frequencies have a negative gain.

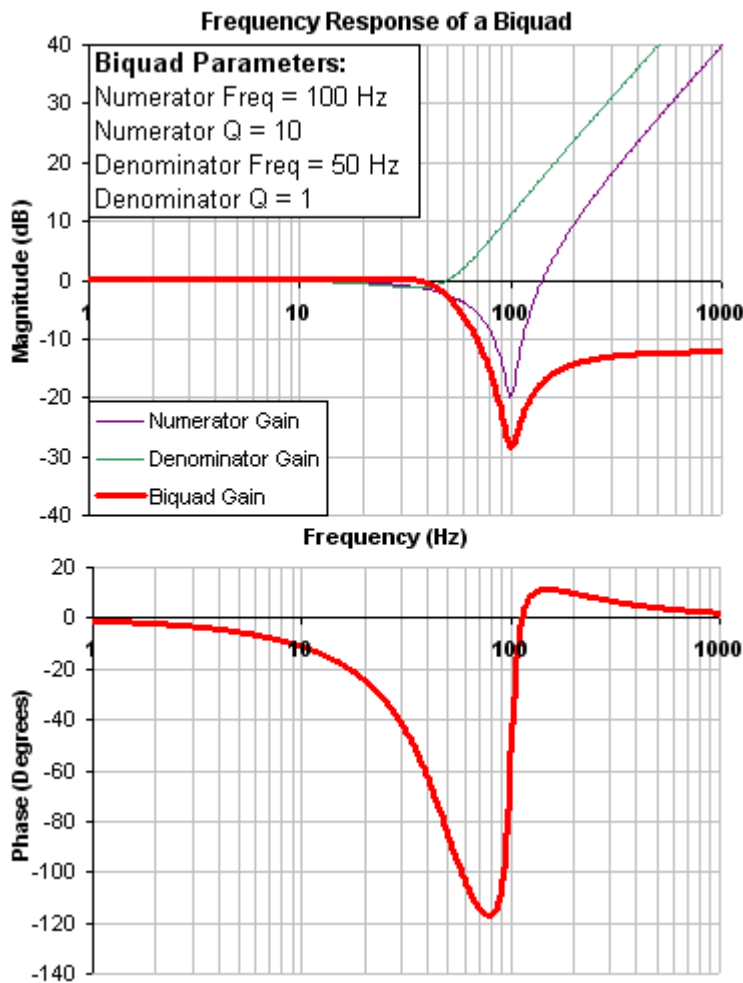

To specify a biquad filter, you must specify the frequency and Q for both the zero and the pole on anti-resonance filter 3. To do this, see the following example using the terminal commands that sets:

- o Filter Type = Biquad
- o Zero frequency = 100 Hz
- o Zero Q = 0.7
- o Pole frequency = 1000 Hz
- o Pole Q = 0.8

```
VL.ARTYPE3 0
VL.ARZF3 100
VL.ARZQ3 0.7
VL.ARPF3 1000
VL.ARPQ3 0.8
```

12.4.6.2 Biquad Calculations

In the s-domain, the linear biquad response is calculated:

$$\text{Biquad Frequency Response} = \frac{s^2 + \frac{\omega_N}{Q_N} s + \omega_N^2}{s^2 + \frac{\omega_D}{Q_D} s + \omega_D^2}$$

To convert from idealized s-domain behavior to a more realistic z-domain behavior, we convert using a pole / zero transform. To calculate the frequency response for an individual frequency:

$$t = 62.5 \mu \text{ sec}$$

$$N_{Rad} = 1 - (2Q_N)^{-2}$$

$$N_{2Unscaled} = 1$$

$$\text{if}(N_{Rad} > 0): N_{1Unscaled} = -2e^{-2\omega_N \zeta_N t} \cos(\omega_N t \sqrt{1 - \zeta^2})$$

$$\text{if}(N_{Rad} \leq 0): N_{1Unscaled} = -2e^{-2\omega_N \zeta_N t} \cosh(\omega_N t \sqrt{1 - \zeta^2})$$

$$N_{0Unscaled} = e^{-2\omega_N \zeta_N t}$$

$$D_{Rad} = 1 - (2Q_D)^{-2}$$

$$D_2 = 1$$

$$\text{if}(D_{Rad} > 0): D_1 = -2e^{-2\omega_D \zeta_D t} \cos(\omega_D t \sqrt{1 - \zeta^2})$$

$$\text{if}(D_{Rad} \leq 0): D_1 = -2e^{-2\omega_D \zeta_D t} \cosh(\omega_D t \sqrt{1 - \zeta^2})$$

$$D_0 = e^{-2\omega_D \zeta_D t}$$

$$N_{Scale} = \frac{N_{0Unscaled} + N_{1Unscaled} + N_{2Unscaled}}{D_0 + D_1 + D_2}$$

$$N_2 = N_{2Unscaled} / N_{Scale}$$

$$N_1 = N_{1Unscaled} / N_{Scale}$$

$$N_0 = N_{0Unscaled} / N_{Scale}$$

$$\angle_z = \omega t = 2\pi * freq * t$$

$$Num_{Re} = N_2 \cos(2\angle_z) + N_1 \cos(\angle_z) + N_0$$

$$Num_{Im} = N_2 \sin(2\angle_z) + N_1 \sin(\angle_z)$$

$$Den_{Re} = D_2 \cos(2\angle_z) + D_1 \cos(\angle_z) + D_0$$

$$Den_{Im} = D_2 \sin(2\angle_z) + D_1 \sin(\angle_z)$$

$$Gain_{dB} = 20 \log_{10} \left(\frac{\sqrt{Num_{Re}^2 + Num_{Im}^2}}{\sqrt{Den_{Re}^2 + Den_{Im}^2}} \right)$$

$$Phase_{deg} = \frac{180}{\pi} \left(\tan^{-1} \left(\frac{Num_{Re}}{Num_{Im}} \right) - \tan^{-1} \left(\frac{Den_{Re}}{Den_{Im}} \right) \right)$$

12.4.6.3 Common Uses Of Anti-Resonance Filters

Low pass filters in the feedback path. This is a common way to deal with noisy feedback sensors. When used in combination with noisy feedback sensors, significant reduction in audible noise can result.

Lead / lag filters in the forward path. This is a common way to achieve phase lead for control loops without exciting high frequency resonances.

Low pass filters in the forward path. This is a common way to limit high frequency energy from reaching a system that can not productively use energy at these high frequencies. This is also used to lower the effect of system resonances over a wide range of frequencies.

Notch filters are used to cancel system resonances. Notch filters are designed to be the opposite in amplitude of system resonances. Notch filters are applied to very specific frequencies, and therefore you must know your system resonance frequencies accurately to use them effectively.

13 Scope

13.1 Overview

The scope allows you to plot up to six different parameters from the drive. Use **Full View** and **Normal View** to toggle between the scope setup (normal) and a larger view of only the scope output (full). You can configure, save, and restore scope settings from the normal view. The lower right corner of the normal view also includes a box that indicates status and drive and scope control buttons (**Enable Drive**, **Start Recording**, and **Refresh**).

13.2 Using the Scope

You can set up scope plots using the tabs summarized below:

Tab	Function
Channels	Select data source, plot axes, and plot appearance.
Time Base and Trigger	Select how much data to record and when to start recording the data.
Servo Gains	Adjust the servo loop gains.
All Gains	View all current tuning gains in the drive and manually edit gains.
AR1, AR2, AR3, AR4	Adjust filter settings.
Save and Print	Save the plot as a raw data file or as an image file; email the plot; print the plot; open the data file in Excel.
Measure	Display basic data read from the plots.
Cursors	Turn on the cursors and view the data at the cursor positions.
Display	Pan, zoom, and control the grid and background color.

13.2.1 Scope Channels Tab

The **Channels** tab allows you to select and record up to six channels simultaneously. Select the data to record for each channel from the lists in the **Source**, **Color**, **Y-axis**, and **Filter** and **Filter Frequency** columns. Once a recording is shown on the scope screen, you can click **Hide** to remove a channel from the scope display.

Channels						
Time-base and Trigger						
Service Motion						
Servo Gains						
Observer						
All Gains						
Id	Source	Color	Hide	Y Axis	Filter	Filter Frequency
1	Current feedback (IL.FB)	Red	<input type="checkbox"/>	Current	<input type="checkbox"/>	400
2	Velocity command (VL.CM...	Green	<input type="checkbox"/>	Velocity	<input type="checkbox"/>	400
3	Velocity feedback (VL.FB)	Blue	<input type="checkbox"/>	Velocity	<input type="checkbox"/>	400
4	None	Purple	<input type="checkbox"/>	Default	<input type="checkbox"/>	400
5	None	Purple	<input type="checkbox"/>	Default	<input type="checkbox"/>	400
6	None	Orange	<input type="checkbox"/>	Default	<input type="checkbox"/>	400

13.2.1.1 Source Column

To set a channel to record, click the source you want to set and choose the appropriate channel. You can choose from None (no data is collected on that channel), preset trace types, or enter a user defined trace. Choosing "<User Defined>" allows you to record data from pre-defined locations. These locations are provided by the factory to collect less common values.

Channels						
Time-base and Trigger						
Service Motion						
Servo Gains						
Observer						
All Gains						
Id	Source	Color	Hide	Y Axis	Filter	Filter Frequency
1	Analog input signal (AIN.V)	Red	<input type="checkbox"/>	Analog I/O	<input type="checkbox"/>	400
2	Analog input signal (AIN.V)	Green	<input type="checkbox"/>	Velocity	<input type="checkbox"/>	400
3	Analog output user value (AOUT)	Blue	<input type="checkbox"/>	Velocity	<input type="checkbox"/>	400
4	Analog output value (AOUT)	Purple	<input type="checkbox"/>	Default	<input type="checkbox"/>	400
5	Bus voltage (VBUS.VALUE)	Pink	<input type="checkbox"/>	Default	<input type="checkbox"/>	400
6	Current - U winding of motor	Purple	<input type="checkbox"/>	Default	<input type="checkbox"/>	400
6	Current - V winding of motor	Orange	<input type="checkbox"/>	Default	<input type="checkbox"/>	400
6	Current command (IL.CMD)	Orange	<input type="checkbox"/>	Default	<input type="checkbox"/>	400

13.2.1.2 Color Column

For valid sources, you can click on the color in the Color tab and choose a different color than the default, or create a custom color.

13.2.1.3 Hide Column

You can check the **Hide** box to hide a given plot trace. This feature can make it easier to focus on specific data as needed.

13.2.1.4 Y-Axis Column

The Y-axis column allows you to choose on which Y-axis the channel will be displayed. Several predefined Y-axis groups exist. Click on the item in the column to change the label for the trace.

13.2.1.5 Filter and Filter Frequency Column

Check this box and use the frequency column to apply a low pass filter to the data collected. The filter is applied when the data is collected. It is not applied to data already collected if this is checked after the data is collected.

13.2.2 Measure Tab

The measure tab displays basic data reads from the plots.

13.2.2.1 AC RMS and True RMS

In the measure tab, there is a column for AC RMS and a column for True RMS. True or full RMS is the full heating value of a signal and includes any DC terms in the value. AC RMS removes any DC value and gives only the RMS value as a measure of a signal's standard deviation.

$$\text{True RMS} = \sqrt{\text{Sum}(x[n]^2)/N} \text{ where } N \text{ is number of points}$$

$$\text{AC RMS} = \sqrt{(\text{True RMS})^2 - (\text{dc or average value})^2}$$

13.2.3 Scope Time-base and Trigger Tab

Use the **Time-base and Trigger** tab to select how much data to record and when to start (trigger) recording the data. You can set length of recording in ms and the sampling frequency in Hz. The number of samples is a calculated value displayed for reference. The trigger can be set to trigger immediately when you click **Start Recording** or to trigger when a specified value for a given signal is reached. The default **Time-base and Trigger** view specifies recording time, sampling frequency, and either an immediate trigger or a trigger based on a specified signal. Click the **More** button in this view

to specify a given number of samples, sampling frequency, sampling interval, and access additional trigger options.

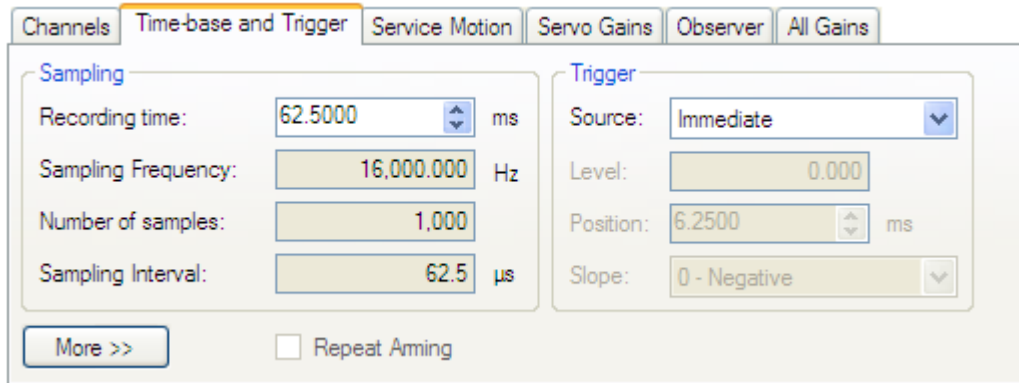

In this tab, you can set length of recording in ms and the sampling frequency in Hz. The number of samples is a calculated value displayed for reference. You can also choose the trigger source to be **Immediate** (triggers as soon as you click the **Start Recording** button) or to be one of many predefined sources.

If you choose a source other than **Immediate**, you can set the level, position, and slope for the trigger value.

- Level sets the value of the source that triggers the recording to start.
- Position sets the amount of time that the scope displays before the trigger occurred.
- Slope sets whether the source data must pass the level value in a positive or negative direction.

An example of triggering is shown below:

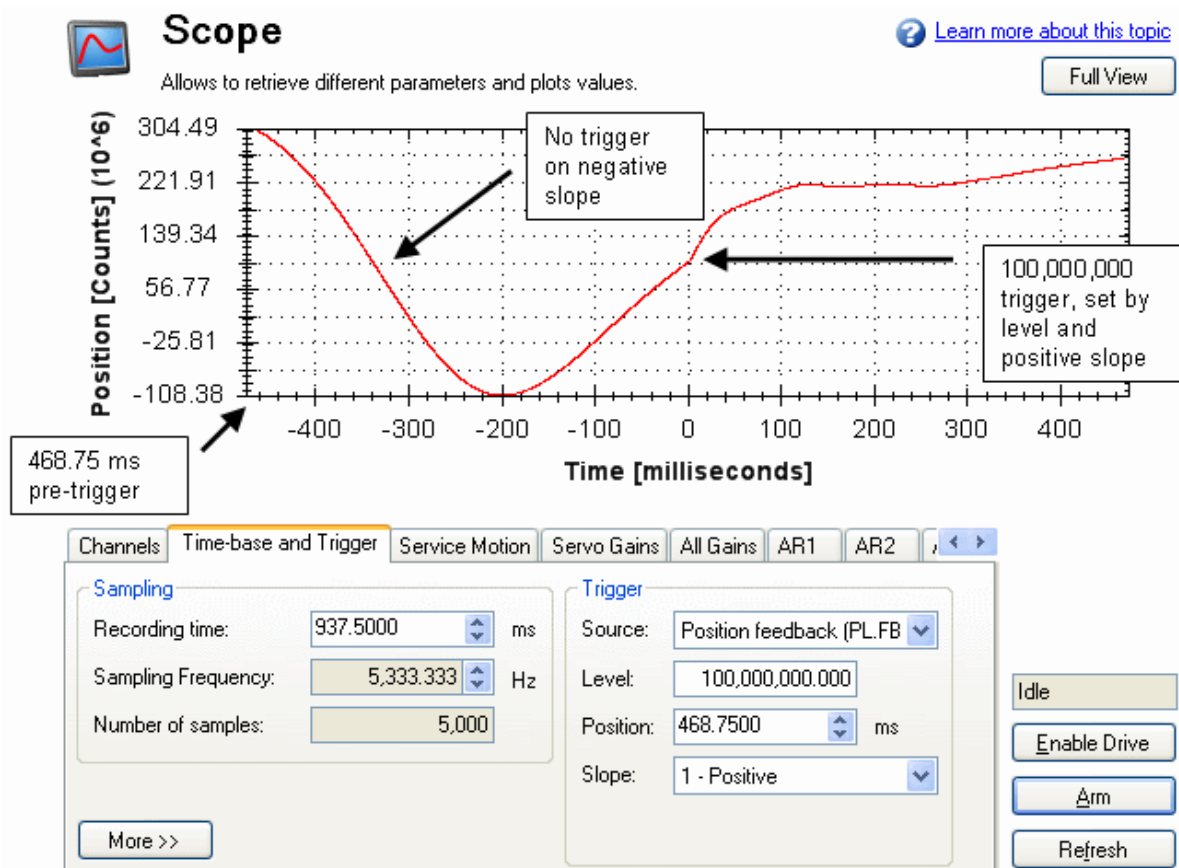

13.2.3.1 Scope Time-base and Trigger, More View

Click **More** to display additional options for configuring the time-base and trigger.

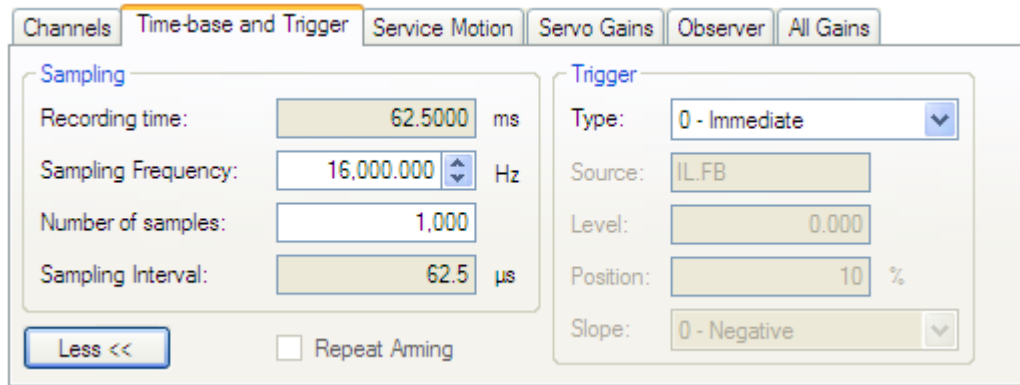

In the **Sampling** area of this view, you can specify the recording length by entering a sampling frequency and a number of samples. Here, the recording time is a calculated value displayed for reference.

What is triggering?

Triggering allows you to precisely control the start point of data collected in the scope. For example, if you are looking for a large spike, you can set the trigger to start the scope to begin recording when it sees the large spike. This section describes the triggering functionality of the scope.

Test Signal

As an example, it is useful to examine variations on a record of a test signal that generates a sawtooth signal. The signal starts at 0 and increases by one every drive sample (1/16,000 second) to a maximum of 9, and then returns to 0. This signal continues indefinitely. The record of this signal is shown below.

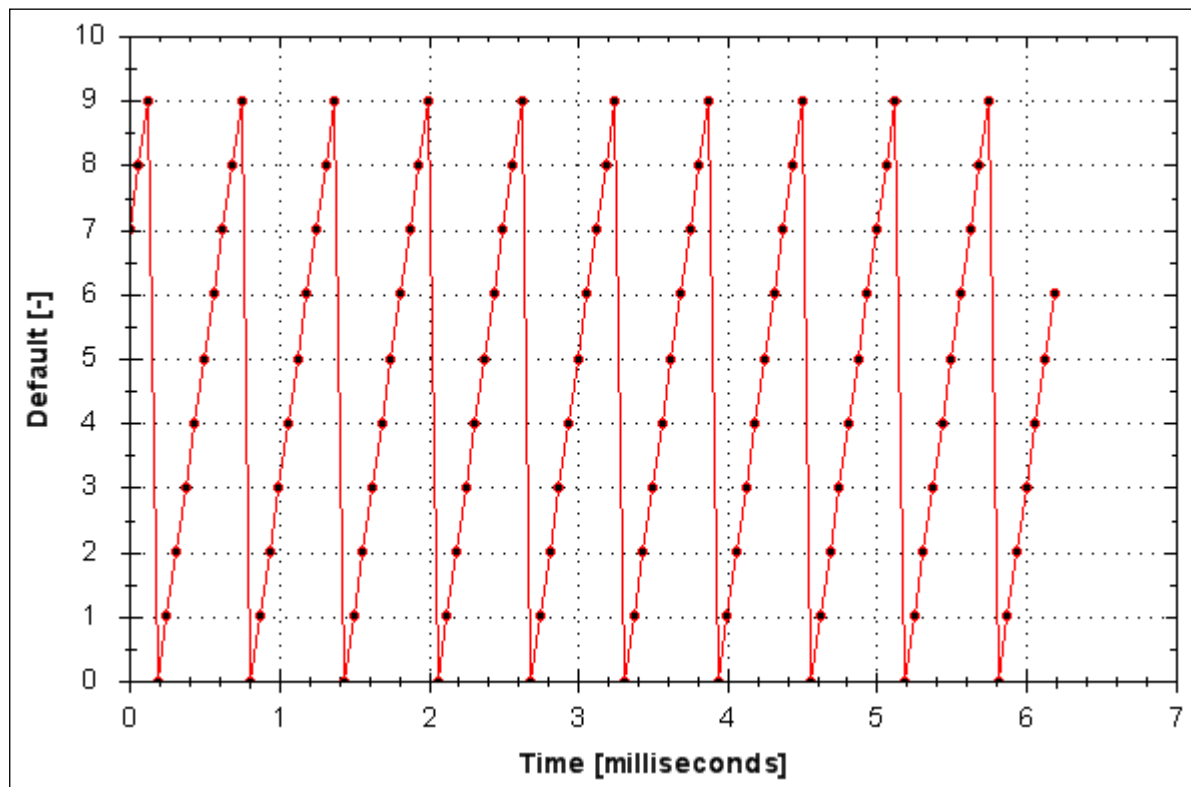

13.2.3.2 Trigger Type

The **Trigger** area in the **More** view offers more flexibility than the default view. You can specify four types of trigger types (REC.TRIGTYPE):

- **Immediate - 0.** This mode will start recording as soon as the recording command (REC.TRIG) is received by the drive.
- **Command / On Next Command – 1.** This trigger type lets you specify a trigger on the next telnet command received by the drive. This is useful in a telnet session via Hyperterminal (or a similar program). EWV¹ is constantly sending telnet commands, so this is not typically used in a EWV session.
- **Parameter / On Source Signal – 2.** This trigger type lets you specify a trigger source and set of conditions to trigger recording of data. This is very similar to the triggering used on oscilloscopes.
- **Boolean – 3.** This trigger type lets you trigger on a boolean (0 or 1), such as drive active status.

13.2.3.3 Trigger Position

Trigger Position (REC.TRIGPOS) allows you to collect data that occurs before the trigger occurs. If you have a rare condition, you may want to see the conditions that led up to it. Trigger position lets you control how much signal is collected before the trigger condition occurred.

Trigger position is specified in units of percent (%). If you specify a trigger position of X% , X% of the data is before 0 ms in the data time and 100-X% (the rest of the data) is at or greater than 0 ms. In the picture below, trigger position is set to 25% (REC.TRIGPOS 25).

In the EWV scope, the 0 time point is clear. When collecting the data via REC.RETRIEVE or similar commands, the time is not returned, so some caution should be used when the trigger point is important to understand.

Trigger position is not used in trigger type “Immediate” (TRIGTYPE 0).

¹Embedded Workbench Views

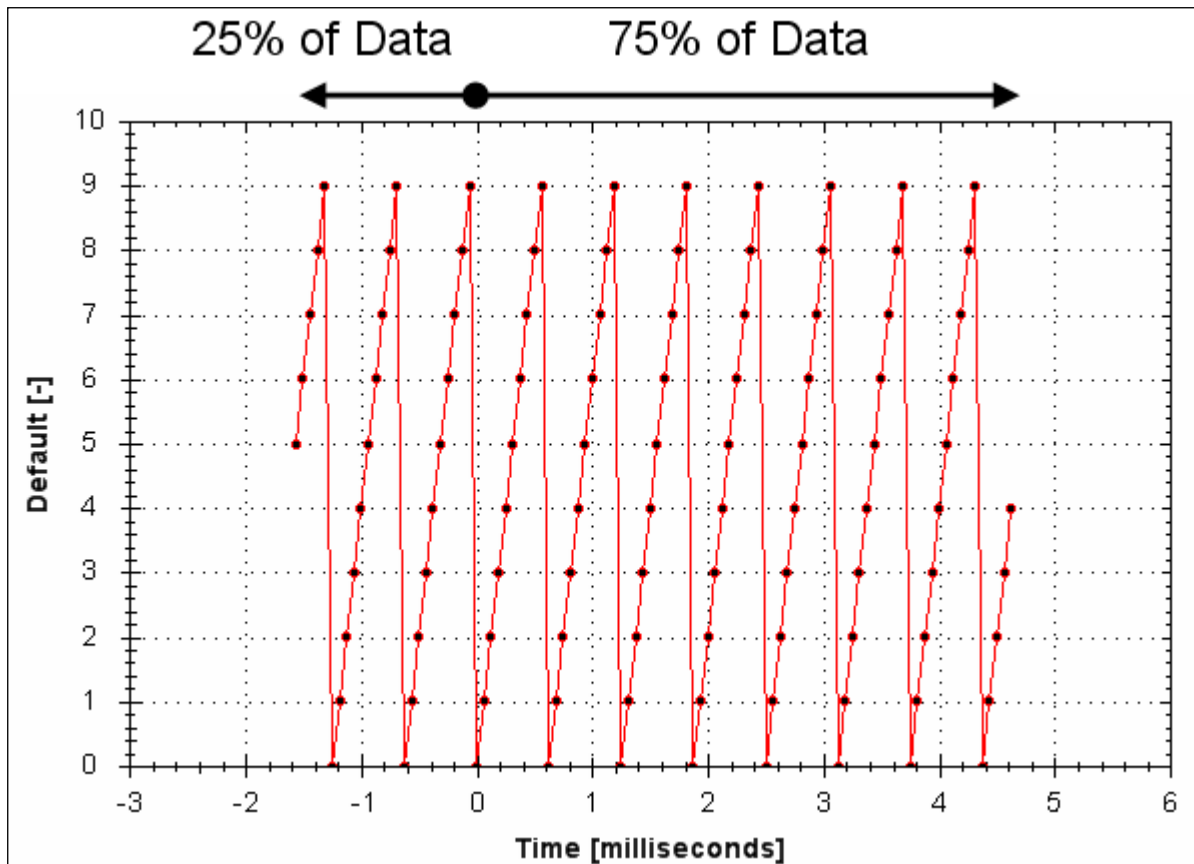

13.2.3.4 Trigger Value

The trigger value (REC.TRIGVAL) specifies a target value that should trigger the recording to start. The trigger value is used in trigger type Parameter / On Next Signal only.

The trigger value is not used in the boolean trigger type. Use the trigger slope to set the polarity of the boolean trigger.

When the trigger slope is positive, the trigger value will trigger when:

- The trigger source is less than the trigger value in the previous recording sample
- The trigger source is greater than or equal to the trigger value in the current recording sample

Below is an example showing triggering of trigger value of 3 (REC.TRIGVAL 3) and positive trigger slope (REC.TRIGSLOPE 1). You can see that the recording triggers at time zero when the source reaches the value of 3.

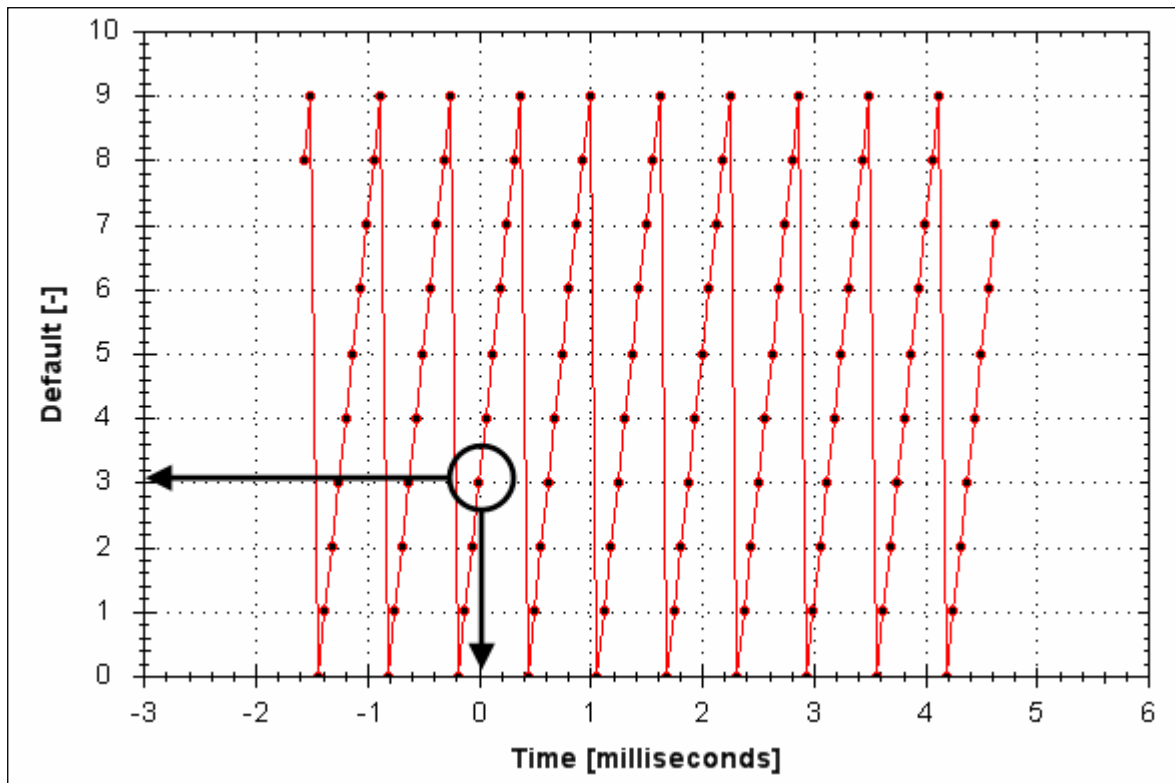

When the trigger slope is negative, the trigger value will trigger when:

- The trigger source is greater than the trigger value in the previous recording sample.
- The trigger source is less than or equal to the trigger value in the current recording sample.

13.2.3.5 Effects of Recorder Gap

When the recording rate is less than 16,000 Hz ($REC.GAP > 1$), there can be some impact on the triggering of the recorder. When using pretriggering and a recording rate of less than 16,000 Hz, the trigger only evaluates every N samples, where N is the value of REC.GAP. Two effects result from this condition:

1. You cannot be sure of the moment that the recorder is triggered any closer than N samples. An example of this is shown below where the trigger value is set to 3, the trigger slope is positive and the recorder gap is 2. Both examples are the same data, but one instance collected and triggered on the odd data. The other example collected and triggered on the even data.

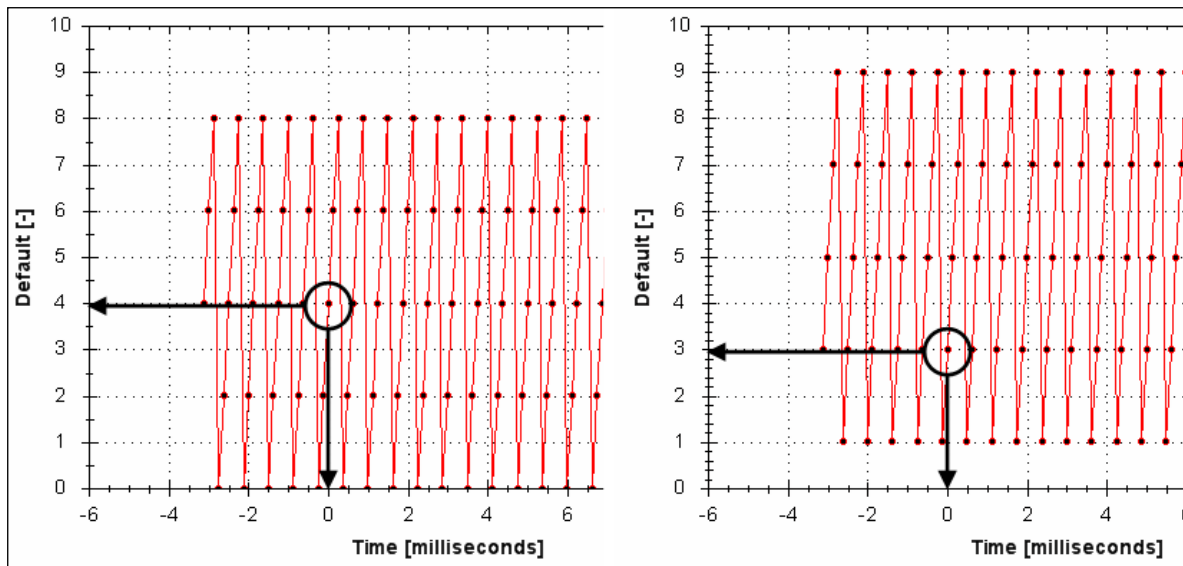

2. You can miss triggers, whose duration is less than N samples, where N is the value of REC.GAP. This is because the trigger is only evaluated every N samples.

A workaround for the above effects is available by setting the recorder trigger position to zero (REC.TRIGPOS 0). This eliminates conflicts between pretrigger and post-trigger timing and will guarantee trigger evaluation every sample, eliminating the cases above.

13.2.3.6 Trigger Slope

Trigger Slope specifies whether you trigger on a positive or negative change in the trigger source. The effect of the trigger slope is different for trigger type Boolean and On Next Signal modes.

Boolean Trigger Type

When using Boolean type:

- A positive slope will trigger when the trigger source is 1
- A negative slope will trigger when the trigger source is 0

The boolean trigger type is a state trigger. There is no need to transition from 0 to 1 to trigger with the positive slope. If the trigger source is 1 from the start, the positive slope will immediately trigger.

On Next Signal Trigger Type

The “On Next Signal” trigger type allows you to specify if the recorder should trigger when the signal crosses the trigger level in the positive or negative direction. The signal only needs to reach the trigger level; it does not need to pass the trigger level.

In the examples below, the trigger value is set to 3 (REC.TRIGVAL 3.000). You can see that with positive slope, the trigger occurs exactly when the signal transitions from 2 to 3, because it reached 3. The negative slope case triggers when the signal transitions from 9 to 0, because it crossed 3 on the way.

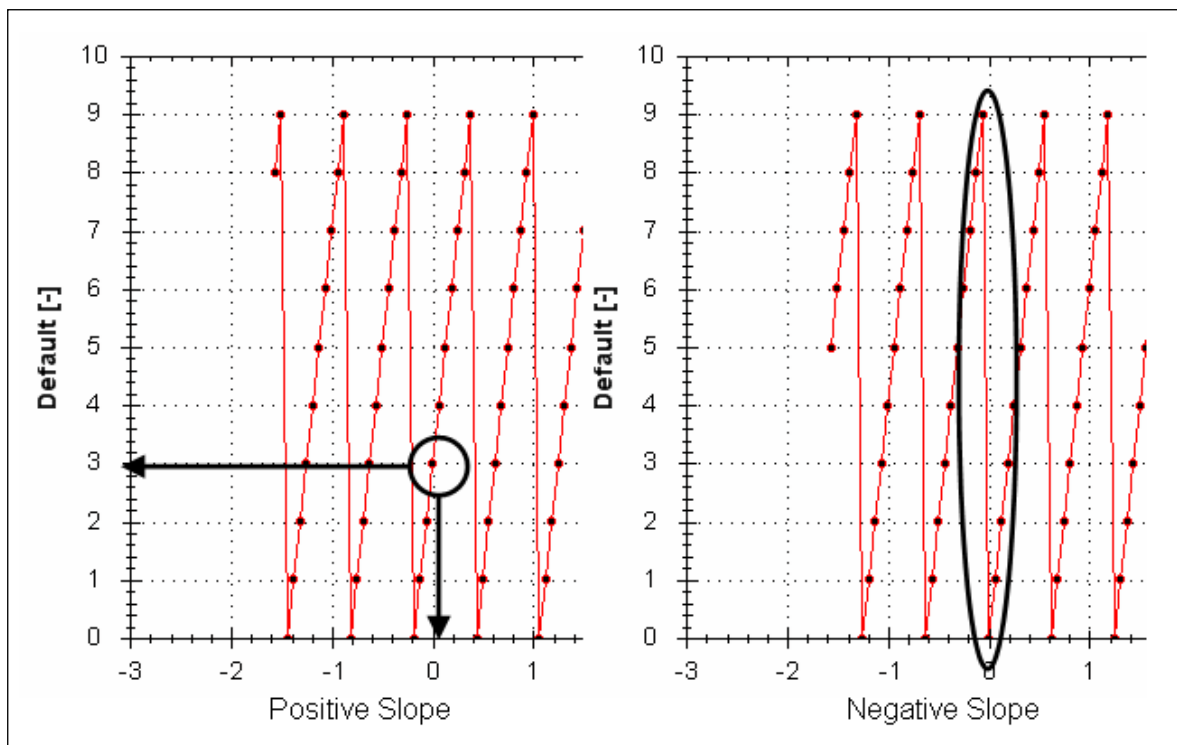

13.3 Scope Settings

Scope settings are used to store and retrieve the scope parameters. You can save multiple settings, called "presets", under different names. You can save, delete, import, or export the presets. The settings are stored in EWW project file (default.wbproj) and settings are common to all the drives in EWW.

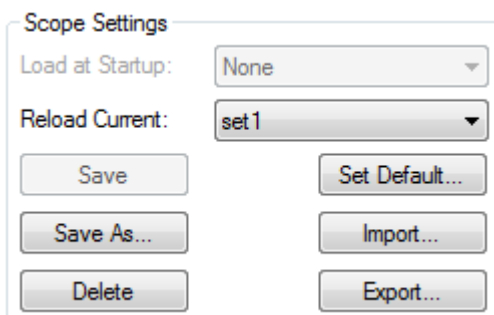

NOTE
 The Load at Startup option is enabled/disabled from the Tools > User Options menu in KAS.

13.3.1 Load a setting (preset) to Scope screen

In Scope Settings section, the existing presets are listed in the **Select Setting** box. To load a setting to the scope screen, select the desired preset from the **Select Setting** list.

13.3.2 Create a new preset

1. Modify any scope parameters.
2. Select the **Settings** tab.

3. Click **Save As**. The following dialog is displayed:

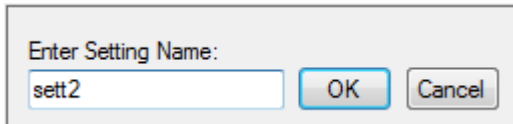

4. Enter the setting name and click **OK**. The current settings are saved as a preset with the given name and displayed in the list.

13.3.3 Save or delete preset

Save saves any modification to the open preset. **Delete** deletes the open preset.

13.3.4 Import preset

Import the presets contained in the selected settings file as follows:

1. Click on Import button and the following dialog will be displayed.

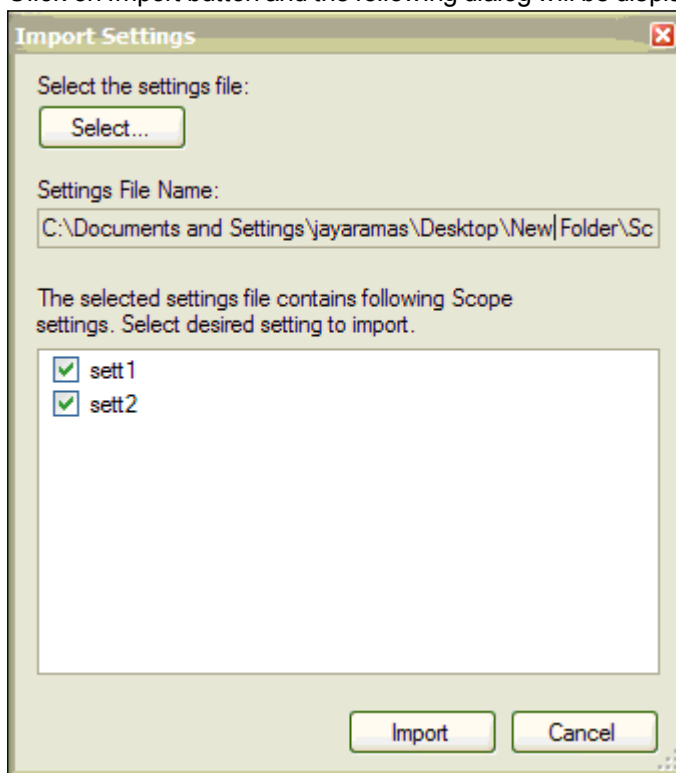

2. Select the settings file by clicking "Select..." button.
3. All the scope presets will be displayed contained in the selected settings file.
4. Select/Deselect the presets and then click on Import.
5. If preset name already exists in application the confirmation message will be shown to user to replace it or to ignore.

13.3.5 Export preset

Export a preset to a file as follows:

1. Click **Export** and the following dialog is displayed:

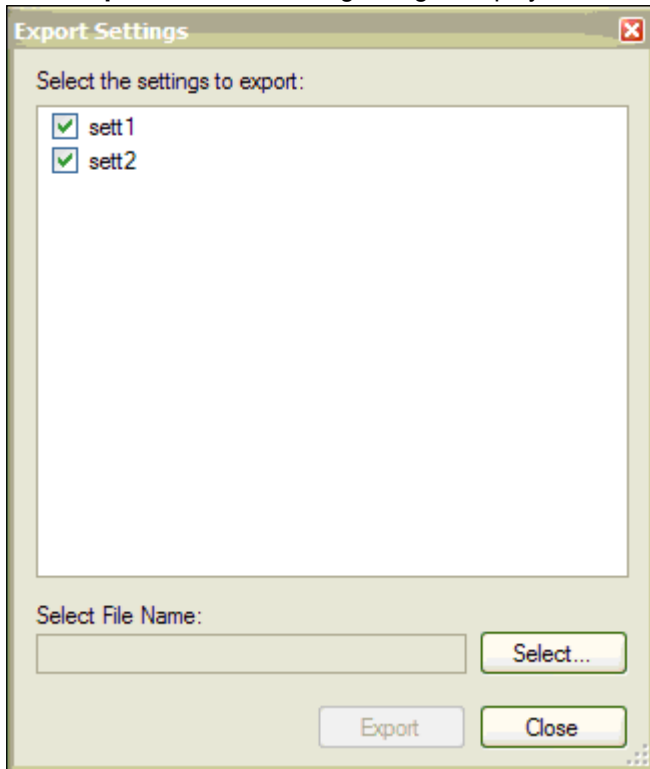

2. The existing presets are displayed and user can select/deselect the preset to export.
3. Select the file name to export.
4. Click **Export** to export the selected presets to a file.

13.3.6 Scope axis scaling and zooming

The scope provides two mechanisms for determining how you view the data:

- Scaling: you can choose the scale for the different axes.
- Zooming: you can choose a particular portion of the scope that you want to observe more in details, and then come back to previous scaling.

Two different scaling modes are provided on each axis:

- Manual: you can determine the minimum and maximum value of the axis (X or Y axis).
- Scale to fit: the program will compute a scale for this axis that will display all the curves bound to it (X or Y axis).

These functionalities are accessible through the contextual menu when right-clicking in the axis zone. A simple left-click in the axis zone will provide the manual range functionality. A supplementary functionality allows you to perform a scale to fit on all axes is also available, which allows a good overview.

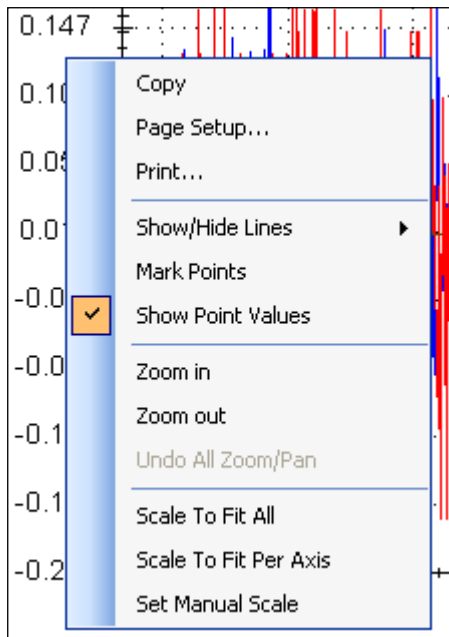

The zoom functionality allows you to navigate in a portion of the graphic. When you reset the zoom, the initial scales are shown.

In the display tab, when “Remember Axis Scale” is set, the scales of the axes are kept between two sequential recordings. You can fine tune the scale to visualize a particular behavior and record a second time and see the same behaviour without having to redo all the tuning. When not checked, a scale to fit all will be performed after each record. This setting is reset when exiting EWV and should be explicitly set at next startup.

13.3.7 Manual range per axis

After recording data, right click anywhere on the y-axis and select **Set Manual Scale** to open a dialog box to set the range for the axis. Enter the Y-axis minimum value and Y-axis maximum value. Click **OK** to reset the Y-axis to new range.

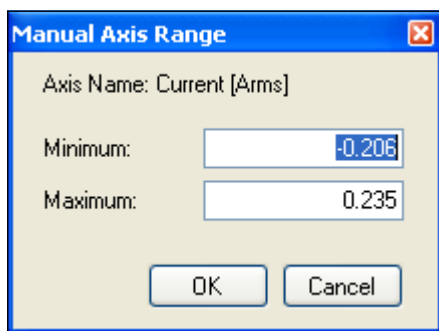

13.3.8 Unit display on Y axis

The unit on the Y-axis is displayed if all scope signals units are identical for that Y-axis. If different units apply to different signals, the units are displayed as [-]. For example, if the velocity Y-axis has signals VL.FB and IL.CMD, then the unit displayed is [-], since the units for these parameters are different. If IL.CMD is hidden, then the correct unit for VL.FB, rpm, is displayed.

Related Parameters:

BODE Parameters (→ p. 278)

14 Using Parameters and the Terminal Screen

14.1 Terminal	166
14.2 Parameter List	170
14.3 Parameter Load/Save	172

14.1 Terminal

14.1.1 Overview

The terminal mode provides a quick and easy way to issue commands to the drive directly. Typically used by "power users" who are familiar with the command set, the terminal mode can help in setup, troubleshooting, and other diagnostic actions. When using the terminal mode, [EWV¹](#) shows the parameter and command set in a popup view and uses an autocomplete tool to help you select the proper parameter or command. Right-click in the command entry area to open a popup menu for editing commands and for clearing the screen. The terminal also provides a macro editor that allows a series of commands to be executed via a single command (called a macro). Macros are useful when you must frequently execute a sequence of commands.

14.1.2 Using the Terminal

Click Terminal in the navigation tree to issue parameters and commands in the terminal mode. You can enter parameters and commands at the prompt as shown in this example:

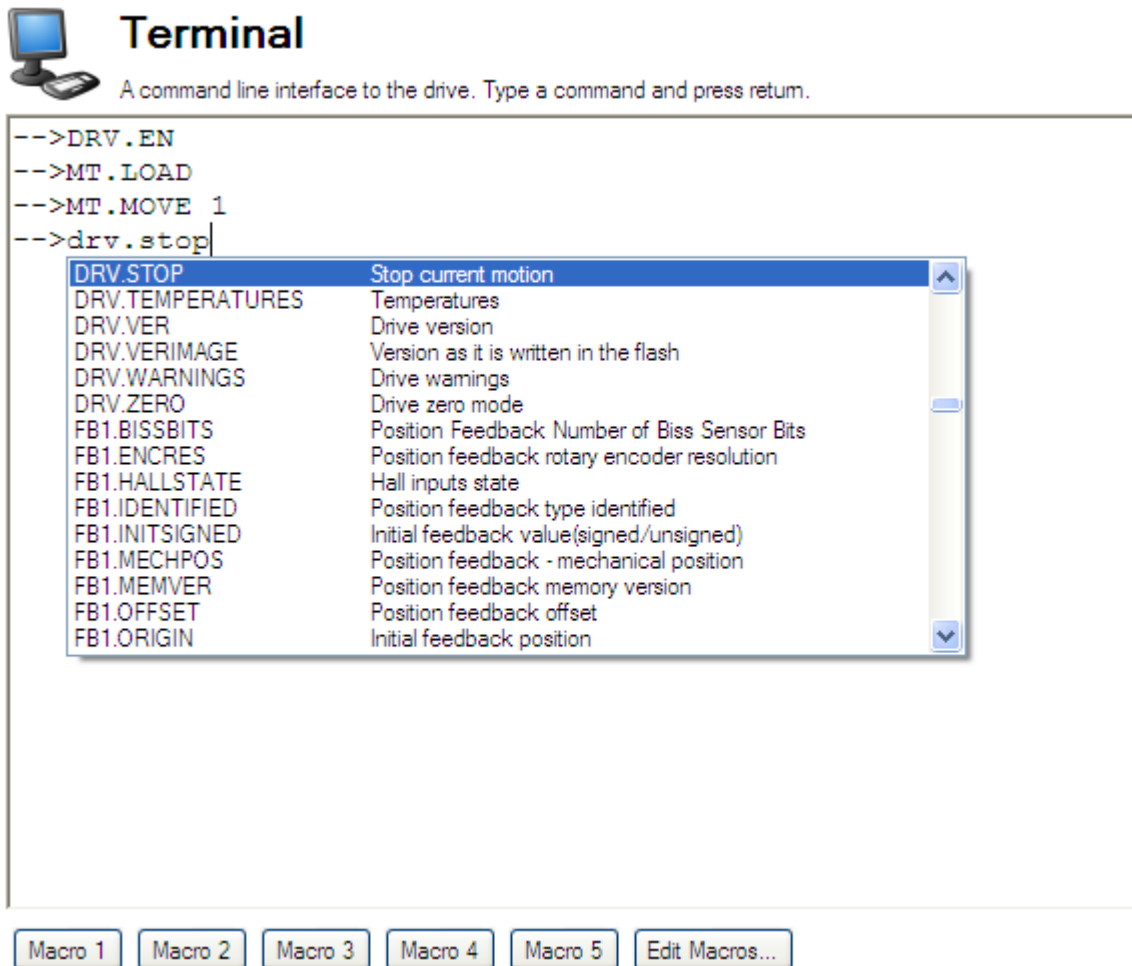

Terminal
A command line interface to the drive. Type a command and press return.

```
-->DRV.EN
-->MT.LOAD
-->MT.MOVE 1
-->drv.stop|
```

DRV.STOP	Stop current motion
DRV.TEMPERATURES	Temperatures
DRV.VER	Drive version
DRV.VERIMAGE	Version as it is written in the flash
DRV.WARNINGS	Drive warnings
DRV.ZERO	Drive zero mode
FB1.BISSBITS	Position Feedback Number of Biss Sensor Bits
FB1.ENCRES	Position feedback rotary encoder resolution
FB1.HALLSTATE	Hall inputs state
FB1.IDENTIFIED	Position feedback type identified
FB1.INITSIGNED	Initial feedback value(signed/unsigned)
FB1.MECHPOS	Position feedback - mechanical position
FB1.MEMVER	Position feedback memory version
FB1.OFFSET	Position feedback offset
FB1.ORIGIN	Initial feedback position

Macro 1 Macro 2 Macro 3 Macro 4 Macro 5 Edit Macros...

The terminal supports the following keyboard shortcuts:

Keyboard Shortcut	Description
F2	Executes the last command.

¹Embedded Workbench Views

Keyboard Shortcut	Description
Up Arrow	Gets the previous command from the command history.
Down Arrow	Gets the next command from the command history.
CTRL+J	Shows the list of commands that the drive supports.
ESC	Hides the command list if command list is open. Clears the line if command list is not open.
Enter (Return)	Executes the current command. This command sends the text you have typed to the drive and then prints the text the drive returns on the next line.

14.1.3 Macros

Macros are a short sequence of instructions that can be sent to the drive using a single button. You can create up to five macros within the terminal mode using the macro editor. Each of the macros can be given a name and will appear as a button below the Terminal screen area. When you select the button, the command set tied to that macro will appear in the Terminal area and the commands will be executed. If there are commands which are not entered correctly, the terminal screen area will indicate the errors.

You can access macros and the macro editor from the buttons are located at the bottom of the terminal screen. Click a macro button to execute the associated macro. The **Edit Macros** button opens the macro editor used to create and edit macros. You can also assign custom names to the macro buttons with this editor.

Creating a Macro from Terminal commands

You can create a macro from a sequence of terminal commands as follows:

1. Enter the sequence of commands.

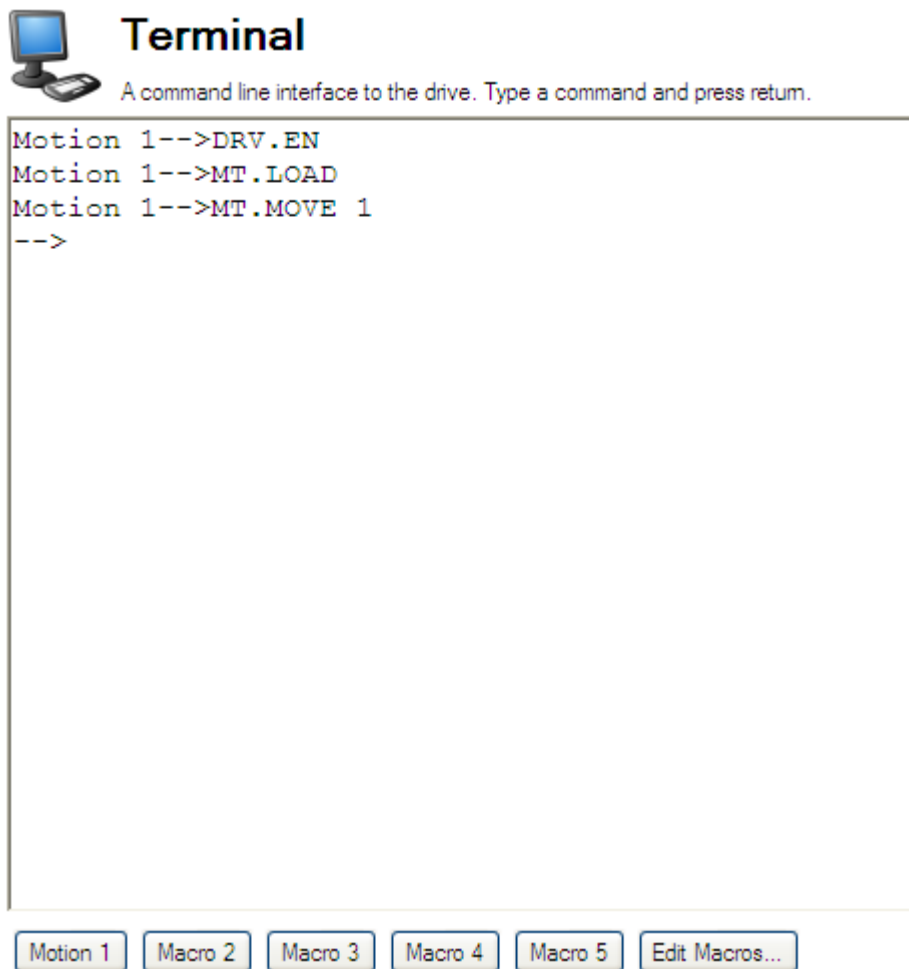

2. Copy the sequence of commands, then click **Edit Macro**. Select a macro from the tree on the left, then paste the sequence of commands into the Commands area of the Edit Macros window.

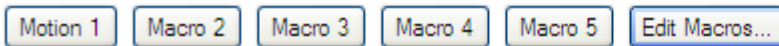
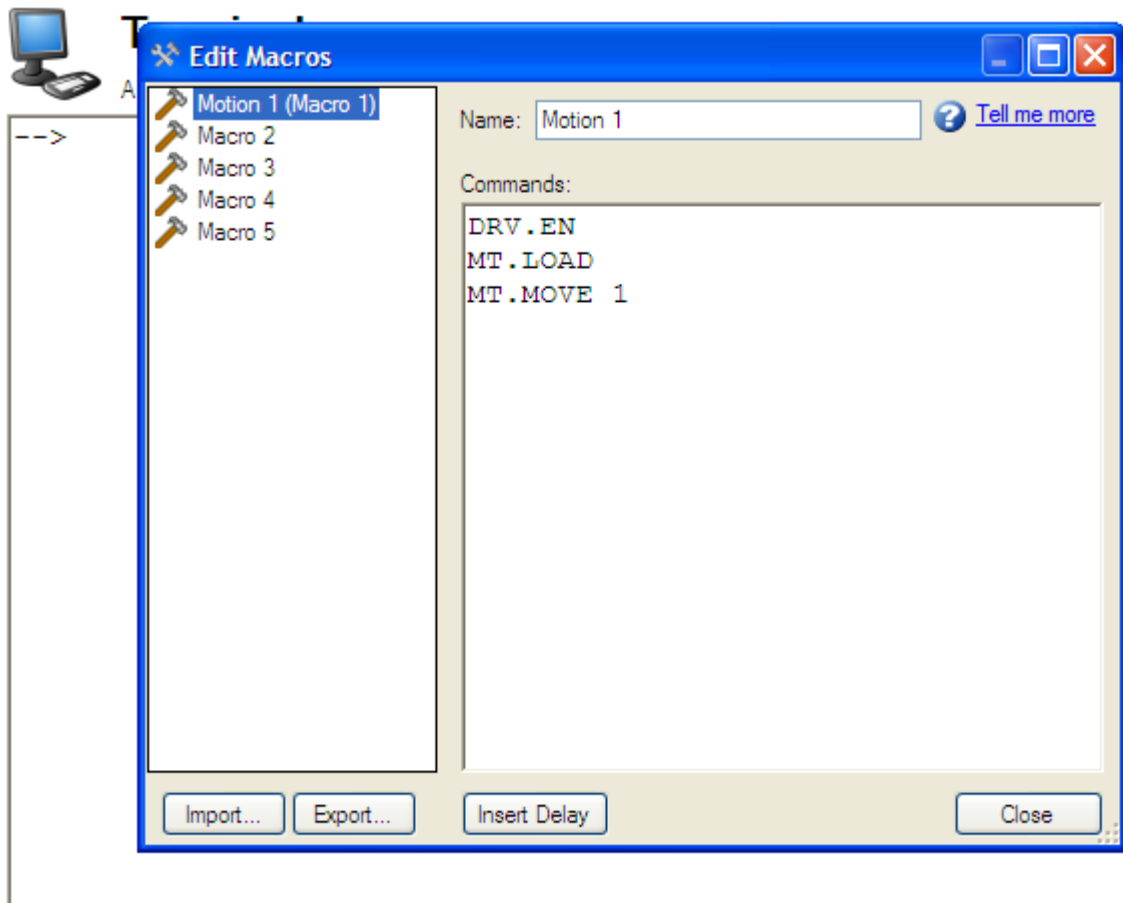

3. Select **Save** to save your macro.

Macro Editor

The macro editor allows you to create and modify up to five macros. EWV automatically saves the macros that you create. If you exit KAS IDE and then start KAS IDE again, the macros you defined will still be available.

To create or edit a macro from the editor, open the **Terminal** screen and click on **Edit Macros** (located at the bottom of the screen). Select the macro you wish to edit from the tree on the left, then use the features described below to build the macro. You can add comments in the macro after the ";" symbol.

Button or Dialog Box	Description
Name	Allows you to give each macro a unique name. This name will be shown on the button in the terminal view.
Commands	Displays the commands that are sent to the drive when you use this macro. The response from the drive is displayed in the terminal.
Import	Overwrites the selected macro with the contents of a macro file exported from another computer.
Export	Sends the selected macro to a text file so that you can import it into KAS IDE running on another computer.

Button or Dialog Box	Description
Insert Delay	Inserts a step into the macro that causes a delay for a specified number of milliseconds before continuing. A line that starts with #delay 5000 will pause the execution of the macro for 5000 milliseconds.
Close	Closes this window and returns to the terminal view.

14.2 Parameter List

This screen displays a list of the current values of all the parameters that the drive supports. You can sort some of the rows by clicking the column headers.



Parameters

This page lists all the current values of all the drive parameters on the drive.

Full Name	Value	Units	Parameter	Read/Write
Analog Input				
Analog input low pass filter cutoff freq...	5,000.000	Hz	AIN.CUTOFF	read-write
Analog input signal deadband	0.000	V	AIN.DEADBAND	read-write
Analog Input Deadband Mode	0 - Deadband		AIN.DEADBANDMO...	read-write
Analog input torque scale	0.001	Arms/V	AIN.ISCALE	read-write
Analog input mode	1 - Command Source		AIN.MODE	read-write
Analog input offset	0.000	V	AIN.OFFSET	read-write
Analog input position scale	0.000	Counts/16...	AIN.PSCALE	read-write
Analog input signal	0.000	V	AIN.VALUE	read-only
Analog input velocity scale	0.060	rpm/V	AIN.VSCALE	read-write
Analog Output				
Bode				
Bus Volts				
Controlled Stop				
Current Loop				
Digital Input				
Digital Output				
Drive				
Electronic Gearing				
Fieldbuses				
GUI Parameters				
Hardware Limit Switches				
Homing				
TCP/IP				
Motion Tasks				
Motor				
Position Capture				
Position Feedback				
Position Loop				
Programmable Limit Switches				
Recorder				
Regen Resistors				
Service Motion				
Software Limit Switches				
Units				
Velocity Loop				
Wake & Shake				
Misc				

Button or Dialog Box	Description
Refresh	Reads all the parameters from the drive and update the contents of the table.
Print	Sends the data that you see on the screen to the printer.
eMail	Opens an email message and attaches a comma separated file to the email message.

Button or Dialog Box	Description
More/Less	Adds two more columns to the table with the range and default values for each parameter.

14.3 Parameter Load/Save

To copy a configuration (all the device parameters that are stored in the device's nonvolatile memory) from one device to another, click the **Save to File** button on the first device and then use the **Load from File** on the second device. If you wish the second device to keep these new parameters after the device is turned off, then you can save the parameters to the nonvolatile memory with **Save To Device**.

Button or Dialog Box	Description
Save To File	Copies all the device parameters and creates a file.
Load From Device	Sets all the device parameters within the device to the values contained within the file you select.
Save to Device	Saves all device parameters into the nonvolatile memory of the device. Each time the device powers on, it will start with these saved parameters.
Default	Returns all the device parameters back to their default values. Any changes you have made are lost.

14.3.1 Loading an Incompatible File

If the parameter file from a different model type is loaded to an AKD PDMM, a warning will display notifying the user, but the load can still be performed.

15 Faults and Warnings

15.1	Fault and Warning Messages	174
15.2	Additional error and alarm messages AKD PDMM	192
15.3	Clearing Faults	194
15.4	Parameter and Command Error Messages	194
15.5	Unknown Fault	198

15.1 Fault and Warning Messages

When a fault occurs, the drive fault relay is opened, the output stage is switched off (motor loses all torque), or the load is dynamically braked. The specific drive behavior depends on the type of fault. The LED display on the front panel of the drive shows the number of the fault that occurred. If a warning is issued prior to the fault, the warning is shown on the LED and has the same number as the associated fault. Warnings do not trip the power stage of the drive or fault relay output.

The left side of the LED displays F for a fault or n for a warning. The right side displays the fault or warning number as follows: 1-0-1-[break]. The highest priority fault is displayed on the LED. Multiple faults may be present when a fault condition is occurring. Check the AKD PDMM [EWV¹](#) Fault Screen or read the status of DRV.FAULTS through the controller or HMI for the entire list of faults.

NOTE

Fault	Message/Warning	Cause	Remedy	Drive Response to Fault
F0		Reserved.	N/A	N/A
F101	Firmware incompatible.	Installed firmware is not compatible with the drive hardware.	Load compatible firmware into the drive.	Disable power stage
n101	The FPGA is a lab FPGA.	The FPGA is a lab version FPGA.	Load the released FPGA version that is compatible with the operational firmware.	None
F102	Resident Firmware failed.	Software failure detected.	Restart drive. If issue persists, contact technical support.	Disable power stage
n102	Operational FPGA is not a default FPGA.	The FPGA minor version is larger than the operational firmware default FPGA minor version	Load the released FPGA version that is compatible with the operational firmware.	None
F103	Resident FPGA failed.	Software failure detected. Load resident FPGA failure occurred (several cases according to flowchart, including incompatible image to FPGA type and fieldbus type).	Restart drive. If issue persists, contact technical support.	Disable power stage
F104	Operational FPGA failed.	Software failure detected. Load operational FPGA failure occurred (several cases according to flowchart).	Restart drive. If issue persists, contact technical support.	Disable power stage

¹Embedded Workbench Views

Fault	Message/Warning	Cause	Remedy	Drive Response to Fault
F105	NV Memory Stamp.	Non-volatile memory stamp is corrupted or invalid.	Reset the drive to default memory values using Parameter Load in EWW.	Disable power stage
F106	NV Memory Data (might occur when downloading firmware).	Non-volatile memory data is corrupted or invalid. When this fault occurs after a firmware download, it is not an indication of a problem (clear the fault and perform a "save" to the drive).	Reset the drive to default memory values using Parameter Load in EWW.	Disable power stage
n107	Positive switch.	Positive software position limit is exceeded.	Move the load away from the limits.	Controlled stop
n108	Negative switch.	Negative software position limit is exceeded.	Move the load away from the limits.	Controlled stop
F121	Homing Error.	Drive did not finish homing sequence.	Check homing sensor, homing mode, and homing configuration.	Controlled stop
F123 n123	Invalid motion task.	Invalid motion task.	Check motion task settings and parameters to make sure that the values entered will produce a valid motion task.	Disable power stage
F125 n125	Fieldbus Sync frames lost.	The fieldbus lost synchronization.	Check fieldbus connection (X5 and X6 if you are using EtherCAT; X12 and X13 if you are using CANopen) or the settings of your EtherCAT or CANopen master.	Controlled stop
F126 n126	Bode plot too much movement.	Too much movement was created during a Bode plot. Motor is unstable and is not following drive instructions.	Check that the system is closed loop stable. Refer to the system tuning guide.	Dynamic braking
F127	Incomplete Emergency Procedure.	Incomplete emergency stop procedure (problem with the emergency stop motion task).	Disconnect power from drive and check emergency stop procedure.	Dynamic braking
F128	Mpoles / Fpoles not integer.	Ratio of motor poles to feedback poles must be a whole number.	Change to a compatible feedback device.	Disable power stage

Fault	Message/Warning	Cause	Remedy	Drive Response to Fault
F129	Fieldbus Heartbeat lost.	Heartbeat lost.	Check CANopen cabling. Reduce bus load or increase the heartbeat update time.	Controlled stop
F130	Secondary feedback supply over current.	5V power supply was shorted out on X9.	Check X9 connection.	Disable power stage
F131	Secondary feedback A/B line break.	Problem in secondary feedback detected.	Check secondary feedback (X9 connection).	Disable power stage
F132	Secondary feedback Z line break.	Problem in secondary feedback detected.	Check secondary feedback (X9 connection).	Disable power stage
F133	Fault number changed to to F138. See F138 for details.			Disable power stage
F134	Secondary feedback illegal state.	Feedback signals were detected in an illegal combination.	Check X9 connection.	Disable power stage
F135 n135	Fault on FB2 is preventing remote commutation for FB1.	Attempt to issue motion task before the axis is homed. Axis must be homed before motion task can start.	Change opmode or home axis.	Disable power stage
F136	Firmware and FPGA versions are not compatible.	The FPGA version does not match the firmware FPGA version constants.	Load the FPGA version that is compatible with the firmware.	Disable power stage
n137	Homing and feedback mismatch	The configured homing mode is not supported by the motor feedback type used.	Change homing mode.	None
F138	Instability during auto-tune.	Drive current (IL.CMD) or velocity feedback (VL.FB) exceeds allowable limit (BODE.IFLIMIT or BODE.VFLIMIT). This fault only occurs in BODE.MODE 5. This fault often occurs when complex mechanics, belts, and compliant loads are present.	Change BODE.MODE if appropriate. If BODE.MODE 5 is appropriate and the fault occurs at the end of an Autotuning, then the motor is not robustly stable. You can manually adjust Autotuner settings. Manual tuning may be required to make the motor stable.	Controlled stop

Fault	Message/Warning	Cause	Remedy	Drive Response to Fault
F139	Target position was overshoot due to invalid motion task activation.	The drive cannot decelerate from its current speed to reach the end point of the second motion task without moving past it. Increase the deceleration rate in the move or trigger the move earlier.	Change Motion task profile and clear fault with <code>DRV.CLRFAULTS</code> . Or change the value of <code>FAULT139.ACTION = 1</code> to ignore this condition.	Disable power stage
n140	<code>VBUS.HALFVOLT</code> has changed. Save the parameters and reboot the drive.	The user has changed the numerical value of <code>VBUS.HALFVOLT</code> . This change only takes effect after a <code>DRV.NVSAVE</code> command and after rebooting the AKD PDMM.	Save the parameters in the non-volatile memory via a <code>DRV.NVSAVE</code> command and turn off/on the 24[V] power supply in order to reboot the drive or restore the original setting of <code>VBUS.HALFVOLT</code> .	None
n151	Not enough distance to move; motion exception.	For trapezoidal and customer table motion tasks: The target velocity specified in the motion task cannot be reached via using the selected acceleration and deceleration since the distance to travel is not sufficient. For a 1:1 profile: The selected acceleration and deceleration will be extended since there is too much distance to travel and the motion task would exceed its maximum allowed velocity.	Activation of any new motion or using of <code>DRV.CLRFAULTS</code> will clear the warning. Check motion task settings and parameters to make sure that the values entered will produce a valid motion task.	None

Fault	Message/Warning	Cause	Remedy	Drive Response to Fault
n152	Not enough distance to move; following motion exception.	A new motion task activated, when one motion task is already active and the target position specified in the motion task parameters cannot be reached with specified target velocity, acceleration and deceleration parameters. The motion task will directly decelerate to into the target position or ramps down to velocity 0 and start another move to reach target position of the next motion task.	Activation of any new motion or using of DRV.CLRFAULTS will clear the warning. Check motion task settings and parameters to make sure that the values entered will produce a valid motion task.	None
n153	Velocity limit violation, exceeding max limit.	A new target velocity calculated internally due to an exception, and is being limited due to user velocity limit.	Activation of any new motion or using of DRV.CLRFAULTS will clear the warning. Check motion task target velocity settings and parameters to make sure that the values entered will not exceed the VL.LIMITP and VL.LIMITN setting.	None
n154	Following motion failed; check motion parameters.	Activation of the following motion task failed due to incompatible parameters, or motion task does not exist.	Activation of any new motion or using of DRV.CLRFAULTS will clear the warning. Check following motion task settings and parameters to make sure that the values entered will produce a valid motion task.	None
n156	Target position crossed due to stop command.	The motion task crosses the target position after triggering a DRV.STOP command. This situation can happen when processing a change-on-the-fly motion task and triggering a DRV.STOP command close to the target position of the currently running motion task.	Activation of any new motion or using of DRV.CLRFAULTS will clear the warning.	None

Fault	Message/Warning	Cause	Remedy	Drive Response to Fault
n157	Homing index pulse not found.	A homing mode with index detection is activated, and index pulse is not detected while moving across the range determined by the hardware limit switches.	Activation of any new motion or using of DRV.CLRFAULTS will clear the warning.	None
n158	Homing reference switch not found.	A homing mode with reference switch detection is activated and the reference switch is not detected while moving across the range determined by the hardware limit switches.	Activation of any new motion or using of DRV.CLRFAULTS will clear the warning.	None
n159	Failed to set motion task parameters	Invalid motion task parameters assignment. This warning can appear upon an MT.SET command.	Activation of any new motion or using of DRV.CLRFAULTS will clear the warning. Check motion task settings and parameters.	None
n160	Motion task activation failed.	Activation of the motion task failed due to incompatible parameters, or motion task does not exist. This warning can appear upon an MT.MOVE command.	Activation of any new motion or using of DRV.CLRFAULTS will clear the warning. Check motion task settings and parameters to make sure that the values entered will produce a valid motion task.	None
n161	Homing procedure failed.	Homing error observed during the operation of homing procedure.	Activation of any new motion or using of DRV.CLRFAULTS will clear the warning.	None
n163	MT.NUM exceeds limit.	This warning appears with n160. This warning is triggered when you try to trigger a motion task > 128 (such as MT.MOVE 130).	Trigger only motion tasks between 0 and 128. Activation of any new motion or using of DRV.CLRFAULTS will clear the warning.	None
n164	Motion task is not initialized.	This warning appears with n160. This warning is triggered when you try to trigger a non-initialized motion task.	Initialize the motion task first before starting the task. Activation of any new motion or using of DRV.CLRFAULTS will clear the warning.	None

Fault	Message/Warning	Cause	Remedy	Drive Response to Fault
n165	Motion task target position is out.	This warning appears with n160. This warning is triggered when you try to trigger a motion task with an absolute target position outside of the selected modulo range (see also MT.CNTL).	Move the absolute target position of the motion task within the modulo range. Activation of any new motion or using of DRV.CLRFAULTS will clear the warning.	None
n168	Invalid bit combination in the motion task control word.	This warning appears with n160. This warning is triggered when you try to trigger a motion task with an invalid bit combination in the motion task control word (see also MT.CNTL).	Correct the MT.CNTL setting for the specific motion task. Activation of any new motion or using of DRV.CLRFAULTS will clear the warning.	None
n169	1:1 profile cannot be triggered on the fly.	This warning appears with n160. This warning is triggered when you try to trigger a 1:1 profile table motion task while another motion task is currently running.	1:1 profile table motion tasks should be started from velocity 0. Activation of any new motion or using of DRV.CLRFAULTS will clear the warning.	None
n170	Customer profile table is not initialized.	This warning appears with n160. This warning is triggered when you try to trigger a motion task that uses a customer profile table for generating the velocity profile and when the selected profile table is empty (see MT.CNTL and MT.TNUM).	Change the MT.TNUM parameter for this specific motion task in order to use an initialized profile table. Activation of any new motion or using of DRV.CLRFAULTS will clear the warning.	None
n175		Clamping torque not reached at fixed stop.	Check fixed stop configuration. Check if fixed stop is mounted properly.	None
F176		Fixed stop has broken off.	Check that fixed stop is mounted properly. If mounted properly, the fixed stop monitor window (MT.FIXEDSTOPMONITORWINDOW (→ p. 1)) is too small.	Disable power stage

Fault	Message/Warning	Cause	Remedy	Drive Response to Fault
F178		Axis reached the target position without stopping at fixed stop.	Check that fixed stop is mounted properly.	Disable power stage
F201	Internal RAM failed.	Hardware failure detected.	Restart drive. If issue persists, contact technical support.	Disable power stage
F202	External RAM failed.	Hardware failure detected.	Restart drive. If issue persists, contact technical support.	Disable power stage
F203	Code Integrity failed.	Software failure detected. FPGA register access failure occurred.	Restart drive. If issue persists, contact technical support.	Disable power stage
F20-4 to F23-2	EEPROM failure detected	EEPROM failure detected	Restart drive. If issue persists, exchange drive.	Disable power stage
F23-4- F237 n23-4- n237	Temperature sensor high.	High temperature limit reached.	Check cabinet ventilation system.	Disable power stage
F24-0- F243 n24-0- n243	Temperature sensor low.	Low temperature limit reached.	Check cabinet ventilation system.	Disable power stage
F245	External Fault.	This fault is user generated and is caused by user settings.	Users can configure a digital input to trigger this fault (DINx.MODE = 10). The fault occurs according to this input setting. Clear the input to clear the fault.	Disable power stage
F247	Vbus read is out of thresholds.	Hardware problem in bus measurement.	Troubleshoot and repair hardware problem.	Disable power stage
F248	Option board EEPROM corrupted.	EEPROM failure detected.	Restart drive. If issue persists, exchange drive.	Disable power stage
F249	Option board downstream checksum.	Communications with the I/O on the option board failed.	DRV.CLRFAULTS. If issue persists If issue persists, contact technical support.	Disable power stage

Fault	Message/Warning	Cause	Remedy	Drive Response to Fault
F250	Option board upstream checksum.	Communications with the I/O on the option board failed.	DRV.CLRFAULTS. If issue persists If issue persists, contact technical support.	Disable power stage
F251	Option board watchdog.	Communications with the I/O on the option board failed.	DRV.CLRFAULTS. If issue persists If issue persists, contact technical support.	Disable power stage
F252	Firmware and option board FPGA types are not compatible.	The option board FPGA is not compatible with this hardware.	Download the correct firmware file for this drive.	Disable power stage
F253	Firmware and option board FPGA versions are not compatible.	The version of the option board FPGA is not compatible with this firmware.	Download the correct firmware file for this drive.	Disable power stage
F301 n301	Motor overheated.	Motor overheated.	Check ambient temperature. Check motor mounting heat sink capability	Disable power stage
F302	Over speed.	Motor exceeded VL.THRESH value.	Increase VL.THRESH or lower velocity command.	Dynamic braking
F303	Run away.	Motor did not follow command values.	Current command to the motor is too high for too long. Reduce servo gains, or reduce command trajectory aggressiveness.	Controlled stop
F304 n304	Motor Foldback.	Maximum motor power has been exceeded; the power has been limited to protect the motor	Motion is requiring too much power. Change move profile to reduce load on motor. Check for load jamming or sticking. Check that current limits are set correctly.	Controlled stop
F305	Brake open circuit.	Motor brake open circuit. Fault threshold is 200 mA.	Check cabling and general functionality. For special low current brake applications, the F305 fault can be bypassed using the setting motor.brake = 100.	Dynamic braking
F306	Brake short circuit.	Motor brake short circuit.	Check cabling and general functionality.	Dynamic braking
F307	Brake applied during Enable-State.	Motor brake closed unexpectedly.	Check cabling and general functionality.	Dynamic braking
F308	Voltage exceeds motors rating.	Drive bus voltage exceeds the motor's defined voltage rating.	Make sure that the motor fits the driving rating.	Disable power stage

Fault	Message/Warning	Cause	Remedy	Drive Response to Fault
n309	Motor I2t load. reduce load	Motor I2t load (IL.MI2T) has exceeded the warning threshold IL.MI2TWTHRESH. - This warning can only be generated in the case that the motor protection mode IL.MIMODE has been set to 1.	Reduce the load of the drive by adjusting lower acceleration / deceleration ramps.	None
F312	Brake released when it should be applied.	Brake disengaged unexpectedly.	Check cabling and general functionality.	Controlled stop
F401	Failed to set feedback type.	Feedback is not connected or wrong feedback type selected	Check primary feedback (X10 connection).	Dynamic braking
F402	Analog signal amplitude fault.	Analog signal amplitude is too low. Analog fault (resolver signal amplitude or sin/cos amplitude)	Check primary feedback (X10 connection), resolver and sine/cos encoder only.	Dynamic braking
F403	EnDat communication fault.	General communication problem with feedback.	Check primary feedback (X10 connection), EnDat only	Dynamic braking
F404	Illegal Hall state (111, 000).	Hall sensor returns invalid Hall state (111, 000); either all Hall sensors are on or off. Legal Hall states are 001, 011, 010, 110, 100, and 101. This fault can be caused by a broken connection in any one of the Hall signals.	Check the feedback wiring; check all feedback connectors to ensure all pins are positioned correctly.	Dynamic braking
F405	BiSS watchdog fault.	Bad communication with the feedback device.	Check primary feedback (X10 connection), Biss only.	Dynamic braking
F406	BiSS multi cycle fault.			
F407	BiSS sensor fault.			
F408- F416	SFD feedback fault.	Bad communication with the SFD device.	Check primary feedback (X10 connection). If fault persists, internal feedback failure. Return to manufacturer for repair.	Dynamic braking

Fault	Message/Warning	Cause	Remedy	Drive Response to Fault
F417	Broken wire in primary feedback.	In primary feedback, a broken wire was detected (incremental encoder signal amplitude).	Check feedback cable continuity.	Dynamic braking
F418	Primary feedback power supply.	Power supply fault for primary feedback.	Check primary feedback (X10 connection).	Dynamic braking
F419	Encoder init procedure failed.	Phase find procedure did not complete successfully.	Check encoder wiring, reduce/balance motor load prior to phase finding.	Disable power stage
F420	FB3 Endat communication fault.	A communication error was detected with the EnDat 2.2 device connected to the X9 connector.	Check pinout and FB3 configuration and reconnect feedback. If problems persist, contact customer support.	Dynamic braking
F421	SFD resolver sensor fault.	Sensor or sensor wiring failure inside motor.	Try resetting the fault. If it reappears return motor for repair.	Dynamic braking
F423	NV Failure – Multiturn Overflow.	The position saved in memory is corrupted.	Home axis or disable multiturn overflow. If the fault persists, send the drive for repair.	Disable power stage
F438 n439	Deviation from predicted trajectory fault.	Motor did not follow command values. Motor exceeded maximum allowed position following error (numeric).	Check for increased load, jamming or sticking. Is position error set too low?	Controlled stop
F439 n439	Following error magnitude fault.	Motor did not follow command values. Motor exceeded maximum allowed position following error (user).	Check feedback commutation setup and tuning parameters.	Controlled stop
F450	Following error presentation.	Motor did not follow command values. Motor exceeded maximum allowed position following error (presentation).	Check feedback commutation setup and tuning parameters.	Controlled stop

Fault	Message/Warning	Cause	Remedy	Drive Response to Fault
F451 n451	Feedback battery fault.	The external battery voltage is too low. The F451 fault is generated if the AKD PDMM is not powered. The n451 warning is generated if the AKD PDMM is powered. This fault can be inhibited with FAULT451.ACTION.	Check or replace the external battery.	Dynamic braking
F452	Multiturn overflow not supported with this feedback.	Non-multiturn feedback is connected while FB1.PMTSAVEEN is active.	Connect multiturn feedback to the drive or disable multiturn overflow.	Disable power stage
F453	Tamagawa communication fault (timeout).	Bad communication with the feedback device. Cabling or shielding fault, or internal feedback failure.	Check the cabling to the drive and if the problem persists then return the feedback to the manufacturer for repair.	Dynamic braking
F454	Tamagawa communication fault (transfer incomplete).			
F456	Tamagawa communication fault (CRC).			
F457	Tamagawa communication fault (start timeout).			
F458	Tamagawa communication fault (UART Overrun).			
F459	Tamagawa communication fault (UART Framing).			
F460	Tamagawa encoder fault (over speed).	This fault is generated when the shaft is rotated above a maximum speed that can be maintained while the external battery is powered and the drive is powered off.	Reset the fault on the drive with DRV.CLRFAULTS.	Dynamic braking

Fault	Message/Warning	Cause	Remedy	Drive Response to Fault
F461	Tamagawa encoder fault (counting Error).	When the feedback is powered on the position (within one revolution) was incorrect because of a problem with the feedback device.	Reset the fault on the drive with DRV.CLRFAULTS, if the problem persists then clean the feedback code plate.	Dynamic braking
F462	Tamagawa encoder fault (counting overflow).	Multi-turn counter has overflowed.	Reset the fault on the drive with DRV.CLRFAULTS.	Dynamic braking
F463	Feedback overheat fault.	The temperature of the encoder substrate exceeds overheating detection temperature during main power-on.	Reset the fault on the drive with DRV.CLRFAULTS after temperature of encoder is lowered.	Dynamic braking
F464	Tamagawa encoder fault (multi-turn error).	Any bit-jump occurs in the multi-turn signal during main power-on.	Return to the origin. Reset the fault on the drive with DRV.CLRFAULTS.	Dynamic braking
F465	Excessive shock detected by feedback device.	1. Excessive shock from an impact or vibration has caused an error in the feedback device. or 2. Internal error in the feedback device mechanism, resulted in bad position data.	1. Reduce external impacts to the motor housing and shaft. Tune the control loops filters. Reduce gains, particularly feed forward gains. Reduce maximum commanded acceleration. or 2. Replace the feedback device.	Dynamic braking
F467	Feedback fault on feedback 1 (See FB1.FAULTS for details).	The feedback device malfunctioned.	Check FB1.FAULTS for detailed fault information. If using a BiSS feedback device, fault 467 indicates a communications fault with the BiSS feedback device. No additional information is available via FB1.FAULTS for this fault when using a BiSS feedback device.	Dynamic braking
F469	FB1.ENCRES is not power of two, Remote Commutation not possible.	Feedback Type 43 requires that the feedback resolution be a power of two. Feedback Type 43 is not supported for all feedback resolutions.	If the remote feedback device's resolution is a power of two, enter that value in FB1.ENCRES. Otherwise, choose a feedback device with a supported resolution (power of two) and enter that value in FB1.ENCRES.	Dynamic braking

Fault	Message/Warning	Cause	Remedy	Drive Response to Fault
F470	Feedback fault on feedback 3.	Feedback is not connected or general communication problem.	Check tertiary feedback (X9 connection)	Dynamic braking
F480	Field bus command velocity too high.	Fieldbus command velocity exceeds VL.LIMITP.	Lower fieldbus command trajectory, or increase the value of VL.LIMITP.	Disable power stage
F481	Field bus command velocity too low.	Fieldbus command velocity exceeds VL.LIMITN.	Increase fieldbus command trajectory, or decrease the value of VL.LIMITN.	Disable power stage
F486	Input change rate exceeds maximum speed of emulated encoder.	Motor velocity exceeds the maximum speed the emulated encoder output can generate.	Reduce value of DRV.EMUEPULSEWIDTH.	Controlled stop
F493	Invalid commutation detected - motor accelerating in the wrong direction. Motor phase may be incorrect.	The velocity of the motor exceeded WS.CHECKV and the sign of the current was not equal to the sign of motor acceleration or the sign of motor velocity for a period of time larger than WS.CHECKT.	<ol style="list-style-type: none"> 1. Check motor phase wiring 2. Re-configure wake and shake (if Mode 0 or 1 is used) 3. Re-run wake and shake to determine correct commutation angle 	Dynamic braking
F501 n501	Bus over voltage.	Bus voltage too high. Usually, this problem is load related.	Reduce load or change motion profile. Check system regen capacity; add capacity if needed. Check mains voltage.	Disable power stage
F502	Bus under voltage. Warning issued prior to fault.	Bus voltage below threshold value.	Check mains voltage.	Controlled stop
F503 n503	Bus capacitor overloaded.	Single phase AC input on a drive only rated for three-phase input or excessive single-phase power load.	Check mains voltage.	Controlled stop
F504- F518	Internal supply voltage fault	Internal supply voltage fault detected	Check wiring for electromagnetic compatibility (EMC). If issue persists exchange drive.	Controlled stop
F519	Regen short circuit.	Regen resistor short circuit.	Regen IGBT short circuit. Contact technical support.	Disable power stage

Fault	Message/Warning	Cause	Remedy	Drive Response to Fault
F521 n521	Regen over power.	Too much power stored in regen resistor.	Either get larger regen resistor or use DC bus sharing to dissipate power.	Disable power stage
F523	Bus over voltage FPGA.	Bus over voltage hard fault.	Check mains voltage and check system brake capacity.	Disable power stage
F524 n524	Drive Foldback.	Maximum drive power has been exceeded. The power has been limited to protect the drive.	Motion requires too much power. Change profile to reduce load .	Controlled stop
F525	Output over current.	Current exceeds drive peak.	Check for short or feedback faults.	Disable power stage
F526	Current sensor short circuit.	1. Current sensor short circuit. 2. Motor cable plugged in upside down	1. Restart drive. If issue persists, contact technical support. 2. Plug in cable right-side up.	Disable power stage
F527	Iu current AD converter stuck.	Hardware failure detected.	Restart drive. If issue persists, contact technical support.	Disable power stage
F528	Iv current AD converter stuck.	Hardware failure detected.	Restart drive. If issue persists, contact technical support.	Disable power stage
F529	Iu current offset limit exceeded.	Hardware failure detected.	Restart drive. If issue persists, contact technical support.	Disable power stage
F530	Iv current offset limit exceeded.	Hardware failure detected.	Restart drive. If issue persists, contact technical support.	Disable power stage
F531	Power stage fault.	Hardware failure detected.	Restart drive. If issue persists, replace drive.	Disable power stage

Fault	Message/Warning	Cause	Remedy	Drive Response to Fault
F532	Drive motor parameters setup incomplete.	Before a motor can be enabled, you must configure a minimum set of parameters. These parameters have not been configured.	Issue the command <code>DRV.SETUPREQLIST</code> to display the list of the parameters that you must configure. Configure these parameters either manually or automatically. You can manually configure these parameters in three ways: (1) set each parameter individually; (2) use the setup wizard to select the motor; or (3) select the motor type from the motor data base in the Motor window (<code>MOTOR.AUTOSSET</code> must be set to 0 (off)). If you use the Motor window, you must first select the feedback type. If the motor has Biss Analog, Endat, or SFD feedback (feedback with memory), then these parameters are set automatically when <code>MOTOR.AUTOSSET</code> is set to 1 (on).	Disable power stage
F534	Failed to read motor parameters from feedback device.	Motor either does not have motor feedback memory, or the motor feedback memory is not programmed properly so the parameters cannot be read.	Try to read parameters again by clicking the Disable and Clear Faults button, or by issuing the <code>DRV.CLRFAULTS</code> command. If this attempt is not successful, then set <code>MOTOR.AUTOSSET</code> to 0 (off) and program the parameters using the setup wizard or manually set up the parameters. If the motor has motor memory (Biss Analog, Endat, and SFD motors have motor memory), return the motor to have the memory programmed.	Dynamic braking
F535	Power-board over-temperature fault.	The power-board temperature sensor indicates more than 85 °C.	Reduce the load of the drive or ensure better cooling.	Disable power stage
F537	Precharge fault.	Precharge process could not be performed in a reasonable amount of time.	Look for a shortcut in the string (cable) or exchange hardware	Disable Drives and Unpower Strings

Fault	Message/Warning	Cause	Remedy	Drive Response to Fault
F541	AC input phase 1 missing.	Mains supply failure detected, phase L1 missed.	Check power connector and power source.	Disable Drives and Unpower Strings
F542	AC input phase 2 missing.	Mains supply failure detected, phase L2 missed.	Check power connector and power source.	Disable Drives and Unpower Strings
F543	AC input phase 3 missing.	Mains supply failure detected, phase L3 missed.	Check power connector and power source.	Disable Drives and Unpower Strings
F560	Regen near capacity, could not prevent over voltage.	An F501 Bus Over Voltage has occurred while the Regen Resistor was at or above 75% of its dissipation capacity.	Increase the size of regen resistor to be able to dissipate more power.	Disable power stage
F570	Phase loss.	Phase loss detected.	Check mains power voltage. Fault action configurable by FAULT570.ACTION (→ p. 433).	Disable power stage
n582	Velocity has been limited commutation speed to less than 600Hz to meet ECCN 3A225 requirements.	Motor Velocity has exceeded the allowed commutation speed (599Hz).	Refer to ECCN 3A225 Limitations for Induction Motors.	Velocity command will be clamped at ECCN 3A225 regulation.
n601	Modbus data rate is too high.	Modbus controller data rate is too high.	Reduce data rate.	Disable power stage
F602	Safe torque off.	Safe torque off function has been triggered.	Reapply supply voltage to STO if safe to do so.	Disable power stage
n603	OPMODE incompatible with CMDSOURCE	This warning is generated when the drive is enabled and the gearing command source is selected at the same time as torque or velocity op-mode.	Select a different DRV.OPMODE and DRV.CMDSOURCE combination.	Disable power stage

Fault	Message/Warning	Cause	Remedy	Drive Response to Fault
n604	EMUEMODE incompatible with DRV.HANDWHEELS-RC.	Emulated encode mode is incompatible with the selected handwheel source.	Select a compatible emulated encode mode or change handwheel source.	Disable power stage
F621	Control Board CRC fault.	Communications with the Power Board Failed	DRV.CLRFAULTS. If issue persists, contact technical support.	Disable power stage
F623	Power Board CRC fault.			
F624	Power Board Watchdog fault.			
F625	Power Board Communication fault.			
F626	Power Board FPGA not configured.			
F627	Control Board Watchdog fault.			
F630	FPGA cyclic read fault.	FPGA-to-firmware data access error.	DRV.CLRFAULTS. If issue persists, contact technical support.	Disable Power Stage
F701	Fieldbus Runtime.	Runtime communication fault.	Check fieldbus connections (X11), settings, and control unit.	Controlled stop
F702 n702	Fieldbus Communication lost.	All fieldbus communication was lost.	Check fieldbus connections (X11), settings, and control unit.	Controlled stop
F703	Emergency timeout occurred.	Motor did not stop in the timeout defined.	Change timeout value, change stop parameters, improve tuning.	Disable power stage

15.2 Additional error and alarm messages AKD PDMM

Faults/Errors and Warnings/Alerts are displayed in the 7 segment displays of the drive:

AKD PDMM two digits	AKD PDMM-M two + one digits
	
<p>The two digits LED display indicates the drive messages. Drive fault messages are coded with "F", warnings are coded with "n" and are described in "Fault and Warning Messages" (=> p. 1)</p>	<p>The one digit LED indicates the PDMM messages of the AKD PDMM. Error messages are coded with "E", alarms are coded with "A" and are described in the chapter below.</p>

To simplify handling, the error and alarm handling process is consistent, so you can always apply the same recovery steps. When an error or alarm occurs, it is displayed to the one digit display, you can identify the error in the table below and follow the recommendations to fix the problem, clear the display, and resume machine operation.

Active errors and alarms can be cleared with the controller command **ClearCtrlErrors**, (Note: non-clearable errors will remain).

15.2.1 Alarms

Alarm	Description
A01	High temperature exceeded
A02	Low on memory.
A04	Low input voltage
A12	Flash memory is low on free space.
A21	Recoverable process or thread failed to respond during operation.
A23	CPU is overloaded
A30	EtherCAT missed a send frame during operation mode.
A38	EtherCAT missed a receive frame during operation mode.
A40	Local digital IO missed a cyclic update
A53	AKD PDMM-M-MC was replaced with the higher performance M1 model.

15.2.2 Errors

When an Error or Alarm occurs, always check the controller log messages. The log messages will provide more details about the failure and the history of events leading up to the failure. From the log messages, you can determine the specifics about the cause of the failure to correct the underlying problem.

NOTE

More information about error and alarm messages, causes, remedy and clearing errors can be found in the [EWW¹](#) online help.

Error	Description
E01	Critical temperature exceeded. PDMM operation is stopped, CPU will be put to sleep.
E02	Out of memory. KAS runtime is stopping.
E03	Fan failure.
E10	Firmware is corrupted.
E11	Flash is corrupted, no filesystem is available.
E12	Not enough flash memory available.
E13	Out of NVRAM space for retained variables.
E14	Reset to Factory Defaults failed.
E15	Cannot read/write files from/to a SD card.
E16	Not enough space available on the SD card.
E20	Runtime plug-in, process, thread or application failed to start.
E21	Runtime plug-in, process, or thread failed to respond during operation.
E22	Fatal error in PLC program, application stopped.
E23	CPU is overloaded.
E24	PLC application cannot be started
E30	EtherCAT communication failure during operational mode.
E31	EtherCAT communication failure during preop mode.
E32	EtherCAT communication failure during bootstrap mode.
E33	EtherCAT failed to initialize into operational mode.
E34	EtherCAT failed to initialize into preop mode.
E35	EtherCAT failed to initialize into bootstrap mode.
E36	EtherCAT network discovery failed.
E37	EtherCAT failed to return to init state.
E50	Backup to SD card failed.
E51	Restore from SD card failed..
E52	SD Backup files are missing or corrupt.
E53	SD Backup files are not compatible.

¹Embedded Workbench Views

15.3 Clearing Faults

You can clear drive faults in three ways: 1. using the EWV¹ toolbar; 2. using the EWV Faults screen, 3. using an external digital signal. Clearing the fault automatically disables the drive (by issuing the DRV.DIS command). After the fault is cleared, you must then enable the drive again (by issuing the DRV.EN command). Using external digital signal, clearing the fault does not automatically disable the drive. Once the fault is cleared, the drive will immediately become enabled again when no fault conditions exist.

The external digital signal method is useful when the application does not require a field bus, therefore the controller cannot issue fieldbus commands (for example, DRV.EN). The fault clearing function is simpler in this case. The controller can clear a fault condition with a single output and no fieldbus command is required. The hardware enable input is still utilized for safety. Many machines are set to disable when a fault occurs, therefore, the enable circuit is connected only after the fault clear circuit is toggled.

1. Using the EWV toolbar. Click the **Clear Fault** button to clear the fault, then click the **Enable** button to enable the drive again.

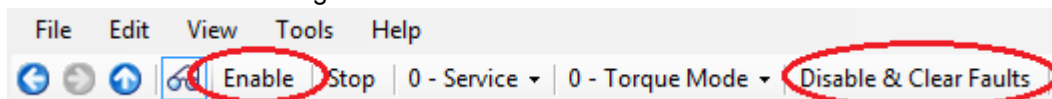

2. Using an ASCII command. In EWV terminal screen, enter DRV.CLRFAULTS, then enter DRV.EN to enable the drive.
3. Using an external digital signal. First, provide a disable command to the drive, since this command is not automatically issued when the fault is cleared using an external digital signal. You must provide this disable command after the drive has disabled itself and before the clear fault command is issued in order for the clear fault command to be accepted.

Digital input mode 1 clears a fault condition. In the EWV terminal screen, enter DINx.MODE 1, with x set to the corresponding digital input number. See the AKD PDMM Installation Manual (Digital Inputs (X7/X8) (→ p. 1)) for digital input numbers and corresponding pin connections.

Example:

DIN2.MODE 1 sets digital input 2 (pin 9 on connector X7) to perform the clear fault function. Any free digital input shown in Table x can be set to mode 1 (Reset faults).

15.4 Parameter and Command Error Messages

Error Message	Meaning	Remedy	Occurrence
Error: Parameter or command was not found.	Parameter or command string was not recognized as a known command.	Check the entered string for accuracy. Consult the reference guide or enter DRV.LIST in the <u>EWV</u> ² terminal screen to find valid parameters and commands.	General.
Error: Not a trigger parameter.	Parameter cannot be used for triggering the scope.	Use a different parameter as a trigger value.	Recorder parameters.
Error: Parameter not recordable.	Parameter cannot be scoped.	Do not scope this parameter.	Recorder parameters.

¹Embedded Workbench Views

²Embedded Workbench Views

Error Message	Meaning	Remedy	Occurrence
Error: Wrong argument for parameter or command.	Argument was not accepted.	Check the entered argument for accuracy. Consult the reference guide or enter DRV.LIST in the EWV terminal screen to find valid parameter and command arguments.	General.
Error: No arguments allowed for parameter or command.	Parameter or command supports no arguments.	Enter parameter or command again with no arguments.	Commands and read-only parameters
Error: Too many arguments for parameter or command.	Too many arguments provided for this parameter or command.	Enter again with fewer arguments.	All parameters and commands with no or one argument.
Error: No float allowed.	Float number was entered, but only integer numbers are allowed.	Enter integer value instead.	All parameters and commands with integer arguments.
Error: Parameter or command is read-only.	Argument was not accepted because the parameter or command is read-only.	Enter again with no arguments.	Commands and all read-only parameters.
Error: Parameter is temporarily write protected.	Argument was not accepted because the parameter is currently read-only.	Check reference guide or KAS IDE help to determine if the parameter is read-only, read-write, or nonvolatile.	Some parameters that come from the Smart Feedback Device (SFD).
Error: Argument greater than maximum value.	Entered argument was beyond maximum value.	Enter a value that is within the allowable range. See reference guide or KAS IDE help for ranges.	Commands and read-write parameters.
Error: Too many characters in parameter or command.	Parameter or command string was too long.	Shorten string and enter again.	General.
Error: Argument less than minimum value.	Entered argument was too small.	Enter value that is within the limits.	Commands and read-write parameters.
Error: Argument is out of data range.	Entered argument was not within the data range limits.	Enter value that is within the limits.	Commands and read-write parameters.
Error: Parameter or command is password protected.	Use of this parameter or command requires a password.	Contact technical support to obtain password. Enter valid password.	Password protected parameters and commands.

Error Message	Meaning	Remedy	Occurrence
Error: Wrong operation mode for parameter or command.	Requested parameter or command cannot be performed in this operation mode.	Change to valid operation mode.	
Error: Drive enabled. Disable drive and continue.	Action can only be performed if drive is disabled.	Disable drive and repeat action.	
Error: Drive disabled. Enable drive and continue.	Action can only be performed if drive is enabled.	Enable drive and repeat action.	
Error: Data value is invalid.	Entered data was not valid.	Provide valid data.	
Error: Argument must be an even number.	Argument is not an even number.	Enter a value divisible by two without remainder.	
Error: Argument must be an odd number.	Argument must be an odd number.	Enter a value not divisible by two with remainder.	
Error: Axis is not homed.	Axis is not homed.	Home axis and repeat action.	
Error: All recorder channels empty.	No data is specified to record.	Specify the data to be recorded and start again.	Recorder commands.
Error: Process already active.	Required action is already running.	Wait until action is finished and start again if needed.	
Error: Motor is currently in motion.	Action can only be performed if motor is not moving.	Stop motion and repeat action.	Motion tasks, service motion, and others.
Error: EEPROM is bad or does not exist.	EEPROM is damaged.	Restart drive. If fault persists, replace the drive and consult technical support.	
Error: Unknown board.			
Error: Fault exists. Correct fault condition and then clear faults.	A fault is present in the system.	Clear the fault, disable the drive, and then enable the drive again.	
Error: Cannot clear faults. Issue software or hardware disable first.		Clear hardware or software enable and repeat action.	
Error: EEPROM is busy.			

Error Message	Meaning	Remedy	Occurrence
Error: Invalid motor/feedback poles ratio.			
Error: Unknown Fault.	Situation should not happen.	Clear fault. If fault recurs, consult technical support.	Unknown.
Error: Invalid motor/feedback poles ratio.			
Error: Invalid motion task parameter.			
Error: Invalid motion task number.			
Error: Invalid motion task velocity.			
Error: Invalid motion task acceleration or deceleration.			
Error: Invalid motion task customer profile table number.			
Error: Invalid motion task following number.			
Error: Function not available for the active command source.			
Error: Invalid Bode plot mode for this function.			
Error: Invalid sine-sweep Bode plot mode.			
Error: Bode plot start frequency greater than or equal to end frequency.			
Error: Function not available while a controlled stop is in process.			

Error Message	Meaning	Remedy	Occurrence
Error: Not enough memory available.			
Error: Function not available while a Bode-plot measurement is active.			
Error: Iu/Iv offset calculation not finished.			
Error: Buffer overflow.			
Error: Cannot save to EEPROM while inrush relay is closed.			
Error: Test mode is off.			
Error: Cannot change digital input mode. Issue software or hardware disable first.			
Error: Internal drive procedure active: controlled stop, burn-in, phase find, or zero.			
Error: General motion fault.			

15.5 Unknown Fault

This fault message occurs when an undefined fault condition is encountered.

15.5.1 Remedies

1. Click **Clear Fault**.

16 Troubleshooting the AKD PDMM

Drive problems occur for a variety of reasons, depending on the conditions in your installation. The causes of faults in multi-axis systems can be especially complex. If you cannot resolve a fault or other issue using the troubleshooting guidance presented below, customer support can give you further assistance.

Problem	Possible Causes	Remedy
HMI message: Communication fault	<ul style="list-style-type: none"> wrong cable used, cable plugged into wrong position on drive or PC wrong PC interface selected 	<ul style="list-style-type: none"> plug cable into the correct sockets on the drive and PC select correct interface
Drive does not enable	<ul style="list-style-type: none"> HW Enable not wired HW or SW Enable not set 	<ul style="list-style-type: none"> connect HW Enable (X8 pin 4) Apply 24V to HW Enable and select SW Enable in <u>EWV</u>¹ / Fieldbus
Motor does not rotate	<ul style="list-style-type: none"> drive not enabled software enable not set break in setpoint cable motor phases swapped brake not released drive is mechanically blocked motor pole no. set incorrectly feedback set up incorrectly 	<ul style="list-style-type: none"> apply ENABLE signal set software enable check setpoint cable correct motor phase sequence check brake control check mechanics set motor pole no. set up feedback correctly
Motor oscillates	<ul style="list-style-type: none"> gain is too high (speed controller) feedback cable shielding broken AGND not wired up 	<ul style="list-style-type: none"> reduce VL.KP (speed controller) replace feedback cable join AGND to CNC-GND
Drive reports following error	<ul style="list-style-type: none"> I_{rms} or I_{peak} set too low current or velocity limits apply accel/decel ramp is too long 	<ul style="list-style-type: none"> verify motor/drive sizing verify that IL.LIMITN/P, VL.LIMITN/P are not limiting the drive reduce DRV.ACC/DRV.DEC
Motor overheating	<ul style="list-style-type: none"> motor operating above its rating motor current settings incorrect 	<ul style="list-style-type: none"> verify motor/drive sizing verify motor continuous and peak current values are set correctly
Drive too soft	<ul style="list-style-type: none"> K_p (speed controller) too low K_i (speed controller) too low filters set too high 	<ul style="list-style-type: none"> increase VL.KP (speed controller) increase VL.KI (speed controller) refer to documentation regarding reducing filtering (VL.AR*)

¹Embedded Workbench Views

Problem	Possible Causes	Remedy
Drive runs roughly	<ul style="list-style-type: none"> • Kp (speed controller) too high • Ki (speed controller) too high • filters set too low 	<ul style="list-style-type: none"> • reduce VL.KP (speed controller) • reduce VL.KI (speed controller) • refer to documentation regarding increasing filtering (VL.AR*)
During installation, the message "Please wait while the installer finishes determining your disk space requirements" appears and never disappears.	<ul style="list-style-type: none"> • MSI installer issue. • Harddisk space not sufficient 	<ul style="list-style-type: none"> • Cancel the installation and relaunch the installer (you may need to try several times, the problem is random). • Make sure that you have enough disk space on your hard disk (~500MB).

17 Connection Diagrams

17.1	Connection diagram	202
17.2	Connection diagram	203
17.3	Connection diagram	205
17.4	24 V auxiliary supply (X1)	206
17.5	Motor Power Connection (X2)	206
17.6	External regen resistor (X3)	208
17.7	DC Bus link (X3, X14)	211
17.8	Mains supply connection (X3, X4)	214
17.9	I/O Connection	216
17.10	Analog Output (X8)	218
17.11	Analog Input (X8)	219
17.12	Command encoder signal connection	220
17.13	Pulse / Direction signal connection	222
17.14	CW / CCW signal connection	223
17.15	Feedback connector (X10)	224
17.16	Feedback connector (X9)	225
17.17	Feedback connector (X7)	225

17.1 Connection diagram

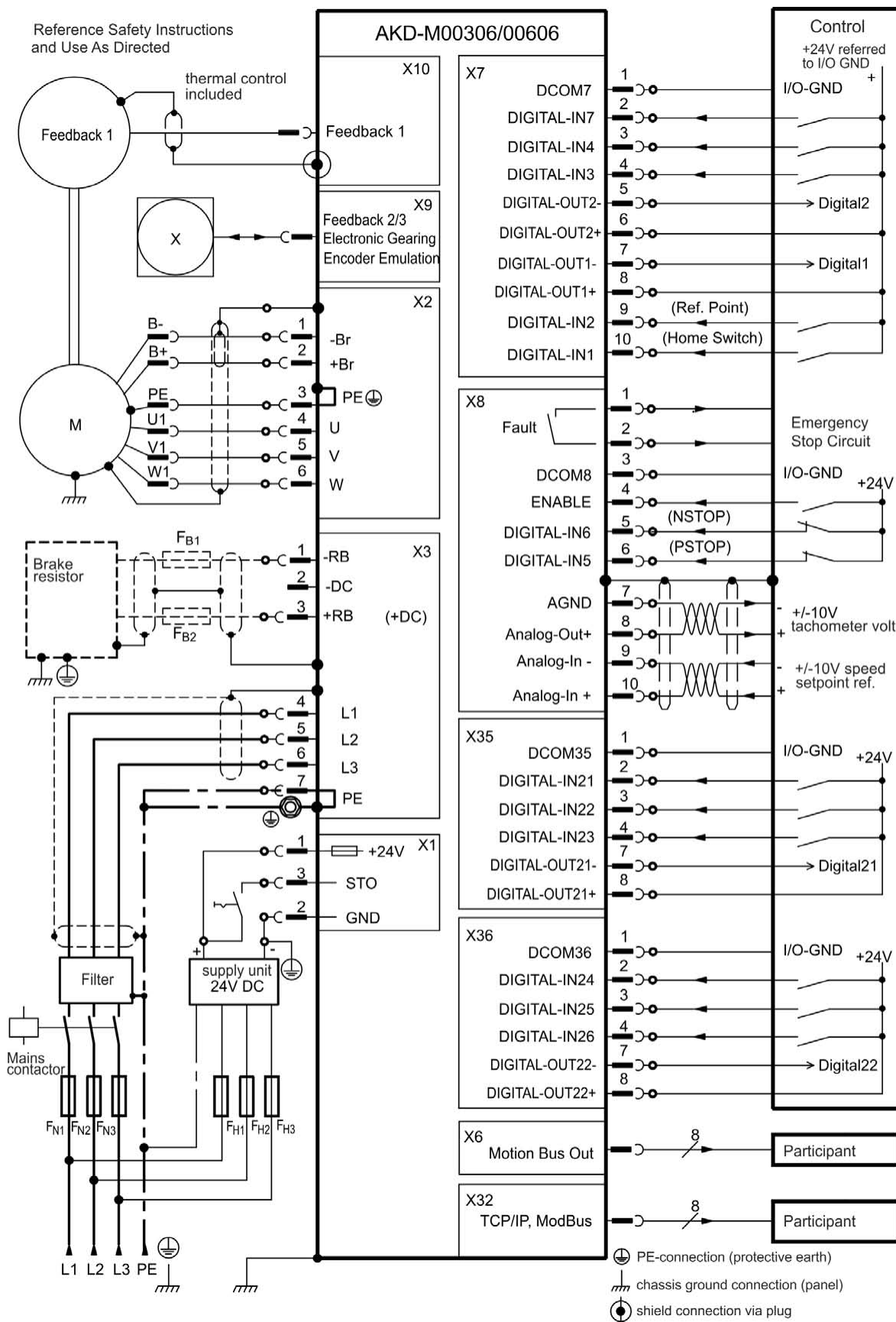

17.2 Connection diagram

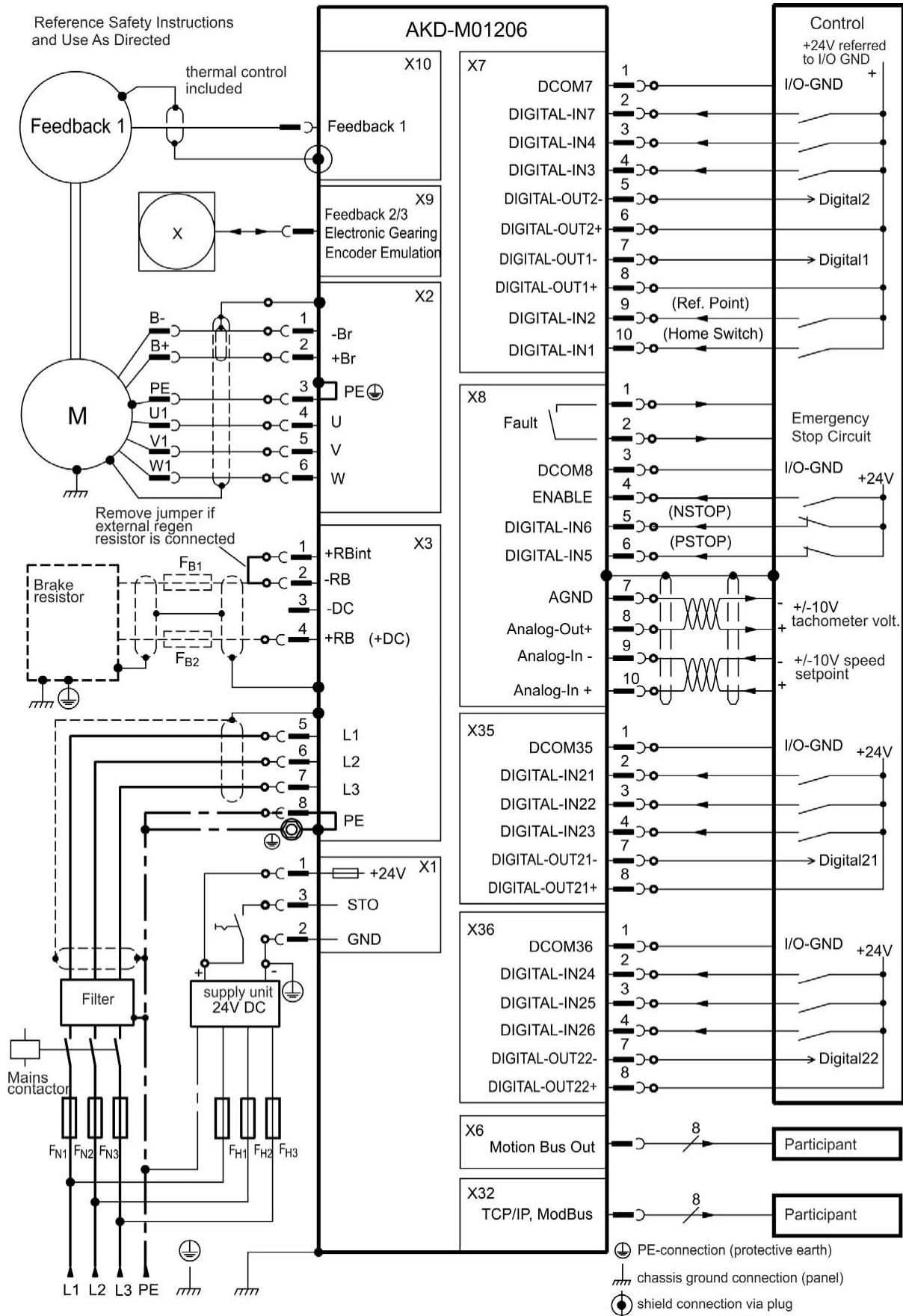

17.3 Connection diagram

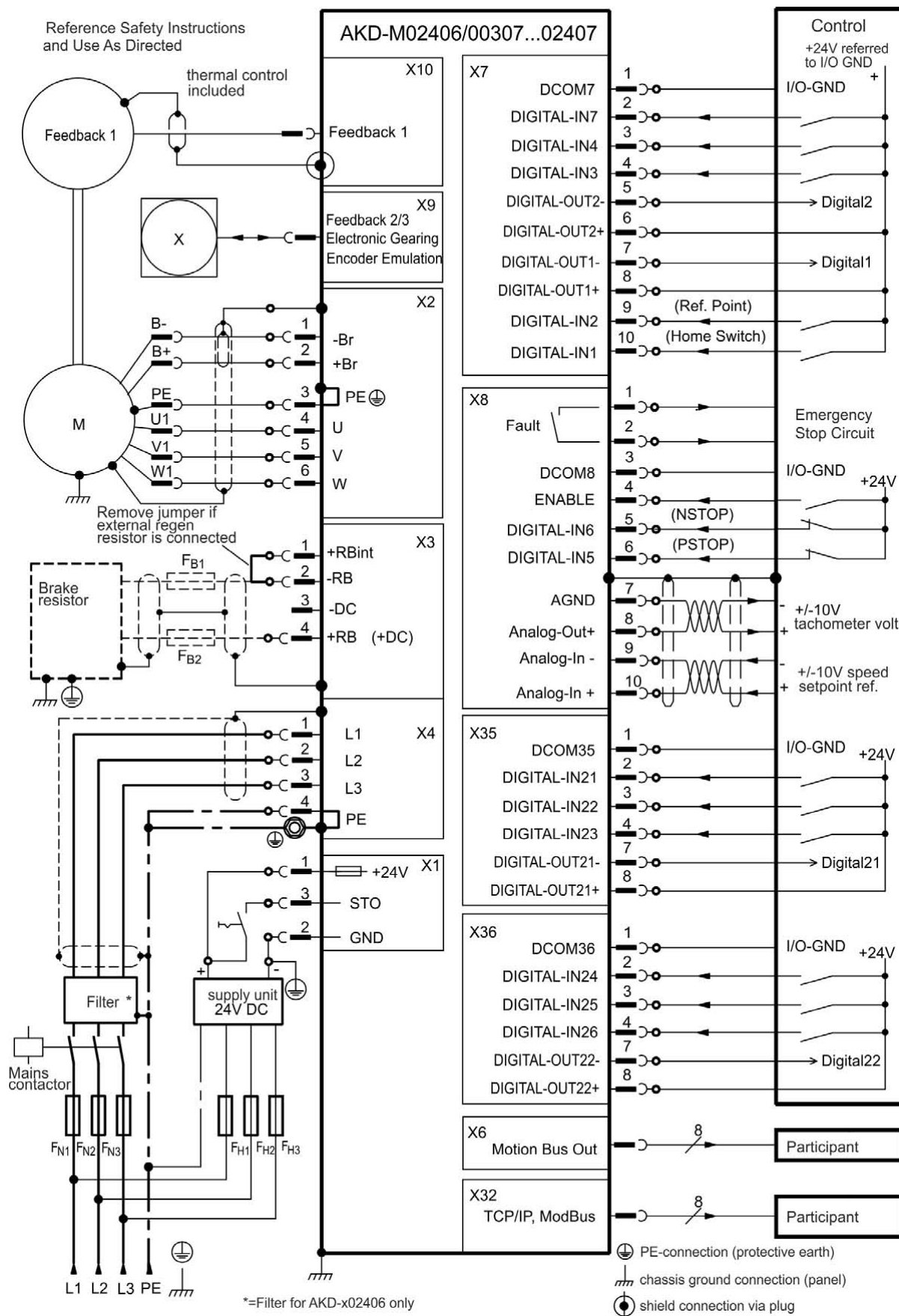

17.4 24 V auxiliary supply (X1)

The following diagram describes external 24 VDC power supply, electrically isolated, for example, via an isolating transformer. The required current rating depends on the use of motor brake and option card .

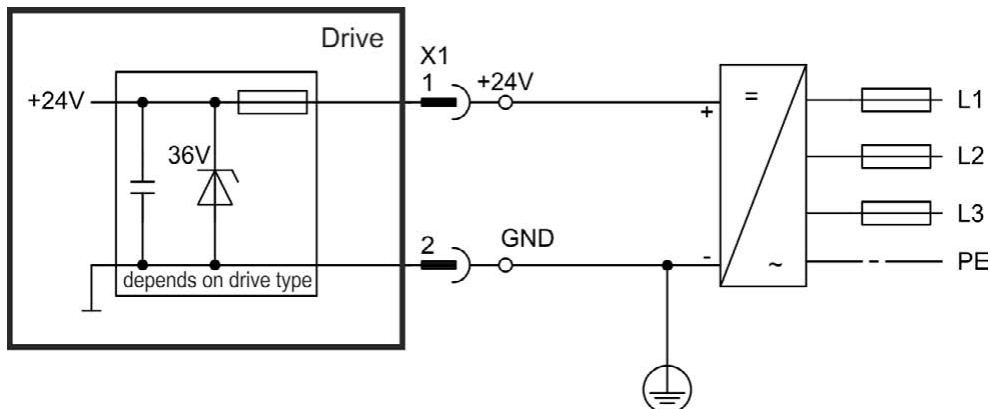

17.4.1 AKD-M003 to 024, connector X1



Pin	Signal	Description
1	+24	+24 VDC Auxiliary voltage
2	GND	24V Supply GND
3	STO	STO enable (Safe Torque Off)

17.4.2 AKD-M048, connector X1



Pin	Signal	Description
1	+24 V	+24 VDC Auxiliary voltage
2	GND	24V Supply GND
3	STO +24V	STO+24 VDC Auxiliary voltage
4	STO GND	STO Supply GND
5	STO-Status 1	Safe Torque Off status channel 1
6	STO-Enable 1	Safe Torque Off enable channel 1
7	STO-Status 2	Safe Torque Off status channel 2
8	STO-Enable 2	Safe Torque Off enable channel 2

17.5 Motor Power Connection (X2)

Together with the motor supply cable and motor winding, the power output of the drive forms an oscillating circuit. Characteristics such as cable capacity, cable length, motor inductance, and frequency determine the maximum voltage in the system.

The AKD PDMM drive is able to protect the connected motor from overloading, if the parameters are set correctly and the thermal protection sensor is connected and supervised. With Kollmorgen motors the valid data are automatically set by the internal motor database. With motors from other manufacturers the data from the nameplate must be entered to the referring fields in the motor view of the Kollmorgen setup software EWV¹.

NOTICE

The dynamic voltage rise can lead to a reduction in the motor operating life and, on unsuitable motors, to flashovers in the motor winding.

- Only install motors with insulation class F (acc. to IEC60085) or above.
- Only install cables that meet the requirements .

NOTICE

With long motor cables leakage currents endanger the output stage of the drive. For cable lengths from 25 m to 50 m, a motor choke (3YL) must be wired into the motor cable (near the drive). Refer to your regional Accessories Manual for Kollmorgen chokes.

Cable length ≤ 25 m

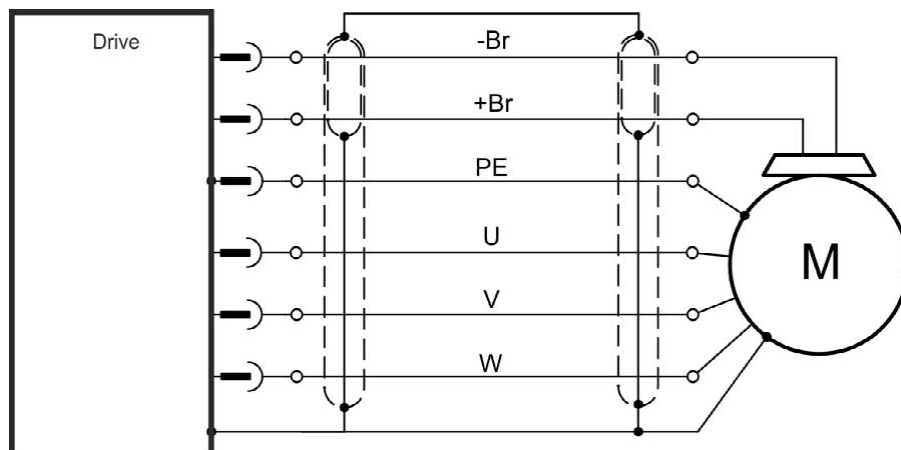

Cable length >25 m

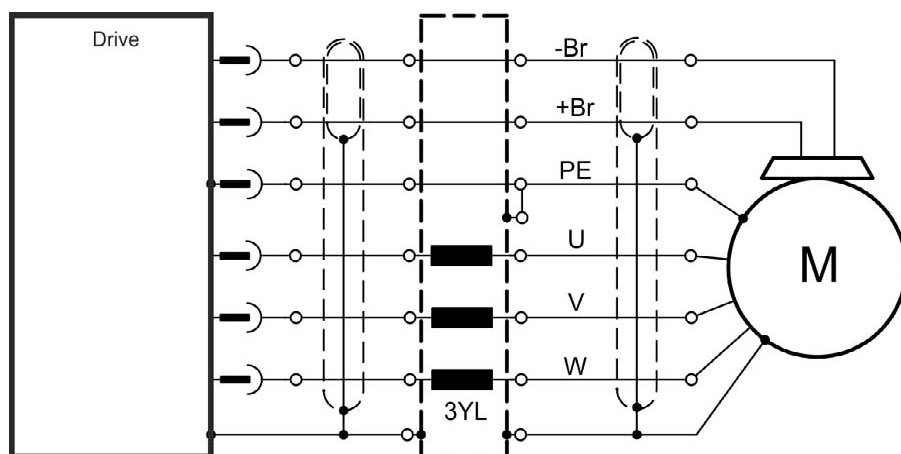

¹Embedded Workbench Views

17.5.1 AKD-M003 to 024, power connector X2

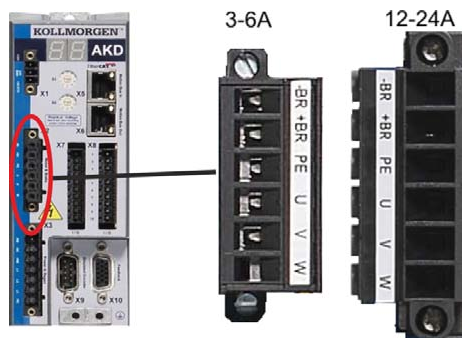

Pin	Signal	Description
1	-BR	Motor holding brake (→ p. 1)
2	+BR	Motor holding brake (→ p. 1)
3	PE	Protective earth (motor housing)
4	U	Motor phase U
5	V	Motor phase V
6	W	Motor phase W

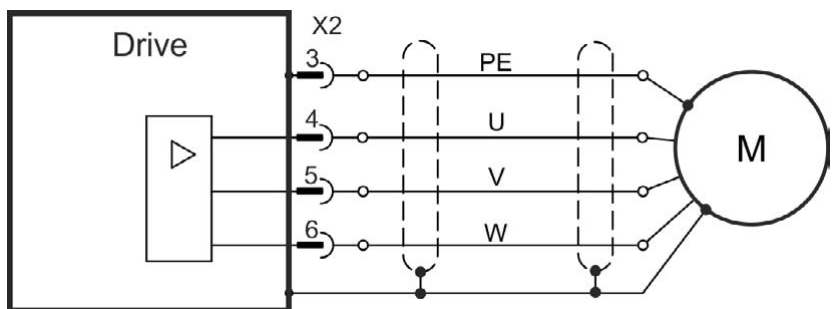

17.5.2 AKD-M048, power connector X2

NOTE
Cable length maximum 25 m.

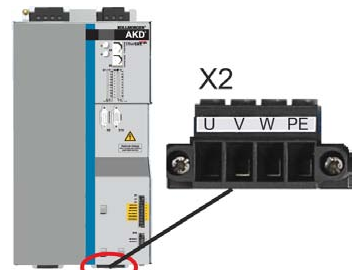

Pin	Signal	Description
1	U	Motor phase U
2	V	Motor phase V
3	W	Motor phase W
4	PE	Protective earth (motor housing)

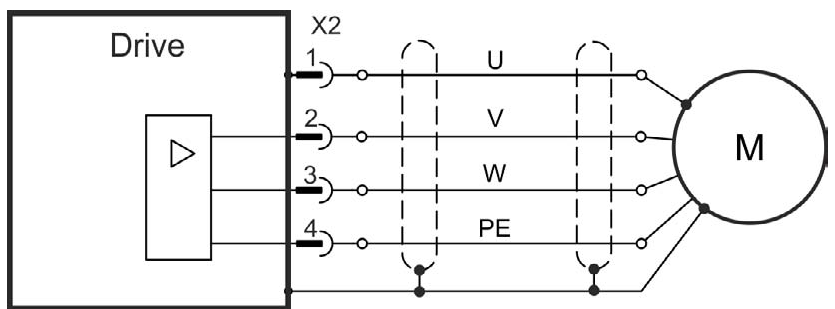

17.6 External regen resistor (X3)

For technical data on the brake circuit .

17.6.1 AKD-M003 to 024, regen connector X3

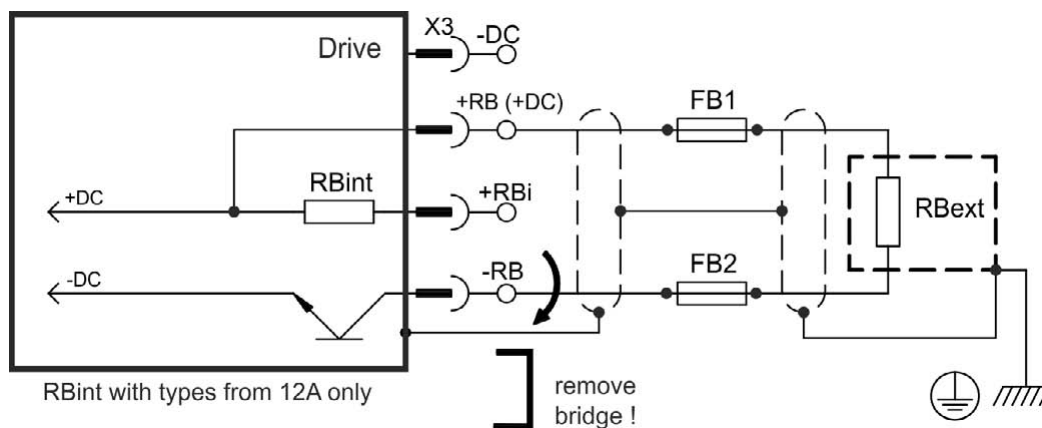

FB1 / FB2 fusing

Drive Model	Ampere rating@230V	Ampere rating@480V	UL region example:	CE Region example (Siba):
AKD-M003 to 012	10A	40A	Bussmann FWP-xxA14F	110V to 400V: gRL (gS) 400V to 480V: aR
AKD-M024	15A	50A		



Pin	Signal	Description
1	-RB	External Regen Resistor negative
3	+RB	External Regen Resistor positive

Pin	Signal	Description
1	+Rbint	Internal Regen Resistor positive
2	-RB	External Regen Resistor negative
4	+RB	External Regen Resistor positive



AKD-M02406 & AKD-M-00307 to 02407 (X3)		
Pin	Signal	Description
2	-RB	External Regen Resistor negative
4	+RB	External Regen Resistor positive

17.6.2 AKD-M048, regen connector X3

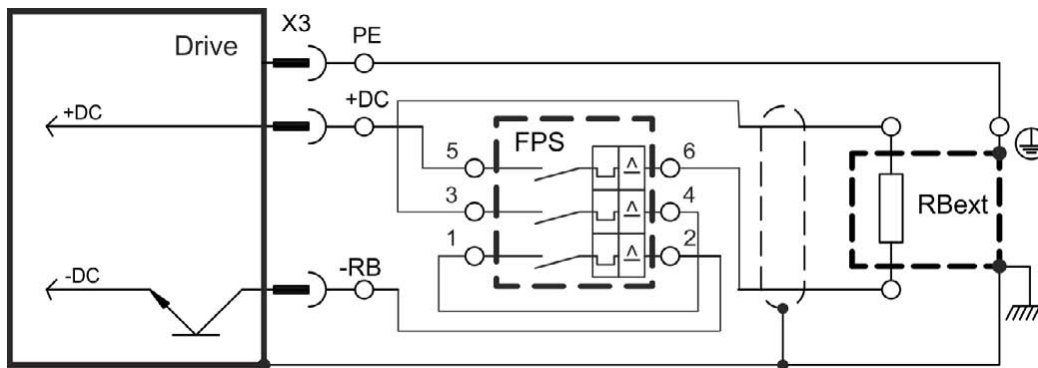

FPS: Fritzlen DC Powerswitch

RBext	FPS	Range [In]	cable cross section
BAS(U)2000-10	FPS-16	10 to 16 A	min. 2.5 mm ²
BAS(U)3000-10	FPS-20	16 to 20 A	min. 4 mm ²
BAS(U)6000-10	FPS-25	20 to 25 A	min. 4 mm ²

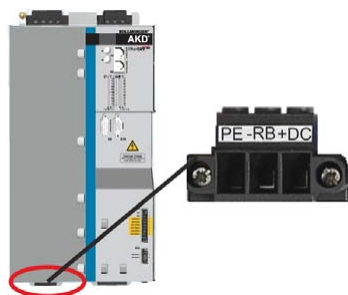

AKD-M04807		
Pin	Signal	Description
1	PE	Protective Earth
2	-RB	External Regen Resistor negative
3	+DC	External Regen Resistor positive

17.7 DC Bus link (X3, X14)

The DC bus link can be connected in parallel so that the regen power is divided between all the drives that are connected to the same DC bus link circuit. Every drive must have its own power connection to mains voltage, even if the DC bus link is used. Drives working regeneratively very often should be placed beside drives, which need energy. That reduces current flow on longer distances.

- The sum of the rated currents for all of the drives connected in parallel to an **AKD-M003 to 024** must not exceed 48 A. Use 6 mm², unshielded single cores with a max. length of 200 mm; use 6 mm² shielded cables for longer lengths. In this case no fuse for line protection is required.
- The sum of the rated currents for all of the **AKD-M048** connected in parallel to an AKD-M048 must not exceed 96 A. AKD-M048 should be connected in parallel only with AKD-M048 drives. Use 16 mm², unshielded single cores with a max. length of 30 mm; use 16 mm² shielded cables for longer lengths.

NOTICE

The drives can be destroyed, if DC bus link voltages are different. Only drives with mains supply from the same mains (identical mains supply voltage) may be connected by the DC bus link. DC bus link connection of AKD-M048 to other drives than AKD-M048 is not allowed.

NOTICE

The phase lost/ main control is not working on DC-Bus connected drives. A phase lost on a drive inside a DC Bus connection will be not detected. External phase monitoring to prevent overload of the rectifier is recommended.

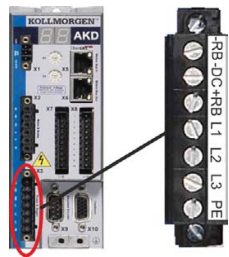

AKD-M00306 to AKD-M00606 (X3)		
Pin	Signal	Description
2	-DC	DC-Link Bus negative
3	+DC (+RB)	DC-Link Bus positive

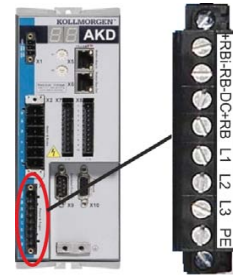

AKD-M01206 (X3)		
Pin	Signal	Description
3	-DC	DC-Link Bus negative
4	+DC (+RB)	DC-Link Bus positive



AKD-M02406 & AKD PDMM00307 to AKD PDMM02407 (X3)		
Pin	Signal	Description
3	-DC	DC-Link Bus negative
4	+DC (+RB)	DC-Link Bus positive

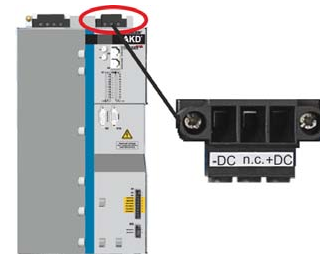

AKD-M04807 (X14)		
Pin	Signal	Description
1	-DC	DC-Link Bus negative
2	n.c.	not connected
3	+DC	DC-Link Bus positive

NOTE: Should be connected in parallel only with AKD-M048 drives.

17.7.1 DC Bus topology with Y connectors (24 A max.)

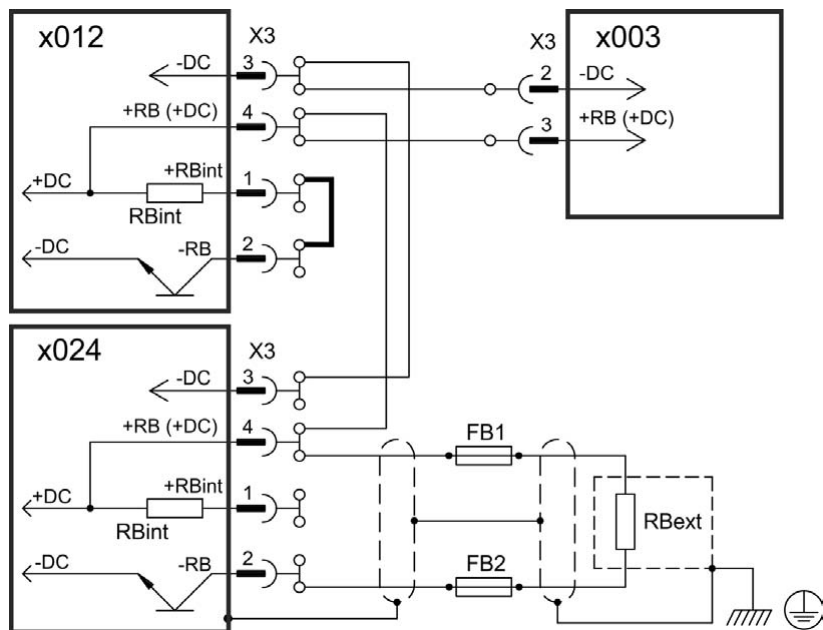

Without DC Bus fuses, other devices can become damaged or destroyed if, for example, a device fails due to an internal short circuit. If multiple drives are connected in parallel, then it is usual to insert DC Bus fuses () between groups of drives (with a group consisting of two or three devices, depending on the current) in order to limit any possible resulting damage. Fuses cannot avoid damage by current peaks completely.

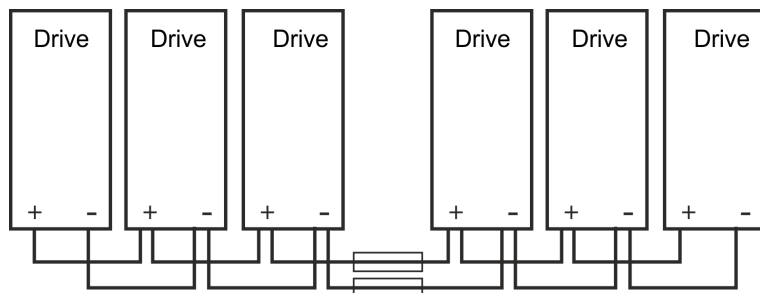

17.7.2 DC Bus topology with busbar

This wiring does not require Y connectors. If a device fails due to a short-circuit, only its DC Bus fuses () are tripped and the rest of the network continues uninterrupted. The solid busbars can conduct significantly larger currents, because the compensating current does not flow through the connector as above. For this reason, almost as many drives as desired can be connected in parallel in this form. This arrangement is frequently also useful for connecting KCM capacitor modules.

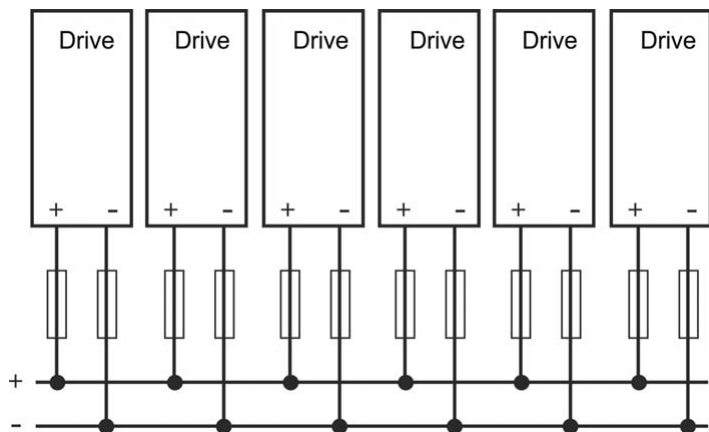

17.8 Mains supply connection (X3, X4)

Drives in the AKD PDMM series can be supplied as follows:

- AKD-Mzzz06: 1 or 3 phase industrial supply networks (not more than 200 kA symmetrical rated current at 120 V and 240 V).
- AKD-Mzzz07: 3 phase industrial supply networks (not more than 200 kA symmetrical rated current at 240 V, 400 V and 480 V).

Connection to other voltage types of supply networks is possible with an additional isolating transformer (→ p. 1). Periodic overvoltages between phases (L1, L2, L3) and the housing of the drive must not exceed 1000 V peak. In accordance with IEC 61800, voltage spikes (< 50 µs) between phases must not exceed 1000 V. Voltage spikes (< 50 µs) between a phase and the housing must not exceed 2000 V.

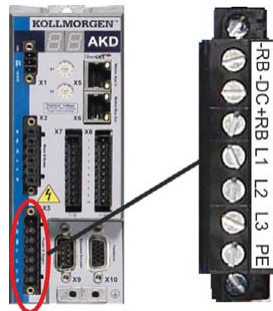

AKD-M00306 to AKD-M00606 (X3)		
Pin	Signal	Description
4	L1	Line 1
5	L2	Line 2
6	L3	Line 3
7	PE	Protective Earth

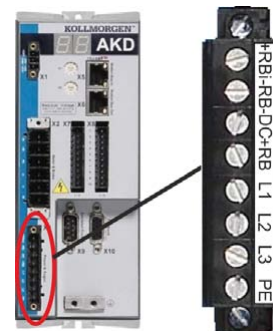

AKD-M01206 (X3)		
Pin	Signal	Description
5	L1	Line 1
6	L2	Line 2
7	L3	Line 3
8	PE	Protective Earth



AKD-M02406 & AKD-M00307 to AKD-M02407 (X4)		
Pin	Signal	Description
1	L1	Line 3
2	L2	Line 2
3	L3	Line 1
4	PE	Protective Earth

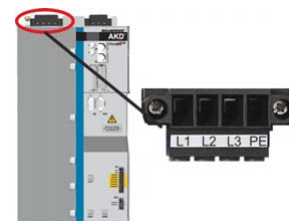

AKD-M04807 (X4)		
Pin	Signal	Description
1	L1	Line 1
2	L2	Line 2
3	L3	Line 3
4	PE	Protective Earth

17.8.1 Three phase connection (all AKD PDMM types)

- Directly to 3-phase supply network, supply networks
- Filtering for AKD-Mzzz06 to be provided by the user.
- Fusing (such as fusible cut-outs) to be provided by the user .

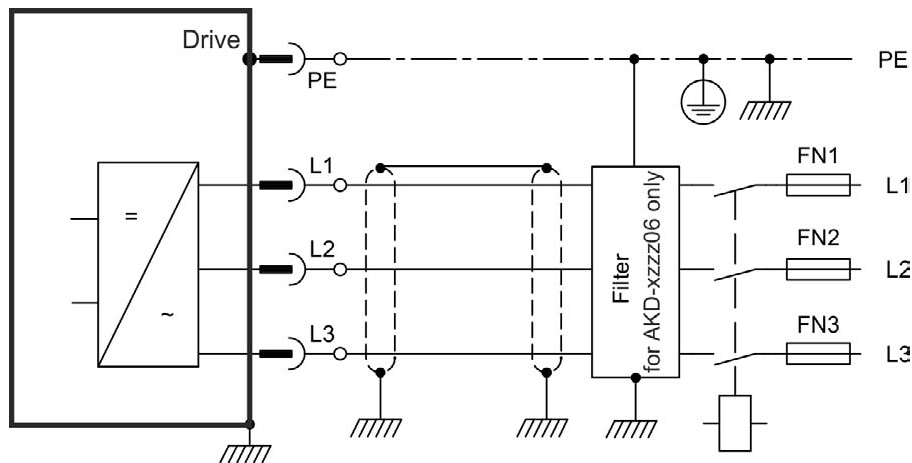

17.8.2 Single/Dual phase connection (AKD-M00306 to AKD-M01206 only)

- Directly to single-phase supply network ($120\text{ V}_{-10\%}$ to $240\text{ V}^{+10\%}$) with neutral line or
Directly to two-phase supply network ($120\text{ V}_{-10\%}$ to $240\text{ V}^{+10\%}$) without neutral line
- Supply networks
- Leave L3 open circuit
- Filtering to be provided by the user.
- Fusing (such as fusible cut-outs) to be provided by the user

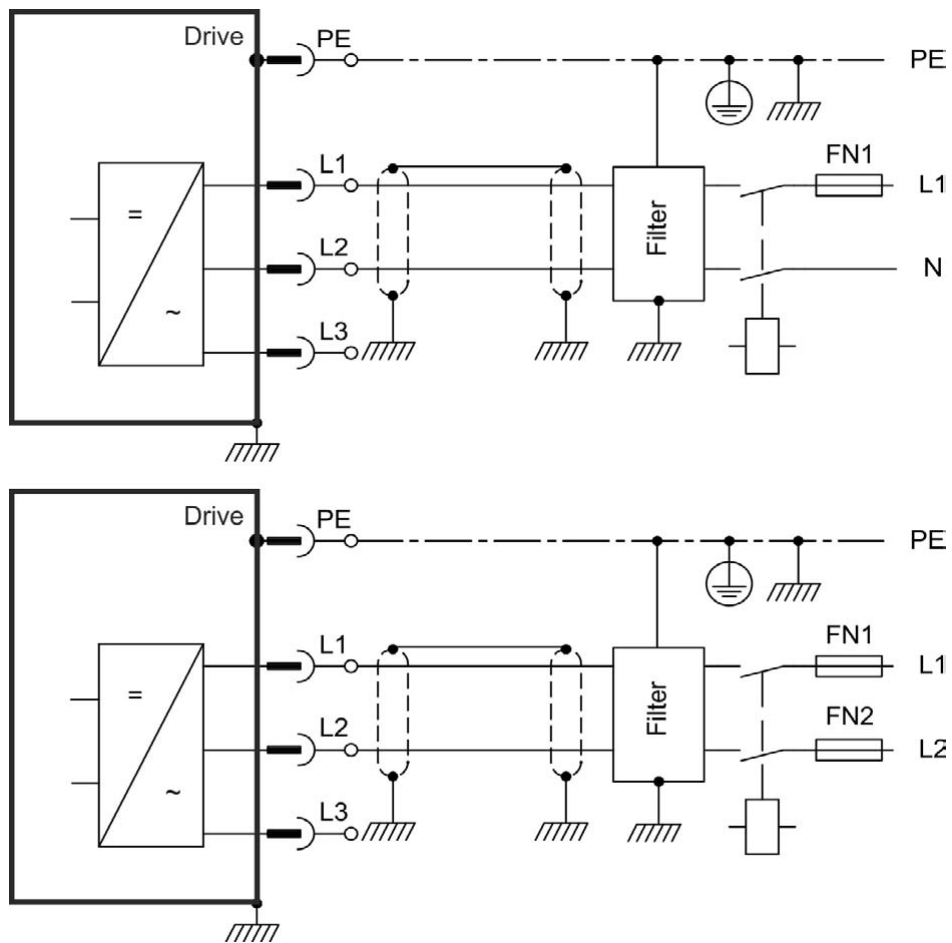

17.9 I/O Connection

17.9.1 Overview

17.9.1.1 I/O connectors X7 and X8 (all AKD PDMM variants)

Standard digital and analog I/O signals are connected to X7 and X8.

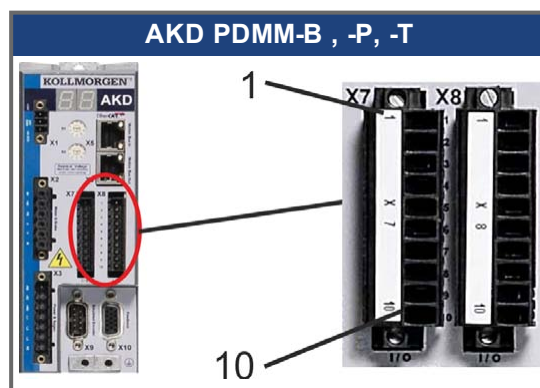

Conn.	Pin	Signal	Abbreviation	Function
X7	1	Digital Common X7	DCOM7	Common line for X7 pins 2, 3, 4, 9, 10
X7	2	Digital Input 7	DIGITAL-IN 7	Programmable
X7	3	Digital Input 4	DIGITAL-IN 4	Programmable
X7	4	Digital Input 3	DIGITAL-IN 3	Programmable
X7	5	Digital Output 2-	DIGITAL-OUT2-	Programmable
X7	6	Digital Output 2+	DIGITAL-OUT2+	Programmable
X7	7	Digital Output 1-	DIGITAL-OUT1-	Programmable
X7	8	Digital Output 1+	DIGITAL-OUT1+	Programmable
X7	9	Digital Input 2	DIGITAL-IN 2	Programmable,fast
X7	10	Digital Input 1	DIGITAL-IN 1	Programmable,fast
X8	1	Fault Relay Output	Fault Relay Out-put	Fault Relay Output
X8	2	Fault Relay Output	Fault Relay Out-put	Fault Relay Output
X8	3	Digital Common X8	DCOM8	Common line for X8 pins 4, 5, 6
X8	4	Digital Input 8	DIGITAL-IN 8	Output stage enable, not programmable
X8	5	Digital Input 6	DIGITAL-IN 6	Programmable
X8	6	Digital Input 5	DIGITAL-IN 5	Programmable
X8	7	Analog Ground	AGND	Analog GND
X8	8	Analog Output +	Analog-Out	Actual velocity voltage
X8	9	Analog Input -	Analog-In-	Velocity set point
X8	10	Analog Input +	Analog-In+	

Digital common lines for X7 and X8 are not common to each other.

The DCOMx line should be connected to the 0V of the I/O supply when using sensors of type "Source" with digital inputs.

The DCOMx line should be connected to the 24V of the I/O supply when using sensors of type "Sink" with digital inputs.

17.9.1.2 I/O connectors X35 and X36 (AKD PDMM only)

AKD PDMM offers two additional connectors X35 and X36 for digital I/O signals.

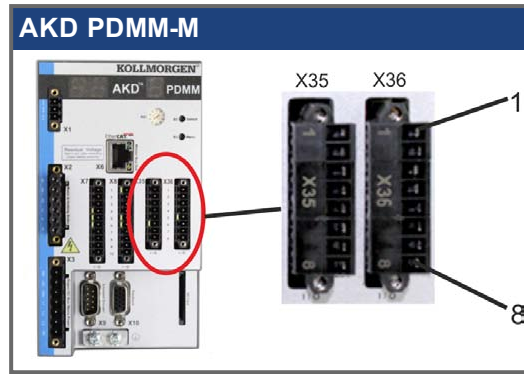

Conn.	Pin	Signal	Abbreviation	Function
X35	1	Digital Common X35	DCOM35	Common line for X35 pins 2, 3, 4
X35	2	Digital Input 21	DIGITAL-IN 21	Programmable
X35	3	Digital Input 22	DIGITAL-IN 22	Programmable
X35	4	Digital Input 23	DIGITAL-IN 23	Programmable
X35	5	n.c.	n.c.	-
X35	6	n.c.	n.c.	-
X35	7	Digital Output 21-	DIGITAL-OUT21-	Programmable
X35	8	Digital Output 21+	DIGITAL-OUT21+	Programmable
X36	1	Digital Common X36	DCOM36	Common line for X36 pins 2, 3, 4
X36	2	Digital Input 24	DIGITAL-IN 24	Programmable
X36	3	Digital Input 25	DIGITAL-IN 25	Programmable
X36	4	Digital Input 26	DIGITAL-IN 26	Programmable
X36	5	n.c.	n.c.	-
X36	6	n.c.	n.c.	-
X36	7	Digital Output 22-	DIGITAL-OUT22-	Programmable
X36	8	Digital Output 22+	DIGITAL-OUT22+	Programmable

Digital common lines for X35 and X36 are not common to each other.
 The DCOMx line should be connected to the 0V of the I/O supply when using sensors of type "Source" with digital inputs.
 The DCOMx line should be connected to the 24V of the I/O supply when using sensors of type "Sink" with digital inputs.

17.10 Analog Output (X8)

Analog Outputs can be used to output converted analog values of digital measurements recorded in the drive. The standard drive offers one analog output on X8. A list of the pre-programmed functions is included in the EWV¹ setup software.

Technical characteristics

¹Embedded Workbench Views

- Output voltage range referring to AGND: ± 10 V
- Resolution: 16 Bit and fully monotonic
- Update rate: 4 kHz
- Unadjusted offset: < 50 mV
- Offset drift typ: $250 \mu\text{V}/^\circ\text{C}$
- Gain or slope tolerance: $\pm 3\%$
- Nonlinearity: $< 0.1\%$ of full scale or 10 mV
- Output impedance: 110 ohms
- Specification complies with IEC 61131-2 Table 11
- -3 dB Bandwidth: > 8 kHz
- Maximum output current: 20 mA
- Capacitive load: any value but response speed limited by max Iout and by Rout
- Protected for short circuit to AGND

Analog Output Wiring Diagram

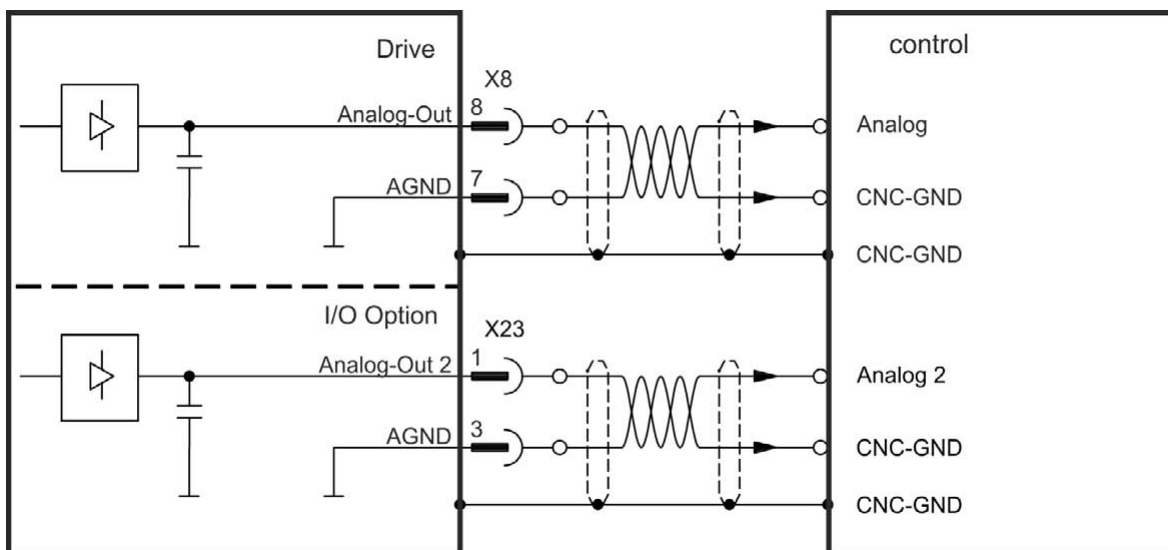

17.11 Analog Input (X8)

The drive is fitted with differential inputs for analog torque, velocity, or position control. The standard drive offers one analog input on X8.

Technical characteristics

- Differential input voltage range: ± 12.5 V
- Maximum input voltage referring to I/O Return: -12.5, +16.0 V
- Resolution: 16 Bit and fully monotonic
- Firmware update rate: 16 kHz
- Unadjusted offset: < 50 mV
- Offset drift typ: $250 \mu\text{V} / ^\circ\text{C}$
- Gain or slope tolerance: $\pm 3\%$
- Nonlinearity: $< 0.1\%$ of full scale or 12.5 mV
- Common Mode Rejection Ratio: > 30 dB at 60 Hz
- Input impedance: $> 13\text{k}$ Ohms
- Signal to noise ratio referred to full scale:
 - AIN.CUTOFF = 3000 Hz: 14 bit
 - AIN.CUTOFF = 800 Hz: 16 bit

Analog Input Wiring Diagram

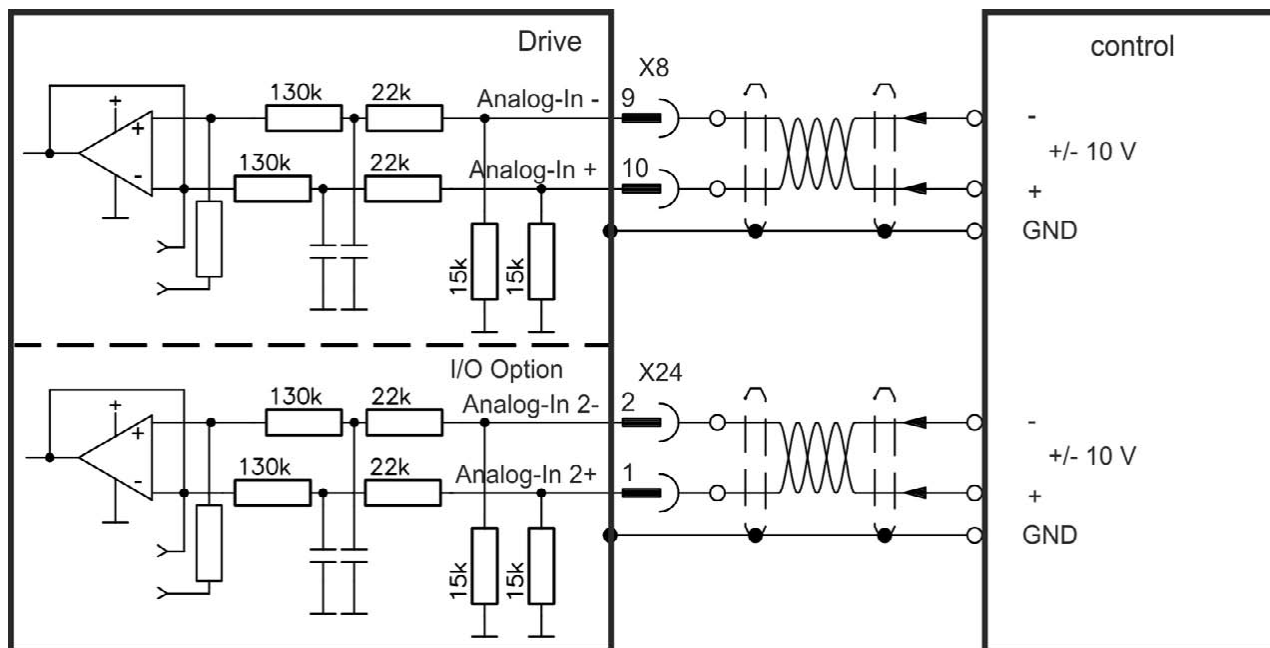

Application examples for set point input Analog-In:

- reduced-sensitivity input for setting-up/jog operation
- pre-control/override

Defining the direction of rotation

Standard setting: clockwise rotation of the motor shaft (looking at the shaft end) affected by positive voltage between terminal (+) and terminal (-)

To reverse the direction of rotation, swap the connections to terminals +/-, or change the DRV.DIR parameter in the “Feedback 1” screen page.

17.12 Command encoder signal connection

17.12.1 Incremental encoder input 5 V (X9)

A 5 V A quad B encoder, or the encoder emulation output of another drive can be connected to this input and used as a commander encoder, dual loop feedback, gearing or camming input. Don't use for primary motor feedback connection!

Connection Diagram

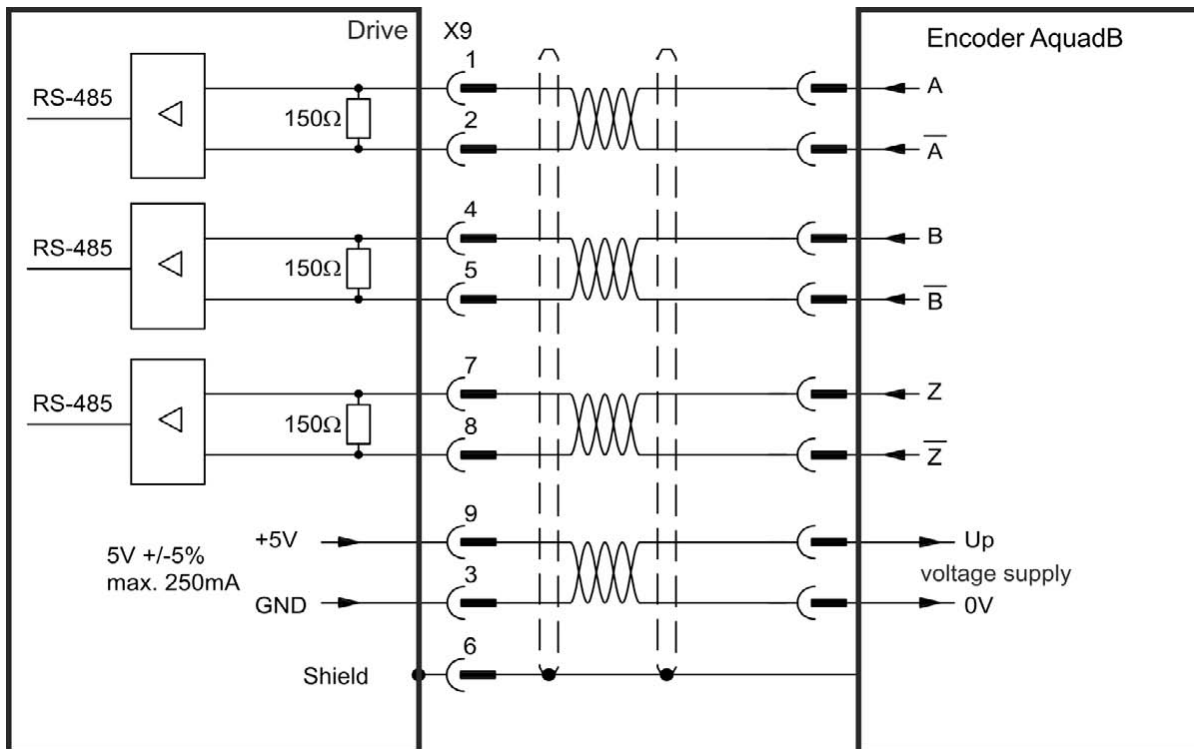

17.12.2 Incremental encoder input 24 V (X7)

A 24 V A quad B encoder can be connected to the digital inputs 1 and 2 and used as a commander encoder, dual loop feedback, gearing or camming input. Don't use for primary motor feedback connection!

Connection Diagram

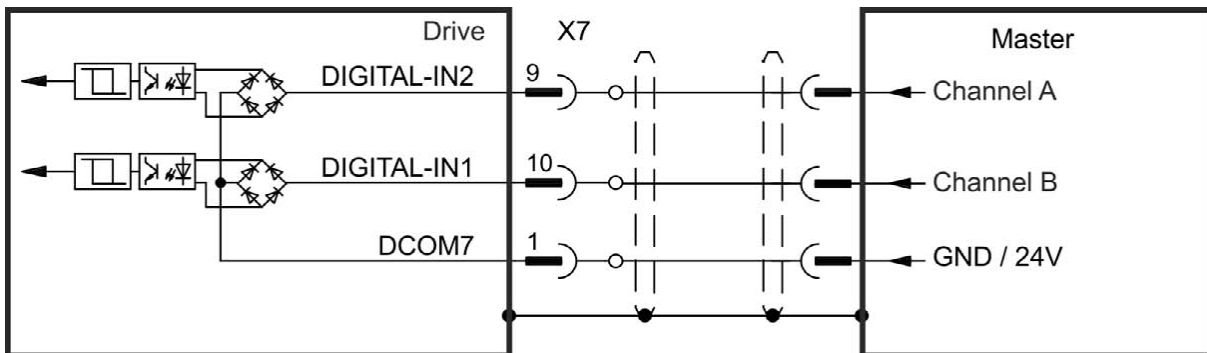

17.12.3 Encoder with EnDat 2.2 input 5 V (X9)

A single-turn or multi-turn encoder with EnDat 2.2 can be connected to this input and used as a commander encoder, dual loop feedback, gearing or camming input, or as primary motor feedback connection.

Connection Diagram

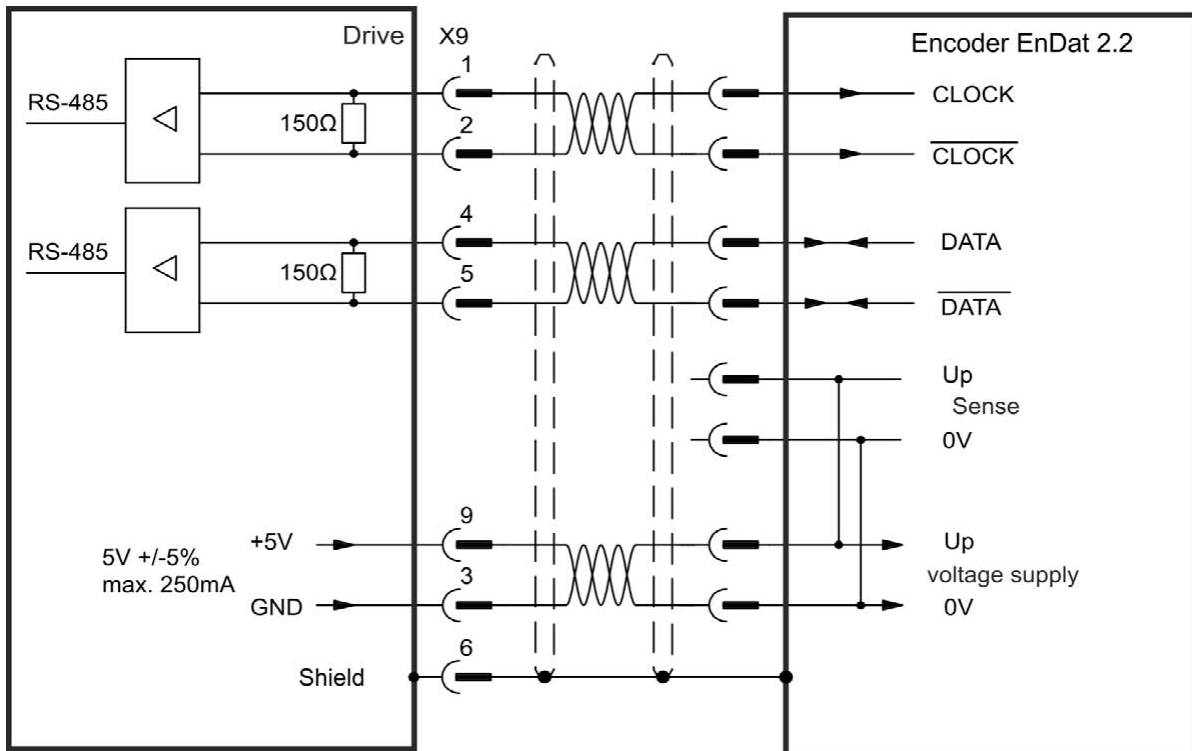

17.13 Pulse / Direction signal connection

The drive can be connected to a stepper-motor controller. Set parameters for the drive with EWW¹. The number of pulses can be adjusted, so that the drive can be adapted to match any stepper controller.

Speed profile and signal diagram

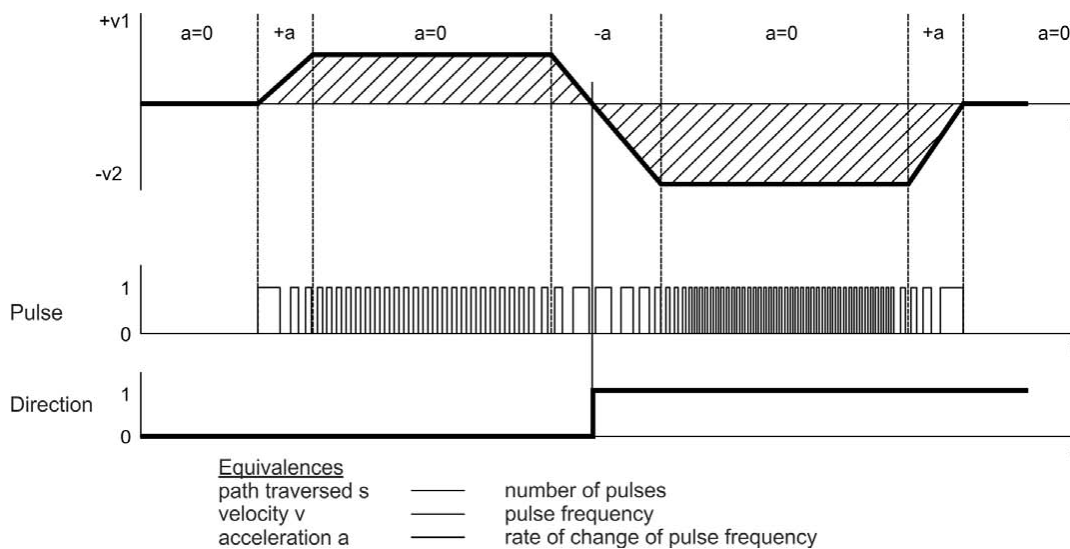

¹Embedded Workbench Views

17.13.1 Pulse / Direction input 5 V (X9)

Connection to 5 V signal level stepper-motor controllers.

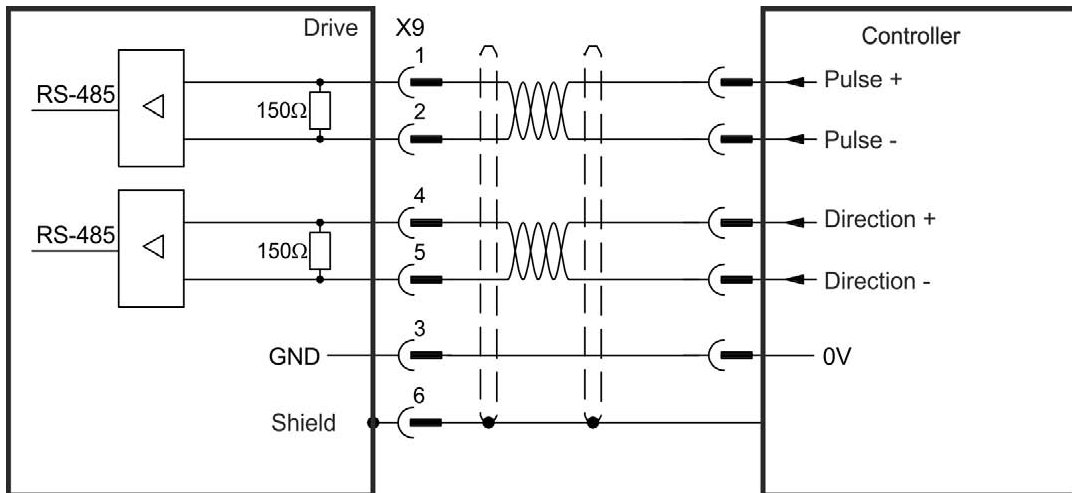

17.13.2 Pulse / Direction Input 5 V to 24 V (X7)

Connection industry standard 5V logic stepper-motor controllers with Pulse/Direction or Step/Direction outputs. Note that the X7 opto inputs can work with 5V up to 24V logic and so these inputs can be driven by 24V logic inputs as well.

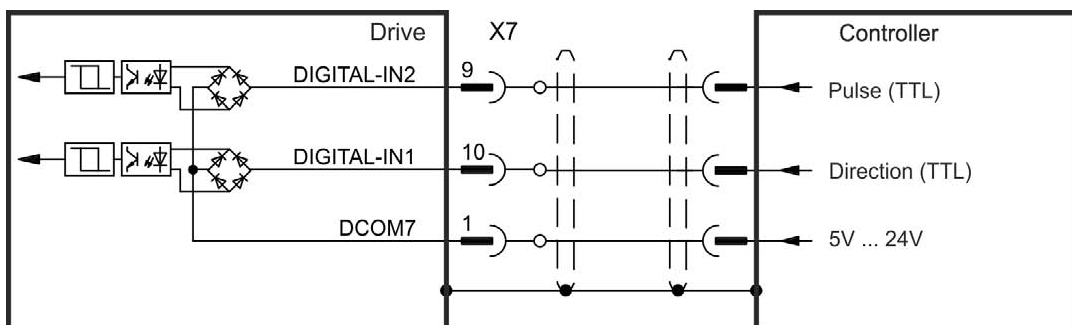

17.14 CW / CCW signal connection

17.14.1 CW / CCW input 5 V (X9)

The drive can be connected to a third-party controller which delivers 5 V CW/CCW signals

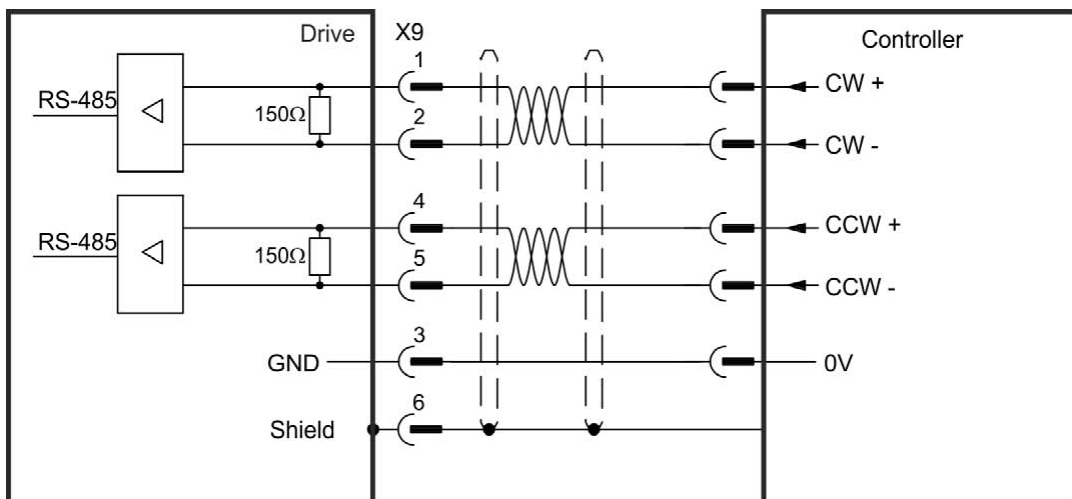

17.14.2 CW / CCW input 24 V (X7)

The drive can be connected to a third-party controller which delivers 24 V CW/CCW signals.

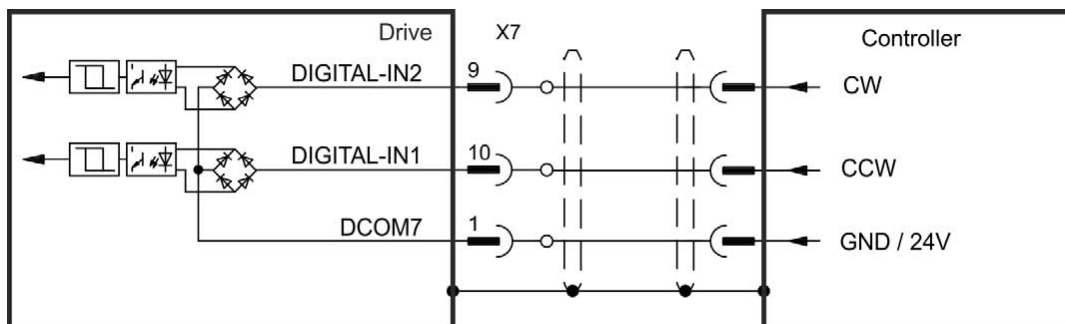

17.15 Feedback connector (X10)

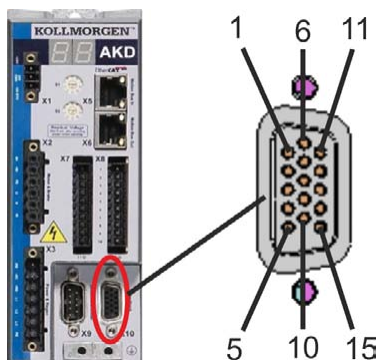

PIN	SFD	SFD3/DSL	Resolver	BiSS B (analog)	BiSS C (digital)	EnDAT 2.1	EnDAT 2.2	Hiper-face	Sine Enc. +Hall	Tamagawa Smart Abs*	Incr. Enc. +Hall
1	-	-	-	-	-	-	-	-	Hall U	-	Hall U

PIN	SFD	SFD3/DSL	Resolver	BiSS B (analog)	BiSS C (digital)	EnDAT 2.1	EnDAT 2.2	Hiper-face	Sine Enc. +Hall	Tamagawa Smart Abs*	Incr. Enc. +Hall
2	-	-	-	CLK+	CLK+	CLK+	CLK+	-	Hall V	-	Hall V
3	-	-	-	CLK-	CLK-	CLK-	CLK-	-	Hall W	-	Hall W
4	SEN+	-	-	SEN+	SEN+	SEN+	SEN+	SEN+	SEN+	SEN+	SEN+
5	SEN-	-	-	SEN-	SEN-	SEN-	SEN-	SEN-	SEN-	SEN-	SEN-
6	COM+	COM+	R1 Ref+	DAT+	DAT+	DAT+	DAT+	DAT+	Zero+	SD+	Zero+
7	COM-	COM-	R2 Ref-	DAT-	DAT-	DAT-	DAT-	DAT-	Zero-	SD-	Zero-
8	-	-	Thermal control (+)								
9	-	-	Thermal control (-)								
10	+5 V	+5 V	-	+5 V	+5 V	+5 V	+5 V	+8 to +9 V	+5 V	+5 V	+5 V
11	0 V	0 V	-	0 V	0 V	0 V	0 V	0 V	0 V	0 V	0 V
12	-	-	S1 SIN+	A+	-	A+	-	SIN+	A+	-	A+
13	-	-	S3 SIN-	A-	-	A-	-	SIN-	A-	-	A-
14	-	-	S2 COS+	B+	-	B+	-	COS+	B+	-	B+
15	-	-	S4 COS-	B-	-	B-	-	COS-	B-	-	B-

CLK = CLOCK, DAT = DATA, SEN = SENSE, *= for AKD PDMM with "NB" (rev 8+) only

17.16 Feedback connector (X9)

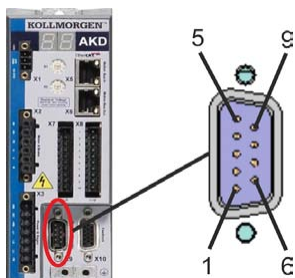

Pin	Pulse/Direction	CW/CCW	Incremental Encoder	Encoder with EnDat 2.2
1	Pulse+	CW+	A+	CLOCK+
2	Pulse-	CW-	A-	CLOCK-
3	GND	GND	GND	GND
4	Direction+	CCW+	B+	DATA+
5	Direction-	CCW-	B-	DATA-
6	Shield	Shield	Shield	Shield
7	-	-	Zero+	-
8	-	-	Zero-	-
9	-	-	+ 5 V (supply, output)	+5V (supply, output)

17.17 Feedback connector (X7)

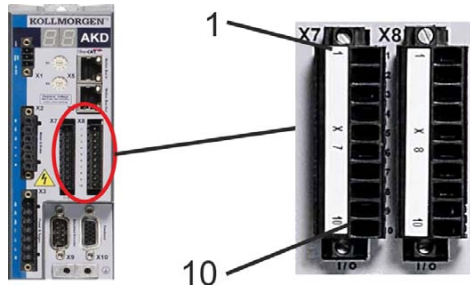

Pin	Pulse/Direction	CW/CCW	Incremental Encoder
9	Pulse	CW	Channel A
10	Direction	CCW	Channel B
1	Common	Common	Common

18 AKD PDMM Firmware

18.1 Check AKD PDMM Drive Firmware

To check AKD PDMM Firmware with KAS IDE:

1. Create a new project
2. Set the controller type and IP address
3. In the Project Explorer, double-click the **EtherCAT** node to open the EtherCAT Devices summary window
4. In the Devices tab, click the **Scan Devices** button
5. Choose the **Create...** option to map the physical device to a new device
6. If the version is not correct, continue following with the procedure below
7. Compile the project
8. Connect to the controller
9. Download the project to the controller
10. If the version is not correct, download the new firmware ([click here](#)) and follow with the next procedure.

18.2 Download AKD PDMM Drive Firmware

Component	Download
AKD PDMM Drive FW - Version: AKD-M-MCEC-V01-06-00-003.i00	4 MB

To upgrade AKD PDMM Firmware with KAS IDE, continue from the previous procedure as follows:

1. In the EtherCAT Devices summary window, deactivate the **Online Configuration Mode**
2. Select the drives to be updated with the same firmware
(Note that the FW download is limited to 16 drives at a time)
3. Click **Upgrade Firmware** button

WARNING

Give careful attention to any warning dialog that appears at this point. These warnings usually include important information about preventing damage to the drives.

3. Browse to select the new AKD firmware file
4. Click **Open** to start the updating procedure

18.3 AKD PDMM Firmware Update

Based on the FoE protocol, the AKD PDMM Firmware can be downloaded as follows:

1. Scan the devices and make sure all devices are created
2. Compile the project
3. Connect to the controller
4. Download the project to the controller
5. Open the **EtherCAT Devices** summary form
6. Select the drives to be updated with the same firmware
7. Click the Upgrade Firmware button

WARNING

Give careful attention to any warning dialog that appears at this point. These warnings usually include important information about preventing damage to the drives.

8. Browse to select the new AKD firmware file

9. Click **Open** to start the updating procedure

NOTE

This procedure is not possible when applications are running and when the drive is in Online Configuration Mode.

During the firmware download, the AKD Firmware Update window displays a progress bar and the following messages are displayed:

- Uploading firmware to the drive
During the download process, the drive LED displays [dL]. Additional codes may appear during the download; see 3.2 Display Codes for a description of codes related to the firmware download.
- Resetting the drive
- Firmware update is complete

⚠ CAUTION

While the firmware is downloading to your drive, do not remove the 24V logic power. If you remove the 24V logic power during a firmware download, a severe drive crash can occur. If a crash occurs, the drive will restart in a special mode and prompt you to reload the firmware.

19 Parameter and Command Reference Guide

19.1 About the Parameter and Command Reference Guide	242
19.1.1 Parameter and Command Naming Conventions	243
19.1.2 Summary of Parameters and Commands	244
19.2 AOUT Parameters	260
19.2.1 AOUT.CUTOFF	261
19.2.2 AOUT.DEBUGADDR	262
19.2.3 AOUT.DEBUGDATATYPE	263
19.2.4 AOUT.DEBUGSCALE	264
19.2.5 AOUT.ISCALE	265
19.2.6 AOUT.MODE	266
19.2.7 AOUT.OFFSET	267
19.2.8 AOUT.PSCALE	268
19.2.9 AOUT.VALUE	269
19.2.10 AOUT.VALUEU	270
19.2.11 AOUT.VSCALE	271
19.3 AOUT2 Parameters	272
19.3.1 AOUT2.CUTOFF	273
19.3.2 AOUT2.MODE	274
19.3.3 AOUT2.OFFSET	275
19.3.4 AOUT2.VALUE	276
19.3.5 AOUT2.VALUEU	277
19.4 BODE Parameters	278
19.4.1 BODE.EXCITEGAP	279
19.4.2 BODE.FREQ	280
19.4.3 BODE.IAMP	281
19.4.4 BODE.IFLIMIT	282
19.4.5 BODE.IFTHRESH	283
19.4.6 BODE.INJECTPOINT	284
19.4.7 BODE.MODE	285
19.4.8 BODE.MODETIMER	288
19.4.9 BODE.PRBDEPTH	290
19.4.10 BODE.VAMP	291

19.4.11 BODE.VFLIMIT	292
19.4.12 BODE.VFTHRESH	293
19.5 CMP Parameters	294
19.5.1 CMPx.ADVANCE	295
19.5.2 CMPx.ARM	296
19.5.3 CMPx.MODBOUND1	297
19.5.4 CMPx.MODBOUND2	298
19.5.5 CMPx.MODE	299
19.5.6 CMPx.MODEN	301
19.5.7 CMPx.MODVALUE	302
19.5.8 CMPx.OUTMASK	303
19.5.9 CMPx.SETPOINT	304
19.5.10 CMPx.SOURCE	306
19.5.11 CMPx.SOURCEVALUE	307
19.5.12 CMPx.STATE	308
19.5.13 CMPx.WIDTH	309
19.5.14 CMPx.WIDTHTYPE	311
19.6 CS Parameters	313
19.6.1 CS.DEC	314
19.6.2 CS.STATE	315
19.6.3 CS.TO	316
19.6.4 CS.VTHRESH	317
19.7 DIN Parameters	318
19.7.1 DIN.HCMD1 TO DIN.HCMD4	319
19.7.2 DIN.LCMD1 to DIN.LCMD4	320
19.7.3 DIN.ROTARY	321
19.7.4 DIN.STATES	322
19.7.5 DIN1.FILTER TO DIN7.FILTER	323
19.7.6 DIN1.INV to DIN7.INV	324
19.7.7 DIN1.MODE TO DIN7.MODE	325
19.7.8 DIN1.PARAM TO DIN7.PARAM	327
19.7.9 DIN1.STATE TO DIN7.STATE	329
19.7.10 DIN9.STATE to DIN11.STATE	330
19.7.11 DIN21.FILTER to DIN32.FILTER	331

19.7.12 DIN21.STATE to DIN32.STATE	332
19.8 DIO Parameters	333
19.8.1 DIO9.INV to DIO11.INV	334
19.8.2 DIO9.DIR to DIO11.DIR	335
19.9 DOUT Parameters	336
19.9.1 DOUT.CTRL	337
19.9.2 DOUT.RELAYMODE	338
19.9.3 DOUT.STATES	339
19.9.4 DOUT1.MODE and DOUT2.MODE	340
19.9.5 DOUT1.PARAM AND DOUT2.PARAM	341
19.9.6 DOUT1.STATE AND DOUT2.STATE	343
19.9.7 DOUT1.STATEU AND DOUT2.STATEU	344
19.9.8 DOUT9.MODE to DOUT11.MODE	345
19.9.9 DOUT9.PARAM to DOUT11.MODE	346
19.9.10 DOUT9.STATE to DOUT11.STATE	347
19.9.11 DOUT9.STATEU to DOUT11.STATEU	348
19.9.12 DOUT21.STATE to DOUT32.STATE	349
19.9.13 DOUT21.STATEU to DOUT32.STATEU	350
19.10 DRV Parameters	351
19.10.1 DRV.ACC	354
19.10.2 DRV.ACTIVE	356
19.10.3 DRV.BLINKDISPLAY	357
19.10.4 DRV.BOOTTIME	358
19.10.5 DRV.CLRFAULTHIST	359
19.10.6 DRV.CLRFAULTS	360
19.10.7 DRV.CMDDELAY	361
19.10.8 DRV.CMDSOURCE	362
19.10.9 DRV.CRASHDUMP	363
19.10.10 DRV.CUSTOMIDENTIFIER	364
19.10.11 DRV.DBILIMIT	365
19.10.12 DRV.DEC	366
19.10.13 DRV.DIFVAR	368
19.10.14 DRV.DIR	369
19.10.15 DRV.DIS	371

19.10.16 DRV.DISMODE	372
19.10.17 DRV.DISSOURCES	373
19.10.18 DRV.DISSOURCESMASK	374
19.10.19 DRV.DISTO	375
19.10.20 DRV.DOWNLOADALLOWED	376
19.10.21 DRV.EMUHECKSPEED	377
19.10.22 DRV.EMUEDIR	378
19.10.23 DRV.EMUEMODE	379
19.10.24 DRV.EMUEMTURN	381
19.10.25 DRV.EMUEPULSEWIDTH	382
19.10.26 DRV.EMUERES	383
19.10.27 DRV.EMUEZOFFSET	384
19.10.28 DRV.EN	385
19.10.29 DRV.ENDEFAULT	386
19.10.30 DRV.ERRORLIST	387
19.10.31 DRV.FAULTDISPLAYMODE	388
19.10.32 DRV.FAULTHIST	389
19.10.33 DRV.FAULT1 to DRV.FAULT10	390
19.10.34 DRV.FAULTS	391
19.10.35 DRV.HANDWHEELSRC	392
19.10.36 DRV.HELP	393
19.10.37 DRV.HELPALL	394
19.10.38 DRV.HWENABLE	395
19.10.39 DRV.HWENDELAY	396
19.10.40 DRV.HWENMODE	397
19.10.41 DRV.ICONT	398
19.10.42 DRV.INFO	399
19.10.43 DRV.IPEAK	401
19.10.44 DRV.IZERO	402
19.10.45 DRV.LIST	403
19.10.46 DRV.LOGICVOLTS	404
19.10.47 DRV.MEMADDR	405
19.10.48 DRV.MEMDATA	406
19.10.49 DRV.MOTIONDISSOURCES	407

19.10.50 DRV.NAME	408
19.10.51 DRV.NVCHECK	409
19.10.52 DRV.NVLIST	410
19.10.53 DRV.NVLOAD	411
19.10.54 DRV.NVSAVE	412
19.10.55 DRV.ONTIME	413
19.10.56 DRV.OPMODE	414
19.10.57 DRV.READFORMAT	415
19.10.58 DRV.REBOOT	416
19.10.59 DRV.RSTVAR	417
19.10.60 DRV.RUNTIME	418
19.10.61 DRV.SETUPREQBITS	419
19.10.62 DRV.SETUPREQLIST	421
19.10.63 DRV.STOP	422
19.10.64 DRV.TEMPERATURES	423
19.10.65 DRV.TYPE	424
19.10.66 DRV.VER	425
19.10.67 DRV.VERIMAGE	426
19.10.68 DRV.WARNING1 to DRV.WARNING3	427
19.10.69 DRV.WARNINGS	428
19.10.70 DRV.ZERO	429
19.11 FAULT Parameters	430
19.11.1 FAULTx.ACTION	431
19.11.2 FAULT176.ACTION, FAULT178.ACTION	432
19.11.3 FAULT570.ACTION	433
19.12 FB1 Parameters	434
19.12.1 FB1.BISSBITS	436
19.12.2 FB1.CALTHRESH	437
19.12.3 FB1.DIAG	438
19.12.4 FB1.ENCRESES	439
19.12.5 FB1.EXTENDEDMULTITURN	440
19.12.6 FB1.FAULTS	441
19.12.7 FB1.HALLSTATE	443
19.12.8 FB1.HALLSTATEU	445

19.12.9 FB1.HALLSTATEV	446
19.12.10 FB1.HALLSTATEW	447
19.12.11 FB1.IDENTIFIED	448
19.12.12 FB1.INITPSAVED	449
19.12.13 FB1.INITPSTATUS	450
19.12.14 FB1.INITPWINDOW	451
19.12.15 FB1.INITSIGNED	452
19.12.16 FB1.LASTIDENTIFIED	453
19.12.17 FB1.MECHPOS	454
19.12.18 FB1.MEMVER	455
19.12.19 FB1.MOTORPHASE	456
19.12.20 FB1.MOTORPOLES	457
19.12.21 FB1.OFFSET	458
19.12.22 FB1.ORIGIN	459
19.12.23 FB1.P	461
19.12.24 FB1.PDIR	462
19.12.25 FB1.PFIND	463
19.12.26 FB1.PFINDCMDU	464
19.12.27 FB1.PIN	465
19.12.28 FB1.POFFSET	466
19.12.29 FB1.POLES	467
19.12.30 FB1.POUT	468
19.12.31 FB1.PSCALE	469
19.12.32 FB1.PUNIT	470
19.12.33 FB1.RESKTR	471
19.12.34 FB1.RESREFPHASE	472
19.12.35 FB1.SELECT	473
19.12.36 FB1.TRACKINGCAL	475
19.12.37 u	476
19.12.38 FB1.USERDWORD0 to FB1.USERDWORD1	478
19.12.39 FB1.USERWORD0 to FB1.USERWORD3	480
19.13 FB3 Parameters	482
19.13.1 FB3.DIR	483
19.13.2 FB3.ENCREC	484

19.13.3 FB3.MODE	485
19.13.4 FB3.MOTORPHASE	486
19.13.5 FB3.MOTORPOLES	487
19.13.6 FB3.P	488
19.13.7 FB3.PDIR	489
19.13.8 FB3.PIN	490
19.13.9 FB3.POFFSET	491
19.13.10 FB3.POUT	492
19.13.11 FB3.PUNIT	493
19.14 FBUS Parameters	494
19.14.1 FBUS.PARAM1 TO FBUS.PARAM10	495
19.14.2 FBUS.PLLSTATE	497
19.14.3 FBUS.PLLTHRESH	498
19.14.4 FBUS.PROTECTION	499
19.14.5 FBUS.REMOTE	501
19.14.6 FBUS.SAMPLEPERIOD	502
19.14.7 FBUS.STATE	503
19.14.8 FBUS.SYNCACT	504
19.14.9 FBUS.SYNCDIST	505
19.14.10 FBUS.SYNCWND	506
19.14.11 FBUS.TYPE	507
19.15 GUI Parameters	508
19.15.1 GUI.DISPLAY	509
19.15.2 GUI.DISPLAYS	510
19.15.3 GUI.PARAM01	511
19.15.4 GUI.PARAM02	512
19.15.5 GUI.PARAM03	513
19.15.6 GUI.PARAM04	514
19.15.7 GUI.PARAM05	515
19.15.8 GUI.PARAM06	516
19.15.9 GUI.PARAM07	517
19.15.10 GUI.PARAM08	518
19.15.11 GUI.PARAM09	519
19.15.12 GUI.PARAM10	520

19.16 HWLS Parameters	521
19.16.1 HWLS.NEGSTATE	522
19.16.2 HWLS.POSSTATE	523
19.17 IL Parameters	524
19.17.1 IL.BUSFF	526
19.17.2 IL.CMD	527
19.17.3 IL.CMDACC	528
19.17.4 IL.CMDU	529
19.17.5 IL.DCMD	530
19.17.6 IL.DFB	531
19.17.7 IL.DIFOLD	532
19.17.8 IL.FB	533
19.17.9 IL.FBSOURCE	534
19.17.10 IL.FF	535
19.17.11 IL.FOLDFTHRESH	536
19.17.12 IL.FOLDFTHRESHU	537
19.17.13 IL.FOLDWTHRESH	538
19.17.14 IL.FRCTION	539
19.17.15 IL.IFOLD	540
19.17.16 IL.IUFB	541
19.17.17 IL.IVFB	542
19.17.18 IL.KACCCFF	543
19.17.19 IL.KBUSFF	544
19.17.20 IL.KP	545
19.17.21 IL.KPDRATIO	546
19.17.22 IL.KPLOOKUPINDEX	547
19.17.23 IL.KPLOOKUPVALUE	548
19.17.24 IL.KPLOOKUPVALUES	549
19.17.25 IL.KVFF	550
19.17.26 IL.LIMITN	551
19.17.27 IL.LIMITP	552
19.17.28 IL.MFOLDD	553
19.17.29 IL.MFOLDER	554
19.17.30 IL.MFOLDT	555

19.17.31 IL.MI2T	556
19.17.32 IL.MI2TWTHRESH	557
19.17.33 IL.MIFOLD	558
19.17.34 IL.MIMODE	559
19.17.35 IL.OFFSET	560
19.17.36 IL.VCMD	561
19.17.37 IL.VUFB	562
19.17.38 IL.VVFB	563
19.18 IP Parameters	564
19.18.1 IP.ADDRESS	565
19.18.2 IP.GATEWAY	566
19.18.3 IP.MODE	567
19.18.4 IP.RESET	568
19.18.5 IP.SUBNET	569
19.19 LOAD Parameters	570
19.19.1 LOAD.INERTIA	571
19.20 MOTOR Parameters	572
19.20.1 MOTOR.AUTASET	574
19.20.2 MOTOR.BRAKE	576
19.20.3 MOTOR.BRAKEIMM	577
19.20.4 MOTOR.BRAKERLS	578
19.20.5 MOTOR.BRAKESTATE	579
19.20.6 MOTOR.CTF0	580
19.20.7 MOTOR.FIELDWEAKENING	581
19.20.8 MOTOR.ICONT	582
19.20.9 MOTOR.IDDATAVALID	583
19.20.10 MOTOR.IDMAX	584
19.20.11 MOTOR.IMID	585
19.20.12 MOTOR.IMTR	586
19.20.13 MOTOR.INERTIA	588
19.20.14 MOTOR.IPEAK	589
19.20.15 MOTOR.KE	590
19.20.16 MOTOR.KT	591
19.20.17 MOTOR.LDLL	592

19.20.18 MOTOR.LISAT	593
19.20.19 MOTOR.LQLL	594
19.20.20 MOTOR.NAME	595
19.20.21 MOTOR.PHASE	596
19.20.22 MOTOR.PHSADV1	597
19.20.23 MOTOR.PHSADV2	598
19.20.24 MOTOR.PITCH	599
19.20.25 MOTOR.POLES	600
19.20.26 MOTOR.R	601
19.20.27 MOTOR.RTYPE	602
19.20.28 MOTOR.SUPPORTEDPARAMS	603
19.20.29 MOTOR.TBRAKEAPP	604
19.20.30 MOTOR.TBRAKERLS	605
19.20.31 MOTOR.TBRAKETO	606
19.20.32 MOTOR.TEMP	607
19.20.33 MOTOR.TEMPC	608
19.20.34 MOTOR.TEMPFAULT	609
19.20.35 MOTOR.TEMPWARN	610
19.20.36 MOTOR.TYPE	611
19.20.37 MOTOR.VMAX	613
19.20.38 MOTOR.VOLTMAX	614
19.20.39 MOTOR.VOLTMIN	615
19.20.40 MOTOR.VOLTRATED	616
19.20.41 MOTOR.VRATED	617
19.21 PL Parameters	618
19.21.1 PL.CMD	619
19.21.2 PL.ERR	620
19.21.3 PL.ERRFTHRESH	621
19.21.4 PL.ERRMODE	623
19.21.5 PL.ERRWTHRESH	624
19.21.6 PL.FB	625
19.21.7 PL.FBSOURCE	626
19.21.8 PL.FILTERTIME	627
19.21.9 PL.INTINMAX	628

19.21.10 PL.INTOUTMAX	630
19.21.11 PL.KI	632
19.21.12 PL.KP	633
19.21.13 PL.PDELAY	634
19.22 REC Parameters	635
19.22.1 REC.ACTIVE	636
19.22.2 REC.CH1 to REC.CH6	637
19.22.3 REC.DONE	638
19.22.4 REC.GAP	639
19.22.5 REC.NUMPOINTS	640
19.22.6 REC.OFF	641
19.22.7 REC.RECPRMLIST	642
19.22.8 REC.RETRIEVE	643
19.22.9 REC.RETRIEVEDATA	644
19.22.10 REC.RETRIEVEFRMT	646
19.22.11 REC.RETRIEVEHDR	647
19.22.12 REC.RETRIEVESIZE	648
19.22.13 REC.STOPTYPE	649
19.22.14 REC.TRIG	650
19.22.15 REC.TRIGPARAM	651
19.22.16 REC.TRIGPOS	652
19.22.17 REC.TRIGPRMLIST	654
19.22.18 REC.TRIGSLOPE	655
19.22.19 REC.TRIGTYPE	656
19.22.20 REC.TRIGVAL	657
19.23 REGEN Parameters	658
19.23.1 REGEN.POWER	659
19.23.2 REGEN.POWERFILTERED	660
19.23.3 REGEN.REXT	661
19.23.4 REGEN.TEXT	662
19.23.5 REGEN.TYPE	663
19.23.6 REGEN.WATTEXT	664
19.24 SM Parameters	665
19.24.1 SM.ACC	666

19.24.2 SM.DEC	667
19.24.3 SM.I1	668
19.24.4 SM.I2	669
19.24.5 SM.MODE	670
19.24.6 SM.MOVE	673
19.24.7 SM.T1	674
19.24.8 SM.T2	675
19.24.9 SM.V1	676
19.24.10 SM.V2	677
19.25 STO Parameters	678
19.25.1 STO.STATE	679
19.26 SWLS Parameters	680
19.26.1 SWLS.EN	681
19.26.2 SWLS.LIMIT0	682
19.26.3 SWLS.LIMIT1	683
19.26.4 SWLS.STATE	684
19.27 TEMP Parameters	685
19.27.1 TEMP.CONTROL	686
19.27.2 TEMP.POWER1 to TEMP.POWER3	687
19.28 USER Parameters	688
19.28.1 USER.INT1 to USER.INT24	689
19.29 VBUS Parameters	690
19.29.1 VBUS.HALFVOLT	691
19.29.2 VBUS.OVFTHRESH	692
19.29.3 VBUS.OVWTHRESH	693
19.29.4 VBUS.RMSLIMIT	694
19.29.5 VBUS.UVFTHRESH	695
19.29.6 VBUS.UVMODE	696
19.29.7 VBUS.UVWTHRESH	697
19.29.8 VBUS.VALUE	698
19.30 VL Parameters	699
19.30.1 VL.ARPF1 TO VL.ARPF4	700
19.30.2 VL.ARPQ1 TO VL.ARPQ4	702
19.30.3 VL.ARTYPE1 TO VL.ARTYPE4	704

19.30.4 VL.ARZF1 TO VL.ARZF4	705
19.30.5 VL.ARZQ1 TO VL.ARZQ4	706
19.30.6 VL.BUSFF	707
19.30.7 VL.CMD	708
19.30.8 VL.COMDU	709
19.30.9 VL.ERR	710
19.30.10 VL.FB	711
19.30.11 VL.FBFILTER	712
19.30.12 VL.FBSOURCE	713
19.30.13 VL.FBUNFILTERED	714
19.30.14 VL.FF	715
19.30.15 VL.FFDELAY	716
19.30.16 VL.GENMODE	717
19.30.17 VL.KBUSFF	718
19.30.18 VL.KI	719
19.30.19 VL.KO	720
19.30.20 VL.KP	721
19.30.21 VL.KVFF	723
19.30.22 VL.LIMITN	724
19.30.23 VL.LIMITP	726
19.30.24 VL.LMJR	727
19.30.25 VL.MODEL	728
19.30.26 VL.OBSBW	729
19.30.27 VL.OBSMODE	730
19.30.28 VL.THRESH	731
19.30.29 VL.VFTHRESH	733
19.31 WS Parameters	734
19.31.1 WS.ARM	735
19.31.2 WS.CHECKMODE	736
19.31.3 WS.CHECKT	737
19.31.4 WS.CHECKV	738
19.31.5 WS.DISARM	739
19.31.6 WS.DISTMAX	740
19.31.7 WS.DISTMIN	741

19.31.8 WS.FREQ	742
19.31.9 WS.IMAX	743
19.31.10 WS.MODE	744
19.31.11 WS.NUMLOOPS	745
19.31.12 WS.STATE	746
19.31.13 WS.T	747
19.31.14 WS.TDELAY1	748
19.31.15 WS.TDELAY2	749
19.31.16 WS.TDELAY3	750
19.31.17 WS.TDELAY4	751
19.31.18 WS.TIRAMP	752
19.31.19 WS.TSTANDSTILL	753
19.31.20 WS.VTHRESH	754

19.1 About the Parameter and Command Reference Guide

This reference guide provides descriptive information about each parameter and command used in the drive firmware. Parameters and commands are used to configure the drive or to return status information from the drive using the EWV¹ terminal screen. The use of these parameters and commands to perform various drive functions is detailed in related sections of the AKD PDMM User Guide.

Drive parameter and command categories include the following:

AOUT Parameters (→ p. 260)	FB3 Parameters (→ p. 482)	REC Parameters (→ p. 635)
BODE Parameters (→ p. 278)	FBUS Parameters (→ p. 494)	REGEN Parameters (→ p. 658)
CS Parameters (→ p. 313)	GUI Parameters (→ p. 508)	SM Parameters (→ p. 665)
DIN Parameters (→ p. 318)	HWLS Parameters (→ p. 521)	STO Parameters (→ p. 678)
DOUT Parameters (→ p. 336)	IL Parameters (→ p. 524)	SWLS Parameters (→ p. 680)
DRV Parameters (→ p. 351)	IP Parameters (→ p. 564)	USER Parameters (→ p. 688)
FAULT Parameters (→ p. 430)	LOAD Parameters (→ p. 570)	TEMP Parameters (→ p. 685)
FB1 Parameters (→ p. 434)	MOTOR Parameters (→ p. 572)	VBUS Parameters (→ p. 690)
	PL Parameters (→ p. 618)	VL Parameters (→ p. 699)
		WS Parameters (→ p. 734)

A summary table of information for all parameters and commands is also available:

[Summary of Parameters and Commands](#)

For each parameter or command, this reference guide presents the following tables of information, followed by a description of the command, examples, and links to related information in the User Guide, as appropriate.

¹Embedded Workbench Views

General Information	
Type	One of four types: <ul style="list-style-type: none"> • Command: Action or W/O command. • NV Parameter: R/W and stored in nonvolatile (NV) memory • R/W Parameter: Can be either read from or written to the drive. • R/O Parameter: Can only be read from the drive
Description	Brief description of the parameter or command and notes if the parameter or command is not active in all opmodes.
Units	Appropriate units
Range	Permissible range; multiple ranges are sometimes present.
Default Value	Determined at setup process time or motor ID; otherwise set to 0.010.
Data Type	Integer, Boolean, Float, or String
See Also	Links to related information such as other parameters, block diagrams, schematics, or other sections of the product manual.
Start Version	The minimum firmware version number required to use the parameter or command

Fieldbus	Index/Subindex	Object Start Version
Fieldbus type, such as EtherCAT COE and CANopen .	Index/subindex values for the parameter or command. The index value may be linked to the Object Dictionary for each fieldbus, if the object dictionary contains more detailed information about the object.	The minimum firmware version number required to use the fieldbus.

Additional data types may include the following:

Type	Description
Error	Illegal type=0
b	Boolean
U8	8 x unsigned numbers
S8	8 x signed numbers
U16	16 x unsigned numbers
S16	16 x signed numbers
U32	32 x unsigned numbers
S32	32 x signed numbers
U64	64 x unsigned numbers
S64	64 x signed numbers

19.1.1 Parameter and Command Naming Conventions

Abbreviation	Term
ACC	Acceleration
APP	Apply
CLR	Clear
CS	Controlled Stop

Abbreviation	Term
I	Current
D	Current d-component
DEC	Deceleration
DIR	Direction
DIS	Disable
DIST	Distance
EMUE	Emulated encoder
EN	Enable
ERR	Error
F	Fault
FB	Feedback
FF	Feedforward
K	Gain
INT	Integrator
LIM	Limit
L	Loop
MAX	Maximum
MIN	Minimum
N	Negative
NV	Nonvolatile
P	Position, Proportional, Positive
RLS	Release
R	Resistance
STATE	Status, State, Stat
THRESH	Threshold
T	Time
TMAX	Timeout
U	User
V	Velocity, Volt
W	Warning

19.1.2 Summary of Parameters and Commands

This table contains an alphabetical list of parameters and commands, with a brief description for each. The parameter name and description are linked to the parameter tables. Generally speaking, all parameters and commands are active in all opmodes, with the following exceptions:

Parameter or Command	Active in Opmodes
GEAR (all parameters and commands)	2 (position) only
HOME (all parameters and commands)	2 (position) only
MT (all parameters and commands)	2 (position) only

Parameter or Command	Active in Opmodes
SM.I1, SM.I2	0 (torque) only
SM.V1, SM.V2	1 (velocity) only
SM.VPM1, SM.VPM2	2 (position) only
VL (all parameters and commands)	1 (velocity) and 2 (position) only

Parameter or Command	Type	Description
Analog Output (AOUT)		
AOUT.CUTOFF (→ p. 261)	NV	Sets the analog output low-pass filter cutoff frequency.
AOUT.ISCALE (→ p. 265)	NV	Sets the analog current scale factor.
AOUT.MODE (→ p. 266)	NV	Sets the analog output mode.
AOUT.OFFSET (→ p. 267)	NV	Sets the analog output offset.
AOUT.PSCALE (→ p. 268)	NV	Sets the analog position scale factor.
AOUT.VALUE (→ p. 269)	NV	Reads the analog output value.
AOUT.VALUEU (→ p. 270)	R/W	Sets the analog output value.
AOUT.VSCALE (→ p. 271)	NV	Sets the velocity scale factor for analog output.
Analog Output 2 (AOUT2)		
AOUT2.CUTOFF (→ p. 273)	NV	Sets the analog output 2 low-pass filter cutoff frequency.
AOUT2.MODE (→ p. 274)	NV	Sets the analog output 2 mode.
AOUT2.OFFSET (→ p. 275)	NV	Sets the analog output 2 offset.
AOUT2.VALUE (→ p. 276)	NV	Reads the analog output 2 value.
AOUT2.VALUEU (→ p. 277)	R/W	Sets the analog output 2 value.
Bode plot (BODE)		
BODE.EXCITEGAP (→ p. 279)	R/W	Controls how often the excitation is updated.
BODE.FREQ (→ p. 280)	R/W	Sets the frequency of the sine excitation source.
BODE.IAMP (→ p. 281)	R/W	Sets current command value used during the Bode procedure.
BODE.IFLIMIT (→ p. 282)	R/W	Sets the current fault duration limit in seconds for the BODE.MODE 5 stability test.
BODE.IFTHRESH (→ p. 283)	R/W	Sets the current fault threshold for the BODE.MODE 5 stability test.
BODE.INJECTPOINT (→ p. 284)	R/W	Sets whether the excitation uses current or velocity excitation type.
BODE.MODE (→ p. 285)	R/W	Sets the mode of the excitation.
BODE.MODETIMER (→ p. 288)	R/W	Sets the watchdog timer of the excitation.
BODE.PRBDDEPTH (→ p. 290)	R/W	Sets the length of the PRB signal before it repeats.
BODE.VAMP (→ p. 291)	R/W	Sets the amplitude of the excitation when in velocity mode.
BODE.VFLIMIT (→ p. 292)	R/W	Sets the velocity fault duration limit (seconds) for the BODE.MODE 5 stability test
BODE.VFTHRESH (→ p. 293)	R/W	Sets the current fault threshold for the BODE.MODE 5 stability test.
Controlled Stop (CS)		

Parameter or Command	Type	Description
CS.DEC (→ p. 314)	NV	Sets the deceleration value for the controlled stop process.
CS.STATE (→ p. 315)	NV	Returns the internal status of the controlled stop process.
CS.TO (→ p. 316)	NV	Sets the time value for the drive velocity to be within CS.VTHRESH (→ p. 317).
CS.VTHRESH (→ p. 317)	NV	Sets the velocity threshold for the controlled stop.
Digital Input (DIN)		
DIN.HCMD1 TO DIN.HCMD4 (→ p. 319)	NV	A buffer of commands to be used in digital input "command buffer" mode.
DIN.LCMD1 to DIN.LCMD4 (→ p. 320)	NV	A buffer of commands to be used in digital input "command buffer" mode.
DIN.ROTARY (→ P. 321)	R/O	Reads the rotary knob value.
DIN.STATES (→ P. 322)	R/O	Reads the digital input states.
DIN1.FILTER TO DIN7.FILTER (→ p. 323)	R/W	Filter mode for digital inputs 1 to 7.
DIO9.INV to DIO11.INV (→ p. 334)	R/W	Inverting the output voltage of the IO, when in the output direction.
DIN1.MODE TO DIN7.MODE (→ p. 325)	NV	Sets the digital input modes.
DIN1.PARAM TO DIN7.PARAM (→ p. 327)	R/W	Sets a value used as an extra parameter for digital inputs nodes.
DIN1.STATE TO DIN7.STATE (→ p. 329)	R/O	Reads a specific digital input state.
DIN21.FILTER to DIN32.FILTER (→ p. 331)	R/W	Filter mode for digital inputs 21 to 32.
DIN21.STATE to DIN32.STATE (→ p. 332)	R/O	Reads a specific digital input state.
Digital Output (DOUT)		
DOUT.CTRL (→ P. 337)	NV	Sets the source of digital output(s) (firmware or fieldbus).
DOUT.RELAYMODE (→ p. 338)	R/W	Indicates faults relay mode.
DOUT.STATES (→ P. 339)	R/O	Reads the state of the digital output(s).
DOUTx.MODE	NV	Sets the digital output mode.
DOUT1.PARAM AND DOUT2.PARAM (→ p. 341)	NV	Sets extra parameters for the digital output(s).
DOUT1.STATE AND DOUT2.STATE (→ p. 343)	R/O	Reads the digital output state.
DOUT1.STATEU AND DOUT2.STATEU (→ p. 344)	R/W	Sets the state of the digital output node.
DOUT21.STATE to DOUT32.STATE (→ p. 349)	R/O	Reads the digital output state.
DOUT21.STATEU to DOUT32.STATEU (→ p. 350)	R/W	Sets the state of the digital output node.
Drive (DRV)		

Parameter or Command	Type	Description
DRV.ACC (→ P. 354)	NV	Describes the acceleration ramp for the velocity loop.
DRV.ACTIVE (→ P. 356)	R/O	Reads the enable status of an axis.
DRV.BLINKDISPLAY (→ P. 357)	Command	Causes the display to blink for 10 seconds.
DRV.BOOTTIME (→ p. 358)	R/O	Returns the time when the current session booted up.
DRV.CLRFAULTHIST (→ P. 359)	Command	Clears the fault history log in the NV.
DRV.CLRFAULTS (→ P. 360)	Command	Tries to clear all active faults in the drive.
DRV.CMDDELAY (→ p. 361)	R/W	Issues a delay before next command is executed.
DRV.CMDSOURCE (→ P. 362)	NV	Sets the command source (service, fieldbus, analog input, gearing, digital, or Bode).
DRV.CRASHDUMP (→ p. 363)	Command	Retrieves diagnostic information after the drive crashes.
DRV.DBILIMIT (→ p. 365)	NV	Sets the maximum amplitude of the current for dynamic braking.
DRV.DEC (→ P. 366)	NV	Sets the deceleration value for the velocity loop.
DRV.DIFVAR (→ p. 368)	R/O	Lists all parameters which differ from their default value.
DRV.DIR (→ p. 369)	R/W	Changes drive direction.
DRV.DIS (→ P. 371)	Command	Disables the axis (software).
DRV.DISMODE (→ p. 372)	NV	Selects among disable immediately or stop and then disable options.
DRV.DISSOURCES (→ P. 373)	R/O	Returns the possible reason for a drive disable.
DRV.DISSOURCESMASK (→ p. 374)	R/O	Returns a bitmap of all bits in DRV.DISSOURCES that can be set to one on a given drive.
DRV.DISTO (→ p. 375)	R/W	Sets the emergency timeout
DRV.DOWNLOADALLOWED (→ p. 376)	R/O	Returns whether the drive is in a safe state to begin a firmware download.
DRV.EMUEDIR (→ p. 378)	R/W	Sets the direction of the emulated encoder output (EEO) signal.
DRV.EMUEMODE (→ p. 379)	R/W	Sets the mode of the emulated encoder output (EEO) connector.
DRV.EMUEMTURN (→ p. 381)	R/W	Defines the location of the index pulse on the EEO (emulated encoder output) when DRV.EMUEMODE=2.
DRV.EMUEPULSEWIDTH (→ p. 382)		Sets the encoder output pulse width for modes 6 to 7.
DRV.EMUERES (→ p. 383)	R/W	Sets the resolution of the EEO (emulated encoder output).
DRV.EMUEZOFFSET (→ p. 384)	R/W	Sets the location of the EEO (emulated encoder output) index pulse (when DRV.EMUEMODE=1).
DRV.EN (→ P. 385)	Command	Enables the axis (software).
DRV.ENDEFAULT (→ p. 386)	R/W	Sets the default state of the software enable.
DRV.ERRORLIST (→ p. 387)	R/O	Prints a list of all possible error codes and error text.
DRV.FAULTDISPLAYMODE (→ p. 388)	NV	Sets the fault display mode.
DRV.FAULTHIST (→ P. 389)	R/O	Reads the last 50 faults from NV memory.

Parameter or Command	Type	Description
DRV.FAULTS (→ P. 391)	R/O	Reads the active faults.
DRV.FAULT1 to DRV.FAULT10 (→ p. 390)	R/O	Location of fault codes for any active fault conditions.
DRV.HANDWHEEL	R/O	Reads the EEO input value.
DRV.HANDWHEELSRC (→ p. 392)	NV	Selects the feedback for handwheel operation.
DRV.HELP (→ P. 393)	R/O	Reads the minimum, maximum, and default values for a specific parameter or command.
DRV.HELPALL (→ p. 394)	R/O	Retrieves the minimum, maximum, default, and actual values for all available parameters and commands.
DRV.HWENABLE (→ p. 395)	R/O	Status of the hardware enable.
DRV.HWENDELAY (→ p. 396)	NV	Delay time between inactive Hardware Enable input and drive disable.
DRV.HWENMODE (→ p. 397)	R/W	Selects the action that the hardware enable digital input will perform.
DRV.ICONT (→ P. 398)	R/O	Reads the continuous rated current value.
DRV.INFO (→ P. 399)	R/O	Reads general information about the drive.
DRV.IPEAK (→ P. 401)	R/O	Reads the peak rated current value.
DRV.IZERO (→ p. 402)	R/W	Sets the current that will be used during the DRV.ZERO procedure.
DRV.LIST (→ P. 403)	R/O	Reads the list of available parameters and commands.
DRV.LOGICVOLTS (→ p. 404)	R/O	Reads the logic voltages.
DRV.MOTIONDISSOURCES (→ p. 407)	R/O	Returns some causes of a motion disable.
DRV.NAME (→ P. 408)	NV	Sets and reads the name of the drive.
DRV.NVCHECK (→ p. 409)	R/O	NV Parameter Checksum
DRV.NVLIST (→ P. 410)	R/O	Lists the NV parameters and values from the RAM.
DRV.NVLOAD (→ p. 411)	W/O	Loads all data from the NV memory of the drive into the RAM parameters.
DRV.NVSAVE (→ P. 412)	Command	Saves the drive parameters from the RAM to the NV memory.
DRV.ONTIME (→ p. 413)	R/O	Returns how long the drive has been running since last power up.
DRV.OPMODE (→ P. 414)	NV	Sets the drive operation mode (current, velocity, or position).
DRV.READFORMAT (→ P. 415)	R/W	Sets the value returned to either decimal or hexadecimal.
DRV.REBOOT (→ p. 416)	Command	Performs a software reboot.
DRV.RSTVAR (→ P. 417)	Command	Sets default values in the drive without re-booting the drive and without resetting the NV memory.
DRV.RUNTIME (→ P. 418)	R/O	Returns how long the drive has been running since first activated.
DRV.SETUPREQBITS (→ p. 419)	R/O	Reads the bitwise set status of parameters that must be set before the drive can be enabled.

Parameter or Command	Type	Description
DRV.SETUPREQLIST (→ p. 421)	R/O	Reads the list of parameters that must be set before the drive can be enabled.
DRV.STOP (→ P. 422)	Command	This command stops all drive motion.
DRV.TEMPERATURES (→ p. 423)	R/O	Reads the temperature of drive components.
DRV.TIME	R/W	A continuous time counter in the drive.
DRV.TYPE (→ p. 424)	R/O	Selects the operational fieldbus on CC drive models.
DRV.VER (→ P. 425)	R/O	Reads the drive version.
DRV.VERIMAGE (→ P. 426)	R/O	Returns the version data from each image.
DRV.WARNINGS (→ p. 428)	R/O	Reads the active warnings.
DRV.WARNING1 to DRV.WARNING3 (→ p. 427)	R/O	Location of fault codes for any active warning conditions.
DRV.ZERO (→ p. 429)	R/W	Sets the zero mode. The procedure is activated when the drive is enabled.
Fault (FAULT)		
FAULTx.ACTION (→ p. 431)	R/W	Gets/Sets the Fault Action for Fault 130, 131, 132, 134, 139, 451, and 702.
FAULT176.ACTION, FAULT178.ACTION (→ p. 432)	R/W	Gets/Sets the fault action for either fault 176 or 178.
FAULT570.ACTION (→ p. 433)	R/W	Gets/Sets the fault action for fault 570.
Feedback 1 (FB1)		
FB1.BISSBITS (→ p. 436)	NV	Specifies the number of Biss Sensor (Position) Bits for the BiSS Mode C encoder in use.
FB1.CALTHRESH (→ p. 437)	NV	Sets the velocity threshold at which the auto-calibration function will continuously update error correction for sin/cos encoders.
FB1.DIAG (→ p. 438)	R/O	Returns feedback diagnostic information.
FB1.ENCREC (→ P. 439)	NV	Sets the resolution of the motor encoder.
FB1.FAULTS (→ p. 441)	R/O	Returns a string describing the root cause of Fault 467.
FB1.HALLSTATE (→ P. 443)	R/O	Reads the Hall switch values (encoder feedback only).
FB1.HALLSTATEU (→ p. 445)	R/O	Reads the state of Hall switch U.
FB1.HALLSTATEV (→ p. 446)	R/O	Reads the state of Hall switch V.
FB1.HALLSTATEW (→ p. 447)	R/O	Reads the state of Hall switch W.
FB1.IDENTIFIED (→ P. 448)	R/O	Reads the type of feedback device used by the drive/motor.
FB1.INITPSAVED (→ p. 449)	R/O	Reads position saved at last power down.
FB1.INITPSTATUS (→ p. 450)	R/O	Reads result of initial position comparison.
FB1.INITPWINDOW (→ p. 451)	R/W	Reads and writes size of the initial position comparison window.
FB1.INITSIGNED (→ p. 452)	NV	Sets initial feedback value as signed or unsigned.
FB1.LASTIDENTIFIED (→ p. 453)	NV	Stores the feedback type auto-detected during the last feedback initialization. Auto-detection will look for this type first.

Parameter or Command	Type	Description
FB1.MECHPOS (→ P. 454)	R/O	Reads the mechanical position.
FB1.MEMVER (→ P. 455)	R/O	Returns the memory feedback version.
FB1.MOTORPHASE (→ p. 456)	NV	Sets the motor phase of the motor associated with FB1.
FB1.MOTORPOLES (→ p. 457)	NV	Sets the number of motor poles associated with FB1.
FB1.OFFSET (→ p. 458)	NV	Sets position feedback offset.
FB1.ORIGIN (→ p. 459)	NV	Adds to the initial feedback position.
FB1.P (→ p. 461)	R/O	Reads position from the primary feedback.
FB1.PDIR (→ p. 462)	NV	Sets the counting direction for feedback channel 1.
FB1.PFIND (→ p. 463)	R/W	A procedure that allows the user to find the commutation angle for encoder feedback, which has no halls.
FB1.PFINDCMDU (→ p. 464)	R/W	Current value used during the phase finding procedure (PFB.PFIND=1)
FB1.PIN (→ p. 465)	NV	Sets gear IN for FB1.P (→ p. 461).
FB1.POFFSET (→ p. 466)	NV	Sets the offset for primary feedback.
FB1.POLES (→ P. 467)	R/O	Reads the number of feedback poles.
FB1.POUT (→ p. 468)	NV	Sets gear IN for FB1.P (→ p. 461).
FB1.PSCALE (→ p. 469)	R/W	Sets position scaling value for fieldbus transferred position objects.
FB1.PUNIT (→ p. 470)	NV	Sets the unit for FB1.P.
FB1.RESKTR (→ p. 471)	NV	Sets the resolver nominal transformation ratio.
FB1.RESREFPHASE (→ p. 472)	NV	Sets the electrical degrees of phase lag in the resolver.
FB1.SELECT (→ P. 473)	NV	Sets user entered type or identified type (-1).
FB1.TRACKINGCAL (→ p. 475)	NV	Controls tracking calibration algorithm.
u (→ p. 476)	R/W	Reads and writes data stored in eight 8 bit bytes in an Endat or Hiperface feedback device.
FB1.USERDWORD0 to FB1.USERDWORD1 (→ p. 478)	R/W	Reads and writes data stored in two 32 bit words in an Endat or Hiperface feedback device.
FB1.USERWORD0 to FB1.USERWORD3 (→ p. 480)	R/W	Reads and writes data stored in four 16 bit words in an Endat or Hiperface feedback device.
Feedback 3 (FB3)		
FB3.DIR (→ p. 483)	NV	Sets the counting direction for the position feedback when PL.FBSOURCE = 2. (→ p. 483)
FB3.ENCRESES (→ p. 484)	NV	Sets the resolution of the motor encoder for feedback 3.
FB3.MODE (→ p. 485)	NV	Selects the type of feedback connected to X9.
FB3.MOTORPHASE (→ p. 486)	NV	Sets the motor phase of the motor associated with FB3.
FB3.MOTORPOLES (→ p. 487)	NV	Sets the number of motor poles associated with FB3.
FB3.P (→ p. 488)	RO	Reads position from the tertiary feedback.
FB3.PDIR (→ p. 489)	NV	Sets the counting direction for feedback channel 3.
FB3.PIN (→ p. 490)	NV	Sets gear IN for FB3.P (→ p. 488).
FB3.POFFSET (→ p. 491)	NV	Sets the offset for tertiary feedback.
FB3.POUT (→ p. 492)	NV	Sets gear IN for FB3.P (→ p. 488).
FB3.PUNIT (→ p. 493)	NV	Sets the unit for FB3.P.

Parameter or Command	Type	Description
Fieldbus (FBUS)		
FBUS.PARAM1 TO FBUS.PARAM10 (→ p. 495)	NV	Set fieldbus specific meanings.
FBUS.PLLSTATE (→ p. 497)	R/O	Returns the status of the PLL
FBUS.PLLTHRESH (→ p. 498)	NV	Sets number of successful synchronized cycles needed to lock the PLL.
FBUS.PROTECTION (→ p. 499)	R/W	Controls which parameters are blocked from being accessed through telnet while a fieldbus is operational.
FBUS.SAMPLEPERIOD (→ p. 502)	NV	Sets fieldbus sample period.
FBUS.STATE (→ p. 503)	R/O	Reads the state of the fieldbus.
FBUS.SYNCACT (→ p. 504)	R/O	Reads actual distance from the desired sync distance.
FBUS.SYNCDIST (→ p. 505)	NV	Sets time target for synchronization.
FBUS.SYNCWND (→ p. 506)	NV	Sets symmetrically arranged window around the desired sync distance.
FBUS.TYPE (→ p. 507)	R/O	Shows the active fieldbus type.
EWV¹ (GUI) Parameters		
GUI.DISPLAY (→ P. 509)	R/O	Reads drive display data.
GUI.DISPLAYS (→ p. 510)	R/O	Reads drive display data.
GUI.PARAM01 (→ P. 511)	NV	Used by the GUI to store data.
GUI.PARAM02 (→ P. 512)	NV	Used by the GUI to store data.
GUI.PARAM03 (→ P. 513)	NV	Used by the GUI to store data.
GUI.PARAM04 (→ P. 514)	NV	Used by the GUI to store data.
GUI.PARAM05 (→ P. 515)	NV	Used by the GUI to store data.
GUI.PARAM06 (→ P. 516)	NV	Used by the GUI to store data.
GUI.PARAM07 (→ P. 517)	NV	Used by the GUI to store data.
GUI.PARAM08 (→ P. 518)	NV	Used by the GUI to store data.
GUI.PARAM09 (→ P. 519)	NV	Used by the GUI to store data.
GUI.PARAM10 (→ P. 520)	NV	Used by the GUI to store data.
Hardware Limit Switch (HWLS)		
HWLS.NEGSTATE (→ p. 522)	R/O	Reads the status of the negative hardware limit switch.
HWLS.POSSTATE (→ p. 523)	R/O	Reads the status of the positive hardware limit switch.
Current Loop (IL)		
IL.BUSFF (→ p. 526)	R/O	Displays the current feedforward value injected by the fieldbus.
IL.CMD (→ P. 527)	R/O	Reads the value of the q-component current command.
IL.CMDACC (→ p. 528)	R/O	Returns the commanded acceleration from the trajectory generator.
IL.CMDU (→ P. 529)	R/W	Sets the user current command.
IL.DCMD (→ p. 530)	R/O	Reads the value of the d-component current controller inside the FPGA.

Parameter or Command	Type	Description
IL.DFB (→ P. 531)	R/O	Reads the actual value of the d-component current.
IL.DIFOLD (→ P. 532)	R/O	Reads the drive foldback current limit.
IL.FB (→ P. 533)	R/O	Reads the actual value of the q-component current.
IL.FBSOURCE (→ p. 534)	R/W	Sets the feedback source for the current loop. Only applies when MOTOR.TYPE = 4.
IL.FF (→ p. 535)	R/O	Reads the current loop overall feedforward value.
IL.FOLDFTHRESH (→ P. 536)	NV	Reads the foldback fault level.
IL.FOLDFTHRESHU (→ p. 537)	NV	Sets the user value for the foldback fault level.
IL.FOLDWTHRESH (→ P. 538)	NV	Sets the foldback warning level.
IL.IFOLD (→ p. 540)	R/O	Reads the overall foldback current limit.
IL.IUFB (→ P. 541)	R/O	Reads the sigma-delta measured current in the u-winding of the motor.
IL.KACFF (→ p. 543)	R/W	Sets current loop acceleration feedforward gain value
IL.KBUSFF (→ p. 544)	R/W	Current loops fieldbus injected feed-forward gain
IL.KP (→ P. 545)	NV	Sets the proportional gain of the q-component of the PI regulator.
IL.KPDRATIO (→ P. 546)	NV	Sets the proportional gain of the d-component current PI-regulator as a percentage of IL.KP
IL.KPLOOKUPINDEX (→ p. 547)	R/W	Sets the index into the Current Loop Gain Scheduling Table.
IL.KPLOOKUPVALUE (→ p. 548)	R/W	Sets the value of the current loop gain scheduling index.
IL.KPLOOKUPVALUES (→ p. 549)	R/W	Gets the Current Loop Gain Scheduling Table.
IL.KVFF (→ p. 550)	R/W	Current loop velocity feed-forward gain.
IL.LIMITN (→ P. 551)	NV	Sets the negative user (application-specific) current limit.
IL.LIMITP (→ P. 552)	NV	Sets the positive user (application-specific) current limit.
IL.MFOLDD (→ P. 553)	NV	Sets the motor foldback maximum time at motor peak current.
IL.MFOLDR (→ P. 554)	R/O	Sets the motor foldback recovery time.
IL.MFOLDT (→ P. 555)	NV	Sets the motor foldback time constant of the exponential current drop (foldback).
IL.MI2T (→ p. 556)	R/O	Motor I2t load.
IL.MI2TWITHRESH (→ p. 557)	NV	Motor I2t load warning threshold.
IL.MIFOLD (→ P. 558)	R/O	Sets the motor foldback current limit.
IL.MIMODE (→ p. 559)	NV	Motor protection mode.
IL.OFFSET (→ p. 560)	RW	A constant current command added to compensate for gravity.
IL.VCMD (→ P. 561)	R/O	Reads the output of the q-component PI regulator.
IL.VUFB (→ P. 562)	R/O	Reads the measured voltage on the u-winding of the motor.

Parameter or Command	Type	Description
IL.VVFB (→ P. 563)	R/O	Reads the measured voltage on the v-winding of the motor.
IP (Internet Protocol)Parameters		
IP.ADDRESS (→ p. 565)	NV	Gets/Sets the IP address of the drive.
IP.GATEWAY (→ p. 566)	NV	Gets/Sets the gateway IP of the drive.
IP.MODE (→ p. 567)	NV	Sets method of acquiring IP Address.
IP.RESET (→ p. 568)	Command	Implements new IP settings..
IP.SUBNET (→ p. 569)	NV	Gets/Sets the IP subnet mask of the drive.
LOAD Parameters		
LOAD.INERTIA (→ p. 571)	NV	Sets the load inertia.
Motor Parameters		
MOTOR.AUTOSSET (→ p. 574)	NV	Determines which drive parameters are calculated automatically.
MOTOR.BRAKE (→ P. 576)	NV	Sets the presence or absence of a motor brake.
MOTOR.BRAKEIMM (→ p. 577)	NV	Brake Immediately: in the case of a drive disable, apply the brake as soon as the power stage disables.
MOTOR.BRAKERLS (→ p. 578)	Command	Allows a user to release or apply the motor brake.
MOTOR.BRAKESTATE (→ p. 579)	R/O	Reads the actual status of the motor brake.
MOTOR.CTF0 (→ p. 580)	NV	Sets the thermal constant of the motor coil.
MOTOR.FIELDWEAKENING (→ p. 581)	R/W	Allows a surface permanent magnet motor to operate as an interior permanent magnet motor.
MOTOR.ICONT (→ P. 582)	NV	Sets the motor continuous current.
MOTOR.IDDATAVALID (→ p. 583)	R/O	Reports the status of the motor memory.
MOTOR.IDMAX (→ p. 584)	NV	Maximum direct axis current.
MOTOR.IMID (→ p. 585)	R/W	The direct-axis current set point used for induction machine closed-loop control.
MOTOR.IMTR (→ p. 586)	R/W	Rotor time constant.
MOTOR.INERTIA (→ P. 588)	NV	Sets the motor inertia.
MOTOR.IPEAK (→ P. 589)	NV	Sets the motor peak current.
MOTOR.KE (→ p. 590)	NV	Sets the motor back EMF constant.
MOTOR.KT (→ P. 591)	NV	Sets the torque constant of the motor.
MOTOR.LDLL (→ p. 592)	NV	Motor line to line direct axis inductance.
MOTOR.LISAT (→ p. 593)	NV	Motor quadrature axis inductance saturation characteristic.
MOTOR.LQLL (→ P. 594)	NV	Sets the line-to-line motor Lq.
MOTOR.NAME (→ P. 595)	NV	Sets the motor name.
MOTOR.PHASE (→ P. 596)	NV	Sets the motor phase.
MOTOR.PHSADV1 (→ p. 597)	NV	First order phase advance polynomial coefficient.
MOTOR.PHSADV2 (→ p. 598)	NV	Second order phase advance polynomial coefficient.

Parameter or Command	Type	Description
MOTOR.PITCH (→ P. 599)	NV	Sets the motor pitch.
MOTOR.POLES (→ P. 600)	NV	Sets the number of motor poles.
MOTOR.R (→ P. 601)	NV	Sets the stator winding resistance phase-phase in ohms.
MOTOR.RTYPE (→ p. 602)	NV	Defines the type of thermal resistor inside the motor.
MOTOR.SUPPORTEDPARAMS (→ p. 603)	R/O	Lists MOTOR parameters supported by configured motor type.
MOTOR.TBRAKEAPP (→ P. 604)	NV	The delay time used for applying the motor brake.
MOTOR.TBRAKERLS (→ P. 605)	NV	The delay time used for releasing the motor brake.
MOTOR.TBRAKETO (→ p. 606)	NV	Brake apply timeout for vertical axis.
MOTOR.TEMP (→ p. 607)	R/O	Reads the motor temperature represented as the resistance of the motor PTC or NTC.
MOTOR.TEMPC (→ p. 608)	R/O	Reads the motor temperature in degrees Celsius.
MOTOR.TEMPFAULT (→ p. 609)	NV	Sets the motor temperature fault level.
MOTOR.TEMPWARN (→ p. 610)	NV	Sets the motor temperature warning level.
MOTOR.TYPE (→ P. 611)	NV	Sets the motor type.
MOTOR.VMAX (→ P. 613)	NV	Sets the maximum motor speed.
MOTOR.VOLTMAX (→ P. 614)	NV	Sets the motor maximum voltage.
MOTOR.VOLTMIN (→ p. 615)	NV	Sets the minimum voltage for V/f control.
MOTOR.VOLTRATED (→ p. 616)	NV	Sets the motor rated voltage.
MOTOR.VRATED (→ p. 617)	NV	Sets the motor rated velocity (not maximum velocity).
Position Loop (PL)		
PL.CMD (→ P. 619)	NV	Reads the position command directly from the entry to the position loop.
PL.ERR (→ P. 620)	NV	Reads the position error present when the drive is controlling the position loop.
PL.ERRFTHRESH (→ p. 621)	NV	Sets the maximum position error.
PL.ERRMODE (→ p. 623)	R/W	Sets the type of following error warning and fault usage.
PL.ERRWTHRESH (→ p. 624)	NV	Sets the position error warning level.
PL.FB (→ P. 625)	R/O	Reads the position feedback value.
PL.FBSOURCE (→ p. 626)	NV	Sets the feedback source for the position loop.
PL.FILTERTIME (→ p. 627)	R/W	Sets the position command filter period.
PL.INTINMAX (→ P. 628)	NV	Limits the input of the position loop integrator by setting the input saturation.
PL.INTOUTMAX (→ P. 630)	NV	Limits the output of the position loop integrator by setting the output saturation.
PL.KI (→ P. 632)	NV	Sets the integral gain of the position loop.

Parameter or Command	Type	Description
PL.KP (→ P. 633)	NV	Sets the proportional gain of the position regulator PID loop.
PL.MODP1	R/W	Sets modulo range parameter.
PL.MODP2	R/W	Sets the beginning or end modulo range parameter.
PL.MODPDIR	R/W	Sets the direction for absolute motion tasks.
PL.MODPEN	R/W	Enables the modulo position.
PL.PDELAY (→ p. 634)	R/W	Sets the delay time for PL.CMD.
Recorder (REC)		
REC.ACTIVE (→ P. 636)	R/O	Indicates if data recording is in progress (active).
REC.CH1 to REC.CH6 (→ p. 637)	R/W	Sets recording channels 1 to 6.
REC.DONE (→ P. 638)	R/O	Checks whether or not the recorder has finished recording.
REC.GAP (→ P. 639)	R/W	Specifies the gap between consecutive samples.
REC.NUMPOINTS (→ P. 640)	R/W	Sets the number of points to record.
REC.OFF (→ P. 641)	R/W	Turns the recorder OFF.
REC.RECPRMLIST (→ p. 642)	R/O	Reads the list of recordable parameters.
REC.RETRIEVE (→ P. 643)	R/O	Transfers all the recorded data to the communication channel.
REC.RETRIEVEDATA (→ p. 644)	R/W	Retrieves the recorded data without the header.
REC.RETRIEVEFRMT (→ p. 646)	R/W	Sets the format for recorded data output.
REC.RETRIEVEHDR (→ p. 647)	R/O	Retrieves the recorded header without the data.
REC.RETRIEVESIZE (→ p. 648)	R/W	Sets the number of samples that REC.RETRIEVEDATA returns.
REC.STOPTYPE (→ p. 649)	R/W	Sets the recorder stop type.
REC.TRIG (→ P. 650)	Command	Triggers the recorder.
REC.TRIGPARAM (→ p. 651)	R/W	Sets the parameter that triggers the recorder.
REC.TRIGPOS (→ p. 652)	R/W	Sets the trigger position in the recording buffer.
REC.TRIGPRMLIST (→ p. 654)	R/O	Reads the list of possible trigger parameters.
REC.TRIGSLOPE (→ P. 655)	R/W	Sets the trigger slope.
REC.TRIGTYPE (→ P. 656)	R/W	Sets the trigger type.
REC.TRIGVAL (→ P. 657)	R/W	Sets the trigger value.
Regen Resistor (REGEN)		
REGEN.POWER (→ P. 659)	R/O	Reads regen resistor's calculated power.
REGEN.POWERFILTERED (→ p. 660)	R/O	Returns a filtered version of REGEN.POWER .
REGEN.REXT (→ P. 661)	N/V	Sets the external, user-defined regen resistor resistance.
REGEN.TEXT (→ p. 662)	R/W	Sets the external regen resistor thermal protection time constant.
REGEN.TYPE (→ P. 663)	NV	Sets the regen resistor type.

Parameter or Command	Type	Description
REGEN.WATTEXT (→ P. 664)	R/W	Sets the regen resistor's power fault level for an external regen resistor.
Service Motion (SM)		
SM.ACC (→ p. 666)	NV	Sets the acceleration ramp for service motion if set to greater than 0.
SM.DEC (→ p. 667)	NV	Sets the deceleration ramp for service motion if set to greater than 0.
SM.I1 (→ p. 668)	R/W	Sets service motion current 1; active in opmode 0 (torque) only.
SM.I2 (→ p. 669)	R/W	Sets service motion current 2; active in opmode 0 (torque) only.
SM.MODE (→ p. 670)	R/W	Sets the service motion mode.
SM.MOVE (→ p. 673)	Command	Starts the service motion.
SM.T1 (→ p. 674)	R/W	Sets the service motion time 1.
SM.T2 (→ p. 675)	R/W	Sets the service motion time 2.
SM.V1 (→ p. 676)	R/W	Sets service motion velocity 1; active in opmode 1 (velocity) and 2 (position).
SM.V2 (→ p. 677)	R/W	Sets service motion velocity 2; active in opmode 1 (velocity) and 2 (position).
Safe Torque Off (STO)		
STO.STATE (→ p. 679)	R/O	Returns the status of the safe torque off.
Software Limit Switch(SWLS)		
SWLS.EN (→ p. 681)	NV	Enables and disables software travel limit switches.
SWLS.LIMIT0 (→ p. 682)	NV	Sets the position of the software travel limit switch 0.
SWLS.LIMIT1 (→ p. 683)	NV	Sets the position of the software travel limit switch 0.
SWLS.STATE (→ p. 684)	R/O	Reads the actual status of software limit switches.
Temperature (TEMP)		
TEMP.CONTROL (→ p. 686)	R/O	Reads the temperature of the control board temperature sensor.
TEMP.POWER1 to TEMP.POWER3 (→ p. 687)	R/O	Reads the temperature of the power board(s) temperature sensor(s).
User (USER)		
USER.INT1 to USER.INT24 (→ p. 689)	R/W	Stores an integer value for future reference.
Bus Volatage (VBUS)		
VBUS.HALFVOLT (→ p. 691)	NV	Changes voltage thresholds for -07 drives.
VBUS.OVFTHRESH (→ p. 692)	R/O	Reads the over voltage fault level.
VBUS.OVWTHRESH (→ p. 693)	N/V	Sets voltage level for over voltage warning.
VBUS.RMSLIMIT (→ p. 694)	R/O	Reads the limit for the bus capacitors load.
VBUS.UVFTHRESH (→ p. 695)	R/O	Sets the under voltage fault level.
VBUS.UVMODE (→ p. 696)	NV	Indicates undervoltage (UV) mode.

Parameter or Command	Type	Description
VBUS.UVWTHRESH (→ p. 697)	NV	Sets voltage level for undervoltage warning.
VBUS.VALUE (→ p. 698)	R/O	Reads DC bus voltage.
Velocity Loop (VL)		
VL.ARPF1 TO VL.ARPF4 (→ p. 700)	R/W	Sets the natural frequency of the pole (denominator) of anti-resonance (AR) filters 1, 2, 3, and 4; active in opmodes 1 (velocity) and 2 (position) only.
VL.ARPQ1 TO VL.ARPQ4 (→ p. 702)	R/W	Sets the Q of the pole (denominator) of anti-resonance (AR) filter 1; active in opmodes 1 (velocity) and 2 (position) only.
VL.ARTYPE1 TO VL.ARTYPE4 (→ p. 704)	NV	Indicates the method used to calculate BiQuad coefficients; active in opmodes 1 (velocity) and 2 (position) only.
VL.ARZF1 TO VL.ARZF4 (→ p. 705)	R/W	Sets the natural frequency of the zero (numerator) of anti-resonance (AR) filter 1; active in opmodes 1 (velocity) and 2 (position) only.
VL.ARZQ1 TO VL.ARZQ4 (→ p. 706)	R/W	Sets the Q of the zero (numerator) of anti-resonance filter #1; active in opmodes 1 (velocity) and 2 (position) only.
VL.BUSFF (→ p. 707)	R/O	Displays the velocity loop feedforward value injected by the field-bus; active in opmodes 1 (velocity) and 2 (position) only.
VL.CMD (→ P. 708)	R/O	Reads the actual velocity command; active in opmodes 1 (velocity) and 2 (position) only.
VL.CMDU (→ P. 709)	R/W	Sets the user velocity command; active in opmodes 1 (velocity) and 2 (position) only.
VL.ERR (→ P. 710)	R/O	Sets the velocity error; active in opmodes 1 (velocity) and 2 (position) only.
VL.FB (→ P. 711)	R/O	Reads the velocity feedback; active in opmodes 1 (velocity) and 2 (position) only.
VL.FBFILTER (→ p. 712)	R/O	Filters VL.FB (→ p. 711) value; active in opmodes 1 (velocity) and 2 (position) only.
VL.FBSOURCE (→ p. 713)	NV	Sets feedback source for the velocity loop; active in opmodes 1 (velocity) and 2 (position) only.
VL.FBUNFILTERED (→ p. 714)	R/O	Reads the velocity feedback.
VL.FF (→ p. 715)	R/O	Displays the velocity loop overall feedforward value; active in opmodes 1 (velocity) and 2 (position) only.
VL.FFDELAY (→ p. 716)	R/W	Sets the delay time for the velocity feedforward integrator component.
VL.GENMODE (→ P. 717)	NV	Selects mode of velocity generation (Observer, d/dt); active in opmodes 1 (velocity) and 2 (position) only.
VL.KBUSFF (→ p. 718)	R/W	Sets the velocity loop acceleration feedforward gain value; active in opmodes 1 (velocity) and 2 (position) only.
VL.KI (→ p. 719)	NV	Sets the velocity loop integral gain for the PI controller; active in opmodes 1 (velocity) and 2 (position) only.
VL.KP (→ p. 721)	NV	Sets velocity loop proportional gain for the PI controller; active in opmodes 1 (velocity) and 2 (position) only.

Parameter or Command	Type	Description
VL.KVFF (→ p. 723)	R/W	Sets the velocity loop velocity feedforward gain value; active in opmodes 1 (velocity) and 2 (position) only.
VL.LIMITN (→ P. 724)	NV	Sets the velocity lower limit; active in opmodes 1 (velocity) and 2 (position) only.
VL.LIMITP (→ P. 726)	NV	Sets the velocity high limit; active in opmodes 1 (velocity) and 2 (position) only.
VL.LMJR (→ p. 727)	R/W	Sets the ratio of the estimated load moment of inertia relative to the motor moment of inertia; active in opmodes 1 (velocity) and 2 (position) only.
VL.MODEL (→ p. 728)	R/O	Reads the observer velocity signal; active in opmodes 1 (velocity) and 2 (position) only.
VL.OBSBW (→ p. 729)	NV	Sets the bandwidth of the observer in Hz.
VL.OBSMODE (→ p. 730)	NV	Sets the observer operating mode.
VL.THRESH (→ P. 731)	NV	Sets the user over speed fault level.
VL.VFTHRESH (→ p. 733)	R/O	VL.VFTHRESH
Wake and Shake (WS)		
WS.ARM (→ p. 735)	Command	Sets wake and shake to start at the next drive enable.
WS.CHECKMODE (→ p. 736)	R/W	Select the type of commutation check to execute after Wake and Shake finds a new commutation angle.
WS.CHECKT (→ p. 737)	R/W	Sets the amount of time a communication error must be present before an error is thrown.
WS.CHECKV (→ p. 738)	R/W	This parameter sets the velocity threshold which has to be exceeded to activate commutation monitoring.
WS.DISARM (→ p. 739)	Command	Cancels ARM requests and resets wake and shake to the IDLE state.
WS.DISTMAX (→ p. 740)	R/W	Sets maximum movement allowed for wake and shake.
WS.DISTMIN (→ p. 741)	R/W	Sets the minimum movement required for wake and shake.
WS.FREQ (→ p. 742)	R/W	Sets the sine frequency of excitation for WS.MODE 2.
WS.IMAX (→ p. 743)	R/W	Sets maximum current used for wake and shake.
WS.MODE (→ p. 744)	R/W	Sets the method used for wake and shake.
WS.NUMLOOPS (→ p. 745)	R/W	Sets the number of repetitions for wake and shake.
WS.STATE (→ p. 746)	R/O	Reads wake and shake status.
WS.T (→ p. 747)	R/W	Sets wake and shake current-vector appliance time.
WS.TDELAY1 (→ p. 748)	NV	Delay for wake and shake timing.
WS.TDELAY2 (→ p. 749)	NV	Sets the delay for wake and shake timing.
WS.TDELAY3 (→ p. 750)	NV	Sets the delay for wake and shake between loops in mode 0.
WS.TDELAY4 (→ p. 751)	NV	Sets the delay time after first current-pulse injection.
WS.TIRAMP (→ p. 752)	R/W	Sets the ramp time for the ramp up current in Wake & Shake mode 1.
WS.TSTANDSTILL (→ p. 753)	R/W	Sets the calming time of the motor for Wake & Shake mode 1.

Parameter or Command	Type	Description
WS.VTHRESH (→ p. 754)	NV	Defines the maximum allowed velocity for Wake & Shake.

19.2 AOUT Parameters

This section describes the AOUT parameters.

19.2.1 AOUT.CUTOFF	261
19.2.2 AOUT.DEBUGADDR	262
19.2.3 AOUT.DEBUGDATATYPE	263
19.2.4 AOUT.DEBUGSCALE	264
19.2.5 AOUT.ISCALE	265
19.2.6 AOUT.MODE	266
19.2.7 AOUT.OFFSET	267
19.2.8 AOUT.PSCALE	268
19.2.9 AOUT.VALUE	269
19.2.10 AOUT.VALUEU	270
19.2.11 AOUT.VSCALE	271

19.2.1 AOUT.CUTOFF

General Information	
Type	NV Parameter
Description	Sets the analog output low-pass filter cutoff frequency.
Units	Hz
Range	0 to 10,000 Hz
Default Value	0 Hz
Data Type	Float
Start Version	M_01-04-01

Fieldbus Information

Description

AOUT.CUTOFF sets the cutoff frequency in Hz for a single-pole low-pass filter on the Analog Output.

A value of 0 Hz will turn off the filter and will allow all frequencies to pass through.

The filter can be used with all modes of Analog Output.

Related Topics

Analog Output (pg 1)

19.2.2 AOUT.DEBUGADDR

General Information	
Type	NV Parameter
Description	Sets the memory address to debug.
Units	N/A
Range	4 to 4,292,870,142
Default Value	4
Data Type	Integer
Start Version	M_01-01-01-000

Description

AOUT.DEBUGADDR sets the memory address to debug when AOUT.MODE (→ p. 266) = 9 (debug mode).

Related Topics

1 Analog Output

AOUT.MODE (→ p. 266)

19.2.3 AOUT.DEBUGDATATYPE

General Information	
Type	NV Parameter
Description	Sets the data type of the value to be debugged.
Units	N/A
Range	0 to 10
Default Value	0
Data Type	Integer
Start Version	M_01-01-01-000

Description

AOUT.DEBUGDATATYPE is used in AOUT.MODE (→ p. 266) = 9 (debug mode).

This parameter sets the data type of the value to be debugged according to the table below:

Value	Data Type
0	Illegal type
1	Signed (1 byte)
2	Unsigned (1 byte)
3	Signed (2 bytes)
4	Unsigned (2 bytes)
5	Signed (4 bytes)
6	Unsigned (4 bytes)
7	Signed (8 bytes)
8	Unsigned (8 bytes)
9	Pointer to one byte
10	Fix shift

Related Topics

- 1 Analog Output

19.2.4 AOUT.DEBUGSCALE

General Information	
Type	NV Parameter
Description	Sets the scale to be used for debug.
Units	N/A
Range	0.001 to 9,223,372,036,854,775.000
Default Value	1
Data Type	Float
Start Version	M_01-01-01-000

Description

AOUT.DEBUGSCALE sets the scale to be used for debug when AOUT.MODE (→ p. 266) = 9 (debug mode).

Related Topics

1 Analog Output

AOUT.MODE (→ p. 266)

19.2.5 AOUT.ISCALE

General Information	
Type	NV Parameter
Description	Sets the analog current scale factor.
Units	A/V
Range	0.001 to 22.4 A/V
Default Value	0.001 to 22.4 A/V
Data Type	Float
Start Version	M_01-01-01-000

Fieldbus Information

Fieldbus	Index/Subindex	Object Start Version
EtherCAT COE and CANopen	5009h/0	M_01-00-00-000

Description

AOUT.ISCALE sets the analog current scale factor that scales the analog output (AOUT.VALUE) for AOUT.MODE = 4 or 5. The value entered is the motor current per 10 V of analog input or output. This value may be either higher or lower than 100%, but the actual analog I/O will be limited by the application current limit (IL.LIMITN (→ p. 551) and IL.LIMITP (→ p. 552)).

Related Topics

Analog Output (pg 1)

AOUT.ISCALE (→ p. 1)

19.2.6 AOUT.MODE

General Information	
Type	NV Parameter
Description	Sets the analog output mode.
Units	N/A
Range	0 to 11
Default Value	0
Data Type	Integer
Start Version	M_01-00-00-000

Fieldbus Information

Fieldbus	Index/Subindex	Object Start Version
EtherCAT COE and CANopen	3470h/1	M_01-00-00-000

Description

AOUT.MODE sets the analog output functionality.

AOUT.MODE	Description
0	User variable. The analog output signal is determined by the user (using AOUT.VALUEU).
1	Actual velocity. The analog signal describes the current velocity value (VL.FB).
2	Velocity error. The analog signal describes the velocity error value.
3	Velocity command. The analog signal describes the velocity command value.
4	Actual current. The analog signal describes the actual current value.
5	Current command. The analog signal describes the current command value.
6	Actual position. The analog signal describes the current position value.
7	Position error. The analog signal describes the position error value.
8	Triangle wave. The analog signal is a triangle wave (sawtooth pattern).
9	Debug mode. In this mode the user can define a drive variable to monitor via the analog output (AOUT.VALUEU).
10	Unfiltered Velocity (VL.FBUNFILTERED)
11	Filtered Velocity - 10Hz Lowpass (VL.FBFILTER)

Example

You can use AOUT.MODE and AOUT.VALUEU to configure an output signal as follows:

```
-->AOUT.MODE 0
-->AOUT.VALUEU 5
-->AOUT.VALUEU 4.33
```

Related Topics

Analog Output (pg 1)

19.2.7 AOUT.OFFSET

General Information	
Type	NV Parameter
Description	Sets the analog output offset.
Units	V
Range	-10 to +10 V
Default Value	0 V
Data Type	Float
Start Version	M_01-00-00-000

Fieldbus Information

Fieldbus	Index/Subindex	Object Start Version
EtherCAT COE and CANopen	500Bh/0	M_01-00-00-000

Description

This parameter sets the analog output offset.

Related Topics

Analog Output (pg 1)

19.2.8 AOUT.PSCALE

General Information	
Type	NV Parameter
Description	Sets the analog position scale factor.
Units	Rotary: counts/V, rad/V, deg/V, 16-bit counts/V Linear: counts/V, mm/V, $\mu\text{m}/\text{V}$, 16-bit counts/V
Range	Rotary: 1 to 9,223,372,036,854,775 counts/V 0 to 13,493,026.816 rad/V 0 to 773,094,113.280 deg/V 0 to 140,737,488,355.327 16-bit counts/V Linear: 1 to 9,223,372,036,854,775 counts/V 0 to 2,147,483.648 mm/V 0 to 2,147,483,648.000 $\mu\text{m}/\text{V}$ 0 to 140,737,488,355.327 16-bit counts/V
Default Value	Rotary: 1 counts/V 0 rad/V 0 deg/V 0 16-bit counts/V Linear: 1 counts/V 0 rad/V 0 deg/V 0 counts 16 bit/V
Data Type	Float
Start Version	M_01-01-01-000

Fieldbus Information

Fieldbus	Index/Subindex	Object Start Version
EtherCAT COE and CANopen	3471h/0	M_01-00-00-000

Description

AOUT.PSCALE is an analog position scale factor that scales the analog output (AOUT.VALUE (→ p. 269)) for AOUT.MODE (→ p. 266) = 6, or 7 (actual position or position error) per 10 V of analog input or output.

Related Topics

Analog Output (pg 1)

AOUT.VALUE (→ p. 269)

19.2.9 AOUT.VALUE

General Information	
Type	R/O Parameter
Description	Reads the analog output value.
Units	V
Range	-10 to +10 V
Default Value	0
Data Type	Float
Start Version	M_01-00-00-000

Fieldbus Information

Fieldbus	Index/Subindex	Object Start Version
EtherCAT COE and CANopen	3470h/2	M_01-00-00-000

Description

AOUT.VALUE reads the analog output value.

Related Topics

Analog Output (pg 1)

19.2.10 AOUT.VALUEU

General Information	
Type	R/W Parameter
Description	Sets the analog output value.
Units	V
Range	-10 to +10 V
Default Value	0
Data Type	Float
Start Version	M_01-00-00-000

Fieldbus Information

Fieldbus	Index/Subindex	Object Start Version
EtherCAT COE and CANopen	3470h/3	M_01-00-00-000

Description

AOUT.VALUEU reads/writes the analog output value when AOUT.MODE (→ p. 266) = 0 (analog output signal is determined by the user).

Related Topics

Analog Output (pg 1)

19.2.11 AOUT.VSCALE

General Information	
Type	NV Parameter
Description	Sets the velocity scale factor for analog output.
Units	Depends on UNIT.VROTARY or UNIT.ACCLINEAR Rotary: rpm/V, rps/V, (deg/s)/V, [(custom units)/s]/V, (rad/s)/V Linear: counts/s/V, (mm/s)/V, (μm/s)/V, [(custom units)/s]/V
Range	Rotary: 0.060 to 60,000 rpm/V 0.001 to 1,000 rps/V 0.359 to 360,000 (deg/s)/V 0.005 to 5,000 [(custom units)/s]/V 0.006 to 6,283.186 (rad/s)/V Linear: 0.001 to 1,000 counts/s/V 0.001*MOTOR.PITCH to 1,000,000*MOTOR.PITCH (mm/s)/V 0.998*MOTOR.PITCH to 1,000,000,000*MOTOR.PITCH(μm/s)/V 0.005 to 5,000 [(custom units)/s]/V
Default Value	Rotary: 0.060 rpm/V 0.001 rps/V 0.359 (deg/s)/V 0.005 [(custom units)/s]/V 0.006 (rad/s)/V Linear: 0.001 counts/s/V 0.001*MOTOR.PITCH (mm/s)/V 0.998*MOTOR.PITCH (μm/s)/V 0.005 [(custom units)/s]/V
Data Type	Float
Start Version	M_01-00-00-000

Variants Supported

Fieldbus Information

Fieldbus	Index/Subindex	Object Start Version
EtherCAT COE and CANopen	3470h/5	M_01-00-00-000

Description

AOUT.VSCALE is an analog velocity scale factor that scales the analog output (AOUT.VALUE) for AOUT.MODE = 1, 2, or 3. The value entered is the motor velocity per 10 V of analog output. This value may be either higher or lower than the application velocity limit (VL.LIMITP or VL.LIMITN), but the actual analog I/O will be limited by VL.LIMITP or VL.LIMITN.

Related Topics

Analog Output (pg 1)

AOUT.VALUE (→ p. 269)

19.3 AOUT2 Parameters

This section describes the AOUT2 parameters.

19.3.1 AOUT2.CUTOFF	273
19.3.2 AOUT2.MODE	274
19.3.3 AOUT2.OFFSET	275
19.3.4 AOUT2.VALUE	276
19.3.5 AOUT2.VALUEU	277

19.3.1 AOUT2.CUTOFF

General Information	
Type	NV Parameter
Description	Sets the analog output 2 low-pass filter cutoff frequency.
Units	Hz
Range	0 to 10,000 Hz
Default Value	0 Hz
Data Type	Float
Start Version	M_01-06-03-000

Description

AOUT2.CUTOFF sets the cutoff frequency in Hz for a single-pole low-pass filter on the Analog Output 2.

A value of 0 Hz will turn off the filter and will allow all frequencies to pass through.

The filter can be used with all modes of Analog Output 2.

Related Topics

- 1 Analog Output

19.3.2 AOUT2.MODE

General Information	
Type	NV Parameter
Description	Sets the analog output 2 mode.
Units	N/A
Range	0
Default Value	0
Data Type	Integer
Start Version	M_01-06-03-000

Description

AOUT2.MODE sets the analog output functionality.

Mode 0: User variable. The analog output 2 signal is determined by the user (using AOUT2.VALUEU (→ p. 277)).

Example

You can use AOUT.MODE and AOUT.VALUEU to configure an output signal as follows:

```
-->AOUT.MODE 0
-->AOUT.VALUEU 5
-->AOUT.VALUEU 4.33
```

Related Topics

- 1 Analog Output

19.3.3 AOUT2.OFFSET

General Information	
Type	NV Parameter
Description	Sets the analog output 2 offset.
Units	V
Range	-10 to +10 V
Default Value	0 V
Data Type	Float
Start Version	M_01-06-03-000

Description

This parameter sets the analog output 2 offset.

Related Topics

- 1 Analog Output

19.3.4 AOUT2.VALUE

General Information	
Type	R/O Parameter
Description	Reads the analog output 2 value.
Units	V
Range	-10 to +10 V
Default Value	0
Data Type	Float
Start Version	M_01-06-03-000

Description

AOUT2.VALUE reads the analog output 2 value.

Related Topics

- 1 Analog Output

19.3.5 AOUT2.VALUEU

General Information	
Type	R/W Parameter
Description	Sets the analog output 2 value.
Units	V
Range	-10 to +10 V
Default Value	0
Data Type	Float
Start Version	M_01-06-03-000

Description

AOUT2.VALUEU reads/writes the analog output 2 value when AOUT2.MODE (→ p. 274) = 0 (analog output signal is determined by the user).

Related Topics

- 1 Analog Output

19.4 BODE Parameters

This section describes the BODE parameters.

19.4.1 BODE.EXCITEGAP	279
19.4.2 BODE.FREQ	280
19.4.3 BODE.IAMP	281
19.4.4 BODE.IFLIMIT	282
19.4.5 BODE.IFTHRESH	283
19.4.6 BODE.INJECTPOINT	284
19.4.7 BODE.MODE	285
19.4.8 BODE.MODETIMER	288
19.4.9 BODE.PRBDEPTH	290
19.4.10 BODE.VAMP	291
19.4.11 BODE.VFLIMIT	292
19.4.12 BODE.VFTHRESH	293

19.4.1 BODE.EXCITEGAP

General Information	
Type	R/W Parameter
Description	Controls how often the excitation is updated.
Units	Drive samples
Range	1 to 255 drive samples
Default Value	2 drive samples
Data Type	N/A
Start Version	M_01-00-00-000

Fieldbus	Index/Subindex	Object Start Version
EtherCAT COE and CANopen	5013h/0	M_01-00-00-000

Description

BODE.EXCITEGAP controls how often the excitation is updated. The excitation is updated every n drive samples, where n is BODE.EXCITEGAP. For example, if BODE.EXCITEGAP = 2, then the excitation is updated every $2/(16,000 \text{ Hz}) = 1/8,000 \text{ Hz} = 0.000125 \text{ sec}$. When measuring a system, update the excitation only as often as the data is recorded.

Example

Set excitation update rate to 8,000 Hz:

```
-->BODE.EXCITEGAP 2
```

Set excitation update rate to 4,000 Hz:

```
-->BODE.EXCITEGAP 4
```

Get excitation update rate (already set to 8000 Hz):

```
-->BODE.EXCITEGAP 2
```

Related Topics

Using the Performance Servo Tuner (→ p. 106) | Using the Performance Servo Tuner: Advanced (→ p. 110)

Scope (→ p. 153)

Settings (→ p. 39)

F126 (→ p. 175)

Error: Invalid Bode plot mode for this function. (→ p. 197)

19.4.2 BODE.FREQ

General Information	
Type	R/W Parameter
Description	Sets the frequency of the sine excitation source.
Units	Hz
Range	0 to 8,000 Hz
Default Value	0 Hz
Data Type	Float
Start Version	M_01-00-00-000

Description

BODE.FREQ sets the frequency of the sine excitation source in Hz. The sine excitation source is used to take frequency response measurements of a system.

Example

Setting up a sine excitation source of 0.2 A at 50 Hz:

```
-->BODE.INJECTPOINT 1
-->BODE.IAMP 0.2
-->BODE.FREQ 50.0
-->BODE.MODE 2
```

Related Topics

Using the Performance Servo Tuner (→ p. 106)

Using the Performance Servo Tuner: Advanced (→ p. 110)

Scope (→ p. 153)

Settings (→ p. 39)

F126 (→ p. 175)

Error: Invalid Bode plot mode for this function. (→ p. 197)

BODE.MODE (→ p. 285)

BODE.INJECTPOINT (→ p. 284)

BODE.VAMP (→ p. 291)

BODE.IAMP (→ p. 281)

19.4.3 BODE.IAMP

General Information	
Type	R/W Parameter
Description	Sets current command value used during the Bode procedure.
Units	A
Range	+/- Combined drive and motor current limit
Default Value	0.2 A
Data Type	Float
Start Version	M_01-00-00-000

Fieldbus	Index/Subindex	Object Start Version
EtherCAT COE and CANopen	5015h/0	M_01-00-00-000

Description

BODE.IAMP sets the amplitude of the excitation when in current mode as set in BODE.INJECTPOINT. When using BODE.MODE (→ p. 285) = 1 and BODE.INJECTPOINT (→ p. 284) = 1, this parameter will determine the level of noise injected to commanded current value.

Example

Set the excitation current to 0.2 A:

```
-->BODE.IAMP 0.2
```

Get the excitation current (already set to 0.2 A):

```
-->BODE.IAMP 0.200 [A]
```

Related Topics

Using the Performance Servo Tuner (→ p. 106)

Using the Performance Servo Tuner: Advanced (→ p. 110)

Scope (→ p. 153)

Settings (→ p. 39)

F126 (→ p. 175)

Error: Invalid Bode plot mode for this function. (→ p. 197)

BODE.INJECTPOINT (→ p. 284) | BODE.FREQ (→ p. 280)

19.4.4 BODE.IFLIMIT

General Information	
Type	R/W Parameter
Description	Sets the current fault duration limit in seconds for the BODE.MODE 5 stability test.
Units	s
Range	0.001 to 60.000
Default Value	0
Data Type	Decimal
Start Version	M_01-02-10-000

Description

When BODE.MODE is set to 5, the firmware monitors the drive current (IL.CMD (→ p. 527)). When IL.CMD goes above BODE.IFTHRESH (→ p. 283), an internal counter records the length of time IL.CMD was above BODE.IFTHRESH. If the internal counter reaches BODE.IFLIMIT, Fault 133 – Instability during Autotune will be generated.

The smaller BODE.IFLIMIT, the quicker Fault 133 will be generated when IL.CMD exceeds BODE.IFLIMIT.

Example

Set BODE.IFTHRESH to 6 Amps:

```
-->BODE.IFTHRESH 6
```

Set BODE.IFLIMIT to 0.500 seconds:

```
-->BODE.IFLIMIT 0.5
```

Set BODE.MODE to 5 to enable stability detection:

```
BODE.MODE 5
```

Related Topics

Using the Performance Servo Tuner (→ p. 106)

Using the Performance Servo Tuner: Advanced (→ p. 110)

F133 (→ p. 176)

BODE.MODE (→ p. 285), BODE.MODETIMER (→ p. 288), BODE.IFTHRESH (→ p. 283), BODE.VFLIMIT (→ p. 292), BODE.VFTHRESH (→ p. 293)

19.4.5 BODE.IFTHRESH

General Information	
Type	R/W Parameter
Description	Sets the current fault threshold for the BODE.MODE 5 stability test.
Units	A
Range	0.001 to DRV.IPEAK or MOTOR.IPEAK (whichever is lowest) A
Default Value	0 A
Data Type	Decimal
Start Version	M_01-02-10-000

Description

When BODE.MODE (→ p. 285) is set to 5, the firmware monitors the drive current (IL.CMD (→ p. 527)). When IL.CMD goes above BODE.IFTHRESH, an internal counter records the length of time IL.CMD was above BODE.IFTHRESH. If the internal counter reaches BODE.IFLIMIT (→ p. 282), Fault 133 (Instability during Autotune) is generated.

Example

Set BODE.IFTHRESH to 6 Amps:

```
-->BODE.IFTHRESH 6
```

Set BODE.IFLIMIT to 0.500 seconds:

```
-->BODE.IFLIMIT 0.5
```

Set BODE.MODE to 5 to enable stability detection:

```
BODE.MODE 5
```

Related Topics

Using the Performance Servo Tuner (→ p. 106)

Using the Performance Servo Tuner: Advanced (→ p. 110)

F133 (→ p. 176)

BODE.MODE (→ p. 285), BODE.MODETIMER (→ p. 288), BODE.VFLIMIT (→ p. 292), BODE.VFTHRESH (→ p. 293), BODE.IFLIMIT (→ p. 282)

19.4.6 BODE.INJECTPOINT

General Information	
Type	R/W Parameter
Description	Sets whether the excitation uses current or velocity excitation type.
Units	N/A
Range	0 to 2
Default Value	0
Data Type	Integer
Start Version	M_01-00-00-000

Fieldbus	Index/Subindex	Object Start Version
EtherCAT COE and CANopen	5016h/0	M_01-00-00-000

Description

BODE.INJECTPOINT sets whether the excitation uses current or velocity excitation type.

BODE.INJECTPOINT	Description
0	None
1	Current
2	Velocity

Example

Set BODE.INJECTPOINT to current:

```
-->BODE.INJECTPOINT 1
```

Get BODE.INJECTPOINT (already set to current):

```
-->BODE.INJECTPOINT 1
```

Related Topics

Using the Performance Servo Tuner (→ p. 106)

Using the Performance Servo Tuner: Advanced (→ p. 110)

Scope (→ p. 153)

Settings (→ p. 39)

F126 (→ p. 175)

Error: Invalid Bode plot mode for this function. (→ p. 197)

BODE.IAMP (→ p. 281), BODE.MODE (→ p. 285), BODE.VAMP (→ p. 291)

19.4.7 BODE.MODE

General Information	
Type	R/W Parameter
Description	Sets the mode of the excitation.
Units	N/A
Range	0 to 4
Default Value	0
Data Type	Integer
Start Version	M_01-00-00-000

Description

BODE.MODE sets the mode of the excitation. The excitation can be set to the modes shown in the table below. BODE.MODE is always set to **None** when Ethernet communication is disconnected. The peak amplitude of the excitation is set by either BODE.IAMP or BODE.VAMP (depending on BODE.INJECTPOINT).

BODE.MODE is subject to a watchdog timer (BODE.MODETIMER) as follows:

- If BODE.MODETIMER is 0, then BODE.MODE is not affected.
- If BODE.MODETIMER is set to a value greater than 0, then BODE.MODE will be set to 0 (None) after the BODE.MODETIMER time milliseconds.
- If BODE.MODE is a nonzero value, and you reset BODE.MODE to another nonzero value, you will reset the watchdog timer. This mechanism is intended to turn off the excitation signal if you lose communication with the drive.

BODE.MODE	Description	Comments
0	None	Turns all excitation off
1	PRB	Uses Pseudo Random Binary (PRB) excitation. PRB is a signal that is always +/- peak amplitude, varying only in phase. PRB excitation results in a flat excitation frequency spectrum. PRB results in a high peak excitation amplitude, which can help minimize friction in a frequency response test. PRB excitation repeats every $(2^{BODE.PRBDEPTH}) / BODE.EXCITEGAP$ drive samples. This repetition can be used to reveal the effects of friction.
2	Sine	Uses Sine excitation
3	Noise	Uses random noise excitation. Noise is a random number generator that varies between +/- peak amplitude.
4	Offset	Sets a torque offset equal to BODE.IAMP

Example

Set BODE.MODE to PRB:

```
-->BODE.MODE 1
```

Get BODE.MODE (already set to PRB):

```
-->BODE.MODE 1
```

PRB excitation:

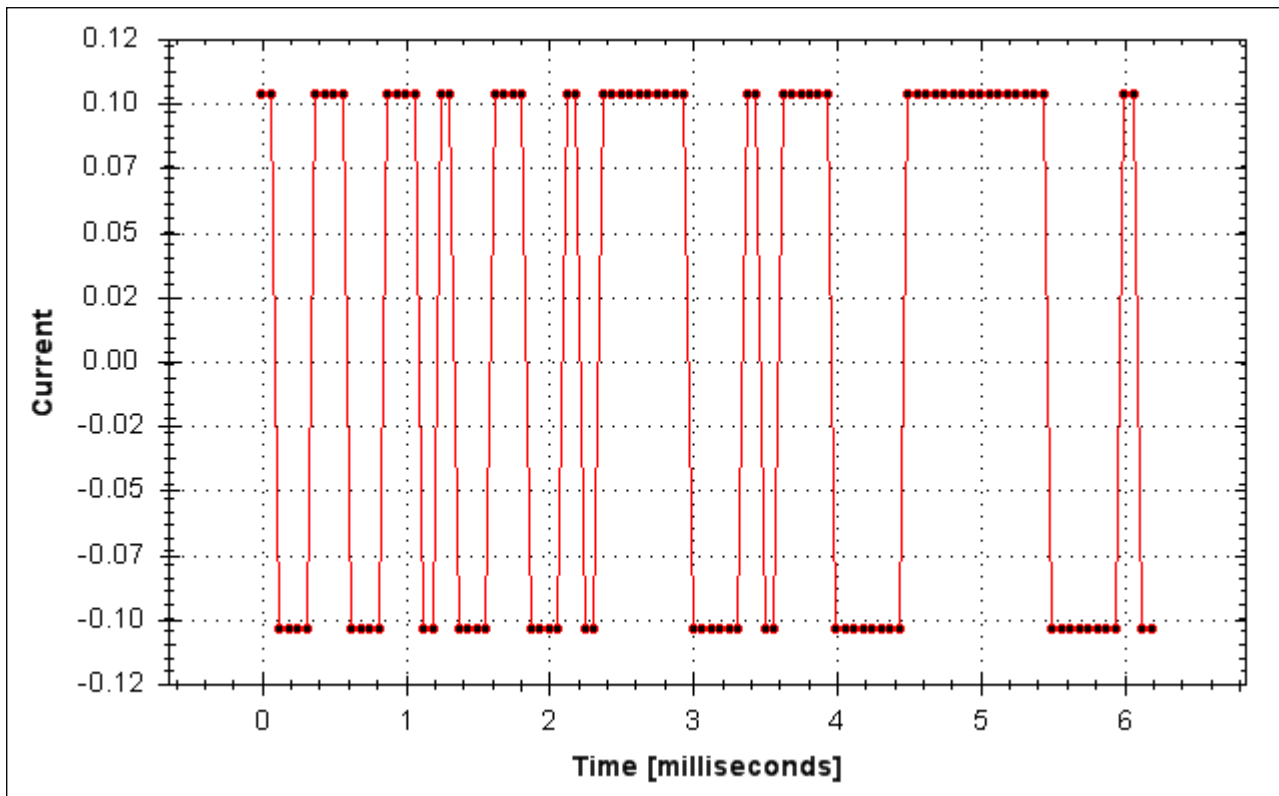

Sine excitation:

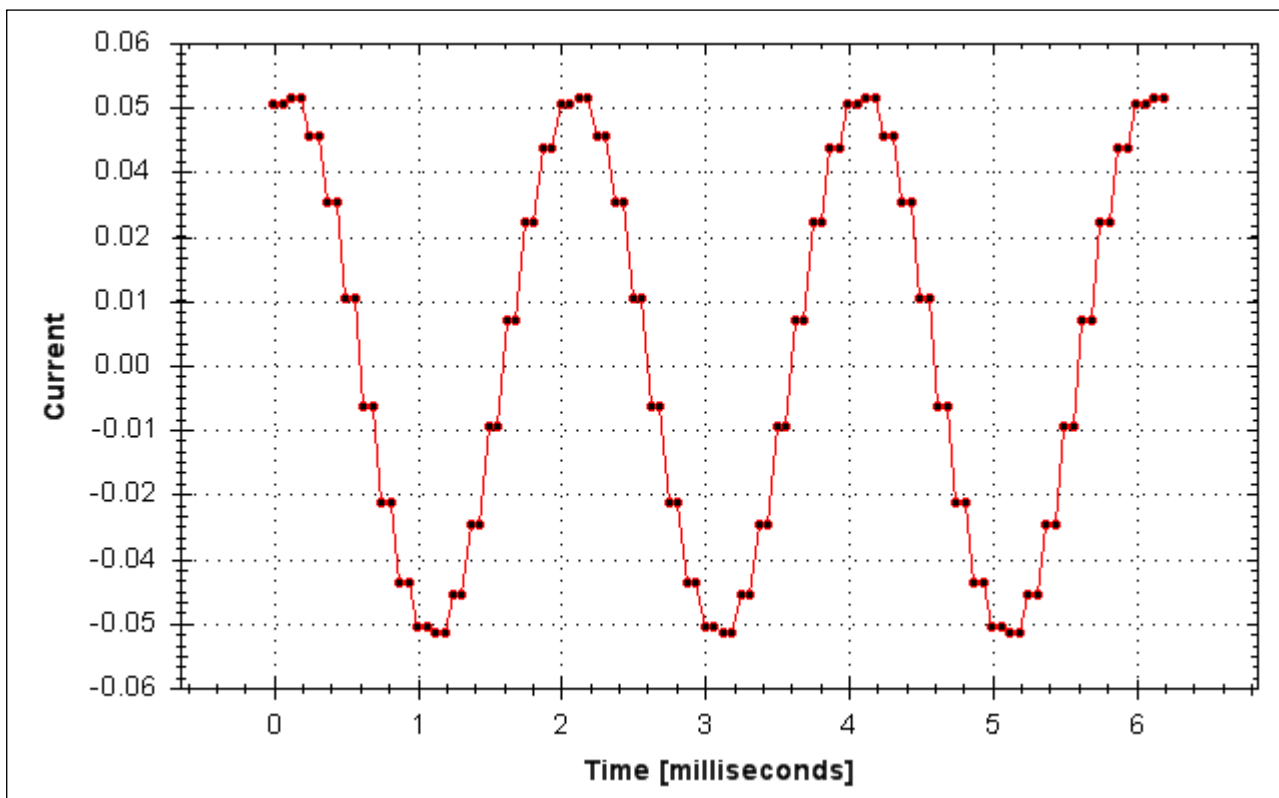

Noise excitation:

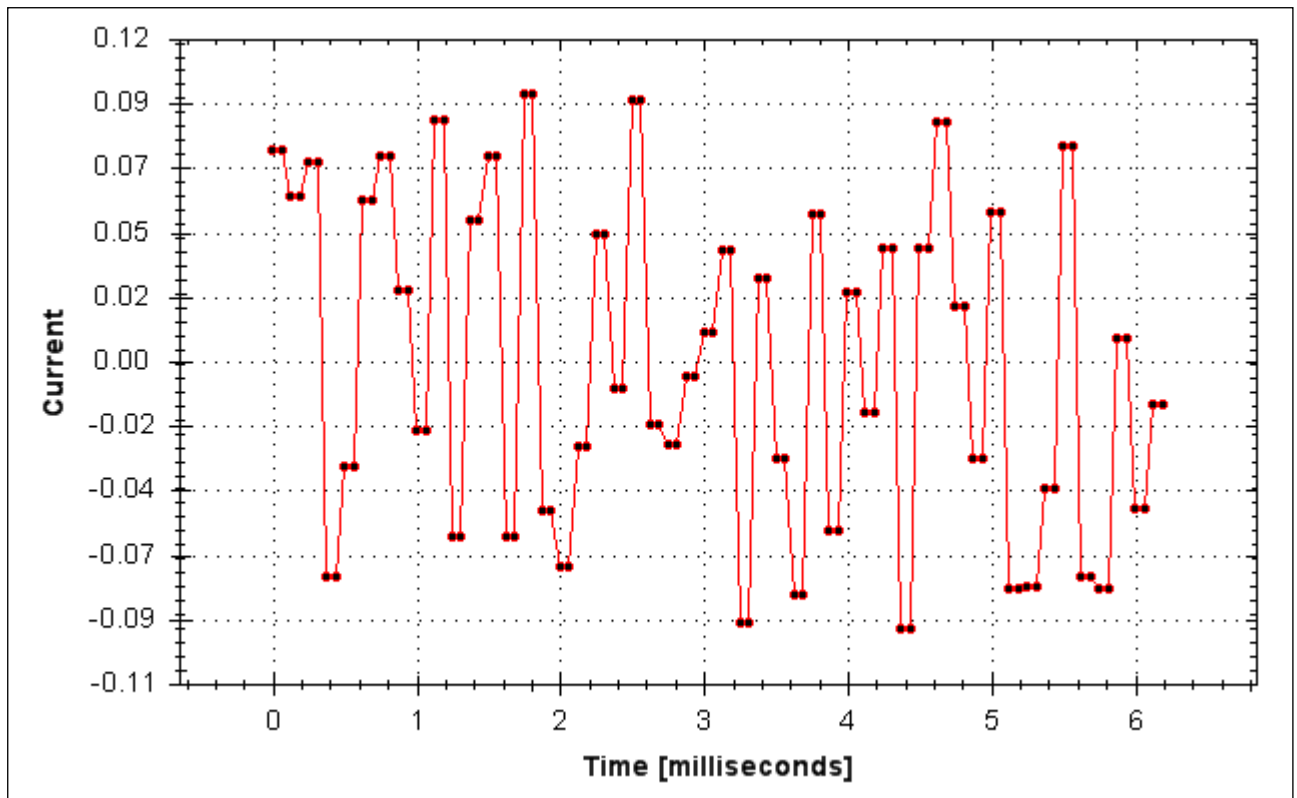

Related Topics

Using the Performance Servo Tuner (→ p. 106)

Using the Performance Servo Tuner: Advanced (→ p. 110)

Scope (→ p. 153)

Settings (→ p. 39)

F126 (→ p. 175)

Error: Invalid Bode plot mode for this function. (→ p. 197)

BODE.INJECTPOINT (→ p. 284) BODE.VAMP (→ p. 291)

19.4.8 BODE.MODETIMER

General Information	
Type	R/W Parameter
Description	Sets the watchdog timer of the excitation.
Units	ms
Range	0 to 268,435,456
Default Value	0
Data Type	Integer
Start Version	M_1-03-00-000

Variants Supported

Fieldbus Information

Description

BODE.MODETIMER sets the watchdog timer for the excitation. This watchdog is used to automatically turn off the excitation of the system if communication is lost. It is highly recommended that you use the watchdog for any excitation measurements. The EWV¹ Performance Servo Tuner and Bode tool automatically use these values, requiring no action from you.

If the BODE.MODETIMER is a nonzero value, the Bode watchdog is enabled. BODE.MODE will be set to 0 (None) after the BODE.MODETIMER value elapses. To reset the watchdog timer, reset BODE.MODE to a nonzero value.

BODE.MODETIMER	Comments
0	BODE.MODE is left at the value you set it to.
> 0	Uses pseudo random binary (PRB) excitation. PRB is a signal that is always +/- peak amplitude, varying only in phase. PRB excitation results in a flat excitation frequency spectrum. PRB also results in a high peak excitation amplitude, which can help minimize friction in a frequency response test. PRB excitation repeats every $(2^{\text{BODE.PRBDPTH}})/\text{BODE.EXCITEGAP}$ drive samples. This repetition can be used to reveal the effects of friction.

Example

Disable BODE.MODETIMER:

```
-->BODE.MODETIMER //
```

Set to 0 to disable the watchdog

```
0
```

```
-->BODE.MODE // Observe starting state of the Bode mode
```

```
0
```

```
-->BODE.MODE 1 // Set Bode mode to PRB
```

```
-->BODE.MODE // Observe Bode mode state is the same after 0.5 seconds
```

```
1
```

¹Embedded Workbench Views

-->BODE.MODE // Observe Bode mode state is the same after 10 seconds

1

Enable BODE.MODETIMER:

-->BODE.MODETIMER 1000 // Set watchdog to 1 second

-->BODE.MODE 1 // Set Bode mode to PRB

-->BODE.MODE // Observe Bode mode state is the same after 0.5 seconds

1

-->BODE.MODE // Observe Bode mode state has been set to zero after 1.0 seconds

0

Enable and reenable BODE.MODETIMER:

-->BODE.MODETIMER 2500 // Set watchdog to 2.5 seconds

-->BODE.MODE 1 // Set Bode mode to PRB

-->BODE.MODE // Observe Bode mode state is the same after 1.5 seconds

1

-->BODE.MODE 1 // Set Bode mode to PRB, resetting the watchdog timer to the original 2.5 second value set above.

-->BODE.MODE // Observe Bode mode state is the same after 3.0 seconds after the original enabling of BODE.MODE 1

-->BODE.MODE // Observe Bode mode state has been set to zero after 4.0 seconds after the original enabling

of BODE.MODE

0

Related Topics

Using the Performance Servo Tuner (→ p. 106)

Using the Performance Servo Tuner: Advanced (→ p. 110)

Scope (→ p. 153)

Settings (→ p. 39)

F126 (→ p. 175)

Error: Invalid Bode plot mode for this function. (→ p. 197)

BODE.MODE (→ p. 285)

19.4.9 BODE.PRBDEPTH

General Information	
Type	R/W Parameter
Description	Sets the length of the PRB signal before it repeats.
Units	NA
Range	4 to 19
Default Value	19
Data Type	Integer
Start Version	M_01-00-00-000

Variants Supported

Fieldbus Information

Fieldbus	Index/Subindex	Object Start Version
EtherCAT COE and CANopen	5019h/0	M_01-00-00-000

Description

BODE.PRBDEPTH sets the length of the PRB signal before it repeats. This applies only when BODE.MODE = PRB. The PRB excitation will repeat after $(2^{\text{BODE.PRBDEPTH}}) / \text{BODE.EXCITEGAP}$ drive samples.

Example

Set BODE.PRBDEPTH to 19:

```
-->BODE.PRBDEPTH 19
```

Get BODE.PRBDEPTH (already set to 19):

```
-->BODE.PRBDEPTH 19
```

Related Topics

Using the Performance Servo Tuner (→ p. 106)

Using the Performance Servo Tuner: Advanced (→ p. 110)

Scope (→ p. 153)

Settings (→ p. 39)

F126 (→ p. 175)

Error: Invalid Bode plot mode for this function. (→ p. 197)

BODE.MODE (→ p. 285), BODE.INJECTPOINT (→ p. 284), BODE.IAMP (→ p. 281), BODE.VAMP (→ p. 291)

19.4.10 BODE.VAMP

General Information	
Type	R/W Parameter
Description	Sets the amplitude of the excitation when in velocity mode.
Units	Rotary: rpm, rps, deg/s, rad/s Linear: counts/s, mm/s, $\mu\text{m/s}$
Range	Rotary: 0.000 to 15,000.000 rpm 0.000 to 250.000 rps 0.000 to 90,000.000 degree/s 0.000 to 1,570.796 rad/s Linear: 0.000 to 1,073,741,824,000.000 counts/s 0.000 to 8,000.000 mm/s 0.000 to 8,000,000.000 $\mu\text{m/s}$
Default Value	0
Data Type	Float
Start Version	M_01-00-00-000

Variants Supported

Fieldbus Information

Description

BODE.VAMP sets the amplitude of the excitation when in velocity mode as set in BODE.INJECTPOINT.

Example

Set the excitation velocity to 100 RPM

```
-->BODE.VAMP 100
```

Get the excitation velocity(already set to 100 RPM)

```
-->BODE.VAMP
```

100.000 [rpm]

Related Topics

Using the Performance Servo Tuner (→ p. 106)

Using the Performance Servo Tuner: Advanced (→ p. 110)

Scope (→ p. 153)

Settings (→ p. 39)

F126 (→ p. 175)

Error: Invalid Bode plot mode for this function. (→ p. 197)

BODE.MODE (→ p. 285), BODE.INJECTPOINT (→ p. 284)

19.4.11 BODE.VFLIMIT

General Information	
Type	R/W Parameter
Description	Sets the velocity fault duration limit (seconds) for the BODE.MODE 5 stability test
Units	s
Range	0.001 to 60.000
Default Value	0
Data Type	Decimal
Start Version	M_01-02-10-000

Variants Supported

Fieldbus Information

Description

When BODE.MODE is set to 5, the firmware monitors the drive feedback velocity VL.FB. When VL.FB goes above BODE.VFTHRESH, an internal counter records the length of time VL.FB was above BODE.VFTHRESH. If the internal counter reaches BODE.VFLIMIT, Fault 133 – Instability during Autotune will be generated.

The smaller BODE.VFLIMIT, the quicker Fault 133 will be generated when VL.FB exceeds BODE.VFLIMIT.

Example

Set BODE.VFTHRESH to 10 RPM:

```
-->BODE.VFTHRESH 10
```

Set BODE.VFLIMIT to 0.500 seconds

```
-->BODE.VFLIMIT 0.5
```

Set BODE.MODE to 5 to enable stability detection

```
-->BODE.MODE 5
```

Related Topics

Using the Performance Servo Tuner (→ p. 106)

Using the Performance Servo Tuner: Advanced (→ p. 110)

F133 (→ p. 176)

BODE.MODE, BODE.MODETIMER, BODE.IFLIMIT, BODE.IFTHRESH, BODE.VFTHRESH

19.4.12 BODE.VFTHRESH

General Information	
Type	R/W Parameter
Description	Sets the current fault threshold for the BODE.MODE 5 stability test.
Units	Rotary: rpm, rps, deg/s, rad/s Linear: counts/s, mm/s, $\mu\text{m/s}$
Range	Rotary: 0.000 to 15,000.000 rpm 0.000 to 250.000 rps 0.000 to 90,000.000 deg/s 0.000 to 1,570.796 rad/s Linear: 0.000 to 1,073,741,824,000.000 counts/s 0.000 to 8,000.000 mm/s 0.000 to 8,000,000.000 $\mu\text{m/s}$ 0.000 to 1,250.000 Custom Units/s
Default Value	0
Data Type	Decimal
Start Version	M_01-02-10-000

Variants Supported

Fieldbus Information

Description

When BODE.MODE is set to 5, the firmware monitors the drive feedback velocity VL.FB. When VL.FB goes above BODE.VFTHRESH, an internal counter records the length of time VL.FB was above BODE.VFTHRESH. If the internal counter reaches BODE.VFLIMIT, Fault 133 – Instability during Autotune will be generated.

The smaller BODE.VFLIMIT, the quicker Fault 133 will be generated when VL.FB exceeds BODE.VFLIMIT.

Example

Set BODE.VFTHRESH to 10 RPM:

```
-->BODE.VFTHRESH 10
```

Set BODE.VFLIMIT to 0.500 seconds:

```
-->BODE.VFLIMIT 0.5
```

Set BODE.MODE to 5 to enable stability detection:

```
-->BODE.MODE 5
```

Related Topics

Using the Performance Servo Tuner (→ p. 106)

Using the Performance Servo Tuner: Advanced (→ p. 110)

F133 (→ p. 176)

BODE.MODE, BODE.MODETIMER, BODE.IFLIMIT, BODE.IFTHRESH, BODE.VFLIMIT

19.5 CMP Parameters

This section describes the CMP parameters.

19.5.1 CMPx.ADVANCE	295
19.5.2 CMPx.ARM	296
19.5.3 CMPx.MODBOUND1	297
19.5.4 CMPx.MODBOUND2	298
19.5.5 CMPx.MODE	299
19.5.6 CMPx.MODEN	301
19.5.7 CMPx.MODVALUE	302
19.5.8 CMPx.OUTMASK	303
19.5.9 CMPx.SETPOINT	304
19.5.10 CMPx.SOURCE	306
19.5.11 CMPx.SOURCEVALUE	307
19.5.12 CMPx.STATE	308
19.5.13 CMPx.WIDTH	309
19.5.14 CMPx.WIDTHTYPE	311

19.5.1 CMPx.ADVANCE

General Information	
Type	NV Parameter
Description	Sets the phase advance value for compare.
Units	ms
Range	0 to 30
Default Value	0
Data Type	U32
Start Version	M_01-13-00-000

Hardware Supported

Compare functionality is supported on hardware revisions D, DB, DA, and higher depending on the drive type. Check the label on the side of the drive to ensure the AKD PDMM meets one of the following requirements.

AKD PDMM Type	Hardware Revision Supported	
AKD PDMM	Revision D or higher	
AKD PDMM	Revision DB or higher	
AKD PDMM-T-IC	Revision DA or higher	

Fieldbus	Index/Subindex		Object Start Version
EtherCAT COE and CANopen	53B1h/0	CMP0.ADVANCE	M_01-13-00-000
	53B2h/0	CMP1.ADVANCE	

Description

Use this keyword to compensate for slow output devices such as relays or mechanical devices. The value of this parameter determines how long in advance the compare engine will trigger to compensate for a slow output.

For example, if CMP0.ADVANCE = 10, and CMPx.SETPOINT (→ p. 304) = 1,000,000 counts while the source is moving at 100,000 counts/sec (positive direction), then the compare will trigger when the source value crosses 999,000 counts. This will be 1000 counts early, or 0.01 seconds of 100,000 counts/sec.

CMPx.ADVANCE has a 0.001 ms resolution.

Related Topics

Compare Engines (→ p. 76)

19.5.2 CMPx.ARM

General Information	
Type	NV Parameter
Description	Arms/disarms the specified Compare setpoint.
Units	N/A
Range	Argument 1: 0 to 7 Argument 2: 0 (Disarm) or 1 (Arm)
Default Value	0 (Disarm)
Data Type	Argument 1: Integer Argument 2: Integer
Start Version	M_01-13-00-000

Hardware Supported

Compare functionality is supported on hardware revisions D, DB, DA, and higher depending on the drive type. Check the label on the side of the drive to ensure the AKD PDMM meets one of the following requirements.

AKD PDMM Type	Hardware Revision Supported		
AKD PDMM	Revision D or higher		
AKD PDMM	Revision DB or higher		
AKD PDMM-T-IC	Revision DA or higher		
Fieldbus	Index/Subindex		Object Start Version
EtherCAT COE and CANopen	34C0h/1	CMP0.ARM	M_01-13-00-000
	34C1h/1	CMP1.ARM	

Description

Use this keyword to arm or disarm a Compare setpoint. The setpoint value will only be compared against the Compare source (CMPx.SOURCE (→ p. 306)) if that setpoint is armed. If they match, an output pulse will be generated.

An error will be generated if CMPx.SOURCE, CMPx.MODBOUND1, CMPx.MODBOUND2, CMPx.WIDTH, and CMPx.MODEN are not set prior to enabling CMPx.ARM. If CMPx.SETPOINT is not set prior to enabling CMPx.ARM, the compare will trigger at the last set value, or the default value of 0 if the drive has been power cycled.

Example

The following example arms setpoint 3 for CMP1.

```
-->CMP1.ARM 3 1
```

Related Topics

Compare Engines (→ p. 76)

CMPx.SETPOINT (→ p. 304) | CMPx.SOURCE (→ p. 306)

19.5.3 CMPx.MODBOUND1

General Information	
Type	NV Parameter
Description	Sets the first modulo bound.
Units	Units depend on value of CMPx.SOURCE. See table below.
Range	-9,223,372,036,854,775,808 to 9,223,372,036,854,775,808
Default Value	9,223,372,036,854,775,808
Data Type	Integer
Start Version	M_01-13-00-000

Units

CMPx.SOURCE	Units
0 (FB1)	Depends on FB1.PUNIT (→ p. 470) or custom units.
1 (FB2)	Depends on FB2.PUNIT or custom units.
2 (FB3)	Depends on FB2.PUNIT or custom units.
3 (PL.FB)	Depends on UNIT.PLINEAR or UNIT.PROTARY Rotary: counts, rad, deg, (custom units), 16-bit counts Linear: counts, mm, µm, (custom units), 16-bit counts

Hardware Supported

Compare functionality is supported on hardware revisions D, DB, DA, and higher depending on the drive type. Check the label on the side of the drive to ensure the AKD PDMM meets one of the following requirements.

AKD PDMM Type	Hardware Revision Supported
AKD PDMM	Revision D or higher
AKD PDMM	Revision DB or higher
AKD PDMM-T-IC	Revision DA or higher

Fieldbus	Index/Subindex		Object Start Version
EtherCAT COE and CANopen	34A9h/1	CMP0.MODBOUND1	M_01-13-00-000
	34B9h/1	CMP1.MODBOUND1	

Description

Use this keyword to set the first modulo bound. CMPx.MODBOUND1 and CMPx.MODBOUND2 (→ p. 298) must both be set before the modulo functionality can be activated. There is no requirement that the second modulus bound be larger than the first modulus bound.

CMPx.MODBOUND1 must be set before CMPx.SETPOINT (→ p. 304).

Example

The following example sets the first modulo bound to one billion counts for CMP1.

```
-->CMP1.MODBOUND1 1000000000
```

Related Topics

Compare Engines (→ p. 76)

CMPx.MODBOUND2 (→ p. 298) | CMPx.MODEN (→ p. 301) | CMPx.ARM (→ p. 296)

19.5.4 CMPx.MODBOUND2

General Information	
Type	NV Parameter
Description	Sets the second modulo bound.
Units	Units depend on value of CMPx.SOURCE. See table below.
Range	-9,223,372,036,854,775,808 to 9,223,372,036,854,775,808
Default Value	9,223,372,036,854,775,808
Data Type	Integer
Start Version	M_01-13-00-000

Units

CMPx.SOURCE	Units
0 (FB1)	Depends on FB1.PUNIT (→ p. 470) or custom units.
1 (FB2)	Depends on FB2.PUNIT or custom units.
2 (FB3)	Depends on FB2.PUNIT or custom units.
3 (PL.FB)	Depends on UNIT.PLINEAR or UNIT.PROTARY Rotary: counts, rad, deg, (custom units), 16-bit counts Linear: counts, mm, µm, (custom units), 16-bit counts

Hardware Supported

Compare functionality is supported on hardware revisions D, DB, DA, and higher depending on the drive type. Check the label on the side of the drive to ensure the AKD PDMM meets one of the following requirements.

AKD PDMM Type	Hardware Revision Supported
AKD PDMM	Revision D or higher
AKD PDMM	Revision DB or higher
AKD PDMM-T-IC	Revision DA or higher

Description

Use this keyword to set the second modulo bound. CMPx.MODBOUND1 (→ p. 297) and CMPx.MODBOUND2 must both be set before the modulo functionality can be activated. There is no requirement that the second modulus bound be larger than the first modulus bound.

CMPx.MODBOUND2 must be set before CMPx.SETPOINT (→ p. 304).

Example

The following example sets the second modulo bound to 0 counts for CMP1

```
-->CMP1.MODBOUND2 0
```

Related Topics

Compare Engines (→ p. 76)

CMPx.MODBOUND1 (→ p. 297) | CMPx.MODEN (→ p. 301) | CMPx.ARM (→ p. 296)

19.5.5 CMPx.MODE

General Information	
Type	NV Parameter
Description	Sets the mode for a Compare setpoint.
Units	None
Range	Argument 1: 0 to 7 Argument 2: 0 (Single-shot) or 1 (Continuous)
Default Value	1 (Continuous)
Data Type	Argument 1: Integer Argument 2: Integer
Start Version	M_01-13-00-000

Hardware Supported

Compare functionality is supported on hardware revisions D, DB, DA, and higher depending on the drive type. Check the label on the side of the drive to ensure the AKD PDMM meets one of the following requirements.

AKD PDMM Type	Hardware Revision Supported
AKD PDMM	Revision D or higher
AKD PDMM	Revision DB or higher
AKD PDMM-T-IC	Revision DA or higher

Fieldbus	Index/Subindex	Object Start Version
EtherCAT COE and CANopen	34ADh/1	CMP0.MODE 0
	34AAh/2	CMP0.MODE 1
	34AAh/3	CMP0.MODE 2
	34AAh/4	CMP0.MODE 3
	34AAh/5	CMP0.MODE 4
	34AAh/6	CMP0.MODE 5
	34AAh/7	CMP0.MODE 6
	34AAh/8	CMP0.MODE 7
	34BDh/1	CMP1.MODE 0
	34BAh/2	CMP1.MODE 1
	34BAh/3	CMP1.MODE 2
	34BAh/4	CMP1.MODE 3
	34BAh/5	CMP1.MODE 4
	34BAh/6	CMP1.MODE 5
	34BAh/7	CMP1.MODE 6
	34BAh/8	CMP1.MODE 7

M_01-13-00-000

Description

This keyword sets the mode for a Compare setpoint to either single-shot or continuous. Single-shot automatically disarms the setpoint after a pulse is generated. Continuous mode will keep the setpoint armed after a pulse has been generated.

Example

The following example sets the mode for setpoint 3 to single-shot.

```
-->CMP1.MODE 7 0
```

Related Topics

Compare Engines (→ p. 76)

CMPx.SETPOINT (→ p. 304)

19.5.6 CMPx.MODEN

General Information	
Type	NV Parameter
Description	Enables/disables modulo functionality.
Units	None
Range	0 to 1
Default Value	0 (Disable)
Data Type	Integer
Start Version	M_01-13-00-000

Hardware Supported

Compare functionality is supported on hardware revisions D, DB, DA, and higher depending on the drive type. Check the label on the side of the drive to ensure the AKD PDMM meets one of the following requirements.

AKD PDMM Type	Hardware Revision Supported	
AKD PDMM	Revision D or higher	
AKD PDMM	Revision DB or higher	
AKD PDMM-T-IC	Revision DA or higher	

Fieldbus	Index/Subindex		Object Start Version
EtherCAT COE and CANopen	53A6h/0	CMP0.MODEN	M_01-13-00-000
	53ADh/0	CMP1.MODEN	

Description

This keyword enables or disables modulo functionality on CMPx.

An error will be generated if CMPx.SOURCE, CMPx.MODBOUND1, CMPx.MODBOUND2, and CMPx.WIDTH are not set prior to enabling CMPx.MODEN. If CMPx.SETPOINT is not set prior to enabling CMPx.MODEN, the compare will trigger at the last set value, or the default value of 0 if the drive has been power cycled.

CMPx.MODEN must be set before CMPx.SETPOINT (→ p. 304).

Example

The following example enables modulo for CMP1.

```
-->CMP1.MODEN 1
```

Related Topics

Compare Engines (→ p. 76)

19.5.7 CMPx.MODVALUE

General Information	
Type	R/O Parameter
Description	Reads the modulo value.
Units	Units depend on value of CMPx.SOURCE. See table below.
Range	-9,223,372,036,854,775,808 to 9,223,372,036,854,775,808
Default Value	9,223,372,036,854,775,808
Data Type	Integer
Start Version	M_01-13-00-000

Units

CMPx.SOURCE	Units
0 (FB1)	Depends on FB1.PUNIT (→ p. 470) or custom units.
1 (FB2)	Depends on FB2.PUNIT or custom units.
2 (FB3)	Depends on FB2.PUNIT or custom units.
3 (PL.FB)	Depends on UNIT.PLINEAR or UNIT.PROTARY Rotary: counts, rad, deg, (custom units), 16-bit counts Linear: counts, mm, µm, (custom units), 16-bit counts

Hardware Supported

Compare functionality is supported on hardware revisions D, DB, DA, and higher depending on the drive type. Check the label on the side of the drive to ensure the AKD PDMM meets one of the following requirements.

AKD PDMM Type	Hardware Revision Supported	
AKD PDMM	Revision D or higher	
AKD PDMM	Revision DB or higher	
AKD PDMM-T-IC	Revision DA or higher	

Fieldbus	Index/Subindex		Object Start Version
EtherCAT COE and CANopen	34A8h/0	CMP0.MODVALUE	M_01-13-00-000
	34B8h/0	CMP1.MODVALUE	

Description

Use this keyword to read the modulo value.

Related Topics

Compare Engines (→ p. 76)

CMPx.MODBOUND2 (→ p. 298) | CMPx.MODBOUND2 (→ p. 298) | CMPx.MODEN (→ p. 301) |

CMPx.ARM (→ p. 296)

19.5.8 CMPx.OUTMASK

General Information	
Type	NV Parameter
Description	Sets the output mask.
Units	None
Range	0 to 255
Default Value	0 (Inactive)
Data Type	Integer
Start Version	M_01-13-00-000

Hardware Supported

Compare functionality is supported on hardware revisions D, DB, DA, and higher depending on the drive type. Check the label on the side of the drive to ensure the AKD PDMM meets one of the following requirements.

AKD PDMM Type	Hardware Revision Supported	
AKD PDMM	Revision D or higher	
AKD PDMM	Revision DB or higher	
AKD PDMM-T-IC	Revision DA or higher	

Fieldbus	Index/Subindex		Object Start Version
EtherCAT COE and CANopen	5394h/0	CMP0.OUTMASK	M_01-13-00-000
	539Bh/0	CMP1.OUTMASK	

Description

This keyword sets the binary output mask for CMPx. The mask corresponds to a setpoint index that will be disabled when a pulse is generated.

Example

The following example sets an outmask 0111 that will disable setpoints 0, 1, and 2 if a pulse is generated.

```
-->CMP0.OUTMASK 7
```

Related Topics

Compare Engines (→ p. 76)

CMPx.SETPOINT (→ p. 304)

19.5.9 CMPx.SETPOINT

General Information	
Type	NV Parameter
Description	Sets the value of a Compare setpoint.
Units	Units depend on value of CMPx.SOURCE. See table below.
Range	Argument 1: 0 to 7 Argument 2: -9,223,372,036,854,775,808 to 9,223,372,036,854,775,808
Default Value	9,223,372,036,854,775,808
Data Type	Argument 1: Integer Argument 2: Integer
Start Version	M_01-13-00-000

Units

CMPx.SOURCE	Units
0 (FB1)	Depends on FB1.PUNIT (→ p. 470) or custom units.
1 (FB2)	Depends on FB2.PUNIT or custom units.
2 (FB3)	Depends on FB2.PUNIT or custom units.
3 (PL.FB)	Depends on UNIT.PLINEAR or UNIT.PROTARY Rotary: counts, rad, deg, (custom units), 16-bit counts Linear: counts, mm, μm, (custom units), 16-bit counts

Hardware Supported

Compare functionality is supported on hardware revisions D, DB, DA, and higher depending on the drive type. Check the label on the side of the drive to ensure the AKD PDMM meets one of the following requirements.

AKD PDMM Type	Hardware Revision Supported
AKD PDMM	Revision D or higher
AKD PDMM	Revision DB or higher
AKD PDMM-T-IC	Revision DA or higher

Fieldbus	Index/Subindex	Object Start Version
EtherCAT COE and CANopen	34AAh/1	CMP0.SETPOINT 0
	34AAh/2	CMP0.SETPOINT 1
	34AAh/3	CMP0.SETPOINT 2
	34AAh/4	CMP0.SETPOINT 3
	34AAh/5	CMP0.SETPOINT 4
	34AAh/6	CMP0.SETPOINT 5
	34AAh/7	CMP0.SETPOINT 6
	34AAh/8	CMP0.SETPOINT 7
	34BAh/1	CMP1.SETPOINT 0
	34BAh/2	CMP1.SETPOINT 1
	34BAh/3	CMP1.SETPOINT 2
	34BAh/4	CMP1.SETPOINT 3
	34BAh/5	CMP1.SETPOINT 4
	34BAh/6	CMP1.SETPOINT 5
	34BAh/7	CMP1.SETPOINT 6
	34BAh/8	CMP1.SETPOINT 7

M_01-13-00-000

Description

Use this keyword to set the position value for a Compare setpoint. This position value will be compared against a Compare source (CMPx.SOURCE (→ p. 306)). If they match, an output pulse is generated. A setpoint also requires a width (CMPx.WIDTH (→ p. 309)) and width type (CMPx.WIDTHTYPE (→ p. 311)).

A setpoint must be armed (CMPx.ARM (→ p. 296)) before it is active. If a setpoints value, width, or width type are changed after it has been armed, that setpoint will be automatically disarmed.

Example

The following example sets the value of setpoint 1 to one billion for CMP1.

```
-->CMP1.SETPOINT 1 1000000000
```

Related Topics

Compare Engines (→ p. 76)

19.5.10 CMPx.SOURCE

General Information	
Type	NV Parameter
Description	Sets the Compare source.
Units	None
Range	0 to 3
Default Value	3
Data Type	Integer
Start Version	M_01-13-00-000

Hardware Supported

Compare functionality is supported on hardware revisions D, DB, DA, and higher depending on the drive type. Check the label on the side of the drive to ensure the AKD PDMM meets one of the following requirements.

AKD PDMM Type	Hardware Revision Supported		
AKD PDMM	Revision D or higher		
AKD PDMM	Revision DB or higher		
AKD PDMM-T-IC	Revision DA or higher		

Fieldbus	Index/Subindex		Object Start Version
EtherCAT COE and CANopen	538Fh/0	CMP0.SOURCE	M_01-13-00-000
	5390h/0	CMP1.SOURCE	

Description

Setpoints (CMPx.SETPOINT (→ p. 304)) are compared against Compare source values. The setpoint must be armed (CMPx.ARM (→ p. 296)) for it to be compared against a source. If they match, an output pulse is generated.

Value	Compare Source
0	Feedback 1 (FB1)
1	Feedback 2 (FB2)
2	Feedback 3 (FB3)
3	Position Loop Feedback (PL.FB (→ p. 625))

The source must be set before CMPx.SETPOINT (→ p. 304).

Example

The following example sets the source to PL.FB for CMP0.

```
-->CMP0.SOURCE 3
```

Related Topics

Compare Engines (→ p. 76)

19.5.11 CMPx.SOURCEVALUE

General Information	
Type	R/O Parameter
Description	Reads the current value of the selected source for CMPx.SOURCE.
Units	Units depend on value of CMPx.SOURCE. See table below.
Range	N/A
Default Value	N/A
Data Type	Float
Start Version	M_01-13-00-000

Units

CMPx.SOURCE	Units
0 (FB1)	Depends on FB1.PUNIT (→ p. 470) or custom units.
1 (FB2)	Depends on FB2.PUNIT or custom units.
2 (FB3)	Depends on FB2.PUNIT or custom units.
3 (PL.FB)	Depends on UNIT.PLINEAR or UNIT.PROTARY Rotary: counts, rad, deg, (custom units), 16-bit counts Linear: counts, mm, µm, (custom units), 16-bit counts

Hardware Supported

Compare functionality is supported on hardware revisions D, DB, DA, and higher depending on the drive type. Check the label on the side of the drive to ensure the AKD PDMM meets one of the following requirements.

AKD PDMM Type	Hardware Revision Supported
AKD PDMM	Revision D or higher
AKD PDMM	Revision DB or higher
AKD PDMM-T-IC	Revision DA or higher

Description

Reads the current value of the selected source for CMPx.SOURCE.

Example

If CMP0.SOURCE = 3 (PL.FB), CMP0.SOURCEVALUE will return the current value of PL.FB.

Related Topics

Compare Engines (→ p. 76) | CMPx.SOURCEVALUE

19.5.12 CMPx.STATE

General Information	
Type	R/O Parameter
Description	Reads the state of a Compare setpoint.
Units	None
Range	0 to 7
Default Value	0 (Inactive)
Data Type	Integer
Start Version	M_01-13-00-000

Hardware Supported

Compare functionality is supported on hardware revisions D, DB, DA, and higher depending on the drive type. Check the label on the side of the drive to ensure the AKD PDMM meets one of the following requirements.

AKD PDMM Type	Hardware Revision Supported	
AKD PDMM	Revision D or higher	
AKD PDMM	Revision DB or higher	
AKD PDMM-T-IC	Revision DA or higher	

Fieldbus	Index/Subindex		Object Start Version
EtherCAT COE and CANopen	34C0h/2	CMP0.STATE	M_01-13-00-000
	34C1h/2	CMP1.STATE	

Description

Use this keyword to read the state of a Compare setpoint. The state indicates whether a compare pulse is being generated. If the state is 1, then a pulse is being generated. If the state is 0, no pulse is being generated.

Related Topics

Compare Engines (→ p. 76)

CMPx.SETPOINT (→ p. 304)

19.5.13 CMPx.WIDTH

General Information	
Type	NV Parameter
Description	Sets the width for a Compare setpoint.
Units	Position counts or microseconds depending on CMPx.WIDTHTYPE (→ p. 311). If CMPx.WIDTHTYPE = 0 (position counts), then units depend on CMPx.SOURCE (see table below).
Range	Argument 1: 0 to 7 Argument 2: 0 to 18,446,744,073,709,551,615 (position counts) or 0 to 65,535,000 (microseconds)
Default Value	0
Data Type	Argument 1: Integer Argument 2: Integer
Start Version	M_01-13-00-000

Units

If CMPx.WIDTHTYPE = 0 (position counts), determine units with the following table.

CMPx.SOURCE	Units
0 (FB1)	Depends on FB1.PUNIT (→ p. 470) or custom units.
1 (FB2)	Depends on FB2.PUNIT or custom units.
2 (FB3)	Depends on FB2.PUNIT or custom units.
3 (PL.FB)	Depends on UNIT.PLINEAR or UNIT.PROTARY Rotary: counts, rad, deg, (custom units), 16-bit counts Linear: counts, mm, µm, (custom units), 16-bit counts

Hardware Supported

Compare functionality is supported on hardware revisions D, DB, DA, and higher depending on the drive type. Check the label on the side of the drive to ensure the AKD PDMM meets one of the following requirements.

AKD PDMM Type	Hardware Revision Supported
AKD PDMM	Revision D or higher
AKD PDMM	Revision DB or higher
AKD PDMM-T-IC	Revision DA or higher

Fieldbus	Index/Subindex	Object Start Version
EtherCAT COE and CANopen	34ABh/1	CMP0.WIDTH 0
	34AAh/2	CMP0.WIDTH 1
	34AAh/3	CMP0.WIDTH 2
	34AAh/4	CMP0.WIDTH 3
	34AAh/5	CMP0.WIDTH 4
	34AAh/6	CMP0.WIDTH 5
	34AAh/7	CMP0.WIDTH 6
	34AAh/8	CMP0.WIDTH 7
	34BBh/1	CMP1.WIDTH 0
	34BAh/2	CMP1.WIDTH 1
	34BAh/3	CMP1.WIDTH 2
	34BAh/4	CMP1.WIDTH 3
	34BAh/5	CMP1.WIDTH 4
	34BAh/6	CMP1.WIDTH 5
	34BAh/7	CMP1.WIDTH 6
	34BAh/8	CMP1.WIDTH 7

M_01-13-00-000

Description

Use this keyword to set the width for a Compare setpoint. The width defines for how much time or for how many position counts a pulse will be generated once a setpoint is active.

If a pulse width's type is in microseconds, the resolution is as follows:

Width	Resolution
0 to 65,535 μ s	μ s
65,536 μ s to 65.535 s	ms

CMPx.WIDTH must be set before CMPx.SETPOINT (→ p. 304).

Example

The following example sets the width type of setpoint 7 to microseconds, and the width of setpoint 7 to 1000 microseconds.

```
-->CMP0.WIDTHTYPE 7 1
```

```
-->CMP0.WIDTH 7 1000
```

Related Topics

Compare Engines (→ p. 76)

CMPx.WIDTHTYPE (→ p. 311)

19.5.14 CMPx.WIDTHTYPE

General Information	
Type	NV Parameter
Description	Sets the width-type for a Compare setpoint.
Units	None
Range	Argument 1: 0 to 7 Argument 2: 0 (position) to 1 (time)
Default Value	0
Data Type	Argument 1: Integer Argument 2: Integer
Start Version	M_01-13-00-000

Hardware Supported

Compare functionality is supported on hardware revisions D, DB, DA, and higher depending on the drive type. Check the label on the side of the drive to ensure the AKD PDMM meets one of the following requirements.

AKD PDMM Type	Hardware Revision Supported
AKD PDMM	Revision D or higher
AKD PDMM	Revision DB or higher
AKD PDMM-T-IC	Revision DA or higher

Fieldbus	Index/Subindex	Object Start Version
EtherCAT COE and CANopen	34ACh/1	CMP0.WIDTHTYPE 0
	34AAh/2	CMP0.WIDTHTYPE 1
	34AAh/3	CMP0.WIDTHTYPE 2
	34AAh/4	CMP0.WIDTHTYPE 3
	34AAh/5	CMP0.WIDTHTYPE 4
	34AAh/6	CMP0.WIDTHTYPE 5
	34AAh/7	CMP0.WIDTHTYPE 6
	34AAh/8	CMP0.WIDTHTYPE 7
	34BCh/1	CMP1.WIDTHTYPE 0
	34BAh/2	CMP1.WIDTHTYPE 1
	34BAh/3	CMP1.WIDTHTYPE 2
	34BAh/4	CMP1.WIDTHTYPE 3
	34BAh/5	CMP1.WIDTHTYPE 4
	34BAh/6	CMP1.WIDTHTYPE 5
	34BAh/7	CMP1.WIDTHTYPE 6
	34BAh/8	CMP1.WIDTHTYPE 7

Description

Use this keyword to set the width-type for a Compare setpoint. The width-type determines whether the width of the Compare pulse is in position counts or units of time (microseconds).

Example

The following example sets the width type of setpoint 7 to microseconds, and the width of setpoint 7 to 1000 microseconds.

```
-->CMP0.WIDTHTYPE 7 1
```

```
-->CMP0.WIDTH 7 1000
```

Related Topics

Compare Engines (→ p. 76)

CMPx.WIDTH (→ p. 309)

19.6 CS Parameters

Controlled stop (CS) parameters set the values for the controlled stop process.

19.6.1 CS.DEC	314
19.6.2 CS.STATE	315
19.6.3 CS.TO	316
19.6.4 CS.VTHRESH	317

19.6.1 CS.DEC

General Information	
Type	NV Parameter
Description	Sets the deceleration value for the controlled stop process.
Units	Rotary: rps/s, rpm/s, deg/s ² , rad/s ² Linear: counts/s ² , mm/s ² , μm/s ²
Range	Rotary: 0.002 to 833,333.333 rps/s 0.112 to 50,000,000.000 rpm/s 0.009 to 300,000,000.000 deg/s ² 0.012 to 5,235,987.968 rad/s ² Linear: 16,000.000 to 3,579,139,408,000.000 counts/s ² 0.031*MOTOR.PITCH (→ p. 599) to 833333.333*MOTOR.PITCH (→ p. 599) mm/s ² 30.994*MOTOR.PITCH (→ p. 599) to 833333333.333*MOTOR.PITCH (→ p. 599) μm/s ²
Default Value	Rotary: 166.669 rps/s 10,000.000 rpm/s 60,000.000 deg/s ² 1,047.2 rad/s ² Linear: 715,840,000.000 counts/s ² 166.714*MOTOR.PITCH (→ p. 599)MOTOR.PITCH (→ p. 599) mm/s ² 166,714.191*MOTOR.PITCH (→ p. 599)MOTOR.PITCH (→ p. 599) μm/s ²
Data Type	Float
Start Version	M_01-00-00-000

Fieldbus	Index/Subindex	Object Start Version
EtherCAT COE and CANopen	3440h/1	M_01-00-00-000

Description

This parameter sets the deceleration value for the controlled stop process.

Related Topics

Controlled Stop (→ p. 81)

Digital Inputs and Outputs (pg 1)

Fault and Warning Messages (→ p. 174)

CS.VTHRESH (→ p. 317), CS.TO (→ p. 316), DRV.DIS, DIN1.MODE TO DIN7.MODE (→ p. 325), DRV.DISM MODE (→ p. 372), DRV.DISSOURCES (→ p. 373)

19.6.2 CS.STATE

General Information	
Type	R/O Parameter
Description	Returns the internal status of the controlled stop process.
Units	N/A
Range	N/A
Default Value	N/A
Data Type	N/A
Start Version	M_01-00-00-000

Fieldbus	Index/Subindex	Object Start Version
EtherCAT COE and CANopen	3441h/0	M_01-00-00-000

Description

CS.STATE returns the internal state machine value of the controlled stop.

0 = controlled stop is not occurring.

1 = controlled stop is occurring

Related Topics

Controlled Stop (→ p. 81)

Digital Inputs and Outputs (pg 1)

Fault and Warning Messages (→ p. 174)

CS.DEC (→ p. 314), CS.VTHRESH (→ p. 317), CS.TO (→ p. 316) DRV.DISMODE (→ p. 372),
 DRV.DISSOURCES (→ p. 373)

19.6.3 CS.TO

General Information	
Type	NV Parameter
Description	Sets the time value for the drive velocity to be within CS.VTHRESH (→ p. 317).
Units	ms
Range	1 to 30,000 ms
Default Value	6 ms
Data Type	Integer
Start Version	M_01-00-00-000

Fieldbus	Index/Subindex	Object Start Version
EtherCAT COE and CANopen	3440h/3	M_01-00-00-000

Description

CS.TO is the time value for the drive velocity to be within CS.VTHRESH (→ p. 317) before the drive disables.

Example

Set time value to 100 ms:

```
-->CS.TO 100
```

Related Topics

Controlled Stop (→ p. 81)

Digital Inputs and Outputs

Fault and Warning Messages (→ p. 174)

CS.DEC (→ p. 314), CS.VTHRESH (→ p. 317), CS.STATE, DRV.DIS, DIN1.MODE TO DIN7.MODE (→ p. 325), DRV.DISM MODE (→ p. 372), DRV.DISSOURCES (→ p. 373)

19.6.4 CS.VTHRESH

General Information	
Type	NV Parameter
Description	Sets the velocity threshold for the controlled stop.
Units	rpm, rps, deg/s
Range	Rotary: 0.000 to 15,000.000 rpm 0.000 to 250.000 rps 0.000 to 90,000.000 deg/s 0.000 to 1,570.796 rad/s Linear: 0.000 to 1,073,741,824,000.000 counts/s 0.000 to 8,000.000 mm/s 0.000 to 8,000,000.000 µm/s
Default Value	5 rpm
Data Type	Float
Start Version	M_01-00-00-000

Fieldbus	Index/Subindex	Object Start Version
EtherCAT COE and CANopen	3440h/2	M_01-00-00-000

Description

CS.VTHRESH is the velocity threshold for the controlled stop algorithm.

Example

Set velocity threshold for controlled stop at 100 rpm:

```
-->CS.VTHRESH 100
```

Related Topics

Controlled Stop (→ p. 81)

Digital Inputs and Outputs (pg 1)

Fault and Warning Messages (→ p. 174)

CS.DEC (→ p. 314), CS.TO (→ p. 316), CS.STATE (→ p. 315), DRV.DIS (→ p. 371), DIN1.MODE TO DIN7.MODE (→ p. 325), DRV.DISMODE (→ p. 372), DRV.DISSOURCES (→ p. 373)

19.7 DIN Parameters

This section describes the DIN parameters.

19.7.1 DIN.HCMD1 TO DIN.HCMD4	319
19.7.2 DIN.LCMD1 to DIN.LCMD4	320
19.7.3 DIN.ROTARY	321
19.7.4 DIN.STATES	322
19.7.5 DIN1.FILTER TO DIN7.FILTER	323
19.7.6 DIN1.INV to DIN7.INV	324
19.7.7 DIN1.MODE TO DIN7.MODE	325
19.7.8 DIN1.PARAM TO DIN7.PARAM	327
19.7.9 DIN1.STATE TO DIN7.STATE	329
19.7.10 DIN9.STATE to DIN11.STATE	330
19.7.11 DIN21.FILTER to DIN32.FILTER	331
19.7.12 DIN21.STATE to DIN32.STATE	332

19.7.1 DIN.HCMD1 TO DIN.HCMD4

General Information	
Type	NV parameter
Description	A buffer of commands to be used in digital input "command buffer" mode.
Units	None
Range	A string of up to 128 characters
Default Value	<Empty>
Data Type	String
Start Version	M_01-02-08-000

Description

DIN.HCMDx sets the string of commands to be used in the digital input mode command buffer. Digital input mode **9-Command buffer** can execute four different sets of command buffers.

Each set of command buffers contains two buffers:

- High buffer: Executes upon a rising edge of a digital input.
- Low buffer: Executes upon a falling edge of a digital input.

DIN.HCMDx sets the string for the four high buffers (depending on x).

Example

Set the command buffer mode to digital input 1:

```
DIN1.MODE 9
```

Set the first sets of buffers to digital input 1:

```
DIN1.PARAM 1
```

Set the command DRV.OPMODE 0 to the high buffer:

```
DIN.HCMD1 DRV.OPMODE 1
```

Now, upon a rising edge in digital input 1, the drive mode is 1.

Related Topics

Command Buffer

1 Digital Inputs and Outputs

DIN1.MODE TO DIN7.MODE (→ p. 325), DIN1.PARAM TO DIN7.PARAM (→ p. 327), DIN.LCMD1 to DIN.LCMD4 (→ p. 320)

19.7.2 DIN.LCMD1 to DIN.LCMD4

General Information	
Type	NV parameter
Description	A buffer of commands to be used in digital input "command buffer" mode.
Units	N/A
Range	A string of up to 128 characters
Default Value	Empty
Data Type	String
Start Version	M_01-02-08-000

Description

DIN.LCMDx sets the string of commands to be used in the digital input mode command buffer. Digital input mode **9-Command buffer** can execute four different sets of command buffers.

Each set of command buffers contains two buffers:

- High buffer: Executes upon a rising edge of a digital input.
- Low buffer: Executes upon a falling edge of a digital input.

DIN.LCMDx sets the string for the four "low" buffers, depending on x.

Example

Set the command buffer mode to digital input 1:

```
DIN1.MODE 9
```

Set the first sets of buffers to digital input 1:

```
DIN1.PARAM 1
```

Set the command DRV.OPMODE 0 to the "low buffer":

```
DIN.LCMD1 DRV.OPMODE 0
```

Now, upon a falling edge in digital input 1, the drive mode is 0.

Related Topics

Command Buffer

1 Digital Inputs and Outputs

DIN1.MODE TO DIN7.MODE (→ p. 325), DIN1.PARAM TO DIN7.PARAM (→ p. 327), DIN.HCMD1 TO DIN.HCMD4 (→ p. 319)

19.7.3 DIN.ROTARY

General Information	
Type	R/O Parameter
Description	Reads the rotary knob value.
Units	N/A
Range	0 to 99
Default Value	N/A
Data Type	Integer
Start Version	M_01-00-00-000

Description

DIN.ROTARY reads the rotary knob value.

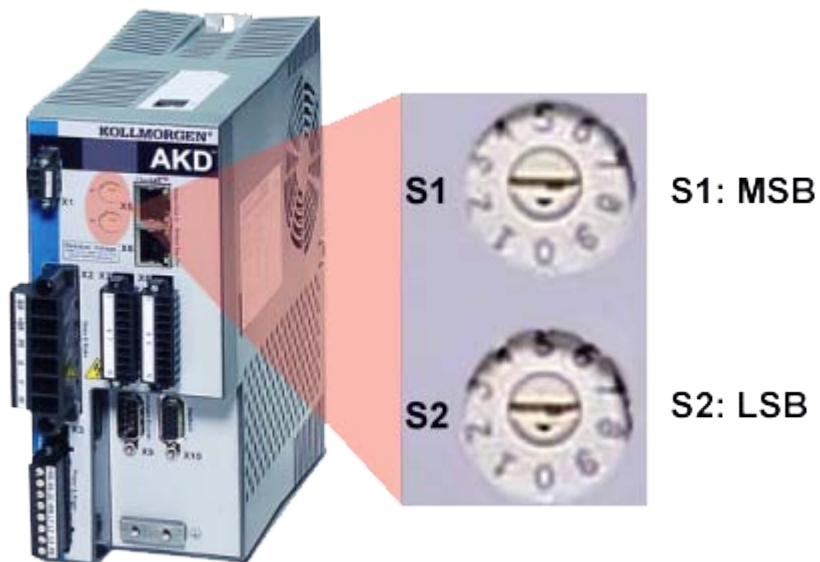

Related Topics

- 1 Digital Inputs and Outputs

19.7.4 DIN.STATES

General Information	
Type	R/O Parameter
Description	Reads the digital input states.
Units	N/A
Range	0000000 to 1111111
Default Value	N/A
Data Type	String
Start Version	M_01-00-00-000

Description

DIN.STATES reads the states of the digital inputs. The leftmost bit represents digital input 1 (DIN1) and the rightmost bit represents digital input 7 (DIN7).

Related Topics

- 1 Digital Inputs and Outputs

19.7.5 DIN1.FILTER TO DIN7.FILTER

General Information	
Type	R/W Parameter
Description	Filter mode for digital inputs 1 to 71 to 3.
Units	N/A
Range	0 to 3
Default Value	1 for DIN1 and DIN2 2 for DIN3 to DIN7
Data Type	Integer
Start Version	M_01-03-07-000

Fieldbus	Index/Subindex		Object Start Version
EtherCAT COE and CANopen	51CBh/0	DIN1.FILTER	M_01-03-07-000
	51CCh/0	DIN2.FILTER	
	51CDh/0	DIN3.FILTER	
	51CEh/0	DIN4.FILTER	
	51CFh/0	DIN5.FILTER	
	51D0h/0	DIN6.FILTER	
	51D1h/0	DIN7.FILTER	

Description

This parameter sets the digital input filter configuration for channel x when followed with the values defined below. DINx.FILTER retrieves this information when not followed by data.

Value	Description
DINX.FILTER 0	The drive digital input channel detects all input signals with an input pulse width of ≥ 40 ns (no filtering applied).
DINX.FILTER 1	The drive digital input channel detects all input signals with an input pulse width of ≥ 10.24 μ s, ± 0.64 μ s (fast filter applied).
DINX.FILTER 2	The drive digital input channel detects all input signals with an input pulse width of ≥ 163 μ s, ± 10.24 μ s (standard filter applied).
DINX.FILTER 3	The drive digital input channel detects all input signals with an input pulse width of ≥ 2.62 ms, ± 0.16384 ms (slow filter applied).

Related Topics

Digital Inputs and Outputs

19.7.6 DIN1.INV to DIN7.INV

General Information	
Type	RW Parameter
Description	Sets the indicated polarity of a digital input mode.
Units	N/A
Range	0 to 1
Default Value	0
Data Type	Boolean
Start Version	M_01-00-00-000

Description

Sets the indicated polarity of a digital input mode.

Example

```
DIN1.INV = 0 : Input is active high.
```

```
DIN1.INV = 1 : Input is active low.
```

Related Topics

Digital Inputs and Outputs

19.7.7 DIN1.MODE TO DIN7.MODE

General Information	
Type	R/W Parameter
Description	Sets the digital input modes.
Units	N/A
Range	0 to 26
Default Value	0
Data Type	Integer
Start Version	M_01-00-00-000

Fieldbus	Index/Subindex		Object Start Version
EtherCAT COE and CANopen	3562h/0	DIN1.MODE	M_01-00-00-000
	3565h/0	DIN2.MODE	
	3568h/0	DIN3.MODE	
	356Bh/0	DIN4.MODE	
	36F6h/0	DIN5.MODE	
	36F9h/0	DIN6.MODE	
	36FCh/0	DIN7.MODE	
	60FDh/0	DIN1.MODE TO DIN6.MODE	

Description

This parameter sets the functionality of the digital inputs. Digital inputs and corresponding X7 and X8 pin connectors are described in the *AKD PDMM Installation Manual*, section 8.16.4, Digital Inputs. The table below summarizes the digital input modes; for detailed descriptions of each mode, see Digital Inputs and Outputs (pg 1).

DINx.MODE	Description	Task
0	No function; off	None
1	Fault reset	Background
2	Start motion task (use DINx.PARAM for this task)	1 KHz
6	Start jog	Background
7	Reserved	None
8	Zero latch	Background
9	Command buffer	Background
10	Control fault relay	Background
11	Home reference	1 kHz
12	Reserved	None
13	Controlled Stop (→ p. 81)	1 kHz
14	Reserved	None
15	Quick stop	Background
17	Activate electronic gear position shift	Background

DINx.MODE	Description	Task
18	Positive limit switch	4 kHz
19	Negative limit switch	4kHz
20	Brake release	Background
21	Current limit	4 kHz
22	Opmode and Command Source switch	Background
23	Change algebraic sign of the measured analog input voltage.	1 kHz
24	Reserved	1 kHz
25	Controlled stop without re-enable.	1 kHz
26	Suspend Motion	1 kHz

Related Topics

Command Buffer

Digital Inputs (pg 1)

Controlled Stop (→ p. 81)

Clearing Faults (→ p. 194)

F245 (→ p. 181)

CS Parameters (→ p. 313)

19.7.8 DIN1.PARAM TO DIN7.PARAM

General Information	
Type	R/W Parameter
Description	Sets a value used as an extra parameter for digital inputs nodes.
Units	N/A
Range	-9,223,372,036,854,775,000 to +9,223,372,036,854,775,000 Note: Varies based on DINx.MODE. See below.
Default Value	0
Data Type	Float
Start Version	M_01-00-00-000

Fieldbus	Index/Subindex	Object Start Version	
EtherCAT COE and CANopen	DIN1.PARAM	M_01-00-00-000	
	3474h/2, 3474/9		DIN2.PARAM
	3474h/3, 3474/A		DIN3.PARAM
	3474h/4, 3474/B		DIN4.PARAM
	3474h/5, 3474/C		DIN5.PARAM
	3474h/6, 3474/D		DIN6.PARAM
	3474h/7, 3474/E		DIN7.PARAM

Description

This parameter sets a value that is used as an extra parameter for digital inputs nodes.

Example

The digital input mode "Start motion task" is used to start a motion task. This mode uses an extra parameter as the ID of the motion task to be started.

Range

DINx.PARAM is used for various Digital Input modes. This causes the parameter's range to change based on the current Digital Input mode selected with the corresponding DINx.MODE

Listed below are the possible ranges for each Digital input mode.

If an input mode is not listed, then the default range above is used.

Input Mode	Min	Max	Notes
2	0	128	
6	Velocity Min	Velocity Max	This value changes based on user selected velocity units.
9	0	4	
17	Position Min	Position Max	This value changes based on user selected position units.
21	0	DRV.IPEAK	This value changes based on the specific AKD PDMMs drive limits.
22	0	32	See Digital Input Mode 22 for details.
23	0	2056	See Digital Input Mode 23 for details.

Dependency on DINx.MODE

Typically, the user can set DINx.PARAM before the corresponding DINx.MODE is set. However, if DINx.PARAM is set before DINx.MODE is set, and the value of DINx.PARAM is outside the new DINx.MODE's range, then DINx.PARAM will be set to zero.

Example:

DIN1.MODE is set to 0 by default

DIN1.PARAM is set to 200

DIN1.MODE is changed to 2 (execute motion tasks)

200 is larger than the maximum for DIN1.MODE 2, so DIN1.PARAM will be set to 0 to prevent errors.

Related Topics

1 Digital Inputs and Outputs

19.7.9 DIN1.STATE TO DIN7.STATE

General Information	
Type	R/O Parameter
Description	Reads a specific digital input state.
Units	N/A
Range	0 to 1
Default Value	N/A
Data Type	Integer
Start Version	M_01-00-00-000

Description

Reads the state of one digital input according to the number identified in the command.

Related Topics

- 1 Digital Inputs and Outputs

19.7.10 DIN9.STATE to DIN11.STATE

General Information	
Type	NV Parameter
Description	Shows on selected pin if signal is high or low.
Units	N/A
Range	0 to 1
Default Value	0
Data Type	U8
Start Version	M_01-05-00-000

Description

This parameter allows the user to see the actual level of the input signal, when the IO is set to input mode. Parameter value is 0 if signal is low and 1 if signal is high. DIOx.INV can affect the value in this register.

This parameter can be read at any time. The value is only guaranteed to correspond to the output on the X9 connector when DRV.EMUEMODE is set to 10 and the DIOX.DIR is 0.

Related Topics

DRV.EMUEMODE (→ p. 379)

19.7.11 DIN21.FILTER to DIN32.FILTER

General Information	
Type	R/W Parameter
Description	Filter mode for digital inputs 21 to 32.
Units	N/A
Range	0 to 3
Default Value	2
Data Type	Integer
Start Version	M_01-03-07-000

Description

This parameter sets the digital input filter configuration for channel x when followed with the values defined below. DINx.FILTER retrieves this information when not followed by data.

Value	Description
DINX.FILTER 0	The drive digital input channel detects all input signals with an input pulse width of ≥ 40 ns (no filtering applied).
DINX.FILTER 1	The drive digital input channel detects all input signals with an input pulse width of ≥ 10.24 μ s, ± 0.64 μ s (fast filter applied).
DINX.FILTER 2	The drive digital input channel detects all input signals with an input pulse width of ≥ 163 μ s, ± 10.24 μ s (standard filter applied).
DINX.FILTER 3	The drive digital input channel detects all input signals with an input pulse width of ≥ 2.62 ms, ± 0.16384 ms (slow filter applied).

Related Topics

Digital Inputs and Outputs

19.7.12 DIN21.STATE to DIN32.STATE

General Information	
Type	R/O Parameter
Description	Reads a specific digital input state.
Units	N/A
Range	0 to 1
Default Value	N/A
Data Type	Integer
Start Version	M_01-00-00-000

Description

DIN21.STATE to DIN32.STATE reads the state of one digital input according to the number identified in the command.

Related Topics

- 1 Digital Inputs and Outputs

19.8 DIO Parameters

This section describes the DIO parameters.

19.8.1 DIO9.INV to DIO11.INV	334
19.8.2 DIO9.DIR to DIO11.DIR	335

19.8.1 DIO9.INV to DIO11.INV

General Information	
Type	NV Parameter
Description	Inverting the output voltage of the IO, when in the output direction.
Units	NA
Range	0 to 1
Default Value	0
Data Type	U8
Start Version	M_01-05-00-000

Fieldbus Information

Fieldbus	Index/Subindex	Parameter	Object Start Version
EtherCAT COE and CANopen	5258h/0	DIO9.INV	M_01-05-00-000
	5254h/0	DIO10.INV	
	5256h/0	DIO11.INV	

Description

This parameter changes the logic sense of the differential input/output signals. When false, a logic 1 occurs when the + signal is higher than the – signal. When true, a logic 1 occurs when the – signal is higher than the + signal.

The drive output parameters DOUTx.STATE and DOUTx.STATEU are not affected by changes in this parameter. The drive input parameters DINx.STATE will be affected.

This parameter can be set at any time. It will be ignored unless DRV.EMUEMODE is set to 10.

Related Topics

DIN1.STATE TO DIN7.STATE (→ p. 329)

DOUT1.STATE AND DOUT2.STATE (→ p. 343)

DOUT1.STATEU AND DOUT2.STATEU (→ p. 344)

DRV.EMUEMODE (→ p. 379)

19.8.2 DIO9.DIR to DIO11.DIR

General Information	
Type	NV Parameter
Description	Changing direction of the IOs from the X9 connector.
Units	N/A
Range	0 to 1
Default Value	0
Data Type	U8
Start Version	M_01-05-00-000

Fieldbus Information

Fieldbus	Index/Subindex	Parameter	Object Start Version
EtherCAT COE and CANopen	5257h/0	DIO9.DIR	M_01-05-00-000
	5253h/0	DIO10.DIR	
	5255h/0	DIO11.DIR	

Description

This parameter changes the direction of the general purpose IO from the X9 connector. If DIOx.DIR is set 0 then the IO configured as an input, while if DIOx.DIR is 1 the IO is configured as an output.

DIO9.DIR controls pins 1 and 2

DIO10.DIR controls pins pin 4 and 5

DIO11.DIR controls pins pin 7 and 8.

This parameter can be set at any time. It will be ignored unless DRV.EMUEMODE is set to 10.

Related Topics

DIN1.STATE TO DIN7.STATE (→ p. 329)

DOUT1.STATE AND DOUT2.STATE (→ p. 343)

DOUT1.STATEU AND DOUT2.STATEU (→ p. 344)

DIO9.INV to DIO11.INV (→ p. 334)

DRV.EMUEMODE (→ p. 379)

19.9 DOUT Parameters

This section describes the DOUT parameters.

19.9.1 DOUT.CTRL	337
19.9.2 DOUT.RELAYMODE	338
19.9.3 DOUT.STATES	339
19.9.4 DOUT1.MODE and DOUT2.MODE	340
19.9.5 DOUT1.PARAM AND DOUT2.PARAM	341
19.9.6 DOUT1.STATE AND DOUT2.STATE	343
19.9.7 DOUT1.STATEU AND DOUT2.STATEU	344
19.9.8 DOUT9.MODE to DOUT11.MODE	345
19.9.9 DOUT9.PARAM to DOUT11.MODE	346
19.9.10 DOUT9.STATE to DOUT11.STATE	347
19.9.11 DOUT9.STATEU to DOUT11.STATEU	348
19.9.12 DOUT21.STATE to DOUT32.STATE	349
19.9.13 DOUT21.STATEU to DOUT32.STATEU	350

19.9.1 DOUT.CTRL

General Information	
Type	NV Parameter
Description	Sets the source of digital output(s) (firmware or fieldbus).
Units	N/A
Range	0 to 1
Default Value	0
Data Type	Boolean
Start Version	M_01-00-00-000

Description

DOUT.CTRL sets the source of the digital output(s):

0 = Firmware controlled

1 = Fieldbus controlled

Related Topics

1.4 Digital Outputs

19.9.2 DOUT.RELAYMODE

General Information	
Type	R/W Parameter
Description	Indicates faults relay mode.
Units	N/A
Range	0 to 1
Default Value	0
Data Type	Integer
Start Version	M_01-00-00-000

Fieldbus	Index/Subindex	Object Start Version
EtherCAT COE and CANopen	5060h/0	M_01-00-00-000

Description

DOUT.RELAYMODE indicates the faults relay mode as follows:

If DOUT.RELAYMODE= 0 and faults exist, then the relay is open.

If DOUT.RELAYMODE= 0 and faults do not exist, then the relay is closed.

If DOUT.RELAYMODE = 1 and the drive is disabled, then the relay is open.

If DOUT.RELAYMODE = 1 and the drive is enabled, then the relay is closed.

Related Topics

1.4 Digital Outputs

19.9.3 DOUT.STATES

General Information	
Type	R/O Parameter
Description	Reads the state of the digital output(s).
Units	N/A
Range	0 to 11
Default Value	N/A
Data Type	String
Start Version	M_01-00-00-000

Description

DOUT.STATES reads the states of the digital output(s). The leftmost bit represents DOUT1 and the rightmost bit represents DOUT2.

Related Topics

1.4 Digital Outputs

19.9.4 DOUT1.MODE and DOUT2.MODE

General Information	
Type	NV Parameter
Description	Sets the digital output mode.
Units	N/A
Range	0 to 24
Default Value	0
Data Type	Integer
Start Version	M_01-04-02-000

Description

DOUTx.MODE sets the functionality of the digital output(s). The table below summarizes the digital output modes; for detailed descriptions of each mode, see Digital Inputs and Outputs.

DOUTx.MODE	Description
0	User (default = 0)
1	Mains ready
2	Software limit switch reached
3	Move complete
4	In position
5	Position greater than x
6	Position less than x
7	Drive produced warning
8	Drive enabled
9	Reserved
10	Motor brake
11	Drive produced fault
12	Absolute velocity greater than x
13	Absolute velocity less than x
14	Homing complete
15	PLS.STATE bits or connected
16	Description Command buffer Active
17	Mt in Position
20	Controlled Stop Active
21	Immediate Fault Disable
22	In Rush Relay State
23	Compare Output
24	STO Status

Related Topics

1.4 Digital Outputs

DOUT1.PARAM AND DOUT2.PARAM (→ p. 341)

19.9.5 DOUT1.PARAM AND DOUT2.PARAM

General Information	
Type	NV Parameter
Description	Sets extra parameters for the digital output(s).
Units	N/A
Range	0 Note: Range changes based on Digital Output Mode. See below.
Default Value	0
Data Type	Integer
Start Version	M_01-00-00-000

Description

Set the extra parameter needed for the digital output's calculations.

Range

DOUTx.PARAM is used for various Digital Output modes. This causes the parameter's range to change based on the current Digital Output mode selected with the corresponding DOUTx.MODE.

Below is a list of the possible range for each Digital Output Mode.

If an output mode is not listed, then the default range of 0 is used.

Input Mode	Min	Max	Notes
3	Position Min	Position Max	This value changes based on user selected position units.
4	Position Min	Position Max	This value changes based on user selected position units.
5	Position Min	Position Max	This value changes based on user selected position units.
6	Position Min	Position Max	This value changes based on user selected position units.
12	0	Velocity Max	This value changes based on user selected velocity units.
13	0	Velocity Max	This value changes based on user selected velocity units.
15	0	255	None.
17	Position Min	Position Max	This value changes based on user selected position units.
23	0	1	Selects the compare engine 0 (CMP0) or 1 (CMP1).

Dependency on DOUTx.MODE

Since the default range of DOUTx.PARAM does not allow a user to enter a value, DOUTx.MODE must be set to a mode which uses DOUTx.PARAM before a value can be set.

Each time DOUTx.MODE is changed, DOUTx.PARAM is automatically set to zero to prevent unintended interactions.

Digital Output Mode 15: PLS.STATE bits OR connected

The output mode produces a high signal if at least one of the PLS.STATE bits is high (the PLS is active) and if the corresponding bit in the DOUTx.PARAM parameter also has been set to high. The DOUTx.PARAM command connects the PLS.STATE bits to the digital output itself and thus acts as an enable mask.

In mode 15 DOUTx.PARAM is set from the Digital Outputs section of the Programmable Limit Switches screen.

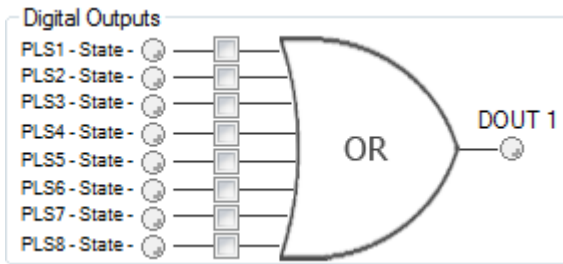

This mode is valid for all opmodes and command source combinations.

Example

```
|<- Bit 7 to 0 ->|
```

```
DOUT1.PARAM = 23 = 0b 0 0 0 1 0 1 1 1 (Binary code)
```

The digital output 1 is active when bit 0 or bit 1 or bit 2 or bit 4 of PLS.STATE is high. All other bits within PLS.STATE are not considered by the digital output mode due to the DOUT1.PARAM setting. Do not use decimal places for the DOUTx.PARAM parameter for this particular digital output mode.

Related Topics

1.4 Digital Outputs

19.9.6 DOUT1.STATE AND DOUT2.STATE

General Information	
Type	R/O Parameter
Description	Reads the digital output state.
Units	N/A
Range	0 to 1
Default Value	N/A
Data Type	Integer
Start Version	M_01-00-00-000

Description

Reads the state of one digital output according to the value stated in the command.

Related Topics

1.4 Digital Outputs

19.9.7 DOUT1.STATEU AND DOUT2.STATEU

General Information	
Type	R/W Parameter
Description	Sets the state of the digital output node.
Units	N/A
Range	0 to 1
Default Value	0
Data Type	Integer
Start Version	M_01-01-01-000

Description

Set the state of the digital output node as follows:

0 = deactivated

1 = activated

DOUT1.STATEU and DOUT2.STATEU are used when DOUTx.MODE = 0 (user mode).

Related Topics

1.4 Digital Outputs

19.9.8 DOUT9.MODE to DOUT11.MODE

General Information	
Type	NV Parameter
Description	Sets the digital output mode.
Units	N/A
Range	0, 23
Default Value	0
Data Type	Integer
Start Version	

Description

DOUTx.MODE sets the functionality of the digital output(s). The table below summarizes the digital output modes; for detailed descriptions of each mode, see Digital Inputs and Outputs.

DOUTx.MODE	Description
0	User (default = 0)
23	Compare Output

Related Topics

1.4 Digital Outputs

DOUT1.PARAM AND DOUT2.PARAM (→ p. 341)

Compare Engines (→ p. 76)

19.9.9 DOUT9.PARAM to DOUT11.MODE

General Information	
Type	NV Parameter
Description	Selects Compare Engine 0 or 1 for DOUTx.
Units	N/A
Range	0 to 1
Default Value	0
Data Type	Integer
Start Version	N/A

Description

DOUT9.PARAM, DOUT10.PARAM, and DOUT11.PARAM select the compare engine (CMP0 or CMP1) for the output.

DOUTx.PARAM value	Description
0	Compare Engine 0
1	Compare Engine 1

Related Topics

1.4 Digital Outputs

19.9.10 DOUT9.STATE to DOUT11.STATE

General Information	
Type	NV parameter
Description	Shows on selected pin if signal is high or low.
Units	N/A
Range	0 to 1
Default Value	0
Data Type	U8
Start Version	M_01-05-00-000

Description

This parameter allows the user to see the actual level of the output signal, when the IO is set to output mode. Parameter value is 0 if signal is low and 1 if signal is high. DIOx.INV can affect the signals driven onto the X9 connector.

This parameter can be read at any time. The value is only guaranteed to correspond to the output on the X9 connector when DRV.EMUEMODE is set to 10 and the DIOx.DIR is 0.

Related Topics

DOUT9.STATEU to DOUT11.STATEU (→ p. 348)

DRV.EMUEMODE (→ p. 379)

19.9.11 DOUT9.STATEU to DOUT11.STATEU

General Information	
Type	NV Parameter
Description	Allows user to set level of selected pin to high or low.
Units	N/A
Range	0 to 1
Default Value	0
Data Type	U8
Start Version	M_01-05-00-000

Description

This parameter allows the user to set the level of the output signal, when the IO is set to output mode. Parameter value is 0 if signal is low and 1 if signal is high. DIOx.INV can affect the signals driven onto the X9 connector.

This parameter can be written at any time. The value is only guaranteed to correspond to the output on the X9 connector when DRV.EMUEMODE is set to 10 and the DIOX.DIR is 0.

Example

The following settings set the direction for the differential signals on pin 4 and 5, so that the output will have a high level signal.

First set the following settings:

```
DRV.EMUEMODE 10
DIO10.DIR 1
DOUT10.STATEU 1
```

Then change the level of the signal:

```
DOUT.STATEU 0
```

or

```
DIO10.INV
```

Note: Inverting the signal will also alter the signal in input mode.

Related Topics

DRV.EMUEMODE (→ p. 379)

19.9.12 DOUT21.STATE to DOUT32.STATE

General Information	
Type	R/O Parameter
Description	Reads the digital output state.
Units	N/A
Range	0 to 1
Default Value	N/A
Data Type	Integer
Start Version	M_01-00-00-000

Description

DOUTx.STATE reads the state of one digital output according to the value stated in the command.

Related Topics

1.4 Digital Outputs

19.9.13 DOUT21.STATEU to DOUT32.STATEU

General Information	
Type	R/W Parameter
Description	Sets the state of the digital output node.
Units	N/A
Range	0 to 1
Default Value	0
Data Type	Integer
Start Version	M_01-01-01-000

Description

DOUTx.STATEU sets the state of the digital output node as follows:

0 = deactivated

1 = activated

DOUTx.STATEU is used when DOUTx.MODE = 0 (user mode).

Related Topics

1.4 Digital Outputs

19.10 DRV Parameters

This section describes the DRV parameters.

19.10.1 DRV.ACC	354
19.10.2 DRV.ACTIVE	356
19.10.3 DRV.BLINKDISPLAY	357
19.10.4 DRV.BOOTTIME	358
19.10.5 DRV.CLRFAULTHIST	359
19.10.6 DRV.CLRFAULTS	360
19.10.7 DRV.CMDDELAY	361
19.10.8 DRV.CMDSOURCE	362
19.10.9 DRV.CRASHDUMP	363
19.10.10 DRV.CUSTOMIDENTIFIER	364
19.10.11 DRV.DBILIMIT	365
19.10.12 DRV.DEC	366
19.10.13 DRV.DIFVAR	368
19.10.14 DRV.DIR	369
19.10.15 DRV.DIS	371
19.10.16 DRV.DISMODE	372
19.10.17 DRV.DISSOURCES	373
19.10.18 DRV.DISSOURCESMASK	374
19.10.19 DRV.DISTO	375
19.10.20 DRV.DOWNLOADALLOWED	376
19.10.21 DRV.EMUHECKSPEED	377
19.10.22 DRV.EMUEDIR	378
19.10.23 DRV.EMUEMODE	379
19.10.24 DRV.EMUEMTURN	381
19.10.25 DRV.EMUEPULSEWIDTH	382
19.10.26 DRV.EMUERES	383
19.10.27 DRV.EMUEZOFFSET	384
19.10.28 DRV.EN	385
19.10.29 DRV.ENDEFAULT	386
19.10.30 DRV.ERRORLIST	387
19.10.31 DRV.FAULTDISPLAYMODE	388
19.10.32 DRV.FAULTHIST	389

19.10.33 DRV.FAULT1 to DRV.FAULT10	390
19.10.34 DRV.FAULTS	391
19.10.35 DRV.HANDWHEELSRC	392
19.10.36 DRV.HELP	393
19.10.37 DRV.HELPALL	394
19.10.38 DRV.HWENABLE	395
19.10.39 DRV.HWENDELAY	396
19.10.40 DRV.HWENMODE	397
19.10.41 DRV.ICONT	398
19.10.42 DRV.INFO	399
19.10.43 DRV.IPEAK	401
19.10.44 DRV.IZERO	402
19.10.45 DRV.LIST	403
19.10.46 DRV.LOGICVOLTS	404
19.10.47 DRV.MEMADDR	405
19.10.48 DRV.MEMDATA	406
19.10.49 DRV.MOTIONDISSOURCES	407
19.10.50 DRV.NAME	408
19.10.51 DRV.NVCHECK	409
19.10.52 DRV.NVLIST	410
19.10.53 DRV.NVLOAD	411
19.10.54 DRV.NVSAVE	412
19.10.55 DRV.ONTIME	413
19.10.56 DRV.OPMODE	414
19.10.57 DRV.READFORMAT	415
19.10.58 DRV.REBOOT	416
19.10.59 DRV.RSTVAR	417
19.10.60 DRV.RUNTIME	418
19.10.61 DRV.SETUPREQBITS	419
19.10.62 DRV.SETUPREQLIST	421
19.10.63 DRV.STOP	422
19.10.64 DRV.TEMPERATURES	423
19.10.65 DRV.TYPE	424
19.10.66 DRV.VER	425

19.10.67 DRV.VERIMAGE	426
19.10.68 DRV.WARNING1 to DRV.WARNING3	427
19.10.69 DRV.WARNINGS	428
19.10.70 DRV.ZERO	429

19.10.1 DRV.ACC

General Information	
Type	NV Parameter
Description	Describes the acceleration ramp for the velocity loop.
Units	Depends on UNIT.ACCROTARY (pg 1) or UNIT.ACCLINEAR Rotary: rps/s, rpm/s, deg/s ² , (custom units)/s ² , rad/s ² Linear: counts/s ² , mm/s ² , μm/s ² , (custom units)/s ²
Range	Note: The range and default values of (custom units)/s ² units depend on the values of PIN and POUT. The range and default values listed in this table are derived from the default values of PIN and POUT. Rotary: 0.002 to 833,333.333 rps/s 0.112 to 50,000,000.000 rpm/s 0.009 to 300,000,000.000 deg/s ² 0.155 to 4,166,666.752 (custom units)/s ² 0.012 to 5,235,987.968 rad/s ² Linear: 16,000.000 to 3,579,139,408,000.000 counts/s ² 0.031*MOTOR.PITCH (→ p. 599) to 833,333.333*MOTOR.PITCH (→ p. 599) mm/s ² 30.995*MOTOR.PITCH (→ p. 599) to 2,147,483.647*MOTOR.PITCH (→ p. 599) μm/s ² 0.155 to 2,147,483.647 (custom units)/s ²
Default Value	Note: The range and default values of (custom units)/s ² units depend on the values of PIN and POUT. The range and default values listed in this table are derived from the default values of PIN and POUT. Rotary: 166.669 rps/s 10,000.000 rpm/s 60,000.000 deg/s ² 833.333 (custom units)/s ² 1,047.2 rad/s ² Linear: 715,840,000.000 counts/s ² 166.714*MOTOR.PITCH (→ p. 599) mm/s ² 166,714.191*MOTOR.PITCH (→ p. 599) μm/s ² 833.571 (custom units)/s ²
Data Type	Float
Start Version	M_01-00-00-000

Fieldbus	Index/Subindex	Object Start Version
EtherCAT COE and CANopen	3501h/0 6083h (→ p. 972) /0	M_01-00-00-000

Description

Describes the acceleration ramp for the velocity central loop.

Related Topics

10.1 Limits

DRV.DEC (→ p. 366)

19.10.2 DRV.ACTIVE

General Information	
Type	R/O Parameter
Description	Reads the enable status of an axis.
Units	N/A
Range	0, 1, 3
Default Value	N/A
Data Type	Integer
Start Version	M_01-00-00-000

Description

DRV.ACTIVE reads the enable status of an axis as follows:

- DRV.ACTIVE = 0 drive disabled
- DRV.ACTIVE = 1 drive enabled
- DRV.ACTIVE = 3 drive enabled and in dynamic brake mode

There is no state 2.

When the drive is in state 3, the drive display shows a blinking decimal point.

If an axis is not enabled (DRV.ACTIVE is 0), but DRV.EN (→ p. 385) is 1 and the hardware enable is high, read the value of DRV.DISSOURCES (→ p. 373) to query the reason that the drive is not enabled.

Related Topics

10.3 Enable/Disable

DRV.EN (→ p. 385), DRV.DISSOURCES (→ p. 373)

19.10.3 DRV.BLINKDISPLAY

General Information	
Type	Command
Description	Causes the display to blink for 10 seconds.
Units	N/A
Range	N/A
Default Value	N/A
Data Type	N/A
Start Version	M_01-00-00-000

*For Profinet, write a value of 0 into the PNU to execute a command.

Description

DRV.BLINKDISPLAY causes the drive display located on the front of the drive to blink for 10 seconds.

This command allows the user to identify the drive that is currently communicating with EWV¹.

¹Embedded Workbench Views

19.10.4 DRV.BOOTTIME

General Information	
Type	R/O
Description	Returns the time when the current session booted up.
Units	Days:Hours:Minutes:Seconds
Range	N/A
Default Value	N/A
Data Type	String
Start Version	M_01-06-05-000

Description

DRV.BOOTTIME returns the time that the current session started running. This time includes total amount of time from all previous sessions.

This keyword can be used with DRV.RUNTIME to determine the length of time the drive has been running since it was last power cycled.

Session Time = DRV.RUNTIME – DRV.BOOTTIME

Related Topics

DRV.RUNTIME (→ p. 418)

19.10.5 DRV.CLRFAULTHIST

General Information	
Type	Command
Description	Clears the fault history log in the NV.
Units	N/A
Range	N/A
Default Value	N/A
Data Type	N/A
Start Version	M_01-00-00-000

*For Profinet, write a value of 0 into the PNU to execute a command.

Description

DRV.CLRFAULTHIST clears the fault history from the nonvolatile memory of the drive.

This command erases all faults returned by DRV.FAULTHIST (→ p. 389).

19.10.6 DRV.CLRFAULTS

General Information	
Type	Command
Description	Tries to clear all active faults in the drive.
Units	N/A
Range	N/A
Default Value	N/A
Data Type	N/A
Start Version	M_01-00-00-000

*For Profinet, write a value of 0 into the PNU to execute a command.

Description

When DRV.CLRFAULTS is sent, the drive will try to clear all active faults. When a fault occurs, the fault is registered in the drive fault handler. DRV.CLRFAULTS clears the fault from the drive fault handler. However, if the fault still exists in the system, DRV.CLRFAULTS fails and the fault is re-registered in the fault handler.

If the DRV.CLRFAULTS succeeds, then the reply to DRV.FAULTS states that no faults exist. If the condition that triggered the fault is still present, the fault condition will remain.

See Fault and Warning Messages (→ p. 174) for details regarding the behavior of individual faults.

Note that executing a drive disable (DRV.DIS (→ p. 371)) followed by a drive enable (DRV.EN (→ p. 385)) has the same effect as executing DRV.CLRFAULTS.

Related Topics

Clearing Faults (→ p. 194)

DRV.FAULTS (→ p. 391), DRV.EN (→ p. 385), DRV.DIS (→ p. 371)

19.10.7 DRV.CMDDELAY

General Information	
Type	Command
Description	Issues a delay before next command is executed.
Units	ms
Range	0 to 5,000 ms
Default Value	0 ms
Data Type	Float
Start Version	M_01-03-00-000

Description

This parameter is used when drive commands are used in a script and a delay is needed between the execution of two consecutive commands. DRV.CMDDELAY creates a delay in the execution of drive commands. In the period of time specified, no commands are executed. This feature is especially useful for command buffers.

Example

If the script is:

```
DRV.EN
IL.CMDU 0.1
```

then DRV.CMDDELAY is used between the two entries to delay execution 5 ms until the drive is enabled:

```
DRV.EN
DRV.CMDDELAY 5
IL.CMDU 0.1
```

19.10.8 DRV.CMDSOURCE

General Information	
Type	NV Parameter
Description	Sets the command source (service, fieldbus, analog input, gearing, digital, or Bode).
Units	N/A
Range	0 to 5
Default Value	0
Data Type	Integer
Start Version	M_01-00-00-000

Description

DRV.CMDSOURCE specifies the source of the command to the drive. DRV.OPMODE (→ p. 414) sets the operation mode to the relevant control loop.

DRV.CMDSOURCE values can be set as follows:

Value	Description
0	Service, TCP/IP command
1	Fieldbus command
2	Gearing command
3	Analog command
5	Program command

If DRV.CMDSOURCE is set to 5 then DRV.OPMODE must be set to 3.

DRV.CMDSOURCE can be changed while the drive is enabled or disabled. If you use the terminal to change the operation mode, then it is recommended that you disable the drive before changing the command source.

⚠ WARNING

If you change DRV.CMDSOURCE from the terminal while the drive is enabled, the system may experience a step change in command.

Example

To set the command source to the TCP/IP channel and the operation mode to velocity:

```
-->DRV.CMDSOURCE 0
```

```
-->DRV.OPMODE 1
```

Related Topics

DRV.OPMODE (→ p. 414)

19.10.9 DRV.CRASHDUMP

General Information	
Type	Command
Description	Retrieves diagnostic information after the drive crashes.
Units	N/A
Range	N/A
Default Value	N/A
Data Type	N/A
Start Version	M_01-00-00-000

Description

Drives rarely crash, but if a crash occurs, information that can help diagnose the cause of a crash is saved to the nonvolatile (NV) memory within the drive. After the drive is restarted, you can use the DRV.CRASHDUMP command to retrieve this diagnostic information, which can be emailed to Kollmorgen for further support.

If the drive crashes (display flashes an F and three bars), it saves the diagnostic information to a specific block of the drive NV memory. The DRV.CRASHDUMP command then prints the diagnostic information from this NV memory block. Subsequent crash conditions will overwrite the NV memory block. Since the NV memory block is overwritten, but never erased, the DRV.CRASHDUMP command always shows the diagnostic information for the most recent crash.

19.10.10 DRV.CUSTOMIDENTIFIER

General Information	
Type	NV Parameter
Description	Sets the customer defined identifier string for a device.
Units	N/A
Range	N/A
Default Value	N/A
Data Type	String
Start Version	M_01-12-05-000

Fieldbus Information

Fieldbus	Index/Subindex	Object Start Version
EtherCAT COE and CANopen	2032h/0	M_01-12-05-000

Description

Use DRV.CUSTOMIDENTIFIER to assign a unique string to a device. The string must use the following formatting rules:

- ASCII characters only
- 32 character max length
- No spaces in string

The string is displayed on the device overview screen and in the start page's device discovery table.

WorkBench has found the following devices.

[? Is your device is not shown?](#)

Name	Status	IP Address	MAC Address	Model Number	Firmware Version	Custom Identifier
\(^<>^)/	Free	10.154.95.119	00240B007448	AKD-P00306-NBEC-0000	01-12-04-000-58763-alpha	-
AKD_63	Busy	10.154.95.63	00240B010C4D	AKD-P00306-NBEC-0000	01-12-04-000-00000_2014-...	MyCustomIdentifier
MAI AN-7	Free	10.155.94.419	00221B005AEE	AKD-P00306-NBEC-0000	M_01-12-04-000	

Related Topics

DRV.NAME (→ p. 408)

19.10.11 DRV.DBILIMIT

General Information	
Type	NV Parameter
Description	Sets the maximum amplitude of the current for dynamic braking.
Units	Arms
Range	0 to minimum of drive peak current (DRV.IPEAK) and motor peak current (MOTOR.IPEAK).
Default Value	Minimum of drive continuous current (DRV.ICONT) and motor continuous current (MOTOR.ICONT).
Data Type	Float
Start Version	M_01-00-00-000

Fieldbus	Index/Subindex	Object Start Version
EtherCAT COE and CANopen	3444h/0	M_01-00-00-000

Description

This parameter sets the maximum amplitude of the current for dynamic braking.

Example

Setting DRV.DBILIMIT to 2 limits the dynamic brake current to 2 Arms.

Related Topics

10.4 Controlled Stop

19.6 CS Parameters

10.5 Dynamic Braking

DRV.DISMODE (→ p. 372)

19.10.12 DRV.DEC

General Information	
Type	NV Parameter
Description	Sets the deceleration value for the velocity loop.
Units	Depends on UNIT.ACCROTARY (pg 1) or UNIT.ACCLINEAR (pg 1) Rotary: rps/s, rpm/s, deg/s ² , (custom units)/s ² , rad/s ² Linear: counts/s ² , mm/s ² , μm/s ² , (custom units)/s ²
Range	Rotary: 0.002 to 833,333.333 rps/s 0.112 to 50,000,000.000 rpm/s 0.009 to 300,000,000.000 deg/s ² 0.155 to 4,166,666.752 (custom units)/s ² 0.012 to 5,235,987.968 rad/s ² Linear: 16,000.000 to 3,579,139,408,000.000 counts/s ² 0.031*MOTOR.PITCH to 833,333.333*MOTOR.PITCH mm/s ² 30.994*MOTOR.PITCH to 833,333,333.333*MOTOR.PITCH μm/s ² 0.155 to 4,166,666.667 (custom units)/s ²
Default Value	Rotary: 166.669 rps/s 10,000.000 rpm/s 60,000.000 deg/s ² 833.333 (custom units)/s ² 1,047.2 rad/s ² Linear: 715,840,000.000 counts/s ² 166.71*MOTOR.PITCH4MOTOR.PITCH (→ p. 599) mm/s ² 166,714.191*MOTOR.PITCHMOTOR.PITCH (→ p. 599) μm/s ² 833.571 (custom units)/s ²
Data Type	Float
Start Version	M_01-00-00-000

Fieldbus	Index/Subindex	Object Start Version
EtherCAT COE and CANopen	3522h/0 6084h (→ p. 972) /0	M_01-00-00-000

Description

DRV.DEC sets the deceleration value for the velocity loop command (VL.CMDU (→ p. 709)) and for the analog

velocity command (). The operation mode (DRV.OPMODE (→ p. 414)) must be set to velocity mode for this command to function.

Related Topics

10.4 Controlled Stop

10.1 Limits

DRV.ACC (→ p. 354), DRV.OPMODE (→ p. 414)

19.10.13 DRV.DIFVAR

General Information	
Type	R/O
Description	Lists all parameters which differ from their default value.
Units	N/A
Range	N/A
Default Value	N/A
Data Type	N/A
Start Version	M_01-05-01-000

Description

This parameter displays all parameters which have different values than their default setting. The actual value of each parameter is directly shown after the command name and the corresponding default value is then shown in brackets.

This command also shows differences in parameters which hold a string, such as DRV.NAME.

Example

```
-->DRV.DIFVAR
DRV.EMUEMODE 10 (0)
DRV.NAME MyDrive(no-name)
FB1.ENCRESP 0(1024)
IL.KP 50.009(24.811)
PL.KP 99.998(49.999)
VL.KP 0.108(0.000)
```

19.10.14 DRV.DIR

General Information	
Type	R/W Parameter
Description	Changes drive direction.
Units	N/A
Range	0 to 1
Default Value	0
Data Type	Integer
Start Version	M_01-00-00-000

Fieldbus	Index/Subindex	Object Start Version
EtherCAT COE and CANopen	352Ah/0	M_01-00-00-000

Description

DRV.DIR changes the direction of the motor by changing the algebraic sign of the current command and position feedback value according to the figure below.

Note the following when using DRV.DIR:

- You can only change the DRV.DIR command when the drive is disabled.
- The drive status changes to "Axis not homed" as soon as the DRV.DIR parameter changes value (see DRV.MOTIONSTAT).
- You must verify the settings of the hardware limit switches. If necessary, switch the positive and negative hardware limit switches by swapping the wires at the digital inputs.

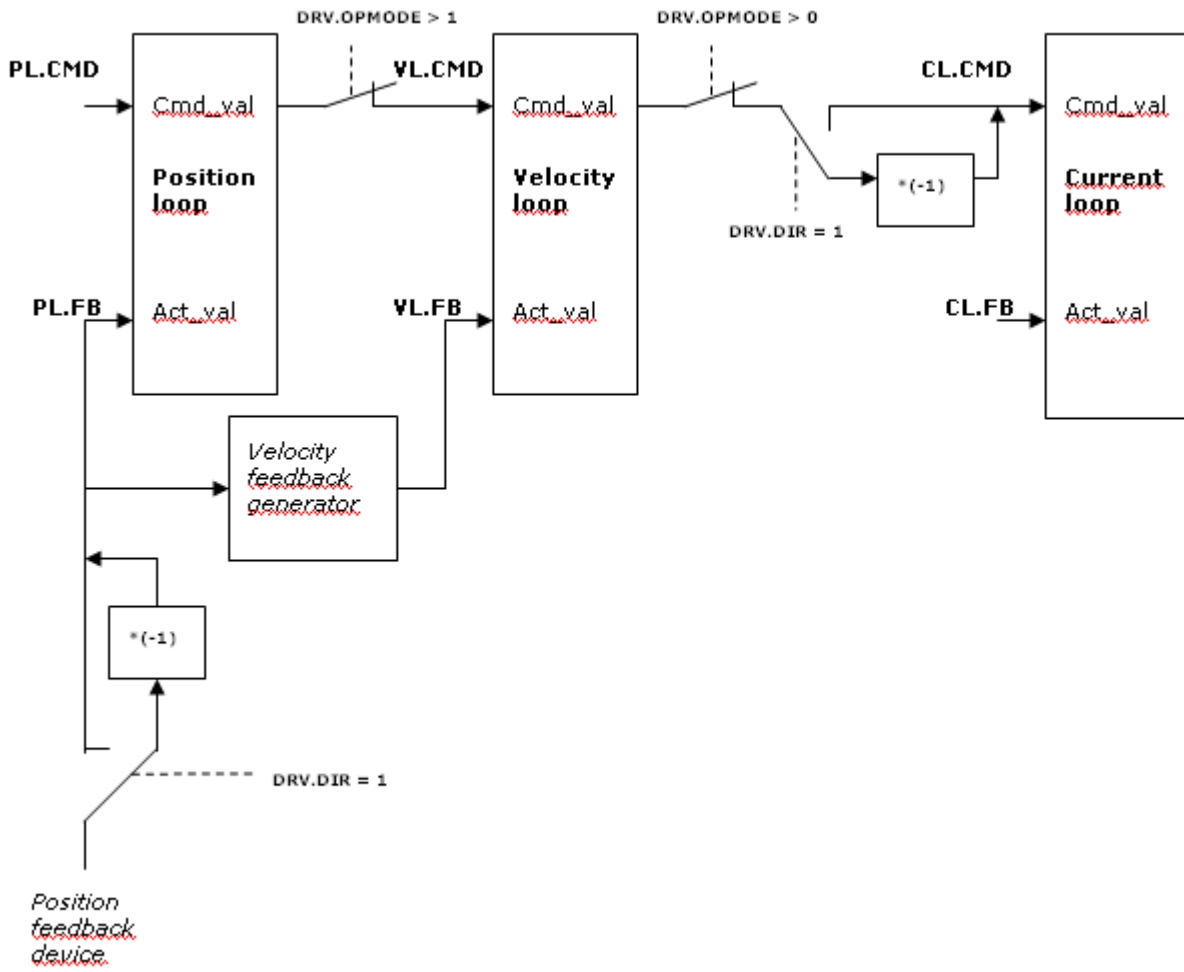

19.10.15 DRV.DIS

General Information	
Type	Command
Description	Disables the axis (software).
Units	N/A
Range	N/A
Default Value	Analog drive software enabled. All other types of drive software disabled.
Data Type	N/A
Start Version	M_01-00-00-000

Fieldbus	Index/Subindex	Object Start Version
EtherCAT COE and CANopen	3443h/0	M_01-00-00-000

*For Profinet, write a value of 0 into the PNU to execute a command.

Description

DRV.DIS issues a software disable to the drive. The method by which the drive will be disabled (either immediately or with a ramp down first) is controlled by DRV.DISMODOE (→ p. 372).

By querying the value of DRV.ACTIVE (→ p. 356), you can check whether the drive is currently enabled or disabled.

By querying the value of DRV.DISSOURCES (→ p. 373), you can check whether the software enable bit is high (software enabled was issued by executing DRV.EN) or the software enable bit is low (software disable was issued by executing DRV.DIS).

If DRV.DIS is commanded the emergency timeout is started. If the drive does not disable or activate dynamic brake within DRV.DISTO (→ p. 375), fault "F703" (→ p. 191) is reported.

Related Topics

15.3 Clearing Faults

10.4 Controlled Stop

DRV.EN (→ p. 385), DRV.DISSOURCES (→ p. 373), DRV.ACTIVE (→ p. 356), DRV.DISMODOE (→ p. 372), DRV.DISTO (→ p. 375)

19.10.16 DRV.DISMODE

General Information	
Type	NV Parameter
Description	Selects among disable immediately or stop and then disable options.
Units	N/A
Range	0 to 3
Default Value	0
Data Type	Integer
Start Version	M_01-00-00-000

Fieldbus	Index/Subindex	Object Start Version
EtherCAT COE and CANopen	35FFh/0	M_01-00-00-000

Description

DRV.DISMODE sets the drive reaction to a DRV.DIS (→ p. 371) or fieldbus command.

NOTE

You must disable the drive in order to set DRV.DISMODE.

Value	Behavior
0	Disable axis immediately. If MOTOR.BRAKEIMM = 1, the brake is applied as soon as the power stage disables.
1	Use dynamic brake to ramp down. The drive remains in the dynamic brake state after the motor has stopped. The drive is disabled in the sense that it does not close the control loop and cannot perform a motion, but PWM stays active.
2	Use a controlled stop to ramp down and then disable the drive.
3	Use a controlled stop to ramp down, and then use dynamic brake. The drive remains in the dynamic brake state after the motor has stopped. The drive is disabled in the sense that it does not close the control loop and cannot perform a motion, but PWM stays active.

WARNING

Be careful with vertical loads when modifying this parameter. Coordinate this parameter's correct setting properly with the drive brake settings. If these settings are not coordinated, then vertical loads may have no stopping or holding force when the drive is disabled and the load could fall. See Using AKD PDMM in a Vertical Axis (→ p. 69).

Related Topics

10.4 Controlled Stop

19.6 CS Parameters

10.5 Dynamic Braking

DRV.DBLIMIT (→ p. 365), DRV.DISTO (→ p. 375), CS.VTHRESH (→ p. 317)

19.10.17 DRV.DISSOURCES

General Information	
Type	R/O Parameter
Description	Returns the possible reason for a drive disable.
Units	N/A
Range	N/A
Default Value	N/A
Data Type	Integer
Start Version	M_01-00-00-000

Description

DRV.DISSOURCES is a bitwise parameter that returns the status of possible causes of a drive disable. If this parameter is 0, then the drive is enabled.

The return value specific bits are as follows:

Bit	Status and Response	Drive Action
0	Software disable (execute DRV.EN to issue software enable)	Performs action configured by DRV.DISMODE.
1	Fault exists (read DRV.FAULTS to get the active faults)	Device disables using the defined reaction for the detected fault.
2	Hardware disable (remote enable input is low)	Power stage disabled.
3	In-rush disable (the in-rush relay is opened)	Performs action configured by DRV.DISMODE.
4	Initialization disable (the drive did not finish the initialization process)	Power stage disabled.
5	Controlled stop disable from a digital input.	Controlled stop.

Related Topics

Controlled Stop (→ p. 81)

DRV.ACTIVE, DRV.FAULTS, DRV.EN, DRV.DIS

19.10.18 DRV.DISSOURCESMASK

General Information	
Type	R/O parameter
Description	Returns a bitmap of all bits in DRV.DISSOURCES that can be set to one on a given drive.
Units	N/A
Range	N/A
Default Value	N/A
Data Type	Integer
Start Version	M_01-07-00-000

Description

DRV.DISSOURCESMASK is a bitwise parameter that returns all possible causes of a drive disable. If a bit is set, the drive can be disabled for this reason.

The return value specific bits are as follows:

Bit	Status and Response
0	Software triggered disable
1	Fault exists
2	Hardware Enable input inactive
3	In-rush relay state prevents enable
4	Initialization not complete
5	Controlled stop requested from digital input
6	Field bus requested disable

For most AKD PDMM models, this parameter will return the value 63.

Related Topics

DRV.DISSOURCES (→ p. 373)

19.10.19 DRV.DISTO

General Information	
Type	R/W Parameter
Description	Sets the emergency timeout
Units	ms
Range	0 to 120,000 ms
Default Value	1,000 ms
Data Type	U32
Start Version	M_01-00-00-000

Fieldbus	Index/Subindex	Object Start Version
EtherCAT COE and CANopen	3445h/0	M_01-00-00-000

Description

This timer starts when DRV.DIS (→ p. 371) is issued (regardless of the DRV.DIS (→ p. 371) origin). After this timeout elapses, the actual state of the drive is compared to the DRV.DISMODE (→ p. 372) setting. If the actual state does not match the DRV.DISMODE (→ p. 372) setting, a fault is reported and the hardware immediately executes the DRV.DISMODE setting (for instance, disable or activate dynamic brake). Setting DRV.DISTO to 0 will disable the timeout.

Related Topics

10.4 Controlled Stop

DRV.DIS (→ p. 371), DRV.DISMODE (→ p. 372)

19.10.20 DRV.DOWNLOADALLOWED

General Information	
Type	R/O Parameter
Description	Returns whether the drive is in a safe state to begin a firmware download.
Units	N/A
Range	0 to 1
Default Value	N/A
Data Type	Integer
Start Version	M_01-09-02-000

Description

This parameter returns whether the drive is in a safe state to begin a firmware download. A download can only be performed if the value is one. If the value is zero, EWV¹ will block the download.

For an AKD PDMM or NSD, the value depends on the drive enable status. For a CPS, the value depends on the enable states of the NSDs on its string. If one more more NSDs are enabled on a string, download to the CPS will be blocked.

Related Topics

10.1 Limits

¹Embedded Workbench Views

19.10.21 DRV.EMUECHECKSPEED

General Information	
Type	R/W
Description	Enable/disable comparison of motor velocity and maximum emulated encoder velocity. See Fault F486 for details.
Units	None
Range	0 to 1
Default Value	0 (disabled)
Data Type	Boolean
Start Version	M_01-06-00-000

Fieldbus	Index/Subindex	Object Start Version
EtherCAT COE and CANopen	520Eh/0	M_01-06-00-000

Description

Enables comparison of the current motor velocity (or EEO pulse rate for DRV.EMUEMODE (→ p. 379) 15 to 17) against the maximum speed the emulated encoder output can generate. If the commanded speed exceeds DRV.EMUECHECKSPEED, fault F486 is raised.

For DRV.EMUEMODE 1 to 14, the commanded speed is based on lines/rev (DRV.EMUERES (→ p. 383)) and the pulse width (DRV.EMUEPULSEWIDTH (→ p. 382)).

For DRV.EMUEMODE 15 to 17 the commanded speed depends on the rate defined by changes in DRV.EMUESTEPCMD.

Related Topics

DRV.EMUEMODE

19.10.22 DRV.EMUEDIR

General Information	
Type	R/W Parameter
Description	Sets the direction of the emulated encoder output (EEO) signal.
Units	N/A
Range	0 to 1
Default Value	0
Data Type	Integer
Start Version	M_01-00-00-000

Fieldbus	Index/Subindex	Object Start Version
EtherCAT COE and CANopen	3493h/0	M_01-00-00-000

Description

This parameter sets the direction of the emulated encoder output (EEO). DRV.DIR (→ p. 369) also effects the output direction (through an XOR, "exclusive or", operation). The drive uses DRV.DIR (→ p. 369) and DRV.EMUEDIR to decide the direction of the EEO. If DRV.DIR (→ p. 369) and DRV.EMUEDIR have the same value, then DRV.EMUEDIR is set to 0 (meaning an increase in the motor feedback will result an increase of the EEO and vice-versa). If these parameters have different values, then DRV.EMUEDIR is set to 1 (meaning an increase in the motor feedback will result in a decrease of the EEO and vice-versa).

19.10.23 DRV.EMUEMODE

General Information	
Type	R/W Parameter
Description	Sets the mode of the emulated encoder output (EEO) connector.
Units	N/A
Range	0 to 17
Default Value	0
Data Type	Integer
Start Version	M_01-00-00-000

Fieldbus	Index/Subindex	Object Start Version
EtherCAT COE and CANopen	3534h/0	M_01-00-00-000

Description

When the emulated encoder output (EEO) is configured to generate an index pulse (Z pulse) once per rev (DRV.EMUEMODE is 1, 6, or 8) this parameter and DRV.EMUEZOFFSET define the location of the Z pulse. DRV.EMUEZOFFSET defines the position of the Z pulse within one revolution. The pulse is generated each time this position is reached. For example, if this value is set to 32,768 (180 degrees), the Z pulse will be generated at 180 degrees, 540 degrees, 900 degrees, and so on.

When the EEO is configured to generate an absolute index pulse (DRV.EMUEMODE is 2, 7, or 9) this parameter, DRV.EMUEZOFFSET and DRV.EMUETURN define the location of the Z pulse. DRV.EMUETURN is used to define which turn of the position range the Z pulse is located. DRV.EMUEZOFFSET is used to define the position of the Z pulse within one revolution. For example, if DRV.EMUETURN is set to 1, and DRV.EMUEZOFFSET is set to 32,768 (180 degrees), then the index pulse will be generated at position 540 degrees.

When the EEO is configured in pass through mode (DRV.EMUEMODE is 12, 13, or 14) the EEO Z pulse will be generated each time the encoder's physical Z pulse is generated (the physical Z pulse is "passed through").

DRV.EMUEMODE sets the EEO connector to act as either an input or output as follows.

Setting	Function
0 (recommended)	Input (see to select the type of inputs the secondary feedback will accept)
1	EEO Output, A/B with once per rev index
2	EEO Output, A/B with absolute index pulse.
3	Input, A/B signals (Deprecated)
4	Input, step and direction signals (Deprecated)
5	Input, up/down Signals (Deprecated)
6	Step/Dir with one Z-pulse/rev
7	Step/Dir with one absolute Z-pulse (depends on DRV.EMUEOFFSET and DRV.EMUETURN)
8	CW/CCW output with one Z-pulse/rev
9	CW/CCW output with one absolute Z-pulse (depends on DRV.EMUEOFFSET and DRV.EMUETURN)
10	Allows the X9 connector to be used as a General Purpose I/O or SynqNet fieldbus controlled I/O

Setting	Function
11	FB3 Input (Tertiary feedback is reported with FB3.P (→ p. 488)). Use FB3.MODE (→ p. 485) to select the feedback type.
12	Output - A/B with index pass through.
13	Output - Step/Dir with index pass through.
14	Output - CW/CCW with index pass through.
15	Output - A/B stepper control.
16	Output - Step/Dir stepper control.
17	Output - CW/CCW stepper control.

NOTE

If you are using multi-turn or single turn absolute feedback devices, and the once per rev or absolute Z pulse modes (DRV.EMUEMODES 1,2,6,7,8, or 9) the Z pulse generated by the EEO will always be aligned with the same mechanical position of the primary feedback position. If you are using an incremental feedback device and these modes, then the origin of the primary feedback is not at the same mechanical position each time the drive powers up. If you are using the pass through mode (DRV.EMUEMODES 12, 13, or 14) the Z pulse generated by the EEO will always be aligned with the same mechanical position of the primary feedback position.

Related Topics

DRV.EMUERES (→ p. 383), DRV.EMUEZOFFSET (→ p. 384), DRV.EMUEMTURN (→ p. 381)

19.10.24 DRV.EMUEMTURN

General Information	
Type	R/W Parameter
Description	Defines the location of the index pulse on the EEO (emulated encoder output) when DRV.EMUEMODE=2.
Units	revolutions
Range	0 to 4,294,967,295
Default Value	0
Data Type	Integer
Start Version	M_01-00-00-000

Fieldbus	Index/Subindex	Object Start Version
EtherCAT COE and CANopen	3491h/0	M_01-00-00-000

Description

When the emulated encoder output (EEO) is configured to generate an absolute index pulse (DRV.EMUEMODE is 2, 7 or 9) this parameter and DRV.EMUEZOFFSET define the location of the Z pulse. DRV.EMUEMTURN is used to define which turn of the position range the Z pulse is located. DRV.EMUEZOFFSET is used to define the position of the Z pulse within one revolution.

Note: If you are using multi-turn or single turn absolute feedback devices the Z pulse from generated by the EEO will always be aligned with the same mechanical position of the of the primary feedback position. If you are using an incremental feedback device then the origin of the primary feedback is not at the same mechanical position each time the drive powers up.

Related Topics

DRV.EMUEMODE (→ p. 379), DRV.EMUERES (→ p. 383)

19.10.25 DRV.EMUEPULSEWIDTH

General Information	
Type	TBD
Description	Sets the encoder output pulse width for modes 6 to 7.
Units	us(microseconds)
Range	4.08 us to 2621.48 us
Default Value	4.08 us
Data Type	Float
Start Version	M_01-00-00-000

Fieldbus	Index/Subindex	Object Start Version
EtherCAT COE and CANopen	520Dh/0	M_01-00-00-000

Description

EMU Encoder Out Pulse Width Register

Sets pulse width for CW/CCW and Step and Direction modes. This parameter does not effect the A quad B mode. To calculate emuOutPulseWidth:

$(\text{Desired pulse width} - 40 \text{ nsec}) / 520 \text{ nsec}$

Requirement		DSFPGA-03-306
Bits	Bits	Description
11:0	emuOutPulseWidth	Read/Write 12 bit unsigned number minimum resolution is 520 nsec. Reset state – 0
15:12		reserved

- Register is in counts (12 bit)
- Register * 520ns + 40ns is the actual pulse with.
- Register = 1 = pulse width is 560ns = 0.56us (minimum value)
- For each register increment the pulse width is raised by 0.52us

Example

50 usecs pulse width

$\text{emuOutPulseWidth} = (50 \text{ usecs} - 40 \text{ nsec}) / 520 \text{ nsec} = 96$

$\text{actual pulse} = 96 * 520 \text{ nsec} + 40 \text{ nsec} = 49.88 \text{ usecs}.$

Related Topics

DRV.EMUEMODE (→ p. 379)

19.10.26 DRV.EMUERES

General Information	
Type	R/W Parameter
Description	Sets the resolution of the EEO (emulated encoder output).
Units	lines/rev (when DRV.EMUEMODE (→ p. 379) = 1, 2, or 3) counts/rev (when DRV.EMUEMODE (→ p. 379) = 4 or 5)
Range	0 to 16,777,215 lines per revolution
Default Value	0 lines per revolution
Data Type	Integer
Start Version	M_01-00-00-000 (resolution increased from 65,535 to 16,777,215 in M_01-04-00-000)

Fieldbus	Index/Subindex	Object Start Version
EtherCAT COE and CANopen	3535h/0	M_01-00-00-000

Description

This parameter sets the emulated encoder (EEO) resolution. DRV.EMUERES also defines how many lines are output for one revolution of the primary feedback (when this port is configured as an output), or how many lines will be considered a full revolution of the handwheel (when this port is configured as an input).

Related Topics

DRV.EMUEMODE (→ p. 379)

19.10.27 DRV.EMUZOFFSET

General Information	
Type	R/W Parameter
Description	Sets the location of the EEO (emulated encoder output) index pulse (when DRV.EMUEMODE=1).
Units	1/65536 rev
Range	0 to 65535 rev
Default Value	0 rev
Data Type	Integer
Start Version	M_01-00-00-000

Fieldbus	Index/Subindex	Object Start Version
EtherCAT COE and CANopen	3537h/0	M_01-00-00-000

Description

When emulated encoder output (EEO) multiturn is selected (DRV.EMUEMODE (→ p. 379)=1), this parameter is used by itself to define the position of the Z pulse within one revolution. When the primary feedback position (within a revolution) equals this value, an index pulse will output. Also, if DRV.EMUEMODE=1 then this parameter is used in conjunction with DRV.EMUEMTURN.

When the EEO is configured to generate an absolute index pulse (DRV.EMUEMODE is 2, 7 or 9) this parameter and DRV.EMUZOFFSET define the location of the Z pulse. DRV.EMUEMTURN is used to define which turn of the position range the Z pulse is located and DRV.EMUZOFFSET is used to define the position of the Z pulse within one revolution.

Note: If you are using multi-turn or single turn absolute feedback devices the Z pulse from generated by the EEO will always be aligned with the same mechanical position of the of the primary feedback position. If you are using an incremental feedback device then the origin of the primary feedback is not at the same mechanical position each time the drive powers up.

Related Topics

DRV.EMUEMODE (→ p. 379), DRV.EMUEMTURN (→ p. 381)

19.10.28 DRV.EN

General Information	
Type	Command
Description	Enables the axis (software).
Units	N/A
Range	N/A
Default Value	Analog drive software is enabled. All other types of drive software are disabled.
Data Type	N/A
Start Version	M_01-00-00-000

*For Profinet, write a value of 0 into the PNU to execute a command.

Description

DRV.EN issues a software enable to the drive. You can query the value of DRV.ACTIVE (→ p. 356) to check whether the drive is currently enabled or disabled.

You can also query the value of DRV.DISSOURCES (→ p. 373) to check whether the software enable bit is high (software enabled was issued by executing DRV.EN) or the software enable bit is low (software disable was issued by executing DRV.DIS). If the drive software enable bit is low and DRV.EN is executed, then drive faults are automatically cleared during the software enable process.

Related Topics

15.3 Clearing Faults

10.3 Enable/Disable

DRV.DIS (→ p. 371), DRV.DISSOURCES (→ p. 373), DRV.ACTIVE (→ p. 356)

19.10.29 DRV.ENDEFAULT

General Information	
Type	R/W Parameter
Description	Sets the default state of the software enable.
Units	N/A
Range	0 to 1
Default Value	0
Data Type	Boolean
Start Version	M_01-00-00-000

Fieldbus	Index/Subindex	Object Start Version
EtherCAT COE and CANopen	5080h/0	M_01-00-00-000

Description

DRV. ENDEFAULT sets the default state of the software enable on power up for drives without fieldbuses (DRV.CMDSOURCE other than 1).

NOTE

It is recommended to not use this parameter with a BASIC program (keep DRV.ENDEFAULT = 0 / default value). Instead set DRV.SWENABLE = 1 at the beginning of the BASIC program.

Related Topics

Enable/Disable (→ p. 78)

19.10.30 DRV.ERRORLIST

General Information	
Type	R/O
Description	Prints a list of all possible error codes and error text.
Units	N/A
Range	N/A
Default Value	N/A
Data Type	String
Start Version	M_01-09-00-000

Description

AKD PDMM commands and parameters reports an error code when a command cannot be executed. Use DRV.ERRORLIST to print a list of all possible error codes and their descriptions.

19.10.31 DRV.FAULTDISPLAYMODE

General Information	
Type	NV Parameter
Description	Sets the fault display mode.
Units	N/A
Range	0 to 1
Default Value	0
Data Type	Integer
Start Version	M_01-13-00-000

Fieldbus Information

Fieldbus	Index/Subindex	Object Start Version
EtherCAT COE and CANopen	53C7h	M_01-13-00-000

Description

DRV.FAULTDISPLAYMODE sets the LED display behavior when faults are present.

Value	Description
0	Only the highest priority fault is displayed.
1	All faults displayed.

Related Topics

DRV.CLRFAULTS (→ p. 360), DRV.FAULTHIST (→ p. 389), DRV.CLRFAULTHIST (→ p. 359)

19.10.32 DRV.FAULTHIST

General Information	
Type	R/O Parameter
Description	Reads the last 50 faults from NV memory.
Units	N/A
Range	N/A
Default Value	N/A
Data Type	N/A
Start Version	M_01-00-00-000

Fieldbus	Index/Subindex	Object Start Version
EtherCAT COE and CANopen	2012h 2013h	M_01-00-00-000

Description

DRV.FAULTHIST returns the last 50 faults that occurred in the drive. The faults are shown with their fault number (which matches the one displayed on the drive display) and a time stamp that indicates when they last occurred.

Issue a DRV.CLRFAULTHIST (→ p. 359) to clear this fault log.

Related Topics

DRV.FAULTS (→ p. 391), DRV.CLRFAULTHIST (→ p. 359)

19.10.33 DRV.FAULT1 to DRV.FAULT10

General Information	
Type	R/O
Description	Location of fault codes for any active fault conditions.
Units	N/A
Range	Any supported fault code or 0.
Default Value	N/A
Data Type	Integer
Start Version	M_01-06-00-000

Fieldbus	Index/Subindex	Object Start Version
EtherCAT COE and CANopen	2001h/1	DRV.FAULT1
	2001h/2	DRV.FAULT2
	2001h/3	DRV.FAULT3
	2001h/4	DRV.FAULT4
	2001h/5	DRV.FAULT5
	2001h/6	DRV.FAULT6
	2001h/7	DRV.FAULT7
	2001h/8	DRV.FAULT8
	2001h/9	DRV.FAULT9
	2001h/A	DRV.FAULT10
		M_01-00-00-000

Description

These parameters are holding registers where any active faults will be kept. A value of zero represents that no fault is present. Non-zero values correspond to specific fault codes in the drive (see fault and warning messages). The registers are populated in the order of when the fault occurs (DRV.FAULT1, DRV.FAULT2, DRV.FAULT3, and so on).

Notes:

- If DRV.FAULT1 value is 0, then the drive does not have any faults.
- Only active faults are shown. This is not a fault history.
- These registers are an alternative to the string type parameter DRV.FAULTS (→ p. 391), so that field-busses and AKD BASIC users have easier access to the details of the faults in the drive.
- Warnings are not shown in the registers, only faults.

Related Topics

DRV.ACTIVE (→ p. 356) | DRV.WARNING1 to DRV.WARNING3 (→ p. 427)

19.10.34 DRV.FAULTS

General Information	
Type	R/O Parameter
Description	Reads the active faults.
Units	N/A
Range	N/A
Default Value	N/A
Data Type	N/A
Start Version	M_01-00-00-000

Description

DRV.FAULTS returns a list of all currently active faults in the system, preceded by their fault number which matches the number displayed on the drive display.

To clear the faults, either issue a DRV.CLRFAULTS or issue a DRV.DIS followed by DRV.EN.

If no active faults are in the system, then after executing DRV.CLRFAULTS the value read by DRV.FAULTS is "No faults active".

Example

```
-->DRV.FAULTS
502: Bus under voltage.
-->
```

Related Topics

DRV.CLRFAULTS (→ p. 360), DRV.FAULTHIST (→ p. 389), DRV.CLRFAULTHIST (→ p. 359)

19.10.35 DRV.HANDWHEELSRC

General Information		
Type	NV Parameter	
Description	Selects the feedback for handwheel operation.	
Units	None	
Range	2-3	
Default Value	2	
Data Type	U8	
Start Version	M_01-05-08-000	
Fieldbus	Index/Subindex	Object Start Version
EtherCAT COE and CANopen	5263h/0	M_01-05-08-000

Description

This command sets the feedback which will be used as the handwheel source. If the selected Feedback is incompatible with the selected emulated encoder mode, a warning will be displayed.

Feedback 3 is only supported on drives with model numbers similar to AKD PDMM-x-xxxxx-NBxx-xxxx and will only work with Endat 2.2 multiturn encoder.

19.10.36 DRV.HELP

General Information	
Type	R/O Parameter
Description	Reads the minimum, maximum, and default values for a specific parameter or command.
Units	N/A
Range	N/A
Default Value	N/A
Data Type	N/A
Start Version	M_01-00-00-000

Description

This parameter returns more information about a specific parameter or command.

In most cases, except special parameters, this command tells you the minimum, maximum, default, and actual value of a parameter. Exceptions are commands that do not have these values (such as DRV.EN (→ p. 385)) or information commands (such as DRV.VER (→ p. 425)).

Related Topics

Terminal (→ p. 166)

19.10.37 DRV.HELPALL

General Information	
Type	R/O Parameter
Description	Retrieves the minimum, maximum, default, and actual values for all available parameters and commands.
Units	N/A
Range	N/A
Default Value	N/A
Data Type	N/A
Start Version	M_01-00-00-000

Description

This parameter retrieves all information about all parameters and commands in the firmware. In most cases, DRV.HELPALL returns the minimum, maximum, default, and actual value for each parameter and command. Exceptions include parameters and commands that do not have these values (such as DRV.EN (→ p. 385)) or pure INFO commands (such as DRV.VER (→ p. 425)).

Related Topics

Terminal (→ p. 166)

19.10.38 DRV.HWENABLE

General Information	
Type	R/O
Description	Status of the hardware enable.
Units	N/A
Range	0 to 1
Default Value	N/A
Data Type	Integer
Start Version	tbd

Description

Status of the Hardware Enable.

0 - not enabled

1 - enabled

Notes: This parameter reflects the status of the hardware enable only, not if the status of the power stage. The status of the power stage enable is determined by DRV.ACTIVE.

Related Topics

DRV.DISSOURCES (→ p. 373) | DRV.ACTIVE

19.10.39 DRV.HWENDELAY

General Information	
Type	NV Parameter
Description	Delay time between inactive Hardware Enable input and drive disable.
Units	Milliseconds
Range	0 to 167 ms
Default Value	0 ms
Data Type	Integer
Start Version	01-05-08-000

Fieldbus	Index/Subindex	Object Start Version
EtherCAT COE and CANopen	5264h/0	M_01-05-08-000

Description

By default, when the Hardware Disable input deactivates, the drive is immediately disabled. However, on a vertical axis this may allow the load to drop slightly before the brake is applied.

To ensure that the brake is applied before the power stage is disabled, set DRV.HWENDELAY to a value which allows the brake to apply fully.

While the brake is applying, the drive will also attempt to decelerate the motor using the standard drive disable settings such as DRV.DISMODE, CS.DEC, CS.VTHRESH and CS.TO.

NOTE

Prior to version 01-05-08-000, the brake would only apply when velocity dropped below CS.VTHRESH or MOTOR.TBRAKETO expired. Starting with 01-05-08-000, the brake will now apply immediately when the Hardware Enable Input line is deactivated.

Related Topics

DRV.DISMODE (→ p. 372) | CS.DEC (→ p. 314) | CS.VTHRESH (→ p. 317) | CS.TO (→ p. 316) | MOTOR.TBRAKEAPP (→ p. 604)

19.10.40 DRV.HWENMODE

General Information	
Type	R/W Parameter
Description	Selects the action that the hardware enable digital input will perform.
Units	N/A
Range	0 to 1
Default Value	0
Data Type	Integer
Start Version	M_01-03-00-000

Fieldbus	Index/Subindex	Object Start Version
EtherCAT COE and CANopen	3506h/0	M_01-03-00-000

Description

This parameter selects the action that the hardware enable digital input will perform.

0 = The rising edge of the hardware enable will clear the drive faults.

1 = The rising edge of the hardware enable will not clear the drive faults.

The high/low state of the hardware enable is always used to control the active enable state of the drive.

Related Topics

10.3 Enable/Disable

19.10.41 DRV.ICONT

General Information	
Type	R/O Parameter
Description	Reads the continuous rated current value.
Units	Arms
Range	N/A
Default Value	N/A
Data Type	Float
Start Version	M_01-00-00-000

Fieldbus	Index/Subindex	Object Start Version
EtherCAT COE and CANopen	5083h/0	M_01-00-00-000

Description

DRV.ICONT returns the drive continuous rated current in Arms.

Related Topics

DRV.IPEAK (→ p. 401)

19.10.42 DRV.INFO

General Information	
Type	R/O Parameter
Description	Reads general information about the drive.
Units	N/A
Range	N/A
Default Value	N/A
Data Type	String
Start Version	M_01-00-00-000

Description

DRV.INFO returns general information about the drive.

Example

```
Advanced Kollmorgen Drive
```

```
-----
```

```
Drive model : AKD PDMM-P00306-NACC-0000
```

```
Drive type : Position Indexer
```

```
Continuous current : 3.000 Arms
```

```
Peak current: 9.000 Arms
```

```
Voltage : 120/240 VAC
```

```
Option Board : Not applicable
```

```
Connectivity : EtherCAT
```

```
Product serial number: R-0939-00048
```

```
Hardware version : --
```

```
Mac address: 00-23-1B-00-50-F1
```

```
Processor ID: 0xE5040003
```

```
Firmware version: M_01-04-16-000_Z_2011-09-12_14-03-45_AP
```

```
Operational image : M_01-04-16-000_Z_2011-09-12_14-03-45_AP
```

```
Resident image : R_00-00-28-000
```

```
Revision : 19074
```

```
Source Location: local
```

```
FPGA Version: FP0003_0103_00_00
```

```
Operational image : FP0003_0103_00_00
```

Resident image : FPB003_0100_00_00

Size: 1600

Control board serial number : 4-0921-00196

Part number : 0

Revision : 7

Board ID : Standard

Power board serial number : 4-0922-00156

Part number : 0

TCP/IP IP address : 169.254.250.241

Subnet mask : 255.255.0.0

Default gateway : 0.0.0.0

DHCP server : 0.0.0.0

Temporary fieldbus type : EtherCAT

FPGA size : 1600

19.10.43 DRV.IPEAK

General Information	
Type	R/O Parameter
Description	Reads the peak rated current value.
Units	Arms
Range	N/A
Default Value	N/A
Data Type	Float
Start Version	M_01-00-00-000

Fieldbus	Index/Subindex	Object Start Version
EtherCAT COE and CANopen	5084h/0	M_01-00-00-000

Description

DRV.IPEAK returns the drive peak rated current in Arms.

Related Topics

7.5 Foldback

DRV.ICONT (→ p. 398)

19.10.44 DRV.IZERO

General Information	
Type	NV Parameter
Description	Sets the current that will be used during the DRV.ZERO procedure.
Units	Arms
Range	Drive peak current to 0 Arms
Default Value	0 Arms
Data Type	Float
Start Version	M_01-00-00-000

Fieldbus	Index/Subindex	Object Start Version
EtherCAT COE and CANopen	5085h/0	M_01-00-00-000

Description

This parameter sets the current that is used during the DRV.ZERO (→ p. 429) procedure.

Related Topics

DRV.ZERO (→ p. 429)

19.10.45 DRV.LIST

General Information	
Type	R/O Parameter
Description	Reads the list of available parameters and commands.
Units	N/A
Range	N/A
Default Value	N/A
Data Type	String
Start Version	M_01-00-00-000

Description

DRV.LIST reads the list of available commands and parameters from the drive.

To filter this list, enter DRV.LIST followed by the prefix of the commands and parameters that you wish to display.

Example

Return a list of all available commands in the system:

```
-->DRV.LIST
```

Return all commands with the prefix DRV:

```
-->DRV.LIST DRV
```

19.10.46 DRV.LOGICVOLTS

General Information	
Type	R/O Parameter
Description	Reads the logic voltages.
Units	mv , Ω
Range	N/A
Default Value	N/A
Data Type	String
Start Version	M_01-00-00-000

Description

DRV.LOGICVOLTS reads the logic voltages data of 1.2 V, 2.5 V, 3.3 V, 5 V, 12 V, -12 V, and 3.3 AV.

Example

Below is an example of the output for this command:

```

ch0 = 1.2V      : 1211 mv
ch1 = 2.5V      :2488 mv
ch2 = 3.3V      :3274 mv
ch3 = 5V        :4950 mv
ch4 = 12V       :11892 mv
ch5 = -12V      : -11912 mv
ch6 = 3.3AV     :3300 mv
ch7 = R ohm     :100000 ohm

```

19.10.47 DRV.MEMADDR

General Information	
Type	R/W Parameter
Description	Sets the read and write address.
Units	N/A
Range	N/A
Default Value	U8
Data Type	N/A
Start Version	M_01-00-00-000

Description

DRV.MEMADDR sets the address that is used by DRV.MEMDATA. The input can be either an internal parameter of the drive or any direct address from the DSP address space (SDRAM, internal RAM, or asynchronous memory). The input value can be either decimal or hexadecimal with 0x prefix.

Type extension can be one of the following:

U8,S8,U16,S16,U32,S32,U64,S64.

Examples

Setting to an internal parameter:

```
-->DRV.MEMADDR CCommandHandler.Debug1
```

Setting to an internal address:

```
-->DRV.MEMADDR 0xffabcde.u16
```

Related Topics

DRV.MEMDATA (→ p. 406)

19.10.48 DRV.MEMDATA

General Information	
Type	R/W Parameter
Description	Sets or reads a value from an internal address.
Units	N/A
Range	N/A
Default Value	N/A
Data Type	N/A
Start Version	M_01-00-00-000

Description

DRV.MEMDATA reads a value from the address that was set by DRV.MEMADDR (→ p. 405) or writes a value to this address. The input value can be either decimal or hexadecimal with 0x prefix.

Examples

Read a value from internal address:

```
-->DRV.MEMDATA 01
```

Write a hexadecimal value to an internal address:

```
-->DRV.MEMADDR 0x01
```

Related Topics

DRV.MEMADDR (→ p. 405)

19.10.49 DRV.MOTIONDISSOURCES

General Information	
Type	R/O Parameter
Description	Returns some causes of a motion disable.
Units	N/A
Range	N/A
Default Value	N/A
Data Type	Integer
Start Version	M_01-10-03-000

Description

This parameter reports some of the reasons that motion may not be allowed on the axis. There are additional reasons why the drive cannot accept a motion command that are not reported by this command (for example, fieldbus control bits or fault status).

Value	Description
0	Motion not blocked by reason indicated for value 1, 2, or 3.
1	Suspend Motion Active
2	Brake not released
4	Brake not released
8	Rotor flux not ready

Related Topics

Digital Inputs and Outputs (pg 1)

19.10.50 DRV.NAME

General Information	
Type	NV Parameter
Description	Sets and reads the name of the drive.
Units	N/A
Range	N/A
Default Value	No-Name
Data Type	String
Start Version	M_01-00-00-000

Fieldbus	Index/Subindex	Object Start Version
EtherCAT COE and CANopen	2031h/0	M_01-00-00-000

Description

You can assign a unique name to any drive under the following conditions:

- Only use ASCII characters
- Max length of 10 characters
- No spaces in name

This name is one way to identify the drive in a multiple drive network (for instance, in a TCP/IP network on which multiple drives reside).

From the terminal screen, DRV.NAME returns the name of the drive as ASCII characters.

19.10.51 DRV.NVCHECK

General Information	
Type	R/O Parameter
Description	NV Parameter Checksum
Units	None
Range	N/A
Default Value	N/A
Data Type	Integer
Start Version	M_01-04-12-000

Fieldbus	Index/Subindex	Object Start Version
EtherCAT COE and CANopen	2019h/0	M_01-04-12-000

Description

DRV.NVCHECK returns a checksum of all the drives NV parameters. This parameter can be used to detect changes in parameters.

In some applications a master device needs to confirm the AKD PDMM drive contains an expected set of drive parameters. Reading and checking all the drive parameters individually is viable but this would be a long process involving many reads over the network. DRV.NVCHECK is a checksum on all the NV parameters and this parameter can be read in a single transaction. DRV.NVCHECK will return the same number if all the drive parameters match. If any of the drive parameters are changed then DRV.NVCHECK will return a different value.

Related Topics

DRV.NVLIST (→ p. 410)

19.10.52 DRV.NVLIST

General Information	
Type	R/O Parameter
Description	Lists the NV parameters and values from the RAM.
Units	N/A
Range	N/A
Default Value	N/A
Data Type	N/A
Start Version	M_01-00-00-000

Description

DRV.NVLIST lists all the drive parameters that reside in NV memory.

The list includes each parameter name, followed by its current value from the RAM.

19.10.53 DRV.NVLOAD

General Information	
Type	R/O Parameter
Description	Loads all data from the NV memory of the drive into the RAM parameters.
Units	N/A
Range	N/A
Default Value	N/A
Data Type	N/A
Start Version	M_01-00-00-000

*For Profinet, write a value of 0 into the PNU to execute a command.

Description

DRV.NVLOAD loads all data from the NV memory of the drive into the RAM parameters.

Related Topics

DRV.NVLOAD , DRV.NVLIST (→ p. 410)

19.10.54 DRV.NVSAVE

General Information	
Type	Command
Description	Saves the drive parameters from the RAM to the NV memory.
Units	N/A
Range	N/A
Default Value	N/A
Data Type	N/A
Start Version	M_01-00-00-000

Fieldbus	Index/Subindex	Object Start Version
EtherCAT COE and CANopen	35EBh/0	M_01-00-00-000

*For Profinet, write a value of 0 into the PNU to execute a command.

Description

DRV.NVSAVE saves the current drive parameter values from the RAM to the NV memory.

The drive parameters that were saved to the NV are read from the NV on the next drive boot, causing the values to be automatically set to the saved values on every drive boot.

Executing DRV.RSTVAR does not modify the values of the NV, but instead sets the drive values in RAM to their defaults.

Related Topics

DRV.RSTVAR (→ p. 417)

19.10.55 DRV.ONTIME

General Information	
Type	R/O Parameter
Description	Returns how long the drive has been running since last power up.
Units	Days:Hours:Minutes:Seconds
Range	N/A
Default Value	N/A
Data Type	String
Start Version	M_01-00-00-000

Description

This parameter returns the length of time that the drive has been running for the current session (since the last power up).

Related Topics

Returns how long the drive has been running since first activated. (→ p. 418)

19.10.56 DRV.OPMODE

General Information	
Type	NV Parameter
Description	Sets the drive operation mode (current, velocity, or position).
Units	N/A
Range	0 to 2
Default Value	0
Data Type	Integer
Start Version	M_01-00-00-000

Fieldbus	Index/Subindex	Object Start Version
EtherCAT COE and CANopen	35B4h/0	M_01-00-00-000

Description

DRV.OPMODE specifies the operation mode of the drive. You must also use DRV.CMDSOURCE to set the source of the command to the drive.

The operation mode values can be set as follows:

Mode	Description
0	Current (torque) operation mode
1	Velocity operation mode
2	Position operation mode

DRV.OPMODE can be changed while the drive is enabled or disabled. If you are using the terminal to change the operation mode, then it is recommended that you disable the drive before changing the operation mode. If you change the operation mode from the terminal while the drive is enabled, the system may experience a step change in demand.

Example

Set the source of the command to a TCP/IP channel and the desired operation mode to velocity:

```
-->DRV.CMDSOURCE 0
-->DRV.OPMODE 1
```

Related Topics

10.4 Controlled Stop

1 Current Loop

1 Velocity Loop

1 Position Loop

DRV.CMDSOURCE (→ p. 362)

19.10.57 DRV.READFORMAT

General Information	
Type	R/W Parameter
Description	Sets the value returned to either decimal or hexadecimal.
Units	N/A
Range	10 or 16
Default Value	10
Data Type	Integer
Start Version	M_01-00-00-000

Description

DRV.READFORMAT sets the return values type to either decimal or hexadecimal.

Format	Description
10	Sets the read values to decimal format
16	Sets the read values to hexadecimal format

19.10.58 DRV.REBOOT

General Information	
Type	Command
Description	Performs a software reboot.
Units	N/A
Range	N/A
Default Value	N/A
Data Type	Integer
Start Version	M_01-13-08-000

Description

This parameter performs a software reboot when the following command is issued in the EWV¹ terminal:

```
DRV.REBOOT 0xAABBCCDD
```

EWV will disconnect from the AKD PDMM when the reboot command is executed. The AKD PDMM can be reconnected to EWV approximately one minute after the reboot command is issued. The parameters stored in non-volatile memory will be restored to the AKD PDMM once rebooted.

¹Embedded Workbench Views

19.10.59 DRV.RSTVAR

General Information	
Type	Command
Description	Sets default values in the drive without re-booting the drive and without resetting the NV memory.
Units	N/A
Range	N/A
Default Value	N/A
Data Type	N/A
Start Version	M_01-00-00-000

7

Fieldbus	Index/Subindex	Object Start Version
EtherCAT COE and CANopen	1011h/1	M_01-00-00-000

*For Profinet, write a value of 0 into the PNU to execute a command.

Description

DRV.RSTVAR causes the drive to return to the default values without the need to re-boot the drive first and without resetting the NV memory. Use DRV.RSTVAR to return to the default settings and recover a working drive.

19.10.60 DRV.RUNTIME

General Information	
Type	R/O Parameter
Description	Returns how long the drive has been running since first activated.
Units	Days:Hours:Minutes:Seconds
Range	N/A
Default Value	N/A
Data Type	String
Start Version	M_01-00-00-000

Fieldbus	Index/Subindex	Object Start Version
EtherCAT COE and CANopen	2011h	M_01-00-00-000

Description

DRV.RUNTIME returns the length of time that the drive has been running since it was first activated. This time includes the current session and the total amount of time from all previous sessions.

19.10.61 DRV.SETUPREQBITS

General Information	
Type	R/O Parameter
Description	Reads the bitwise set status of parameters that must be set before the drive can be enabled.
Units	N/A
Range	N/A
Default Value	N/A
Data Type	N/A
Start Version	M_01-00-00-000

Description

This parameter returns the bitwise set status of parameters that needs to be set up before the drive can be enabled. The drive can only be enabled when this parameter returns 0.

NOTE

If MOTOR.AUTOSSET (→ p. 574) is set to 1 (parameters automatically calculated from motor ID data), then all values in the list will be initialized from the feedback device. Otherwise, the parameters must be set manually.

The following table lists the parameters which require setup for each motor type.

Parameter	Bit	Default Value	Linear Permanent Magnet	Induction Motor V/f Open Loop	Induction Motor Closed Loop	Interior Permanent Magnet	Brush Motor
IL.KP	0	50 [V/A]	√	-	√	√	√
MOTOR.IPEAK	1	2 Arms	√	√	√	√	√
MOTOR.ICONT	2	1 Arms	√	√	√	√	√
MOTOR.POLES	4	6	√	√	√	√	-
MOTOR.LQLL	7	17mH	-	-	-	√	-
MOTOR.LDLL	8	17mH	-	-	-	√	-
MOTOR.KE	9	0	-	-	-	√	-
MOTOR.IMTR	10	100ms	-	-	√	-	-
MOTOR.IMID	11	0	-	-	√	-	-
MOTOR.VOLTRATED	12	230 Vrms	-	√	-	-	-
MOTOR.VRATED	13	0	-	-	-	√	-
MOTOR.LISAT	14	25 x DRIVE.IPEAK	-	-	-	√	-
MOTOR.VRIDK1	15	0	-	-	-	√	-
MOTOR.VRIDK2	16	0	-	-	-	√	-
MOTOR.IDMAX	17	0.5 x MOTOR.IPEAK	-	-	-	√	-
IL.KDPRATIO	18	1	-	-	-	√	-
MOTOR.PITCH	19	32	√	-	-	-	-

Parameter	Bit	Default Value	Linear Per- manent Magnet	Induction Motor V/f Open Loop	Induction Motor Closed Loop	Interior Permanent Magnet	Brush Motor
MOTOR.VOLTMAX	20	480 Vrms	-	-	-	√	√

Related Topics

DRV.SETUPREQLIST (→ p. 421), MOTOR.AUTOSET (→ p. 574)

19.10.62 DRV.SETUPREQLIST

General Information	
Type	R/O Parameters
Description	Reads the list of parameters that must be set before the drive can be enabled.
Units	N/A
Range	N/A
Default Value	N/A
Data Type	N/A
Start Version	M_01-00-00-000

Description

This parameter returns the list of parameters that must be set before the drive can be enabled and also whether or not each one of those parameters is set. This list of parameters will vary depending on the value MOTOR.TYPE. The drive can only be enabled when all commands have a value of 0.

NOTE

If MOTOR.AUTOSET (→ p. 574) is set to 1 (parameters automatically calculated from motor ID data), then all values in the list will be initialized from the feedback device. Otherwise, the parameters must be set manually.

Example

```
-->DRV.SETUPREQLIST
IL.KP 0
MOTOR.ICONT 0
MOTOR.IPEAK 0
MOTOR.POLES 0
-->
```

Related Topics

DRV.SETUPREQBITS (→ p. 419), MOTOR.AUTOSET (→ p. 574)

19.10.63 DRV.STOP

General Information	
Type	Command
Description	This command stops all drive motion.
Units	N/A
Range	N/A
Default Value	N/A
Data Type	N/A
Start Version	M_01-00-00-000

Fieldbus	Index/Subindex	Object Start Version
EtherCAT COE and CANopen	35FEh/0	M_01-00-00-000

*For Profinet, write a value of 0 into the PNU to execute a command.

Description

This command stops drive motion. In torque and velocity modes, the command value will immediately be set to 0. In position mode, the axis will decelerate to a full stop. If the position command is from a gearing master, the drive will cancel gearing and decelerate to a stop. This command has no effect if the command source is an analog input (Analog Position, Analog Velocity, or Analog Torque).

If the command values are coming from a fieldbus master, the stop may be immediately overwritten by a new fieldbus command. Use a controlled stop input or disable command to ensure a stop.

19.10.64 DRV.TEMPERATURES

General Information	
Type	R/O Parameter
Description	Reads the temperature of drive components.
Units	°C
Range	55 to 125 °C
Default Value	N/A
Data Type	String
Start Version	M_01-00-00-000

Fieldbus	Index/Subindex	Object Start Version
EtherCAT COE and CANopen	3610h/0 3611h/0	M_01-00-00-000

Description

DRV.TEMPERATURES reads the temperature in different parts of the drive (power and control boards). The temperature is read from temperature sensors located in the drive.

Example

Below is an example of the output for this command :

```
Control Temperature: 39 °C
Power1 Temperature: 31 °C
Power2 Temperature: Sensor does not exist.
Power3 Temperature: Sensor does not exist.
```

19.10.65 DRV.TYPE

General Information	
Type	R/W on the CC drive model. R/O on all other drive models.
Description	Selects the operational fieldbus on CC drive models.
Units	N/A
Range	0 to 8
Default Value	2
Data Type	Integer
Start Version	M_01-03-00-000

Description

DRV.TYPE allows you to select the operational fieldbus for your drive. This parameter is read-write on the CC drive models and read-only on all other drive models. To change the operational fieldbus of your drive:

1. Set DRV.TYPE to one of the following values. Only values 0 to 3 are selectable. All other values are read only.
 - 0 = Analog (no EtherCAT or CANopen) with no position indexer functionality.
 - 1 = Analog (no EtherCAT or CANopen) with position indexer functionality.
 - 2 = EtherCAT
 - 3 = CANopen
 - 4 = SynqNet
 - 5 = EtherNet/IP
 - 6 = BASIC Language (not fieldbus)
 - 7 = Profinet
 - 8 = sercos[®] III
2. Save the parameters to the NV memory on the drive by issuing the DRV.NVSAVE command
3. Power cycle the 24 V supply to the drive. When the drive has finished powering up, it will be working with the new selection.

Changing DRV.TYPE does not immediately change the type of the drive fieldbus selection. You must power cycle the drive to start the drive with the selected functionality.

You cannot use EtherCAT and CANopen at the same time. Use FBUS.TYPE or DRV.INFO to identify the fieldbus currently in use.

DRV.TYPE does not change if you use DRV.RSTVAR.

Related Topics

AKD PDMM Models (→ p. 27)

FBUS.TYPE (→ p. 507), DRV.INFO (→ p. 399)

19.10.66 DRV.VER

General Information	
Type	R/O Parameter
Description	Reads the drive version.
Units	N/A
Range	N/A
Default Value	N/A
Data Type	String
Start Version	M_01-00-00-000

Description

DRV.VER reads both FPGA and firmware versions.

The version data presented is hard coded in the firmware code.

Example

Below is an example of the output for this command:

```
Danaher Motion - Digital Servo Drive
-----
FPGA version : FP0004_0001_00_07
Firmware Version : M_0-0-15_T_2009-01-19_10-36-28_IR
```

19.10.67 DRV.VERIMAGE

General Information	
Type	R/O Parameter
Description	Returns the version data from each image.
Units	N/A
Range	N/A
Default Value	N/A
Data Type	String
Start Version	M_01-00-00-000

Description

DRV.VERIMAGE reads the versions of the different images in the drive. This parameter returns the version data from each image .i00 file.

Example

Below is an example of the output for this parameter:

```
Danaher Motion - Digital Servo Drive
-----
Resident Firmware: R_0-0-11
Operational Firmware: M_0-0-15
Resident FPGA: FPB004_0001_00_07
Operational FPGA : FP0004_0001_00_07
```

19.10.68 DRV.WARNING1 to DRV.WARNING3

General Information	
Type	R/O
Description	Location of fault codes for any active warning conditions.
Units	N/A
Range	Any supported fault code or 0
Default Value	N/A
Data Type	Integer
Start Version	

Fieldbus	Index/Subindex		Object Start Version
EtherCAT COE and CANopen	2000h/1	DRV.WARNING1	M_01-00-00-000
	2000h/2	DRV.WARNING2	
	2000h/3	DRV.WARNING3	

Description

These parameters are holding registers where any active warnings will be displayed. A value of zero represents that no warning is present. Non-zero values correspond to specific warning codes in the drive (see fault and warning messages). The registers are populated in the order of when the warning occurs (DRV.WARNING1, DRV.WARNING2, DRV.WARNING3, and so on).

Notes:

- If DRV.WARNING1 value is 0, then the drive does not have any faults.
- Only active warnings are shown. This is not a warning history.
- These registers are an alternative to the string type parameter DRV.WARNINGS so that field-buses and AKD BASIC user programs have integer-type parameters to access to the details of the warnings in the drive.
- Faults are not shown in the registers, only warnings.

Related Topics

DRV.FAULT1 to DRV.FAULT10 (→ p. 390) |

19.10.69 DRV.WARNINGS

General Information	
Type	R/O Parameter
Description	Reads the active warnings.
Units	N/A
Range	N/A
Default Value	N/A
Data Type	N/A
Start Version	M_01-00-00-000

Description

DRV.WARNINGS returns a list of all currently active warnings in the system.

19.10.70 DRV.ZERO

General Information	
Type	R/W Parameter
Description	Sets the zero mode. The procedure is activated when the drive is enabled.
Units	N/A
Range	0 to 1
Default Value	0
Data Type	Integer
Start Version	M_01-00-00-000

Description

The zero procedure is a sequence in which phase commutation is initialized. During this procedure, the motor is held at a certain known electrical position (by applying a current defined by DRV.IZERO (→ p. 402)). After the motor rests at this position, the commutation angle is calculated and set automatically.

Related Topics

DRV.IZERO (→ p. 402)

19.11 FAULT Parameters

This section describes the FAULT parameters.

19.11.1 FAULTx.ACTION	431
19.11.2 FAULT176.ACTION, FAULT178.ACTION	432
19.11.3 FAULT570.ACTION	433

19.11.1 FAULTx.ACTION

General Information	
Type	R/W
Description	Gets/Sets the Fault Action for Fault 130, 131, 132, 134, 139, 451, and 702.
Units	N/A
Range	0 to 1
Default Value	0
Data Type	Integer
Start Version	M_01-04-16-000

Fieldbus	Index/Subindex		Object Start Version
EtherCAT COE and CANopen	5259h/0	FAULT130.ACTION	M_01-04-16-000
	525Ah/0	FAULT131.ACTION	
	525Bh/0	FAULT132.ACTION	
	525Ch/0	FAULT134.ACTION	
	5267h/0	FAULT451.ACTION	
	525Dh/0	FAULT702.ACTION	

Description

This Parameter determines the action the drive should take when Fault 130, 131, 132, 134, 139, 451, or 702 occurs.

Parameter Value	Drive Action
0	Disable Amplifier
1	Ignore (fault will not be reported)

19.11.2 FAULT176.ACTION, FAULT178.ACTION

General Information	
Type	R/W Parameter
Description	Gets/Sets the fault action for either fault 176 or 178.
Units	N/A
Range	0, 1, 4
Default Value	0
Data Type	Integer
Start Version	M_01-013-00-000

Description

These parameters set the action performed when F176 (→ p. 180) or F178 (→ p. 181) occurs.

Value	Action
0	Generate Fault
1	Ignore
4	Generate warning

Related Topics

Fault and Warning Messages (→ p. 174)

19.11.3 FAULT570.ACTION

General Information	
Type	R/W Parameter
Description	Gets/Sets the fault action for fault 570.
Units	N/A
Range	0, 1, 4
Default Value	4
Data Type	Integer
Start Version	M_01-013-00-000

Variants Supported

Supported on all HV48 drive types.

Description

This parameter sets the action performed when F570 (→ p. 190) occurs.

Value	Action
0	Generate Fault
1	Ignore
4	Generate warning

Related Topics

Fault and Warning Messages (→ p. 174)

19.12 FB1 Parameters

This section describes the FB1 parameters.

19.12.1 FB1.BISSBITS	436
19.12.2 FB1.CALTHRESH	437
19.12.3 FB1.DIAG	438
19.12.4 FB1.ENCRESES	439
19.12.5 FB1.EXTENDEDMULTITURN	440
19.12.6 FB1.FAULTS	441
19.12.7 FB1.HALLSTATE	443
19.12.8 FB1.HALLSTATEU	445
19.12.9 FB1.HALLSTATEV	446
19.12.10 FB1.HALLSTATEW	447
19.12.11 FB1.IDENTIFIED	448
19.12.12 FB1.INITPSAVED	449
19.12.13 FB1.INITPSTATUS	450
19.12.14 FB1.INITPWINDOW	451
19.12.15 FB1.INITSIGNED	452
19.12.16 FB1.LASTIDENTIFIED	453
19.12.17 FB1.MECHPOS	454
19.12.18 FB1.MEMVER	455
19.12.19 FB1.MOTORPHASE	456
19.12.20 FB1.MOTORPOLES	457
19.12.21 FB1.OFFSET	458
19.12.22 FB1.ORIGIN	459
19.12.23 FB1.P	461
19.12.24 FB1.PDIR	462
19.12.25 FB1.PFIND	463
19.12.26 FB1.PFINDCMDU	464
19.12.27 FB1.PIN	465
19.12.28 FB1.POFFSET	466
19.12.29 FB1.POLES	467
19.12.30 FB1.POUT	468
19.12.31 FB1.PSCALE	469
19.12.32 FB1.PUNIT	470

19.12.33 FB1.RESKTR	471
19.12.34 FB1.RESREFPHASE	472
19.12.35 FB1.SELECT	473
19.12.36 FB1.TRACKINGCAL	475
19.12.37 u	476
19.12.38 FB1.USERDWORD0 to FB1.USERDWORD1	478
19.12.39 FB1.USERWORD0 to FB1.USERWORD3	480

19.12.1 FB1.BISSBITS

General Information	
Type	NV Parameter
Description	Specifies the number of Biss Sensor (Position) Bits for the BiSS Mode C encoder in use.
Units	bits
Range	0 to 64 bits
Default Value	32 bits
Data Type	Integer
See Also	FB1.SELECT (→ p. 473), FB1.IDENTIFIED (→ p. 448)
Start Version	M_01-01-00-100 and M_01-01-03-000

Fieldbus	Index/Subindex	Object Start Version
EtherCAT COE and CANopen	508Ch/0	M_01-00-00-000

Description

FB1.BISSBITS specifies the number of BiSS sensor (position) bits for the BiSS Mode C encoder in use. Typically the value is either 26 or 32 for a BiSS Mode C Renishaw encoder. The required value for this parameter is provided by the feedback device manufacturer for the particular device being used.

Related Topics

Feedback 1 (→ p. 56)

19.12.2 FB1.CALTHRESH

General Information	
Type	NV Parameter
Description	Sets the velocity threshold at which the auto-calibration function will continuously update error correction for sin/cos encoders.
Units	Depends on UNIT.VROTARY (→ p. 1) or UNIT.VLINEAR (→ p. 1) Rotary: rpm, rps, deg/s, (custom units)/s, rad/s Linear: counts/s, mm/s, μm/s, (custom units)/s
Range	0 to maximum velocity
Default Value	117.000 rpm
Data Type	Float
Start Version	M_01-05-11-000

Description

FB1.CALTHRESH sets the velocity threshold at which the auto-calibration function will continuously update error correction for sin/cos encoders.

Related Topics

Feedback 1 (→ p. 56)

19.12.3 FB1.DIAG

General Information	
Type	R/O
Description	Returns feedback diagnostic information.
Units	N/A
Range	N/A
Default Value	N/A
Data Type	String
Start Version	M_01-08-00-006

Description

Some fault documentation may reference this keyword to collect additional information. The results of this keyword vary for each situation.

If you have been directed to use this keyword, please collect the results and contact Kollmorgen support for the next steps in resolving your problem.

Related Topics

FB1.FAULTS (→ p. 441)

19.12.4 FB1.ENCRES

General Information	
Type	Depends on FB1.IDENTIFIED. See table in description below.
Description	Sets the resolution of the motor encoder.
Units	Encoder counts
Range	0 to $2^{32}-1$
Default Value	1,024
Data Type	Integer
See Also	N/A
Start Version	M_01-00-00-000

Fieldbus	Index/Subindex	Object Start Version
EtherCAT COE and CANopen	3533h/0	M_01-00-00-000

Description

This parameter sets or gets the resolution of the motor encoder (encoder feedback systems only) in number of counts per revolution for a rotary motor and the number of encoder pitches per motor pole pitch for a linear motor. The number of encoder counts per revolution is obtained by multiplying the motor catalog resolution in units of PPR by four. For example, for a 1024 PPR resolution motor, the number of encoder counts per revolution is $1024*4 = 4096$. For this motor FB1.ENCRES must be set to 4096.

For linear motors, the value of FB1.ENCRES is set to the number of encoder pitches per motor pole pitch. For a motor with 32 mm pole pitch, and a 40 μm encoder pitch, the value for FB1.ENCRES should be set to $32 \text{ mm}/40 \mu\text{m} = 800$.

Depending on the value of FB1.IDENTIFIED, FB1.ENCRES changes between read-only and read-write. The following table lists the FB1.IDENTIFIED values and FB1.ENCRES's corresponding type.

FB1.IDENTIFIED value	FB1.ENCRES type
10 (Incremental encoder)	R/W
11 (Incremental encoder, no halls)	R/W
20 (Sine encoder)	R/W
21 (Sine encoder, no halls)	R/W
30 (Endat 2.1)	R/O
31 (Endat 2.2)	R/O
32 (biSS)	R/O
33 (hiperface)	R/O
34 (biSS Mode C)	R/W
40 (Resolver)	R/W
41 (sfd)	R/O
42 (Tamagawa)	R/O

Related Topics

7.2 Feedback 1

19.12.5 FB1.EXTENDEDMULTITURN

General Information	
Type	R/W
Description	Enables saving of the extended multiturn position.
Units	N/A
Range	0 to 1
Default Value	0
Data Type	Integer
Start Version	M_01-013-08-000

Description

This parameter allows additional multiturn information to be stored in non-volatile memory and restored on power up.

Related Topics

Extended Multiturn (→ p. 59)

19.12.6 FB1.FAULTS

General Information	
Type	R/O
Description	Returns a string describing the root cause of Fault 467.
Units	N/A
Range	N/A
Default Value	N/A
Data Type	String
Start Version	M_01-08-00-006

Description

Use this parameter to determine the root cause of feedback fault 467. This parameter can currently be used to diagnose faults on Hiperface DSL or SFD3 feedback types. FB1.FAULTS will return one of the following strings as a root cause for fault 467.

Hiperface DSL Strings
1000: A log reset was carried out
1001: Acceleration overrun, position invalid
1002: Test in process
1004: Internal error with angle tracking, position invalid
1005: Internal error with vector length, position invalid
1006: Internal error with position counter, position invalid
1007: Internal error with position synchronization, position invalid
1010: Error in absolute position with one rotation
1011: Error 1 in absolute position with multiple rotations
1012: Error 2 in absolute position with multiple rotations
1013: Error 3 in absolute position with multiple rotations
1020: Power on self-test done (only safety-version)
1021: Warning safety-parameter: error has been rectified (only safety-version)
1022: Error safety-parameter: error could not be rectified (only safety-version)
1023: Error calibration-data
1024: Internal communication error 1
1025: Internal communication error 2
1026: Internal general error
1030: Critical temperature
1031: Critical LED current
1032: Critical supply voltage
1033: Critical speed
1035: Critical overrun
1036: Internal checking error
1040: Invalid argument input during resources access
1041: Resources access refused due to incorrect access level

Hiperface DSL Strings
1042: Internal error on resources access
1043: Error on access to user file
1100: No link
1101: No sync
1102: Fault in short command
1103: No FPGA support
1105: Long command read timeout
1106: Long command poll timeout
1107: Spinlock timeout
1110: Long command failure (Refer to FB1.DIAG (→ p. 438) if Fault 1110 is returned)
1111: Resource ID timeout

SFD3 Strings
2100: Receive CRC Fault
2102: Communications Fault

Related Topics

FB1.DIAG (→ p. 438)

19.12.7 FB1.HALLSTATE

General Information	
Type	R/O Parameter
Description	Reads the Hall switch values (encoder feedback only).
Units	Terminal: Binary Scope: N/A
Range	Terminal: 0 0 0 to 1 1 1 Scope: 0 to 7
Default Value	N/A
Data Type	Terminal: String Scope: Integer
Start Version	M_01-00-00-000

Description

FB1.HALLSTATE reads the Hall switch values (encoder feedback only).

Terminal:

When called from the terminal, FB1.HALLSTATE will return three numbers from 0 0 0 to 1 1 1, where:

- Hall U = Digit 1
- Hall V = Digit 2
- Hall W = Digit 3

0 is a low voltage state, and 1 is a high voltage state on the hall effect.

Scope:

When viewing FB1.HALLSTATE from the scope screen, the result is a single integer. This integer is the sum of the three hall bit states, where $FB1.HALLSTATE = Hall\ U + Hall\ V + Hall\ W$. If the hall is not active, it will return 0. When a hall is active, each hall will contribute the following value to the sum:

- Hall U = 1
- Hall V = 2
- Hall W = 4

Value	Hall U	Hall V	Hall W
0	-	-	-
1	√	-	-
2	-	√	-
3	√	√	-
4	-	-	√
5	√	-	√
6	-	√	√
7	√	√	√

The following sequences indicate the direction of rotation.

Sequence	Direction
1,5,4,6,2,3,1	Positive
1,3,2,6,4,5,1	Negative

Related Topics

Feedback 1 (→ p. 56) | FB1.HALLSTATEU (→ p. 445) | FB1.HALLSTATEV (→ p. 446) |
FB1.HALLSTATEW (→ p. 447)

19.12.8 FB1.HALLSTATEU

General Information	
Type	R/O Parameter
Description	Reads the state of Hall switch U.
Units	N/A
Range	0 and 1
Default Value	1
Data Type	Integer
See Also	FB1.HALLSTATE (→ p. 443)
Start Version	M_01-03-07-000

Description

FB1.HALLSTATEU reads the state of Hall switch U.

Related Topics

Feedback 1 (→ p. 56)

19.12.9 FB1.HALLSTATEV

General Information	
Type	R/O Parameter
Description	Reads the state of Hall switch V.
Units	N/A
Range	0 and 1
Default Value	1
Data Type	Integer
See Also	FB1.HALLSTATE (→ p. 443)
Start Version	M_01-03-07-000

Description

FB1.HALLSTATEV reads the state of Hall switch V.

Related Topics

Feedback 1 (→ p. 56)

19.12.10 FB1.HALLSTATEW

General Information	
Type	R/O Parameter
Description	Reads the state of Hall switch W.
Units	N/A
Range	0 and 1
Default Value	1
Data Type	Integer
See Also	FB1.HALLSTATE (→ p. 443)
Start Version	M_01-03-07-000

Description

FB1.HALLSTATEW reads the state of Hall switch W.

Related Topics

Feedback 1 (→ p. 56)

19.12.11 FB1.IDENTIFIED

General Information	
Type	R/O Parameter
Description	Reads the type of feedback device used by the drive/motor.
Units	N/A
Range	N/A
Default Value	N/A
Data Type	Integer
See Also	FB1.SELECT
Start Version	M_01-00-00-000

Description

This parameter is set according to FB1.SELECT on drive power up if FB1.SELECT is not –1; otherwise the parameter value is read from the drive memory.

Type	Description
0	Unknown
1	No encoder
10	Incremental encoder with A/B Quad, marker pulse and Hall
11	Incremental encoder with A/B Quad, marker pulse and no Hall
12	Halls Only
20	Sine Encoder , with marker pulse and Hall
21	Sine encoder , with marker pulse & No Halls
30	EnDat 2.1 with Sine Cosine
31	EnDat 2.2
32	BiSS with Sine Cosine
33	HIPERFACE
34	BiSS Mode C Renishaw
40	Resolver
41	SFD (Smart Feedback Device)
42	Tamagawa. This feedback type is not available on models with extension type NA (AKD PDMM Models (→ p. 27)).
43	Network Cyclic Feedback
44	FB2 Cyclic Feedback
45	SFD3
46	Hiperface DSL
50	Reserved
63	Simulated Motor

Related Topics

Feedback 1 (→ p. 56)

19.12.12 FB1.INITPSAVED

General Information	
Type	R/O Parameter
Description	Reads position saved at last power down.
Units	Depends on UNIT.PLINEAR (pg 1) or UNIT.PROTARY (pg 1) Rotary: counts, rad, deg, (custom units), 16-bit counts Linear: counts, mm, μ m, (custom units), 16-bit counts
Range	N/A
Default Value	N/A
Data Type	Integer
Start Version	M_01-10-00-000

Description

This parameter reports the position FB1.P (→ p. 461) that was saved at the last power-down. The position can be represented in internal counts or in custom units depending on the value of FB1.PUNIT. In internal units, the format is 32:32. The upper 32 bits represent turns, and the lower 32 bits represent position within a turn.

Related Topics

Initial Position Check | FB1.INITPSTATUS (→ p. 450) | FB1.INITPWINDOW (→ p. 451)

19.12.13 FB1.INITPSTATUS

General Information	
Type	R/O Parameter
Description	Reads result of initial position comparison.
Units	N/A
Range	N/A
Default Value	N/A
Data Type	Integer
Start Version	M_01-10-00-000

Description

This parameter reports the status of the initial position comparison:

Value	Description
0	Initial position check is in progress.
1	Initial position check is disabled.
2	Position difference between power-up and power-down is less than value of FB1.INITPWINDOW at start up.
3	Position difference between power-up and power-down is greater than or equal to value of FB1.INITPWINDOW at start up.
4	Initial position check encountered an error condition.

Related Topics

Initial Position Check | FB1.INITPSAVED (→ p. 449) | FB1.INITPWINDOW (→ p. 451)

19.12.14 FB1.INITPWINDOW

General Information	
Type	R/W Parameter
Description	Reads and writes size of the initial position comparison window.
Units	Depends on FB1.PUNIT (→ p. 470).
Range	N/A
Default Value	N/A
Data Type	Integer
Start Version	M_01-10-00-000

Description

This parameter defines the amount by which the position measured at power-up may differ from the position saved at power-down. If the difference is less than the window size, the position change at power off is considered small, and homing may be avoided. If the difference is greater than or equal to the window size, the position change during power off is large enough to require homing. Changes in the window size take effect after a non-volatile memory save and a power cycle. A window value of 0 disables the initial position check.

Related Topics

Initial Position Check | FB1.INITPSAVED (→ p. 449) | FB1.INITPSTATUS (→ p. 450)

19.12.15 FB1.INITSIGNED

General Information	
Type	NV Parameter
Description	Sets initial feedback value as signed or unsigned.
Units	N/A
Range	0 to 1
Default Value	1
Data Type	Integer
See Also	FB1.ORIGIN
Start Version	M_01-00-00-000

Fieldbus	Index/Subindex	Object Start Version
EtherCAT COE and CANopen	508Fh/0	M_01-00-00-000

Description

This parameter sets whether the initial value of the feedback read from the feedback device will be set as a signed or as an unsigned value.

0 = Unsigned

1 = Signed

The drive internal process for the feedback initialization is as follows:

1. Reads the position feedback.
2. Adds the origin to the feedback.
3. Determines modulo from Step 2 by the actual feedback bits.
4. Sets the position feedback sign according to FB1.INITSIGNED.

Related Topics

Feedback 1 (→ p. 56)

19.12.16 FB1.LASTIDENTIFIED

General Information	
Type	NV Parameter
Description	Stores the feedback type auto-detected during the last feedback initialization. Auto-detection will look for this type first.
Units	N/A
Range	30 (EnDat 2.1), 32 (BiSS with Sine Cosine), 33 (HIPERFACE), 41 (SFD), 45 (SFD3)
Default Value	41 (SFD)
Data Type	Integer
Start Version	M_01-10-01-000

Description

If FB1.SELECT (→ p. 473) is set to -1, AKD PDMM automatically detects the feedback device. When auto-detection is successful, the identified feedback type is stored in FB1.LASTIDENTIFIED. On the next feedback initialization, the auto-detection algorithm will first look for the last identified type, speeding up feedback initialization and shortening drive boot time.

The time to automatically identify the device is shortened when FB1.LASTIDENTIFIED is already set to the correct feedback type.

Note that this parameter must be saved to non-volatile memory with DRV.NVSAVE (→ p. 412) in order to take effect each time the drive powers up.

Related Topics

Feedback 1 (→ p. 56) | FB1.SELECT (→ p. 473) | FB1.IDENTIFIED (→ p. 448)

19.12.17 FB1.MECHPOS

General Information	
Type	R/O Parameter
Description	Reads the mechanical position.
Units	counts
Range	0 to 4,294,967,295 counts
Default Value	N/A
Data Type	Integer
See Also	N/A
Start Version	M_01-00-00-000

Fieldbus	Index/Subindex	Object Start Version
EtherCAT COE and CANopen	35D2h/0	M_01-00-00-000

Description

FB1.MECHPOS reads the mechanical angle which is equal to the lower 32 bits in the 64-bit position feedback word.

Related Topics

Feedback 1 (→ p. 56)

19.12.18 FB1.MEMVER

General Information	
Type	R/O Parameter
Description	Returns the memory feedback version.
Units	N/A
Range	N/A
Default Value	N/A
Data Type	Integer
See Also	N/A
Start Version	M_01-00-00-000

Description

FB1.MEMVER returns the memory feedback version (only applicable for feedbacks with memory).

Related Topics

Feedback 1 (→ p. 56)

19.12.19 FB1.MOTORPHASE

General Information	
Type	NV Parameter
Description	Sets the motor phase of the motor associated with FB1.
Units	Electrical degrees
Range	0 to 359
Default Value	0
Data Type	Integer
Start Version	M_01-11-04-000

Description

This parameter sets the phase offset for commutation of the motor associated with FB1. When multiple motors are driven by a single AKD PDMM, this allows different motor configurations to be saved for each value of IL.FBSOURCE (→ p. 534).

When IL.FBSOURCE is set to 0, the value of FB1.MOTORPHASE will overwrite the value of MOTOR.PHASE (→ p. 596). Additionally, while IL.FBSOURCE = 0, a write to MOTOR.PHASE will also overwrite FB1.MOTORPHASE.

Related Topics

Motor (→ p. 52)

19.12.20 FB1.MOTORPOLES

General Information	
Type	NV Parameter
Description	Sets the number of motor poles associated with FB1.
Units	N/A
Range	0 to 510
Default Value	0
Data Type	Integer
Start Version	M_01-11-04-000

Description

This parameter sets the number of motor poles associated with FB1. When multiple motors are driven by a single AKD PDMM, this allows different motor configurations to be saved for each value of IL.FBSOURCE (→ p. 534).

When IL.FBSOURCE is set to 0, the value of FB1.MOTORPOLES will overwrite the current value of MOTOR.POLES (→ p. 600). Additionally, while IL.FBSOURCE = 0, a write to MOTOR.POLES will also overwrite FB1.MOTORPOLES.

Related Topics

Motor (→ p. 52)

19.12.21 FB1.OFFSET

General Information	
Type	NV-Parameter
Description	Sets position feedback offset.
Units	Rotary: counts, rad, deg, 16-bit counts Linear: counts, mm, μm , 16-bit counts
Range	Rotary: -5,123,372,000,000,005.000 to 5,123,372,000,000,005.000 counts -7495.067 to 7495.067 rad -429,436.096 to 429,436.096 deg -78,176,452.637 to 78,176,452.636 16-bit counts Linear: -5,123,372,000,000,005.000 to 5,123,372,000,000,005.000 counts -1192.878*MOTOR.PITCH (\rightarrow p. 599) to 1192.878*MOTOR.PITCH mm -1192877.952*MOTOR.PITCH to 1192877.952*MOTOR.PITCH μm -78176452.637 to 78176452.636 16-bit counts
Default Value	0
Data Type	Float
Start Version	M_01-00-00-000

Fieldbus	Index/Subindex	Object Start Version
EtherCAT COE and CANopen	3533h/0	M_01-00-00-000

Description

FB1.OFFSET is a value added to the position feedback (PL.FB (\rightarrow p. 625)).

Example

If PL.FB is 10 deg and FB1.OFFSET is set to -10 deg, then the next read of PL.FB will return ~0 deg.

Related Topics

Feedback 1 (\rightarrow p. 56)| PL.FB (\rightarrow p. 625)

19.12.22 FB1.ORIGIN

General Information	
Type	NV Parameter
Description	Adds to the initial feedback position.
Units	Depends on UNIT.PROTARY or UNIT.PLINEAR Rotary: counts, rad, deg, custom units, 16-bit counts Linear: counts, mm, µm, custom units, 16-bit counts
Range	Rotary: 0.000 to 5,123,372,000,000.000 counts 0.000 to 7,495.067 rad 0.000 to 429,436.096 deg 0.000 to 5,964.390 custom units 0.000 to 78,176,452.636 16-bit counts Linear: 0.000 to 5,123,372,000,000.000 counts 0.000 to 1,192.878 mm 0.000 to 1,192,877.952 µm 0.000 to 5,964.390 custom units 0.000 to 78,176,452.636 counts 16 Bit
Default Value	0 counts
Data Type	Float
See Also	FB1.INITSIGNED
Start Version	M_01-00-00-000

Fieldbus	Index/Subindex	Object Start Version
EtherCAT COE and CANopen	3656h/0	M_01-00-00-000

Description

FB1.ORIGIN is a value that is added to the feedback device position.

If the modulo is disabled (PL.MODPEN is set to disabled), then the origin is added to the position feedback.

Initial position value = (<feedback from device> + FB1.ORIGIN)

However, if modulo is enabled (PL.MODPEN is set to enabled) then the modulo is applied to both the feedback device position and the origin value.

The modulo value is defined by PL.MODP1 and PL.MODP2

Initial position value = (<feedback from device> + FB1.ORIGIN) modulo

The drive internal process for the feedback initialization is as follows:

1. Reads the position feedback.
2. Adds the origin to the feedback.
3. Determines modulo from Step 2 by the actual feedback bits.
4. Sets the position feedback sign according to FB1.INITSIGNED (→ p. 452).

Example

This example assumes that the drive is connected to a single turn feedback device with memory.

FB1.ORIGIN is set to 22 degrees and saved into NV memory.

Drive boots and reads from feedback device position 340 degrees. According to the description section above, calculation will be:

With PL.MODPEN disabled:

Initial feed back will be set to 366 degrees.

$$(340 + 22) = 366 \text{ degrees.}$$

With PL.MODPEN enabled:

Initial feedback will be set to 2 degrees.

$$\text{PL.MODP1} = 0$$

$$\text{PL.MODP2} = 360$$

$$(340 + 22) \text{ modulo } 360 = 2 \text{ degrees.}$$

Related Topics

7.2 Feedback 1

19.12.23 FB1.P

General Information	
Type	R/O Parameter
Description	Reads position from the primary feedback.
Units	Depends on FB1.PUNIT (→ p. 470) counts or custom units.
Range	N/A
Default Value	N/A
Data Type	S64
Start Version	M_01-05-08-000

Description

This parameter reads the position of the primary feedback device connected to X10. The position can be read as counts or in custom units. This is the raw position read back from the device. The output format is 32:32, the upper 32 bits represent the multi-turns and the lower 32 bits represent the position of the feedback.

Related Topics

Feedback 1 (→ p. 56) | FB1.PUNIT (→ p. 470) | FB1.PIN | FB1.POUT

19.12.24 FB1.PDIR

General Information	
Type	NV-Parameter
Description	Sets the counting direction for feedback channel 1.
Units	None
Range	0 to 1
Default Value	0
Data Type	U8
See Also	N/A
Start Version	M_01-05-11-000

Description

FB1.PDIR will change the sign and with it the direction of feedback channel 1.

Example

If position feedback = 35,185.932 counts and you set:

--> FB1.PDIR 1

then position feedback = -35,185.932 counts

19.12.25 FB1.PFIND

General Information	
Type	R/W Parameter
Description	A procedure that allows the user to find the commutation angle for encoder feedback, which has no halls.
Units	NA
Range	0, 1
Default Value	0
Data Type	Integer
See Also	FB1.PFINDCMDU (→ p. 464)
Start Version	M_01-00-00-000

Description

A procedure that allows the user to find the commutation angle for encoder feedback (which has no Halls).

Related Topics

Feedback 1 (→ p. 56)

19.12.26 FB1.PFINDCMDU

General Information	
Type	R/W Parameter
Description	Current value used during the phase finding procedure (PFB.PFIND=1)
Units	A
Range	0 to DRV.IPEAK
Default Value	0
Data Type	Float
See Also	PFB.PFIND
Start Version	M_01-00-00-000

Fieldbus	Index/Subindex	Object Start Version
EtherCAT COE and CANopen	5096h/0	M_01-00-00-000

Description

FB1.PFINDCMDU sets the current value used during the phase finding procedure.

Related Topics

Feedback 1 (→ p. 56)

19.12.27 FB1.PIN

General Information	
Type	NV Parameter
Description	Sets gear IN for FB1.P (→ p. 461).
Units	N/A
Range	0 to 4,294,967,295
Default Value	100
Data Type	Integer
Start Version	M_01-05-011-000

Description

Use FB1.PIN with FB1.POUT (→ p. 468) to set the user units for FB1.P (→ p. 461).

Related Topics

Feedback 1 (→ p. 56) | FB1.PUNIT (→ p. 470) | FB1.P (→ p. 461) | FB1.POUT (→ p. 468)

19.12.28 FB1.POFFSET

General Information	
Type	NV-Parameter
Description	Sets the offset for primary feedback.
Units	counts, custom units
Range	-5,123,372,000,000,005.000 to 5,123,372,000,000,005.000 counts or -10,485,760.000 to 10,485,760.000 custom units
Default Value	0
Data Type	S64
See Also	N/A
Start Version	M_01-05-11-000

Fieldbus	Index/Subindex	Object Start Version
EtherCAT COE and CANopen	3490h/0	M_01-00-00-000

Description

FB1.POFFSET is the value added to the primary feedback position (FB1.P (→ p. 461)).

Example

If FB1.P is 10000 counts and FB1.POFFSET is set to -10000 counts, then the next read of FB1.P will return ~0 counts.

19.12.29 FB1.POLES

General Information	
Type	R/W Parameter
Description	Reads the number of feedback poles.
Units	N/A
Range	2 to 510
Default Value	2
Data Type	Integer
See Also	MOTOR.POLES
Start Version	M_01-00-00-000

Fieldbus	Index/Subindex	Object Start Version
EtherCAT COE and CANopen	5097h/0	M_01-00-00-000

Description

FB1.POLES sets the number of individual poles in the feedback device. This variable is used for the commutation function, as well as for velocity feedback scaling, and represents the number of individual poles (not pole pairs). The division value of motor poles (MOTOR.POLES) and feedback poles (FB1.POLES) must be an integer when moving drive to enable, otherwise a fault is issued.

Related Topics

Feedback 1 (→ p. 56)

19.12.30 FB1.POUT

General Information	
Type	NV Parameter
Description	Sets gear IN for FB1.P (→ p. 461).
Units	N/A
Range	0 to 4,294,967,295
Default Value	20
Data Type	Integer
Start Version	M_01-05-011-000

Description

Use FB1.POUT with FB1.PIN (→ p. 465) to set the user units for FB1.P (→ p. 461).

Related Topics

Feedback 1 (→ p. 56) | FB1.PUNIT (→ p. 470) | FB1.P (→ p. 461) | FB1.PIN (→ p. 465)

19.12.31 FB1.PSCALE

General Information	
Type	R/W Parameter
Description	Sets position scaling value for fieldbus transferred position objects.
Units	N/A
Range	0 to 32
Default Value	20
Data Type	Integer
See Also	N/A
Start Version	M_01-00-00-000

Description

Position values transferred over fieldbus are converted from native 64-bit values to a maximum 32-bit position value. This parameter sets the resolution/revolution of position values back to the controller.

FB1.PSCALE determines the counts per revolution of position values delivered by fieldbus. The default value is 20, which yields 2^{20} counts/revolution. This scaling is used for CAN PDOs 6064 (Position Actual Value) and 60F4 (Following Error Actual Value).

Example

The drive always works internally with 64-bit position values. The drive internal 64-bit actual position should contain the following value:

0x0000.0023.1234.ABCD

The lower 32 bits represent the mechanical angle of the feedback. The upper 32 bits represent the number of turns.

FB1.PSCALE = 20

The 32-bit position is: 0x0231234A

FB1.PSCALE = 16

The 32-bit position is: 0x00231234

Related Topics

Feedback 1 (→ p. 56)

19.12.32 FB1.PUNIT

General Information	
Type	NV Parameter
Description	Sets the unit for FB1.P.
Units	N/A
Range	0, 3
Default Value	0
Data Type	U8
See Also	N/A
Start Version	M_01-05-11-000

Description

FB1.PUNIT sets the position unit for FB1.P.

Value	Description
0	Counts (32.32 format)
3	(FB1.PIN/FB1.POUT) per revolution.

Related Topics

FB1.P (→ p. 461)

19.12.33 FB1.RESKTR

General Information	
Type	NV Parameter
Description	Sets the resolver nominal transformation ratio.
Units	N/A
Range	0.001 to 50.000
Default Value	0.5
Data Type	Float
See Also	N/A
Start Version	M_01-00-00-000

Fieldbus	Index/Subindex	Object Start Version
EtherCAT COE and CANopen	5099h/0	M_01-00-00-000

Description

This parameter sets the resolver nominal transformation ratio. It affects the resolver excitation output amplitude.

The value can be obtained from the resolver data sheet.

Related Topics

Feedback 1 (→ p. 56)

19.12.34 FB1.RESREFPHASE

General Information	
Type	NV Parameter
Description	Sets the electrical degrees of phase lag in the resolver.
Units	electrical degrees
Range	-180 to 180°
Default Value	-2°
Data Type	Float
See Also	N/A
Start Version	M_01-00-00-000

Fieldbus	Index/Subindex	Object Start Version
EtherCAT COE and CANopen	509Ah/0	M_01-00-00-000

Description

This parameter sets the electrical degrees of phase lag in the resolver.

See the motor resolver datasheet for the value for this parameter .

Related Topics

Feedback 1 (→ p. 56)

19.12.35 FB1.SELECT

General Information	
Type	NV Parameter
Description	Sets user entered type or identified type (-1).
Units	N/A
Range	-1, 1, 10, 11, 20, 21, 30, 31, 32, 33, 34, 40, 41, 42, 43, 45, 46, 50
Default Value	-1
Data Type	Integer
Start Version	M_01-00-00-000

Fieldbus	Index/Subindex	Object Start Version
EtherCAT COE and CANopen	353Bh/0	M_01-00-00-000

Description

FB1.SELECT sets the feedback type manually (see FB1.IDENTIFIED) or allows the drive to automatically identify the feedback type on power up.

FB1 5V Power Supply Notes:

If FB1.SELECT = -1, the 5V power supply will only turn on during the initialization phase. If the feedback type cannot be automatically detected, the 5V power supply will be turned off, and remain off until a DRV.CLRFAULTS is issued (which will re-start the FB1 initialization), or FB1.SELECT is manually set to a specific feedback type.

When FB1.SELECT is manually set to a specific feedback type, the FB1 5V power supply will remain on, unless a short is detected. This is useful for encoder types that may require calibration.

FB1.SELECT Input Values

Changing these input values will manually set the value of FB1.IDENTIFIED (→ p. 448).

NOTE

If the feedback setting fails, FB1.IDENTIFIED is automatically set to 0 (no feedback identified).

Input Value	Description
-1	The drive automatically identifies the type of feedback as part of the power up process. Setting this value does not modify FB1.IDENTIFIED, unless it is saved in the NV memory for the next power up. If a feedback with memory is connected to the drive, the value of FB1.IDENTIFIED is set automatically to the feedback identified and all parameters read from the feedback are set according to the values read from the feedback. If no feedback is connected or a feedback with no memory is connected, the value of FB1.IDENTIFIED is set to 0 (no feedback identified) and all values normally read from the feedback are read from NV memory (if stored in NV) otherwise they are set to the default values.
0	Unknown. No feedback identified.
1	Manually sets the type to No Encoder. This setting can be used if no feedback device is connected to the X10 connector. This may be the case if FB2 or FB3 is used for position or velocity control.
10	Manually sets the type to Incremental encoder with A/B Quad, marker pulse and Hall.
11	Manually sets the type to Incremental encoder with A/B Quad, marker pulse and no Hall.

Input Value	Description
12	<p>Manually sets the type to Halls Only feedback (added 01-13-08-000).</p> <p>This feedback type only supports operating in Torque mode and Velocity mode.</p> <p>Due to heavy quantization, large current spikes occur at hall transition points, it is advisable to tune the observer to a low frequency (like 10Hz) and set the observer gain appropriately to achieve the best operating results.</p>
20	Manually sets the type to Sine Encoder , with marker pulse and Hall.
21	Manually sets the type to Sine encoder , with marker pulse & No Halls.
30	Manually sets the type to Endat 2.1 with Sine Cosine.
31	Manually sets the type to Endat 2.2.
32	Manually sets the type to BiSS (Analog) with Sine Cosine.
33	<p>Manually sets the type to Hiperface.</p> <p>Note that all Hiperface feedback types are supported by the AKD PDMM. This includes SEL/SEK 37, SEL/SEK 52, SKM/SKS 36, SRS/SRM 50, SRS/SRM 60, SEK 90, SEK160, and SEK 260. The AKD PDMM drive will support any new Hiperface device, since any new device will be released with a label type of 0xFF. Devices with this label type have all of the pertinent information to configure these devices (number of single turn bits, number of multi-turn bits, and number of sine/cosine periods) stored in their memory. The AKD PDMM is able to read this information, and automatically configure the drive for proper operation. Note that the devices SEK 90, SEK 160, and SEK 260 are label type 0xFF.</p>
34	Manually sets the type to BiSS Mode C, Renishaw.
40	Manually sets the type to Resolver.
41	Manually sets the type to SFD (Smart Feedback Device).
42	Manually sets the type to Tamagawa. This feedback type is not available on models with extension type NA (AKD PDMM Models (→ p. 27)).
43	Manually sets the type to use Cyclic Feedback from the Motion Network.
45	<p>Manually sets the type to SFD3. This value is only supported on model numbers AKD PDMM-xxyyzz-NBxx. This value is only supported for firmware version 01-11-00-000 and later.</p> <p>To use 2 wire SFD3 there must be an external feedback connection adapter between the 2 wires and the AKD X10 primary feedback connector. The feedback connection adapter comes standard on Kollmorgen single motor cables.</p>
46	<p>Manually sets the type to Hiperface DSL. This value is only supported on model numbers AKD PDMM-xxyyzz-NBxx. This value is only supported for firmware versions 01-09-00-000 and later.</p> <p>To use 2 wire Hiperface DSL there must be an external feedback connection adapter between the 2 wires and the AKD X10 primary feedback connector. The feedback connection adapter comes standard on Kollmorgen single motor cables.</p>
50	This value is reserved and should not be used.
63	Manually sets the type to a simulated motor. This value is only supported on model numbers AKD PDMM-xxyyzz-NBxx.

Related Topics

7.2 Feedback 1 | FB1.IDENTIFIED (→ p. 448)

19.12.36 FB1.TRACKINGCAL

General Information	
Type	NV Parameter
Description	Controls tracking calibration algorithm.
Units	N/A
Range	0 to 1
Default Value	0
Data Type	Integer
See Also	N/A
Start Version	M_01-00-00-000

Fieldbus	Index/Subindex	Object Start Version
EtherCAT COE and CANopen	509Ch/0	M_01-00-00-000

Description

This parameter turns the tracking calibration algorithm for 1 Vp-p analog sine-cosine feedback on or off. When enabled and the axis is moving, the interface nulls any offset voltage, corrects gain mismatches between the two channels, and corrects the two channels to be exactly 90 Deg apart. This process automatically turns on above 48 kHz sine-cosine input frequency and when going below 47 kHz the offset, gain, and quadrature adjustment values are sampled and held. This process makes the motion smoother while moving with less unintended acoustic noise. However, because the adjustments will slightly change move-to-move, the repeatability of position holds is slightly degraded.

0 = Tracking calibration is off.

1 = Tracking calibration is on.

Related Topics

Feedback 1 (→ p. 56)

19.12.37 u

FB1.USERBYTE0 to FB1.USERBYTE7

General Information	
Type	R/W
Description	Reads and writes data stored in eight 8 bit bytes in an Endat or Hiperface feedback device.
Units	N/A
Range	0 to 255
Default Value	0
Data Type	Integer
Start Version	M_01-05-08-000

Fieldbus	Index/Subindex	Object Start Version
EtherCAT COE and CANopen	34B2h/1	FB1.USERBYTE1
	34B2h/2	FB1.USERBYTE2
	34B2h/3	FB1.USERBYTE3
	34B2h/4	FB1.USERBYTE4
	34B2h/5	FB1.USERBYTE5
	34B2h/6	FB1.USERBYTE6
	34B2h/7	FB1.USERBYTE7
	34B2h/8	FB1.USERBYTE8
		M_01-00-00-000

Description

FB1.USERBYTE, FB1.USERWORD, and FB1.USERDWORD share two 32 bit words in an Endat or Hiperface feedback device. These three parameters offer different ways to store and access the data stored in these two 32 bit words. The table below defines each parameters function. The values are automatically stored non-volatile in the feedback device.

Parameter	Bits	Attributes
FB1.USERBYTE0 to FB1.USERBYTE7	8 bit	signed or unsigned char
FB1.USERWORD0 to FB1.USERWORD3	16 bit	signed or unsigned short
FB1.USERDWORD0 to FB1.USERDWORD1	32 bit	singed or unsigned int

The parameters overlap each other in the following way:

BYTE0	BYTE1	BYTE2	BYTE3	BYTE4	BYTE5	BYTE6	BYT7
WORD0		WORD1		WORD2		WORD3	
DWORD0				DWORD1			

For example, if BYTE1 is modified, WORD0 and DWORD0 are modified as well.

Example

```
-->FB1.USERDWORD1 65536
-->FB1.USERBYTE1
0
-->FB1.USERBYTE2
```

```
1
-->FB1.USERBYTE3
0

-->FB1.USERBYTE3 1 (write to the highest byte of FB1.USERDWORD0)
-->FB1.USERDWORD0
16842752
-->FB1.USERWORD0
0
-->FB1.USERWORD1
257
```

Related Topics

Feedback 1 (→ p. 56) | FB1.USERWORD0 to FB1.USERWORD3 (→ p. 480) | FB1.USERDWORD0 to FB1.USERDWORD1 (→ p. 478)

19.12.38 FB1.USERDWORD0 to FB1.USERDWORD1

General Information	
Type	R/W
Description	Reads and writes data stored in two 32 bit words in an Endat or Hiperface feedback device.
Units	N/A
Range	0 to 4,294,967,295
Default Value	0
Data Type	Integer
Start Version	M_01-05-08-000

Fieldbus	Index/Subindex	Object Start Version
EtherCAT COE and CANopen	34B0h (→ p. 963)/1	FB1.USERDWORD1
	34B0h/2	FB1.USERDWORD2
		M_01-00-00-000

Description

FB1.USERBYTE, FB1.USERWORD, and FB1.USERDWORD share two 32 bit words in an Endat or Hiperface feedback device. These three parameters offer different ways to store and access the data stored in these two 32 bit words. The table below defines each parameters function. The values are automatically stored non-volatile in the feedback device.

Parameter	Bits	Attributes
FB1.USERBYTE0 to FB1.USERBYTE7	8 bit	signed or unsigned char
FB1.USERWORD0 to FB1.USERWORD3	16 bit	signed or unsigned short
FB1.USERDWORD0 to FB1.USERDWORD1	32 bit	singed or unsigned int

The parameters overlap each other in the following way:

BYTE0	BYTE1	BYTE2	BYTE3	BYTE4	BYTE5	BYTE6	BYT7
WORD0		WORD1		WORD2		WORD3	
DWORD0				DWORD1			

For example, if BYTE1 is modified, WORD0 and DWORD0 are modified as well.

Example

```
-->FB1.USERDWORD1 65536
-->FB1.USERBYTE1
0
-->FB1.USERBYTE2
1
-->FB1.USERBYTE3
0

-->FB1.USERBYTE3 1 (write to the highest byte of FB1.USERDWORD0)
-->FB1.USERDWORD0
```

16842752

-->FB1.USERWORD0

0

-->FB1.USERWORD1

257

Related Topics

Feedback 1 (→ p. 56) | u (→ p. 476) | FB1.USERWORD0 to FB1.USERWORD3 (→ p. 480)

19.12.39 FB1.USERWORD0 to FB1.USERWORD3

General Information	
Type	R/W
Description	Reads and writes data stored in four 16 bit words in an Endat or Hiperface feedback device.
Units	N/A
Range	0 to 65,535
Default Value	0
Data Type	Integer
Start Version	M_01-05-08-000

Fieldbus	Index/Subindex	Object Start Version
EtherCAT COE and CANopen	34B1h/1	FB1.USERWORD1
	34B1h/2	FB1.USERWORD2
	34B1h/3	FB1.USERWORD3
	34B1h/4	FB1.USERWORD4
		M_01-00-00-000

Description

FB1.USERBYTE, FB1.USERWORD, and FB1.USERDWORD share two 32 bit words in an Endat or Hiperface feedback device. These three parameters offer different ways to store and access the data stored in these two 32 bit words. The table below defines each parameters function. The values are automatically stored non-volatile in the feedback device.

Parameter	Bits	Attributes
FB1.USERBYTE0 to FB1.USERBYTE7	8 bit	signed or unsigned char
FB1.USERWORD0 to FB1.USERWORD3	16 bit	signed or unsigned short
FB1.USERDWORD0 to FB1.USERDWORD1	32 bit	singed or unsigned int

The parameters overlap each other in the following way:

BYTE0	BYTE1	BYTE2	BYTE3	BYTE4	BYTE5	BYTE6	BYT7
WORD0		WORD1		WORD2		WORD3	
DWORD0				DWORD1			

For example, if BYTE1 is modified, WORD0 and DWORD0 are modified as well.

Example

```
-->FB1.USERDWORD1 65536
-->FB1.USERBYTE1
0
-->FB1.USERBYTE2
1
-->FB1.USERBYTE3
0
```



```
-->FB1.USERBYTE3 1 (write to the highest byte of FB1.USERDWORD0)
-->FB1.USERDWORD0
16842752
-->FB1.USERWORD0
0
-->FB1.USERWORD1
257
```

Related Topics

Feedback 1 ([→ p. 56](#)) | u ([→ p. 476](#)) | FB1.USERDWORD0 to FB1.USERDWORD1 ([→ p. 478](#))

19.13 FB3 Parameters

This section describes the FB3 parameters.

19.13.1 FB3.DIR	483
19.13.2 FB3.ENCRES	484
19.13.3 FB3.MODE	485
19.13.4 FB3.MOTORPHASE	486
19.13.5 FB3.MOTORPOLES	487
19.13.6 FB3.P	488
19.13.7 FB3.PDIR	489
19.13.8 FB3.PIN	490
19.13.9 FB3.POFFSET	491
19.13.10 FB3.POUT	492
19.13.11 FB3.PUNIT	493

19.13.1 FB3.DIR

General Information	
Type	NV Parameter
Description	Sets the counting direction for the position feedback when PL.FBSOURCE = 2.
Units	None
Range	0 to 1
Default Value	0
Data Type	U8
See Also	N/A
Start Version	M_01-11-03-000

Description

FB3.DIR will change the sign and with it the direction of the position feedback (PL.FB (→ p. 625)) when PL.FBSOURCE = 2 (FB3).

19.13.2 FB3.ENCRES

General Information	
Type	NV Parameter
Description	Sets the resolution of the motor encoder for feedback 3.
Units	None
Range	0 to 4,294,967,295
Default Value	0
Data Type	Integer
Start Version	M_01-11-03-000

Description

Feedback 3 is natively scaled to 4,294,967,296 counts per revolution for rotary motors, and 4,294,967,296 per motor pole pitch (MOTOR.PITCH (→ p. 599)) for linear motors. When FB3.ENCRES is non-zero, scaling is applied on top of the native scaling.

Rotary Example:

A second feedback device is placed at the load which has a 1:4 gear ratio (motor does four revolutions per secondary revolution). In this case, FB3.ENCRES should be $4,294,967,296 / 4 = 1,073,741,824$

Linear Example:

Linear encoder resolution can be calculated as the number of encoder counts per one revolution of the motor. For example, if a linear setup has a 10nm scale (100,000 counts/nm), and the ballscrew has a 10mm lead with no gearbox, it will result in 1,000,000 counts for every revolution of the motor shaft. For this example, FB3.ENCRES should be set to 1,000,000.

19.13.3 FB3.MODE

General Information	
Type	NV Parameter
Description	Selects the type of feedback connected to X9.
Units	N/A
Range	0
Default Value	0
Data Type	Integer
See Also	NA
Start Version	M_01-04-15-000

Description

This parameter selects the type of feedback connected to X9. The position is reported as the tertiary feedback position, by FB3.P.

Value	Feedback
0	Endat 2.2 Feedback Device

This parameter is only supported on drives with model numbers similar to AKD PDMM-x-xxxxx-NBxx-xxxx.

19.13.4 FB3.MOTORPHASE

General Information	
Type	NV Parameter
Description	Sets the motor phase of the motor associated with FB3.
Units	Electrical degrees
Range	0 to 359
Default Value	0
Data Type	Integer
Start Version	M_01-11-04-000

Description

This parameter sets the phase offset for commutation of the motor associated with FB3. When multiple motors are driven by a single AKD PDMM, this allows different motor configurations to be saved for each value of IL.FBSOURCE (→ p. 534).

When IL.FBSOURCE is set to 2, the value of FB3.MOTORPHASE will overwrite the value of MOTOR.PHASE (→ p. 596). Additionally, while IL.FBSOURCE = 2, a write to MOTOR.PHASE will also overwrite FB3.MOTORPHASE.

Related Topics

Motor (→ p. 52)

19.13.5 FB3.MOTORPOLES

General Information	
Type	NV Parameter
Description	Sets the number of motor poles associated with FB3.
Units	N/A
Range	0 to 510
Default Value	0
Data Type	Integer
Start Version	M_01-11-04-000

Description

This parameter sets the number of motor poles associated with FB3. When multiple motors are driven by a single AKD PDMM, this allows different motor configurations to be saved for each value of IL.FBSOURCE (→ p. 534).

When IL.FBSOURCE is set to 2, the value of FB3.MOTORPOLES will overwrite the current value of MOTOR.POLES (→ p. 600). Additionally, while IL.FBSOURCE = 2, a write to MOTOR.POLES will also overwrite FB3.MOTORPOLES.

Related Topics

Motor (→ p. 52)

19.13.6 FB3.P

General Information	
Type	R/O Parameter
Description	Reads position from the tertiary feedback.
Units	Depends on FB3.PUNIT (→ p. 493) counts or custom units.
Range	N/A
Default Value	N/A
Data Type	S64
See Also	N/A
Start Version	M_01-04-15-000

Description

This parameter reads the position back from the tertiary feedback device that is connected to X9, when `DRV.EMUEMODE = 11`. The position can be read as 64-bit signed count or in customer units. Values read by this parameter depend on `FB3.Dir` and `FB3.OFFSET`.

This parameter is only supported on drives with model numbers similar to `AKD PDMM-x-xyzz-NBxx-yyzz` and will only work with Endat 2.2 multiturn encoder. The output format is 32:32 the upper 32 bits represents the multiturns and the lower 32 bits for position of the feedback.

Related Topics

`DRV.EMUEMODE` (→ p. 379) | `FB3.PUNIT` (→ p. 493) | `FB3.PIN` | `FB3.POUT` | `FB3.PDIR` (→ p. 489) |

19.13.7 FB3.PDIR

General Information	
Type	NV-Parameter
Description	Sets the counting direction for feedback channel 3.
Units	None
Range	0 to 1
Default Value	0
Data Type	U8
See Also	N/A
Start Version	M_01-05-11-000

Description

FB3.PDIR will change the sign and with it the direction of feedback channel 3 (FB3.P (→ p. 488)).

Example

If FB3.P = 35,185.932 and you set:

→ FB3.PDIR 1

then FB3.P = -35,185.932

19.13.8 FB3.PIN

General Information	
Type	NV Parameter
Description	Sets gear IN for FB3.P (→ p. 488).
Units	N/A
Range	0 to 4,294,967,295
Default Value	100
Data Type	Integer
Start Version	M_01-05-011-000

Description

Use FB3.PIN with FB3.POUT (→ p. 492) to set the user units for FB3.P (→ p. 488).

Related Topics

Feedback 1 (→ p. 56) | FB3.PUNIT (→ p. 493) | FB3.P (→ p. 488) | FB3.POUT (→ p. 492)

19.13.9 FB3.POFFSET

General Information	
Type	NV-Parameter
Description	Sets the offset for tertiary feedback.
Units	counts, custom units
Range	-5,123,372,000,000,005.000 to 5,123,372,000,000,005.000 counts or -10,485,760.000 to 10,485,760.000 custom units
Default Value	0
Data Type	S64
See Also	N/A
Start Version	M_01-05-11-000

Description

FB3.POFFSET is the value added to the primary feedback position (FB3.P (→ p. 488)).

Example

If FB3.P is 10000 counts and FB3.POFFSET is set to -10000 counts, then the next read of FB3.P will return ~0 counts.

19.13.10 FB3.POUT

General Information	
Type	NV Parameter
Description	Sets gear IN for FB3.P (→ p. 488).
Units	N/A
Range	0 to 4,294,967,295
Default Value	20
Data Type	Integer
Start Version	M_01-05-011-000

Description

Use FB3.POUT with FB3.PIN (→ p. 490) to set the user units for FB3.P (→ p. 488).

Related Topics

Feedback 1 (→ p. 56) | FB3.PUNIT (→ p. 493) | FB3.P (→ p. 488) | FB3.PIN (→ p. 490)

19.13.11 FB3.PUNIT

General Information	
Type	NV Parameter
Description	Sets the unit for FB3.P.
Units	N/A
Range	0, 3
Default Value	0
Data Type	U8
See Also	N/A
Start Version	M_01-05-11-000

Description

FB3.UNIT sets the position unit for FB3.P.

Value	Description
0	Counts (32.32 format)
3	(FB3.PIN/FB3.POUT) per revolution.

Related Topics

FB3.P (→ p. 488)

19.14 FBUS Parameters

This section describes the FBUS parameters.

19.14.1 FBUS.PARAM1 TO FBUS.PARAM10	495
19.14.2 FBUS.PLLSTATE	497
19.14.3 FBUS.PLLTHRESH	498
19.14.4 FBUS.PROTECTION	499
19.14.5 FBUS.REMOTE	501
19.14.6 FBUS.SAMPLEPERIOD	502
19.14.7 FBUS.STATE	503
19.14.8 FBUS.SYNCACT	504
19.14.9 FBUS.SYNCDIST	505
19.14.10 FBUS.SYNCWND	506
19.14.11 FBUS.TYPE	507

19.14.1 FBUS.PARAM1 TO FBUS.PARAM10

General Information	
Type	NV Parameter
Description	Set fieldbus specific meanings.
Units	N/A
Range	See table below.
Default Value	See table below.
Data Type	Unsigned 32
See Also	CANbus Communication Manual, EtherCAT Communication Manual
Start Version	M_01-00-00-000

Parameter	EtherCAT COE Range	CANopen Range
FBUS.PARAM01	N/A	125; 250; 500; 1000
FBUS.PARAM02	0 to 1	0 to 1
FBUS.PARAM03	1,001 to 65,535	N/A
FBUS.PARAM04	0 to 1	0 to 1
FBUS.PARAM05	0 to 511	0 to 511

Parameter	EtherCAT COE Default Value	CANopen Default Value
FBUS.PARAM01	N/A	125
FBUS.PARAM02	1	0
FBUS.PARAM03	0	N/A
FBUS.PARAM04	1	0
FBUS.PARAM05	0	0

Fieldbus	Index/Subindex				Object Start Version
EtherCAT COE and CANopen	36E5h/0	FBUS.PARAM01	36EAh/0	FBUS.PARAM06	M_01-00-00-000
	36E6h/0	FBUS.PARAM02	36Eb/0	FBUS.PARAM07	
	36E7h/0	FBUS.PARAM03	36ECh/0	FBUS.PARAM08	
	36E8h/0	FBUS.PARAM04	36EDh/0	FBUS.PARAM09	
	36E9h/0	FBUS.PARAM05	36EEh/0	FBUS.PARAM10	

Description

FBUS.PARAM01 sets the baud rate for the CANbus. Supported baud rates are 125, 250, 500 and 1000 kBaud.

FBUS.PARAM02 switches the phase locked loop (PLL) for synchronized use: 0 = OFF, 1 = ON.
FBUS.PARAM02 only works when FBUS.TYPE = 3 (CANopen).

FBUS.PARAM03 sets the configured station alias for EtherCAT.

FBUS.PARAM04 switches the surveillance of SYNC-signals: 0 = OFF, 1 = ON

FBUS.PARAM05 is used to configure some special behaviors of the DS402.

FBUS.PARAM06 - FBUS.PARAM10 are reserved.

FBUS.PARAM04 Additional Notes

FBUS.PARAM04 enables (1) or disables(0) the synchronization supervision of the CAN or EtherCAT field-bus.

Default values:

- CAN: disabled (0)
- EtherCAT: enabled (1)

The synchronization supervision is active when:

- FBUS.PARAM04 = 1
- The first CANopen Sync message or first EtherCAT frame was received.

When more than three CANopen sync messages or seven EtherCAT frames have not been received, and the drive is enabled, fault F125 (→ p. 175), "Synchronization lost", occurs.

FBUS.PARAM05 Additional Notes

Bit 0 configures the behavior of DS402 state machine in case of fault resets.

- **Bit 0 = 1:** Faults can only be reset using DS402 control word bit 7.
- **Bit 0 = 0:** The reset can also be done via telnet or digital input and the DS402 state machine reflects this condition.
- **Bit 1 = 1:** The state of the hardware enable does not change the state machine state Operation Enable.
- **Bit 1 = 0:** If the state Operation Enable or Switched on is active it falls back to the state switched On Disabled, if the Hardware enable goes to 0.
- **Bit 2 = 1:** Workbench/Telnet can software enable the drive when CANopen/EtherCAT are operational.
- **Bit 2 = 0:** Workbench/Telnet can switch the DS402-state machine to the state "Switched On" (enable the power stage), if the former state was "Switched on Disabled." This requires the hardware enable to be set to 1.
- **Bit 3 = 1:** DS402-state machine is not influenced, if the software-enable is taken away via Telnet.
- **Bit 3 = 0:** DS402-state machine is influenced, if the software-enable is taken away via Telnet.
- **Bit 4 = 1:** Position scaling for DS402-parameters is done dependent on DS402-scaling parameters via objects 6091 / 6092. Velocity scaling via 204c.
- **Bit 4 = 0:** Position scaling for DS402-parameters is done dependent on UNIT.PIN.
- **Bit 5 = 1:** EtherCAT: The setting of the rotary switches define the station alias address, if FBUS. PARAM03 is on 0 else FBUS.PARAM03 is used to store the station alias address.
- **Bit 5 = 0:** EtherCAT: The setting of the rotary switches define the station alias address. If the setting is 0, FBUS.PARAM03 can be used.
- **Bit 6 = 1:** Bit 0 of the parameter MT.CNTL (object 35D9 sub 0) can be accessed.
- **Bit 6 = 0:** Bit 0 of the parameter MT.CNTL (object 35D9 sub 0) is exclusively used for DS402 control word.
- **Bit 7:** Reserved
- **Bit 8 = 1:** DS402-state switched on, power stage disabled.
- **Bit 8 = 0:** DS402-state switched on, power stage enabled.
- **Bit 11 = 1** No emergency messages over CANopen are triggered when a drive warning occurs.

19.14.2 FBUS.PLLSTATE

General Information	
Type	R/O Parameter
Description	Returns the status of the PLL
Units	N/A
Range	N/A
Default Value	N/A
Data Type	N/A
See Also	FBUS.PARAM1 TO FBUS.PARAM10 (→ p. 495), Fieldbus documentation
Start Version	M_01-02-00-000

Description

FBUS.PLLSTATE returns the status of the phase locked loop (PLL). The PLL states are as follows:

PLL State	Description
PLL not activated	This state is set using FBUS.PARAM02. Not each fieldbus or operation mode needs synchronization.
PLL activated, but unlocked	The PLL is activated but has not yet been locked successfully. This state is related to the fieldbus master, as well as to the fieldbus mode of operation.
PLL activated and locked	PLL is fully operational and locked

19.14.3 FBUS.PLLTHRESH

General Information	
Type	NV Parameter
Description	Sets number of successful synchronized cycles needed to lock the PLL.
Units	N/A
Range	0 to 10,000
Default Value	0
Data Type	Integer, U32
See Also	Appendix B: Fieldbus Manuals
Start Version	M_01-00-00-000

Fieldbus	Index/Subindex	Object Start Version
EtherCAT COE and CANopen	50B1h/0	M_01-00-00-000

Description

This parameter sets number of successful synchronized cycles needed to lock the PLL.

19.14.4 FBUS.PROTECTION

General Information	
Type	R/W Parameter
Description	Controls which parameters are blocked from being accessed through telnet while a fieldbus is operational.
Units	N/A
Range	0 to 1
Default Value	0
Data Type	Integer
Start Version	M_01-08-00-000

Fieldbus Information

Fieldbus	Index/Subindex	Object Start Version
EtherCAT COE and CANopen	3498h/0	M_01-08-00-000

Description

When an AKD PDMM is a slave node on a fieldbus (for example an AKD PDMM is connected to an EtherCAT master) and EWW¹ is simultaneously connected to an AKD PDMM via a service channel, then you have several options on how you would like the AKD PDMM to respond to commands from each of the channels.

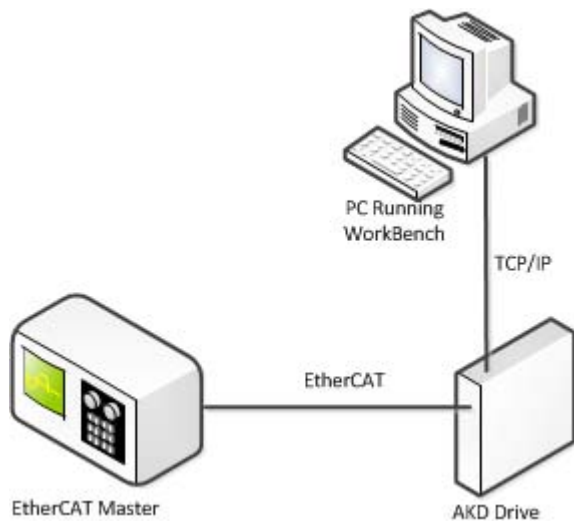

When the fieldbus is operational the AKD PDMM uses the FBUS.PROTECTION parameter to allow the user to select how commands from EWW, or any other device sending commands to the drive through a service channel, should be handled. EWW can use either of two service channels: Telnet or ASCII SDO. Both service channels are affected identically by FBUS.PROTECTION.

The following table shows the available options. If the fieldbus is not connected or not started, then parameters executed through a service channel will not be blocked.

¹Embedded Workbench Views

Value	Description
0	Motion and Tuning Commands Allowed - Commands that would interfere with motion are allowed. Gain and IO configuration changes are allowed.
1	Block Motion but Allow Tuning Commands - Commands that would interfere with motion are blocked. Gain and I/O configuration changes are allowed.

DRV.HELP will include the [Blocked] attribute to indicate whether a parameter is being blocked. For example, if FBUS.PROTECTION is 0 and the network is operational, the following help will be shown.

```
-->DRV.HELP DRV.EN
Help for: DRV.EN [ActionCommand] [Blocked]
-->
```

If you attempt to execute a blocked parameter the following error would display.

```
-->DRV.EN
Error: [0008] Command blocked.
```

All write or command functions of a parameter will be blocked by FBUS.PROTECTION. FBUS.PROTECTION will not block the read function of any parameter.

When the fieldbus is operational, FBUS.PROTECTION is always blocked, but can be edited through the fieldbus. This ensures that the protection level can only be modified by the fieldbus when it is in control.

If a parameter is blocked through telnet, it will be accessible through the fieldbus. For example, SDO's in the case of CANopen or EtherCAT.

Parameters Affected by FBUS.PROTECTION

This table shows how the blocked attribute affects the following parameters in each state of FBUS.PROTECTION. This table is true only if FBUS.STATE = 5 (operational).

FBUS.PROTECTION	0 - Block Nothing	1 - Block Motion Commands
DRV.EN DRV.DIS		[Blocked]
FBUS.PROTECTION		[Blocked]
DRV.OPMODE DRV.CMDSOURCE		[Blocked]
DRV.STOP DRV.CLRFAULTS		[Blocked]

Related Topics

FBUS.STATE

19.14.5 FBUS.REMOTE

General Information	
Type	R/W Parameter
Description	Changes or shows the control of the drive (fieldbus master/telnet)
Units	N/A
Range	0 to 1
Default Value	0
Data Type	U8
See Also	Fieldbus ManualsPL.FBSOURCE (→ p. 626)
Start Version	M_01-05-06-000

Description

DS402 (CAN/EtherCAT):

With this parameter the bit 9 (remote) of the DS402-status word can be set directly via Telnet to show the DS402-master-system that the control is removed. The master has to react on that.

19.14.6 FBUS.SAMPLEPERIOD

General Information	
Type	NV Parameter
Description	Sets fieldbus sample period.
Units	Whole multiples of MTS 250 μ s
Range	4 to 128 and value must be a power of 4
Default Value	32 = 2 ms
Data Type	U8
See Also	Appendix B: Fieldbus Manuals
Start Version	M_01-00-00-000

Fieldbus	Index/Subindex	Object Start Version
EtherCAT COE and CANopen	60C2h/0	M_01-00-00-000

Description

This parameter sets the fieldbus cycle time. It is normally written in the startup phase of the field busses via the object 60C2 subindex 1 (interpolation time units) and 2 (interpolation time index), where the index stands for a power of 10 seconds (for instance, -3 stands for milliseconds) and the units are the counts of these units. Kollmorgen recommends the following standard cycle rates, 250 μ s (4), 500 μ s (8), 1 ms (16), 2 ms (32), 4 ms (64).

19.14.7 FBUS.STATE

General Information	
Type	R/O
Description	Reads the state of the fieldbus.
Units	N/A
Range	Depends on fieldbus. See table below.
Default Value	Depends on fieldbus. See table below.
Data Type	Integer
Start Version	M_01-08-00-000

Description

FBUS.STATE returns the current state of the fieldbus. The value returned is dependent upon the fieldbus being used.

Value	CANopen over CAN	CANopen over EtherCAT
-1	Not connected	Not connected
0	Init.	-
1	N/A	Init.
2	N/A	Pre-operational
3	-	Boot
4	Stopped	Safe-operational
5	Operational	-
8	-	Operational
127	Pre-operational	-

19.14.8 FBUS.SYNCACT

General Information	
Type	R/O Parameter
Description	Reads actual distance from the desired sync distance.
Units	ns
Range	0 to 250,000 ns
Default Value	0 ns
Data Type	Integer, U 32
See Also	Appendix B: Fieldbus Manuals
Start Version	M_01-00-00-000

Fieldbus	Index/Subindex	Object Start Version
EtherCAT COE and CANopen	3496h/2	M_01-00-00-000

Description

This parameter reads actual distance from the desired sync distance.

19.14.9 FBUS.SYNCDIST

General Information	
Type	NV Parameter
Description	Sets time target for synchronization.
Units	ns
Range	0 to 250,0000 ns
Default Value	100,000 ns
Data Type	Integer, U32
See Also	Appendix B: Fieldbus Manuals
Start Version	M_01-00-00-000

Fieldbus	Index/Subindex	Object Start Version
EtherCAT COE and CANopen	3496h/1	M_01-00-00-000

Description

This parameter sets time target for synchronization.

19.14.10 FBUS.SYNCWND

General Information	
Type	NV Parameter
Description	Sets symmetrically arranged window around the desired sync distance.
Units	ns
Range	0 to 1,000,000 ns
Default Value	50,000 ns
Data Type	Integer, U2
See Also	Appendix B: Fieldbus Manuals
Start Version	M_01-00-00-000

Fieldbus	Index/Subindex	Object Start Version
EtherCAT COE and CANopen	3496h/3	M_01-00-00-000

Description

This parameter sets symmetrically arranged window around the desired sync distance.

19.14.11 FBUS.TYPE

General Information	
Type	R/O Parameter
Description	Shows the active fieldbus type.
Units	N/A
Range	0 to 6
Default Value	0
Data Type	U8
See Also	Fieldbus Manuals
Start Version	M_01-00-00-000

Description

FBUS.TYPE shows the active fieldbus type.

0 = Analog

1 = SynqNet

2 = EtherCAT

3 = CANopen

4 = EthernetIP

5 = Profinet

6 = sercos[®] III

19.15 GUI Parameters

GUI parameters are used within EWV¹ for data reporting and data storage.

19.15.1 GUI.DISPLAY	509
19.15.2 GUI.DISPLAYS	510
19.15.3 GUI.PARAM01	511
19.15.4 GUI.PARAM02	512
19.15.5 GUI.PARAM03	513
19.15.6 GUI.PARAM04	514
19.15.7 GUI.PARAM05	515
19.15.8 GUI.PARAM06	516
19.15.9 GUI.PARAM07	517
19.15.10 GUI.PARAM08	518
19.15.11 GUI.PARAM09	519
19.15.12 GUI.PARAM10	520

¹Embedded Workbench Views

19.15.1 GUI.DISPLAY

General Information	
Type	R/O Parameter
Description	Reads drive display data.
Units	N/A
Range	N/A
Default Value	N/A
Data Type	Display
See Also	N/A
Start Version	M_01-00-00-000

Description

This parameter reports to the GUI what the drive currently is displaying. For all GUI commands, the data is compressed and formatted for the GUI, not for the user.

19.15.2 GUI.DISPLAYS

General Information	
Type	R/O Parameter
Description	Reads drive display data.
Units	N/A
Range	N/A
Default Value	N/A
Data Type	Display
Start Version	M_01-09-06-000

Description

This parameter reports to the GUI what the drive currently is displaying. For all GUI commands, the data is compressed and formatted for the GUI, not for the user.

19.15.3 GUI.PARAM01

General Information	
Type	NV Parameter
Description	Used by the GUI to store data.
Units	N/A
Range	2,147,483,648 to 2,147,483,647
Default Value	0
Data Type	Integer
See Also	N/A
Start Version	M_01-00-00-000

Description

The GUI uses this parameter to store data. Only the GUI can modify this data (not the user).

19.15.4 GUI.PARAM02

General Information	
Type	NV Parameter
Description	Used by the GUI to store data.
Units	N/A
Range	2,147,483,648 to 2,147,483,647
Default Value	0
Data Type	Integer
See Also	N/A
Start Version	M_01-00-00-000

Description

The GUI uses this parameter to store data. Only the GUI can modify this data (not the user).

19.15.5 GUI.PARAM03

General Information	
Type	NV Parameter
Description	Used by the GUI to store data.
Units	N/A
Range	2,147,483,648 to 2,147,483,647
Default Value	0
Data Type	Integer
See Also	N/A
Start Version	M_01-00-00-000

Description

The GUI uses this parameter to store data. Only the GUI can modify this data (not the user).

19.15.6 GUI.PARAM04

General Information	
Type	NV Parameter
Description	Used by the GUI to store data.
Units	N/A
Range	2,147,483,648 to 2,147,483,647
Default Value	0
Data Type	Integer
See Also	N/A
Start Version	M_01-00-00-000

Description

The GUI uses this parameter to store data. Only the GUI can modify this data (not the user).

19.15.7 GUI.PARAM05

General Information	
Type	NV Parameter
Description	Used by the GUI to store data.
Units	N/A
Range	2,147,483,648 to 2,147,483,647
Default Value	0
Data Type	Integer
See Also	N/A
Start Version	M_01-00-00-000

Description

The GUI uses this parameter to store data. Only the GUI can modify this data (not the user).

19.15.8 GUI.PARAM06

General Information	
Type	NV Parameter
Description	Used by the GUI to store data.
Units	N/A
Range	2,147,483,648 to 2,147,483,647
Default Value	0
Data Type	Integer
See Also	N/A
Start Version	M_01-00-00-000

Description

The GUI uses this parameter to store data. Only the GUI can modify this data (not the user).

19.15.9 GUI.PARAM07

General Information	
Type	NV Parameter
Description	Used by the GUI to store data.
Units	N/A
Range	2,147,483,648 to 2,147,483,647
Default Value	0
Data Type	Integer
See Also	N/A
Start Version	M_01-00-00-000

Description

The GUI uses this parameter to store data. Only the GUI can modify this data (not the user).

19.15.10 GUI.PARAM08

General Information	
Type	NV Parameter
Description	Used by the GUI to store data.
Units	N/A
Range	2,147,483,648 to 2,147,483,647
Default Value	0
Data Type	Integer
See Also	N/A
Start Version	M_01-00-00-000

Description

The GUI uses this parameter to store data. Only the GUI can modify this data (not the user).

19.15.11 GUI.PARAM09

General Information	
Type	NV Parameter
Description	Used by the GUI to store data.
Units	N/A
Range	2,147,483,648 to 2,147,483,647
Default Value	0
Data Type	Integer
See Also	N/A
Start Version	M_01-00-00-000

Description

The GUI uses this parameter to store data. Only the GUI can modify this data (not the user).

19.15.12 GUI.PARAM10

General Information	
Type	NV Parameter
Description	Used by the GUI to store data.
Units	N/A
Range	2,147,483,648 to 2,147,483,647
Default Value	0
Data Type	Integer
See Also	N/A
Start Version	M_01-00-00-000

Description

The GUI uses this parameter to store data. Only the GUI can modify this data (not the user).

19.16 HWLS Parameters

This section describes the HWLS parameters.

19.16.1 HWLS.NEGSTATE	522
19.16.2 HWLS.POSSTATE	523

19.16.1 HWLS.NEGSTATE

General Information	
Type	R/O Parameter
Description	Reads the status of the negative hardware limit switch.
Units	0 to 1
Range	N/A
Default Value	Integer
Data Type	HWLS.POSSTATE (→ p. 523)
See Also	N/A
Start Version	M_01-00-00-000

Description

HWLS.NEGSTATE reads the status of the negative HW limit switch as follows:

0 = Low

1 = High

Related Topics

19.16.2 HWLS.POSSTATE

General Information	
Type	R/O Parameter
Description	Reads the status of the positive hardware limit switch.
Units	N/A
Range	0 to 1
Default Value	N/A
Data Type	Integer
See Also	HWLS.NEGSTATE (→ p. 522)
Start Version	M_01-00-00-000

Description

HWLS.POSSTATE reads the status of the positive hardware limit switch as follows:

0 = Low

1 = High

Related Topics

19.17 IL Parameters

This section describes the IL parameters.

19.17.1 IL.BUSFF	526
19.17.2 IL.CMD	527
19.17.3 IL.CMDACC	528
19.17.4 IL.CMDU	529
19.17.5 IL.DCMD	530
19.17.6 IL.DFB	531
19.17.7 IL.DIFOLD	532
19.17.8 IL.FB	533
19.17.9 IL.FBSOURCE	534
19.17.10 IL.FF	535
19.17.11 IL.FOLDFTHRESH	536
19.17.12 IL.FOLDFTHRESHU	537
19.17.13 IL.FOLDWTHRESH	538
19.17.14 IL.FRCTION	539
19.17.15 IL.IFOLD	540
19.17.16 IL.IUFB	541
19.17.17 IL.IVFB	542
19.17.18 IL.KACFF	543
19.17.19 IL.KBUSFF	544
19.17.20 IL.KP	545
19.17.21 IL.KPDRATIO	546
19.17.22 IL.KPLOOKUPINDEX	547
19.17.23 IL.KPLOOKUPVALUE	548
19.17.24 IL.KPLOOKUPVALUES	549
19.17.25 IL.KVFF	550
19.17.26 IL.LIMITN	551
19.17.27 IL.LIMITP	552
19.17.28 IL.MFOLDD	553
19.17.29 IL.MFOLDR	554
19.17.30 IL.MFOLDT	555
19.17.31 IL.MI2T	556
19.17.32 IL.MI2TWTHRESH	557

19.17.33 IL.MIFOLD	558
19.17.34 IL.MIMODE	559
19.17.35 IL.OFFSET	560
19.17.36 IL.VCMD	561
19.17.37 IL.VUFB	562
19.17.38 IL.VVFB	563

19.17.1 IL.BUSFF

General Information	
Type	R/O Parameter
Description	Displays the current feedforward value injected by the field-bus.
Units	Arms
Range	N/A
Default Value	N/A
Data Type	Float
See Also	IL.KBUSFF (→ p. 544)
Start Version	M_01-00-00-000

Description

This parameter displays the current feedforward value injected by the fieldbus.

Related Topics

- 1 Current Loop

19.17.2 IL.CMD

General Information	
Type	R/O Parameter
Description	Reads the value of the q-component current command.
Units	Arms
Range	± Drive peak current (DRV.IPEAK)
Default Value	N/A
Data Type	Float
See Also	DRV.IPEAK (→ p. 401)
Start Version	M_01-00-00-000

Description

IL.CMD displays the q-component current command value of the current loop after any limitation (such as a parameter setting or I^2t calculation).

IL.CMD is limited also by motor peak current, IL.LIMITN (→ p. 551) and IL.LIMITP (→ p. 552).

Related Topics

- 1 Current Loop

19.17.3 IL.CMDACC

General Information	
Type	R/O Parameter
Description	Returns the commanded acceleration from the trajectory generator.
Units	Depends on UNIT.ACCLINEAR or UNIT.ACCROTARY.
Range	+/- 64bit
Default Value	0
Data Type	Float
Start Version	M_01-08-03-000

Fieldbus	Index/Subindex	Is 64 bit?	Attributes	Signed?
Modbus	1760	Yes	64-bit	Yes

Description

Use IL.CMDACC to monitor the commanded acceleration for a given motion. This keyword is useful for tuning acceleration feedforward (IL.KACCFF).

Related Topics

IL.KACCFF (→ p. 543) | Tuning Guide (→ p. 135)

19.17.4 IL.CMDU

General Information	
Type	R/W Parameter
Description	Sets the user current command.
Units	Arms
Range	Minimum range value = maximum of IL.LIMITN and -MOTOR.IPEAK Maximum range value = minimum of IL.LIMITP and MOTOR.IPEAK
Default Value	0 Arms
Data Type	Float
See Also	DRV.IPEAK (→ p. 401), DRV.OPMODE (→ p. 414), DRV.CMDSOURCE (→ p. 362)
Start Version	M_01-00-00-000

Description

This parameter sets the user current command value.

The current command value, which is provided to the current loop (IL.CMD), can be limited further using a parameter setting or I^2t calculation. IL.CMDU is limited also by motor peak current, IL.LIMITN (→ p. 551) and IL.LIMITP (→ p. 552).

For IPM motors (MOTOR.TYPE = 6), IL.CMDU is decomposed into d-component and q-component current values, as both are used for closed loop current control. The d-component value is used to set IL.DCMD (→ p. 530), and the q-component value is used to set IL.CMD (→ p. 527).

Related Topics

- 1 Current Loop

19.17.5 IL.DCMD

General Information	
Type	R/O Parameter
Description	Reads the value of the d-component current controller inside the FPGA.
Units	Arms
Range	± Drive peak current (DRV.IPEAK)
Default Value	N/A
Data Type	Float
See Also	DRV.IPEAK (→ p. 401)
Start Version	M_01-00-00-000

Description

This command displays the d-component current command value of the current loop. This parameter is commonly used with IPM motors (MOTOR.TYPE = 6), where the d-component current is controlled for closed loop current regulation.

19.17.6 IL.DFB

General Information	
Type	R/O Parameter
Description	Reads the actual value of the d-component current.
Units	Arms
Range	± Drive peak current (DRV.IPEAK)
Default Value	N/A
Data Type	Float
See Also	N/A
Start Version	M_01-11-00-000

Description

This parameter displays the measured, de-rotated d-component current value of the motor. This parameter is commonly used with IPM motors (MOTOR.TYPE = 6), where the d-component current is controlled for closed loop current regulation.

19.17.7 IL.DIFOLD

General Information	
Type	R/O Parameter
Description	Reads the drive foldback current limit.
Units	Arms
Range	0 to 2,147,483.647 Arms
Default Value	N/A
Data Type	Float
See Also	Foldback
Start Version	M_01-00-00-000

Fieldbus	Index/Subindex	Object Start Version
EtherCAT COE and CANopen	3559h/0	M_01-00-00-000

Description

IL.DIFOLD is the output of the drive foldback algorithm. It is an artificial current, which can be higher or lower than the drive peak current (DRV.IPEAK). When IL.DIFOLD is lower than the existing current limit (such as IL.LIMITP (→ p. 552)), it becomes the active current limit.

IL.DIFOLD decreases when the actual current is higher than drive continuous current and increases (up to a certain level) when the actual current is lower than drive continuous current.

Related Topics

- 1 Current Loop

19.17.8 IL.FB

General Information	
Type	R/O Parameter
Description	Reads the actual value of the q-component current.
Units	Arms
Range	± Drive peak current (DRV.IPEAK)
Default Value	N/A
Data Type	Float
See Also	N/A
Start Version	M_01-00-00-000

Fieldbus	Index/Subindex	Object Start Version
EtherCAT COE and CANopen	3558h/0	M_01-00-00-000

Description

This parameter reads the measured, de-rotated actual current value of the motor.

Note: Internally the resolution of the current scale is 20130 increments. For an AKD PDMM with a peak current of 9 amps, the current resolution applied is $9/20130 = .447$ mA. For a 48 amp peak current drive, the resolution is $48/20130 = 2.38$ mA. The current scaling is hard coded and cannot be changed by decreasing the peak current settings in the drive.

Related Topics

- 1 Current Loop

19.17.9 IL.FBSOURCE

General Information	
Type	R/W
Description	Sets the feedback source for the current loop. Only applies when MOTOR.TYPE = 4.
Units	N/A
Range	0 to 2
Default Value	0
Data Type	Integer
Start Version	M_01-08-00-000

Fieldbus	Index/Subindex	Object Start Version
EtherCAT COE and CANopen	5361h/0	M_01-08-00-000

Description

This parameter selects the feedback source that current loop uses for commutation angle calculation. It applies only when MOTOR.TYPE = 4.

0 = Primary feedback

1 = Secondary feedback

2 = Tertiary feedback

When IL.FBSOURCE is changed, MOTOR.POLES and MOTOR.PHASE are updated.

IL.FBSOURCE	MOTOR.PHASE is set to:	MOTOR.POLES is set to:
0	FB1.MOTORPHASE	FB1.MOTORPOLES
1	FB2.MOTORPHASE	FB2.MOTORPOLES
2	FB3.MOTORPHASE	FB3.MOTORPOLES

For induction motor closed loop control the commutation angle is set as shown in the following figure.

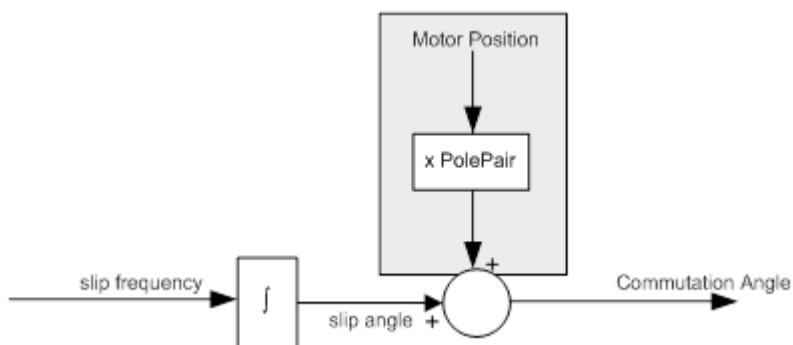

Related Topics

MOTOR.TYPE (→ p. 611)

FB1.MOTORPOLES (→ p. 457) | FB2.MOTORPOLES (→ p. 1) | FB3.MOTORPOLES (→ p. 487)

FB1.MOTORPHASE (→ p. 456) | FB2.MOTORPHASE (→ p. 1) | FB3.MOTORPHASE (→ p. 486)

19.17.10 IL.FF

General Information	
Type	R/O Parameter
Description	Reads the current loop overall feedforward value
Units	Arms
Range	N/A
Default Value	N/A
Data Type	Float
See Also	IL.KBUSFF (→ p. 544), IL.KVFF (→ p. 550), IL.OFFSET (→ p. 560), IL.FRCTION (→ p. 539), IL.KACCCFF (→ p. 543)
Start Version	M_01-00-00-000

Description

IL.FF reads the present current loop overall feed-forward value. It is the sum of the following feed-forward paths:

- Acceleration feed-forward (determined by IL.KACCCFF (→ p. 543))
- Velocity feed-forward (determined by VL.KVFF (→ p. 723))
- Friction feed-forward (determined by IL.FRCTION (→ p. 539))
- Gravity offset feed-forward (determined by IL.OFFSET (→ p. 560))

IL.FF is calculated using the following variables' values at the time it is called:

$IL.FF = IL.KACCCFF * \text{Acceleration Command} + VL.KVFF * \text{Velocity Command} + IL.FRCTION$ (if motion is currently commanded) + IL.OFFSET (always)

Related Topics

- 1 Current Loop

19.17.11 IL.FOLDFTHRESH

General Information	
Type	R/O Parameter
Description	Reads the foldback fault level.
Units	Arms
Range	0 to 500 Arms
Default Value	Drive peak current (DRV.IPEAK)
Data Type	Float
See Also	Foldback
Start Version	M_01-00-00-000

Fieldbus	Index/Subindex	Object Start Version
EtherCAT COE and CANopen	3420h/0	M_01-00-00-000

Description

IL.FOLDFTHRESH is the fault level of the current foldback algorithm. If IL.IFOLD (→ p. 540) drops below the value for IL.FOLDFTHRESH, then a fault is generated and the drive is disabled.

To avoid reaching the current foldback fault level, set IL.FOLDFTHRESHU well below the continuous current value for both the drive and the motor or set the IL.FOLDFTHRESHU value to zero.

Related Topics

- 1 Current Loop

19.17.12 IL.FOLDFTHRESHU

General Information	
Type	NV Parameter
Description	Sets the user value for the foldback fault level.
Units	Arms
Range	0 to 500 Arms
Default Value	Drive peak current (DRV.IPEAK)
Data Type	Float
See Also	IL.FOLDFTHRESH (→ p. 536), Foldback (→ p. 61)
Start Version	M_01-00-00-000

Fieldbus	Index/Subindex	Object Start Version
EtherCAT COE and CANopen	3421h/0	M_01-00-00-000

Description

IL.FOLDFTHRESHU is the fault level of the current foldback algorithm. The value of IL.FOLDFTHRESH is the minimum of DRV.IPEAK (→ p. 401), MOTOR.IPEAK (→ p. 589), and IL.FOLDFTHRESHU.

Related Topics

- 1 Current Loop

19.17.13 IL.FOLDWTHRESH

General Information	
Type	NV Parameter
Description	Sets the foldback warning level.
Units	Arms
Range	0 to 500 Arms
Default Value	0 A
Data Type	Float
See Also	Foldback
Start Version	M_01-00-00-000

Fieldbus	Index/Subindex	Object Start Version
EtherCAT COE and CANopen	355Ah/0	M_01-00-00-000

Description

IL.FOLDWTHRESH is the warning level of the current foldback algorithm. When IL.IFOLD (→ p. 540) drops **below** IL.FOLDWTHRESH a warning is generated.

To ensure that the current foldback warning level is never reached, IL.FOLDWTHRESH should be set well below the continuous current value for both the drive and the motor. You can also set the IL.FOLDFTHRESH (→ p. 536) value to zero.

Related Topics

- 1 Current Loop

19.17.14 IL.FRICTION

General Information	
Type	R/W Parameter
Description	Sets friction compensation value.
Units	A
Range	0 to the minimum of user positive current limit (IL.LIMITP) and motor peak current (MOTOR.IPEAK).IL.LIMITP (→ p. 552)
Default Value	0
Data Type	Float
See Also	IL.FF
Start Version	M_01-00-00-000

Fieldbus	Index/Subindex	Object Start Version
EtherCAT COE and CANopen	3422h/0	M_01-00-00-000

Description

Position command derivative sign is multiplied by this value to be injected to the current command.

NOTE

IL.FRICTION is active in Position and Velocity modes (DRV.OPMODE = 1, 2), but not active in Torque mode (DRV.OPMODE = 0).

Related Topics

- 1 Current Loop

19.17.15 IL.IFOLD

General Information	
Type	R/O Parameter
Description	Reads the overall foldback current limit.
Units	A
Range	0 to 2,147,483.647 A
Default Value	N/A
Data Type	Float
See Also	Foldback
Start Version	M_01-00-00-000

Fieldbus	Index/Subindex	Object Start Version
EtherCAT COE and CANopen	3425h/0	M_01-00-00-000

Description

Two current foldback algorithms run in parallel in the drive: the drive foldback algorithm and the motor foldback algorithm. Each algorithm uses different sets of parameters.

Each algorithm has its own foldback current limit, IL.DIFOLD and IL.MIFOLD. The overall foldback current limit is the minimum of the two at any given moment.

$$IL.IFOLD = \min (IL.DIFOLD, IL.MIFOLD).$$

IL.DIFOLD is an artificial current, which can be higher or lower than the drive or motor peak current. When IL.IFOLD becomes lower than the existing current limit (such as IL.LIMITP (→ p. 552)), it becomes the active current limit.

Related Topics

- 1 Current Loop

19.17.16 IL.IUFB

General Information	
Type	R/O Parameter
Description	Reads the sigma-delta measured current in the u-winding of the motor.
Units	A
Range	± Drive peak current (DRV.IPEAK)
Default Value	N/A
Data Type	Float
See Also	N/A
Start Version	M_01-00-00-000

Description

This parameter displays the measured current in the u-winding of the motor.

Related Topics

- 1 Current Loop

19.17.17 IL.IVFB

General Information	
Type	R/O Parameter
Description	Sets the sigma-delta measured current in the u-winding of the motor.
Units	A
Range	± Drive peak current (DRV.IPEAK)
Default Value	0 A
Data Type	Float
See Also	N/A
Start Version	M_01-00-00-000

Description

IL.IVFB is an offset value that is added to the measured current in the u-winding of the motor. This value is used for compensating for an error in the current measurement. The drive measures 256 times the current in the u-winding when powering-up the drive. Afterwards, the drive calculates the average value of the measured current and uses this value for the offset value.

Related Topics

- 1 Current Loop

19.17.18 IL.KACFF

General Information	
Type	R/W Parameter
Description	Sets current loop acceleration feedforward gain value
Units	mArms/(rad/s ²)
Range	0 to 39113.288 mArms/(rad/s ²)
Default Value	0 mArms/(rad/s ²)
Data Type	Float
See Also	IL.FF (→ p. 535)
Start Version	M_01-00-00-000

Fieldbus	Index/Subindex	Object Start Version
EtherCAT COE and CANopen	3426h/0	M_01-00-00-000

Description

This value sets the gain for the acceleration feedforward (a scaled second derivative of the position command is added to the current command value).

This parameter is valid only in the position mode (DRV.OPMODE = 2).

Related Topics

- 1 Current Loop

19.17.19 IL.KBUSFF

General Information	
Type	NV Parameter
Description	Current loops fieldbus injected feed-forward gain
Units	NA
Range	0 to 2
Default Value	0
Data Type	Float
See Also	IL.FF (→ p. 535), IL.BUSFF (→ p. 526)
Start Version	M_01-00-00-000

Fieldbus	Index/Subindex	Object Start Version
EtherCAT COE and CANopen	50E2h/0	M_01-00-00-000

Description

This parameter scales the feedforward term added by the fieldbus to the current command. The nominal feed-forward value can be multiplied by this gain value.

This parameter is only used in the position mode (DRV.OPMODE = 2).

Related Topics

- 1 Current Loop

19.17.20 IL.KP

General Information	
Type	NV Parameter
Description	Sets the proportional gain of the q-component of the PI regulator.
Units	V/A
Range	0 to 2,000 V/A
Default Value	Read from the motor or, if no memory, 50.009 V/A
Data Type	Float
See Also	N/A
Start Version	M_01-00-00-000

Fieldbus	Index/Subindex	Object Start Version
EtherCAT COE and CANopen	3598h/0	M_01-00-00-000

Description

IL.KP is used to modify the proportional gain of the PI-loop that controls the q-component of the current.

Related Topics

- 1 Current Loop

19.17.21 IL.KPDRATIO

General Information	
Type	NV Parameter
Description	Sets the proportional gain of the d-component current PI-regulator as a percentage of IL.KP
Units	N/A
Range	0 to 100
Default Value	1
Data Type	Float
See Also	IL.KP (→ p. 545)
Start Version	M_01-00-00-000

Fieldbus	Index/Subindex	Object Start Version
EtherCAT COE and CANopen	3596h/0	M_01-00-00-000

Description

This parameter modifies the proportional gain of the PI-loop, which controls the d-component of the current.

Related Topics

- 1 Current Loop

19.17.22 IL.KPLOOKUPINDEX

General Information	
Type	R/W Parameter
Description	Sets the index into the Current Loop Gain Scheduling Table.
Units	N/A
Range	0 to 255
Default Value	0
Data Type	Integer
See Also	IL.KPLOOKUPVALUE (→ p. 548)IL.KPLOOKUPVALUES (→ p. 549)IL.KP (→ p. 545)
Start Version	M_01-04-00-000

Fieldbus	Index/Subindex	Object Start Version
EtherCAT COE and CANopen	5265h/0	M_01-04-00-000

Description

This parameter sets the index into the Current Loop Gain Scheduling Table. The table is 256 records long, spanning 0 A to 1.62 * DRV.IPEAK.

To determine the level of current that corresponds to a table index, use the following equation:

$$IL.CMD = (\text{Table Index} / 157) * DRV.IPEAK$$

Related Topics

Current Loop

19.17.23 IL.KPLOOKUPVALUE

General Information	
Type	R/W if motor memory not supported. R/O if motor memory supported.
Description	Sets the value of the current loop gain scheduling index.
Units	%
Range	0 to 100.000%
Default Value	0
Data Type	Float
See Also	IL.KPLOOKUPINDEX (→ p. 547), IL.KPLOOKUPVALUES (→ p. 549), IL.KP (→ p. 545)
Start Version	M_01-04-00-000

Fieldbus	Index/Subindex	Object Start Version
EtherCAT COE and CANopen	5266h/0	M_01-04-00-000

Description

This parameter sets the value at the current index into the Current Loop Gain Scheduling Table. The table is 256 records long, spanning 0 A to $1.62 * \text{DRV.IPEAK}$. The value can range from 0% to 100% and determines what percentage of IL.KP will be applied to the current loop.

If the feedback device supports motor memory ($\text{FB1.MEMVER} \geq 0.03$ and $\text{MOTOR.AUTOSSET} = 1$) this parameter is read only. Each index value is automatically calculated and set. This calculation depends on the value of MOTOR.LISAT (→ p. 593).

If the feedback device does not support motor memory, this parameter is read/write. Each index value must be entered manually. Use the following equation to determine what level of current corresponds to a table index:

$$\text{IL.CMD} = (\text{Table Index}/157) * \text{DRV.IPEAK}$$

Example

Assume:

$\text{DRV.IPEAK} = 9 \text{ A}$

$\text{IL.KPLOOKUPINDEX} = 100$

$\text{IL.KPLOOKUPVALUE} = 50$

$\text{IL.KP} = 240$

When $\text{IL.CMD} = 100/157 * 9 = 5.73 \text{ A}$, IL.KP will not be 240, but will be $50\% * 240 = 120$.

Related Topics

Current Loop

19.17.24 IL.KPLOOKUPVALUES

General Information	
Type	R/W Parameter
Description	Gets the Current Loop Gain Scheduling Table.
Units	N/A
Range	N/A
Default Value	N/A
Data Type	Table
See Also	IL.KPLOOKUPINDEX (→ p. 547), IL.KPLOOKUPVALUE (→ p. 548), IL.KP (→ p. 545)
Start Version	M_01-04-00-000

Description

Retrieves the Current Loop Gain Scheduling Table in a comma delimited table.

This table is 256 records long, and the table will return values in the following format:

```
-->IL.KPLOOKUPVALUES
```

```
Index Value
```

```
0, 100.000
```

```
1, 100.000
```

```
2, 100.000
```

```
3, 100.000
```

```
4, 100.000
```

```
5, 100.000
```

```
6, 100.000
```

```
7, 100.000
```

```
8, 100.000
```

```
9, 100.000
```

```
10, 100.000
```

Related Topics

Current Loop

19.17.25 IL.KVFF

General Information	
Type	R/W
Description	Current loop velocity feed-forward gain.
Units	N/A
Range	0 to 2
Default Value	0
Data Type	Float
See Also	IL.FF (→ p. 535)
Start Version	M_01-00-00-000

Description

This parameter sets the gain for the velocity loop feedforward. The nominal feedforward value can be multiplied by this gain value.

This parameter is only used in position mode (DRV.OPMODE (→ p. 414) = 2).

Related Topics

- 1 Current Loop

19.17.26 IL.LIMITN

General Information	
Type	NV Parameter
Description	Sets the negative user (application-specific) current limit.
Units	A
Range	Negative drive peak current (DRV.IPEAK) to 0 A
Default Value	Negative drive peak current (DRV.IPEAK)
Data Type	Float
See Also	IL.LIMITP (→ p. 552)
Start Version	M_01-00-00-000

Fieldbus	Index/Subindex	Object Start Version
EtherCAT COE and CANopen	356Fh/0	M_01-00-00-000

Description

This parameter sets the negative user limit clamp value of the torque-producing q-component current command (IL.CMD (→ p. 527)). The current command is additionally limited by the motor peak current setting (MOTOR.IPEAK (→ p. 589)) and by the present value of the foldback I^{2t} peak motor current protection.

NOTE

This current limit is overwritten by MT.FIXEDSTOPCURRENT while a fixed stop motion task is running in a negative direction. Once the motion task is complete, the limit is restored to the previous IL.LIMITN value.

Related Topics

- 1 Current Loop

19.17.27 IL.LIMITP

General Information	
Type	NV Parameter
Description	Sets the positive user (application-specific) current limit.
Units	A
Range	0 A to drive peak current (DRV.IPEAK)
Default Value	Drive peak current (DRV.IPEAK)
Data Type	Float
See Also	IL.LIMITN (→ p. 551)
Start Version	M_01-00-00-000

Fieldbus	Index/Subindex	Object Start Version
EtherCAT COE and CANopen	356Eh/0	M_01-00-00-000

Description

This parameter sets the positive user limit clamp value of the torque-producing q-component current command (IL.CMD (→ p. 527)). The current command is additionally limited by the motor peak current setting (MOTOR.IPEAK (→ p. 589)) and by the present value of the foldback I^{2t} peak motor current protection.

NOTE

This current limit is overwritten by MT.FIXEDSTOPCURRENT while a fixed stop motion task is running in a position direction. Once the motion task is complete, the limit is restored to the previous IL.LIMITP value.

Related Topics

- 1 Current Loop

19.17.28 IL.MFOLDD

General Information	
Type	R/O Parameter
Description	Sets the motor foldback maximum time at motor peak current.
Units	s
Range	0.1 to 2400 s
Default Value	10 s
Data Type	Float
See Also	Foldback
Start Version	M_01-00-00-000

Description

IL.MFOLDD sets the maximum time allowed for the motor to remain at peak current before starting to fold towards the motor continuous current. When at motor peak current, IL.MFOLDD is the amount of time before the foldback algorithm starts to reduce the current.

Related Topics

- 1 Current Loop

19.17.29 IL.MFOLDR

General Information	
Type	R/O Parameter
Description	Sets the motor foldback recovery time.
Units	s
Range	0.1 to 65,535 s
Default Value	Calculated from other foldback parameters.
Data Type	Float
See Also	Foldback
Start Version	M_01-00-00-000

Description

IL.MFOLDR sets the recovery time for the motor foldback algorithm. If 0 current is applied for at least the recovery time duration, it is possible to apply motor peak current for the duration of IL.MFOLDD time.

The IL.MFOLDR value is automatically calculated from other foldback parameters.

Related Topics

- 1 Current Loop

19.17.30 IL.MFOLDT

General Information	
Type	R/O Parameter
Description	Sets the motor foldback time constant of the exponential current drop (foldback).
Units	s
Range	0.1 to 2,400 s
Default Value	10 s
Data Type	Float
See Also	Foldback
Start Version	M_01-00-00-000

Description

IL.MFOLDT sets the time constant of the exponential drop (foldback) of the current towards motor continuous current.

Related Topics

- 1 Current Loop

19.17.31 IL.MI2T

General Information	
Type	R/O parameter
Description	Motor I2t load.
Units	%
Range	0 to 100%
Default Value	N/A
Data Type	Float
See Also	IL.MIMODE, IL.MI2TWITHRESH (→ p. 557)
Start Version	M_01-04-01-000

Fieldbus	Index/Subindex	Object Start Version
EtherCAT COE and CANopen	3427h/3	M_01-00-00-000

Description

This parameter returns the motor I2t load in percent. The supplied current will be limited by IL.MIFOLD to MOTOR.ICONT case that the load reaches a value of 100%. The current limit IL.MIFOLD will be restored to MOTOR.IPEAK in case that the load falls under 95%.

19.17.32 IL.MI2TWTRESH

General Information	
Type	NV Parameter
Description	Motor I2t load warning threshold.
Units	%
Range	0 to 100%
Default Value	N/A
Data Type	Integer
See Also	IL.MIMODE, IL.MI2T (→ p. 556)
Start Version	M_01-04-01-000

Fieldbus	Index/Subindex	Object Start Version
EtherCAT COE and CANopen	3427h/2	M_01-00-00-000

Description

This parameter defines a warning threshold for the IL.MI2T value. A warning n309 will be generated as soon as the IL.MI2T exceeds the IL.MI2TWTRESH value. The warning n309 will be cleared as soon as IL.MI2T falls below the threshold.

Related Topics

Foldback (→ p. 61)

19.17.33 IL.MIFOLD

General Information	
Type	R/O Parameter
Description	Sets the motor foldback current limit.
Units	A
Range	0 to 2147483.647 A
Default Value	N/A
Data Type	Float
See Also	Foldback
Start Version	M_01-00-00-000

Fieldbus	Index/Subindex	Object Start Version
EtherCAT COE and CANopen	35A4h/0	M_01-00-00-000

Description

IL.MIFOLD sets the output of the motor foldback algorithm. It is an artificial current, which can be higher or lower than the motor peak current. When IL.MIFOLD becomes lower than the existing current limit (IL.LIMITP (→ p. 552)) it becomes the active current limit.

IL.MIFOLD decreases when the actual current is higher than motor continuous current and increases (up to a certain level) when the actual current is lower than the motor continuous current.

Related Topics

- 1 Current Loop

19.17.34 IL.MIMODE

General Information	
Type	NV parameter
Description	Motor protection mode.
Units	N/A
Range	0 to 1
Default Value	0
Data Type	Integer
See Also	IL.MI2T (→ p. 556), IL.MI2TWTHRESH (→ p. 557)
Start Version	M_01-04-01-000

Fieldbus	Index/Subindex	Object Start Version
EtherCAT COE and CANopen	3427h/1	M_01-00-00-000

Description

This parameter determines the method of the motor protection.

0 – The motor foldback mechanism is responsible for protecting the motor from overload.

1 – The motor I2t mechanism is responsible for protecting the motor from overload.

Related Topics

Foldback (→ p. 61)

19.17.35 IL.OFFSET

General Information	
Type	RW Parameter
Description	A constant current command added to compensate for gravity.
Units	A
Range	[IL.LIMITN (→ p. 551) to IL.LIMITP (→ p. 552)
Default Value	0 A
Data Type	Float
See Also	IL.FF
Start Version	M_01-00-00-000

Fieldbus	Index/Subindex	Object Start Version
EtherCAT COE and CANopen	3423h/0	M_01-00-00-000

Description

This value is added to the overall current loop feedforward value.

Related Topics

- 1 Current Loop

19.17.36 IL.VCMD

General Information	
Type	R/O Parameter
Description	Reads the output of the q-component PI regulator.
Units	Vrms
Range	0 Vrms to bus voltage
Default Value	N/A
Data Type	Integer
Start Version	M_01-00-00-000

Description

Reads the output of the current loop that controls the q-component of the current.

Related Topics

- 1 Current Loop

19.17.37 IL.VUFB

General Information	
Type	R/O Parameter
Description	Reads the measured voltage on the u-winding of the motor.
Units	V
Range	-1200*VBusScale to +1200*VBusScale
Default Value	N/A
Data Type	Integer
See Also	IL.VVFB (→ p. 563)
Start Version	M_01-00-00-000

Description

Reads the measured voltage on the u-winding of the motor.

Related Topics

- 1 Current Loop

19.17.38 IL.VVFB

General Information	
Type	R/O Parameter
Description	Reads the measured voltage on the v-winding of the motor.
Units	V
Range	-1200*VBusScale to +1200*VBusScale
Default Value	N/A
Data Type	Integer
See Also	IL.VUFB (→ p. 562)
Start Version	M_01-00-00-000

Description

The range for this parameter depends on whether the drive model is an MV/240 VAC or an HV/480 VAC.

The VBusScale parameter sets the drive model:

MV/240 VAC: VBusScale = 1

HV/480 VAC: VBusScale = 2

VBusScale is used for multiple parameter ranges that are model dependent, such as IL.KP.

Related Topics

- 1 Current Loop

19.18 IP Parameters

This section describes the IP parameters.

19.18.1 IP.ADDRESS	565
19.18.2 IP.GATEWAY	566
19.18.3 IP.MODE	567
19.18.4 IP.RESET	568
19.18.5 IP.SUBNET	569

19.18.1 IP.ADDRESS

General Information	
Type	NV Parameter
Description	Gets/Sets the IP address of the drive.
Units	N/A
Range	0.0.0.0 to 255.255.255.255
Default Value	0.0.0.0
Data Type	IP Address
See Also	
Start Version	M_01-04-05-000

Description

This Parameter sets the IP address of the drive. If this parameter has not been set by the user, it will return 0.0.0.0.

By default, DHCP is active, and the drive will acquire an IP Address on its own. When the drive is in DHCP mode, IP.ADDRESS will return 0.0.0.0.

Notes:

- Even when the drive is in DHCP, the actual IP Address will not be returned using this command. The value the user has stored will be returned.
- IP.ADDRESS will only be used by the drive when IP.MODE = 1

If manually setting the IP.ADDRESS, the IP.SUBNET (→ p. 569) and IP.GATEWAY (→ p. 566) must be set up. After the IP.RESET (→ p. 568) command is issued, the new IP settings will be active only if IP.MODE (→ p. 567) has been set to 1.

Recovering communications with a drive on an un-reachable IP address

Sometimes a drive may be configured for an IP Address, and the drive needs to be taken off-line, and bench tested, or otherwise used outside of its saved IP Settings. If IP.MODE has been set to 1 (using software defined static IP) the drive will boot up on an IP Address that may be unreachable with the host computer's settings.

If the IP address prevents communication the IP settings can be reset to default by the following procedure:

- Set both rotary switches to 0
- Hold down button B1 (top-side of drive) for 5 seconds.

The display will flash 0.0.0.0 and then attempt to discover an address by DHCP. Without removing logic power from the drive, use Workbench to connect to the drive, reconfigure the IP address settings as desired, and store the values to non-volatile memory.

Related Topics

IP.GATEWAY (→ p. 566) | IP.RESET (→ p. 568) | IP.SUBNET (→ p. 569) | IP.MODE (→ p. 567)

19.18.2 IP.GATEWAY

General Information	
Type	NV Parameter
Description	Gets/Sets the gateway IP of the drive.
Units	N/A
Range	0.0.0.0 to 255.255.255.255
Default Value	0.0.0.0
Data Type	IP Address
See Also	Communicating with the Drive
Start Version	M_01-04-05-000

Description

This Parameter sets the Gateway IP of the drive. This parameter determines what IP the drive can communicate with outside of its current subnet.

By default, DHCP is active, and the drive will acquire an IP Address on its own. When the drive is in DHCP mode, IP.GATEWAY will return 0.0.0.0.

Notes:

- When the drive is in DHCP, the actual IP GATEWAY will not be returned using this command. The value the user has stored will be returned.
- IP.GATEWAY will only be used by the drive when IP.MODE = 1

If manually setting the IP.ADDRESS (→ p. 565), the IP.SUBNET (→ p. 569) and IP.GATEWAY must be set up. After the IP.RESET (→ p. 568) command is issued, the new IP settings will be active only if IP.MODE (→ p. 567) has been set to 1.

Recovering communications with a drive on an un-reachable IP address

Sometimes a drive may be configured for an IP Address, and the drive needs to be taken off-line, and bench tested, or otherwise used outside of its saved IP Settings. If IP.MODE has been set to 1 (using software defined static IP) the drive will boot up on an IP Address that may be unreachable with the host computer's settings.

If the IP address prevents communication the IP settings can be reset to default by the following procedure:

- Set both rotary switches to 0
- Hold down button B1 (top-side of drive) for 5 seconds.

The display will flash 0.0.0.0 and then attempt to discover an address by DHCP. Without removing logic power from the drive, use Workbench to connect to the drive, reconfigure the IP address settings as desired, and store the values to non-volatile memory.

Related Topics

IP.ADDRESS (→ p. 565) | IP.RESET (→ p. 568) | IP.SUBNET (→ p. 569) | IP.MODE (→ p. 567)

19.18.3 IP.MODE

General Information	
Type	NV Parameter
Description	Sets method of acquiring IP Address.
Units	N/A
Range	0 to 2
Default Value	0
Data Type	Integer
See Also	N/A
Start Version	M_01-04-013-000

Fieldbus	Index/Subindex	Object Start Version
EtherCAT COE and CANopen	525Eh/0	M_01-04-13-000

Description

This command determines which method of acquiring an IP Address the drive will take.

NOTE

Mode 0 and Mode 1 contain multiple methods of acquiring an IP Address. In these modes each method will be implemented in the order they are listed below until an IP Address is acquired

The drive will attempt to acquire a new IP Address as soon as the IP.RESET (→ p. 568) command is issued.

IP Mode	Mode of Acquiring IP Address
0	Rotary Switches, DHCP, Auto IP
1	IP.ADDRESS, IP.SUBNET, IP.GATEWAY
2	DHCP, Auto IP

Recovering communications with a drive on an un-reachable IP address

Sometimes a drive may be configured for an IP Address, and the drive needs to be taken off-line, and bench tested, or otherwise used outside of its saved IP Settings. If IP.MODE has been set to 1 (using software defined static IP), the drive will boot up on an IP Address that may be unreachable with the host computer's settings.

If the IP address prevents communication the IP settings can be reset to default by the following procedure:

- Set both rotary switches to 0
- Hold down button B1 (top-side of drive) for 5 seconds.

The display will flash 0.0.0.0 and then attempt to discover an address by DHCP. Without removing logic power from the drive, use Workbench to connect to the drive, reconfigure the IP address settings as desired, and store the values to non-volatile memory.

Related Topics

IP.ADDRESS (→ p. 565)

IP.GATEWAY (→ p. 566)

IP.RESET (→ p. 568)

IP.SUBNET (→ p. 569)

19.18.4 IP.RESET

General Information	
Type	Command
Description	Implements new IP settings.
Units	N/A
Range	N/A
Default Value	N/A
Data Type	N/A
See Also	Communicating with the Drive
Start Version	M_01-04-05-000

*For Profinet, write a value of 0 into the PNU to execute a command.

Description

When this command is issued a new IP will be acquired using IP.MODE (→ p. 567) to select what method is used.

Notes:

- When issuing this command, it is likely the connection to the drive will be severed, and a new connection will need to be made.
- IP.RESET will return an error if issued while the drive is enabled. IP.RESET is allowed when drive is disabled, or in dynamic braking mode.
- Ensure all values of IP.ADDRESS (→ p. 565), IP.SUBNET (→ p. 569), and IP.GATEWAY (→ p. 566) are configured if using IP.MODE 1

Recovering communications with a drive on an un-reachable IP address

Sometimes a drive may be configured for an IP Address, and the drive needs to be taken off-line, and bench tested, or otherwise used outside of its saved IP Settings. If IP.MODE has been set to 1 (using software defined static IP), the drive will boot up on an IP Address that may be unreachable with the host computer's settings.

If the IP address prevents communication the IP settings can be reset to default by the following procedure:

- Set both rotary switches to 0
- Hold down button B1 (top-side of drive) for 5 seconds.

The display will flash 0.0.0.0 and then attempt to discover an address by DHCP. Without removing logic power from the drive, use Workbench to connect to the drive, reconfigure the IP address settings as desired, and store the values to non-volatile memory.

Related Topics

IP.ADDRESS (→ p. 565) | IP.GATEWAY (→ p. 566) | IP.SUBNET (→ p. 569) | IP.MODE

19.18.5 IP.SUBNET

General Information	
Type	NV Parameter
Description	Gets/Sets the IP subnet mask of the drive.
Units	N/A
Range	0.0.0.0 to 255.255.255.255
Default Value	0.0.0.0
Data Type	IP Address
See Also	
Start Version	M_01-04-05-000

Description

This parameter sets the IP subnet mask of the drive. This parameter determines what IP addresses the drive will be allowed to communicate with.

By default, DHCP is active, and the drive will acquire an IP address on its own. When the drive is in DHCP mode, IP.SUBNET will return 0.0.0.0.

NOTE

The default value of the EtherNet/IP model is 255.255.254.000.

Notes:

- When the drive is in DHCP, the actual IP subnet mask will not be returned using this command. The value the user has stored will be returned.
- IP.SUBNET will only be used by the drive when IP.MODE = 1

If manually setting the IP.ADDRESS (→ p. 565), the IP.SUBNET and IP.GATEWAY (→ p. 566) must be set up. After the IP.RESET (→ p. 568) command is issued, the new IP settings will be active only if IP.MODE (→ p. 567) has been set to 1.

Recovering communications with a drive on an un-reachable IP address

Sometimes a drive may be configured for an IP Address, and the drive needs to be taken off-line, and bench tested, or otherwise used outside of its saved IP Settings. If IP.MODE has been set to 1 (using software defined static IP) the drive will boot up on an IP Address that may be unreachable with the host computer's settings.

If the IP address prevents communication the IP settings can be reset to default by the following procedure:

- Set both rotary switches to 0
- Hold down button B1 (top-side of drive) for 5 seconds.

The display will flash 0.0.0.0 and then attempt to discover an address by DHCP. Without removing logic power from the drive, use Workbench to connect to the drive, reconfigure the IP address settings as desired, and store the values to non-volatile memory.

Related Topics

IP.ADDRESS (→ p. 565) | IP.GATEWAY (→ p. 566) | IP.RESET (→ p. 568) | IP.MODE (→ p. 567)

19.19 LOAD Parameters

This section describes the LOAD parameters.

19.19.1 LOAD.INERTIA	571
-----------------------------------	------------

19.19.1 LOAD.INERTIA

General Information	
Type	NV Parameter
Description	Sets the load inertia.
Units	kgcm ² for rotary motors kg for linear motors
Range	1 to 1,000,000 kgcm ² or kg
Default Value	0 kgcm ² or kg
Data Type	Float
See Also	N/A
Start Version	M_01-03-06-000

Fieldbus	Index/Subindex	Object Start Version
EtherCAT COE and CANopen	525Fh/0	M_01-03-06-000

Description

LOAD.INERTIA sets the load inertia.

Related Topics

Motor (→ p. 52)

19.20 MOTOR Parameters

This section describes the MOTOR parameters.

19.20.1 MOTOR.AUTOSET	574
19.20.2 MOTOR.BRAKE	576
19.20.3 MOTOR.BRAKEIMM	577
19.20.4 MOTOR.BRAKERLS	578
19.20.5 MOTOR.BRAKESTATE	579
19.20.6 MOTOR.CTF0	580
19.20.7 MOTOR.FIELDWEAKENING	581
19.20.8 MOTOR.ICONT	582
19.20.9 MOTOR.IDDATAVALID	583
19.20.10 MOTOR.IDMAX	584
19.20.11 MOTOR.IMID	585
19.20.12 MOTOR.IMTR	586
19.20.13 MOTOR.INERTIA	588
19.20.14 MOTOR.IPEAK	589
19.20.15 MOTOR.KE	590
19.20.16 MOTOR.KT	591
19.20.17 MOTOR.LDLL	592
19.20.18 MOTOR.LISAT	593
19.20.19 MOTOR.LQLL	594
19.20.20 MOTOR.NAME	595
19.20.21 MOTOR.PHASE	596
19.20.22 MOTOR.PHSADV1	597
19.20.23 MOTOR.PHSADV2	598
19.20.24 MOTOR.PITCH	599
19.20.25 MOTOR.POLES	600
19.20.26 MOTOR.R	601
19.20.27 MOTOR.RTYPE	602
19.20.28 MOTOR.SUPPORTEDPARAMS	603
19.20.29 MOTOR.TBRAKEAPP	604
19.20.30 MOTOR.TBRAKERLS	605
19.20.31 MOTOR.TBRAKETO	606
19.20.32 MOTOR.TEMP	607

19.20.33 MOTOR.TEMPC	608
19.20.34 MOTOR.TEMPFAULT	609
19.20.35 MOTOR.TEMPWARN	610
19.20.36 MOTOR.TYPE	611
19.20.37 MOTOR.VMAX	613
19.20.38 MOTOR.VOLTMAX	614
19.20.39 MOTOR.VOLTMIN	615
19.20.40 MOTOR.VOLTRATED	616
19.20.41 MOTOR.VRATED	617

19.20.1 MOTOR.AUTOSSET

General Information	
Type	NV Parameter
Description	Determines which drive parameters are calculated automatically.
Units	N/A
Range	0 to 1
Default Value	0
Data Type	Boolean
See Also	N/A
Start Version	M_01-00-00-000

Fieldbus	Index/Subindex	Object Start Version
EtherCAT COE and CANopen	3451h/0	M_01-00-00-000

Description

This parameter determines whether or not certain drive parameters (see lists below) are calculated automatically. When MOTOR.AUTOSSET = 1 these parameters are automatically calculated from the motor ID data (read from memory-supporting feedback devices). Parameters loaded from motor memory are then read-only and cannot be modified as long as MOTOR.AUTOSSET = 1. If MOTOR.AUTOSSET = 0, parameters are not loaded from motor memory and must be configured by the user. Parameters which are not loaded from motor memory are always read-write.

Three conditions determine which parameters are calculated automatically by MOTOR.AUTOSSET = 1. See the lists below to determine which parameters will automatically be configured from the motor ID data.

The following parameters may be configured automatically when MOTOR.AUTOSSET = 1:

- MOTOR.BRAKE (→ p. 576)
- MOTOR.CTF0 (→ p. 580)
- MOTOR.ICONT (→ p. 582)
- MOTOR.INERTIA (→ p. 588)
- MOTOR.IPEAK (→ p. 589)
- MOTOR.KE (→ p. 590)
- MOTOR.KT (→ p. 591)
- MOTOR.LQLL (→ p. 594)
- MOTOR.NAME (→ p. 595)
- MOTOR.POLES (→ p. 600)
- MOTOR.R (→ p. 601)

If the motor's FB1.MEMVER > 0.01, AKD PDMM will also configure:

- MOTOR.PHASE (→ p. 596)
- MOTOR.TBRAKEAPP (→ p. 604)
- MOTOR.PHASE (→ p. 596)
- MOTOR.VRATED (→ p. 617)
- MOTOR.VOLTRATED (→ p. 616)

For firmware versions 01-09-00-000 and later, AKD PDMM will also configure:

- MOTOR.RTYPE (→ p. 602)
- MOTOR.TEMPFAULT (→ p. 609)

Related Topics

7.1 Motor

19.20.2 MOTOR.BRAKE

General Information	
Type	NV Parameter
Description	Sets the presence or absence of a motor brake.
Units	N/A
Range	0 to 1
Default Value	0
Data Type	Boolean
See Also	N/A
Start Version	M_01-00-00-000

Fieldbus	Index/Subindex	Object Start Version
EtherCAT COE and CANopen	3587h/0	M_01-00-00-000

Description

The MOTOR.BRAKE parameter notifies the firmware whether a brake exists or not. It does not apply or release the brake. If a brake is found to be present, the firmware considers hardware indications regarding the brake circuits (such as open circuit or short circuit). If a brake does not exist, then the firmware ignores the hardware indications since they are irrelevant.

Value	Status
0	Motor brake does not exist.
1	Motor brake exists and brake hardware circuitry checks are enabled.

Enabling the MOTOR.BRAKE (value set to 1) when no motor brake exists creates a fault.

The motor brake is polled every 16 ms.

NOTE

This parameter is automatically configured for Kollmorgen motors when MOTOR.AUTOSSET=1.

Related Topics

7.1 Motor

19.20.3 MOTOR.BRAKEIMM

General Information	
Type	NV Parameter
Description	Brake Immediately: in the case of a drive disable, apply the brake as soon as the power stage disables.
Units	N/A
Range	0 to 1
Default Value	0 (Inactive)
Data Type	Boolean
See Also	N/A
Start Version	M_01-05-11-000

Fieldbus	Index/Subindex	Object Start Version
EtherCAT COE and CANopen	5268h/0	M_01-05-11-000

Description

Sets the brake to apply as soon as the power stage disables. The brake will not apply immediately when the disable command is issued, but at the point when the power stage actually disables. The power stage can disable due to user command (DRV.DIS), digital input, fieldbus, STO, or fault. The point at which the power stage disables depends on the disable mode settings or type of fault for each case.

Value	Description
0	Inactive
1	Brake as soon as power stage disables.

Related Topics

Motor (→ p. 52) | DRV.DISMODE (→ p. 372) | CS.VTHRESH (→ p. 317) | CS.TO (→ p. 316) | MOTOR.TBRAKETO (→ p. 606) | DRV.DISTO (→ p. 375)

19.20.4 MOTOR.BRAKERLS

General Information	
Type	Command
Description	Allows a user to release or apply the motor brake.
Units	N/A
Range	0 to 2
Default Value	0
Data Type	Integer
See Also	N/A
Start Version	M_01-00-00-000

Fieldbus	Index/Subindex	Object Start Version
EtherCAT COE and CANopen	3450h/0	M_01-07-04-000

Description

This command allows a user to release or apply the motor brake.

0 = Drive controls the brake.

1 = Brake is released.

2 = Brake is applied.

NOTE

If a vertical axis is stationary and disabled, toggling the brake with MOTOR.BRAKERLS (→ p. 578) will not reapply the brake until controlled stop conditions are met (the axis actual velocity has been less than CS.VTHRESH (→ p. 317) for CS.TO (→ p. 316) milliseconds). In order for the brake to reapply immediately when commanding MOTOR.BRAKERLS, set CS.VTHRESH to a value greater than the velocity possible by the free falling axis and set CS.TO to 1 millisecond (its minimum value) prior to making the command.

NOTE

A digital input mode can also be used for the same purpose. The two mechanisms are independent.

Related Topics

Motor (→ p. 52)

19.20.5 MOTOR.BRAKESTATE

General Information	
Type	R/O Parameter
Description	Reads the actual status of the motor brake.
Units	N/A
Range	Brake released or not present. Brake applied.
Default Value	Brake applied or not present.
Data Type	String
See Also	N/A
Start Version	M_01-00-00-000

Description

This parameter reads the actual status of the motor brake and can only show two states:

1 = Brake released or not present

2 = Brake applied

Related Topics

Motor (→ p. 52)

19.20.6 MOTOR.CTF0

General Information	
Type	NV Parameter
Description	Sets the thermal constant of the motor coil.
Units	mHz
Range	0.265 to 16,000 mHz
Default Value	10 mHz
Data Type	Float
See Also	N/A
Start Version	M_01-00-00-000

Fieldbus	Index/Subindex	Object Start Version
EtherCAT COE and CANopen	3454h/0	M_01-00-00-000

Description

This parameter is used to configure the thermal constant of the motor coil, which is the break frequency of a single-pole low-pass filter model of the thermal dynamics of the motor coil.

This parameter, together with MOTOR.IPEAK (→ p. 589) and MOTOR.ICONT (→ p. 582), determine the motor foldback parameters IL.MFOLDD (→ p. 553), IL.MFOLDT (→ p. 555), and IL.MFOLDR (→ p. 554).

Calculating MOTOR.CTF0

Given a motor coil/winding thermal time constant T in seconds, then:

$$\text{MOTOR.CTF0} = 1 / (2\pi T)$$

NOTE

This parameter is automatically configured for Kollmorgen motors when MOTOR.AUTOSSET=1.

Related Topics

7.1 Motor

19.20.7 MOTOR.FIELDWEAKENING

General Information	
Type	R/W Parameter
Description	Allows a surface permanent magnet motor to operate as an interior permanent magnet motor.
Units	N/A
Range	0 to 1
Default Value	0
Data Type	Integer
Start Version	M_01-13-02-000

Description

Allows a surface permanent magnet motor (MOTOR.TYPE = 0) to operate as an interior permanent magnet motor (MOTOR.TYPE = 6).

This keyword can only be set when MOTOR.TYPE = 0. Any other MOTOR.TYPE will result in an error and MOTOR.FIELDWEAKENING will not be applied.

Related Topics

7.1 Motor

MOTOR.TYPE (→ p. 611)

19.20.8 MOTOR.ICONT

General Information	
Type	NV Parameter
Description	Sets the motor continuous current.
Units	A
Range	0.1 to 500 A
Default Value	1.0 A
Data Type	Float
See Also	N/A
Start Version	M_01-00-00-000

Fieldbus	Index/Subindex	Object Start Version
EtherCAT COE and CANopen	358Eh/0	M_01-00-00-000

Description

This parameter is used to configure the motor continuous current.

NOTE

This parameter is automatically configured for Kollmorgen motors when MOTOR.AUTOSSET=1.

Related Topics

7.1 Motor

19.20.9 MOTOR.IDDATAVALID

General Information	
Type	R/O Parameter
Description	Reports the status of the motor memory.
Units	N/A
Range	N/A
Default Value	0
Data Type	Integer
See Also	N/A
Start Version	M_01-02-00-000

Description

MOTOR.IDDATAVALID reports the status of the motor memory status.

The valid values for this keyword are the following:

Value	Description
0	Error in identification
1	Success in identification
2	Identification in process
3	Identification not started yet
4	Success recognizing feedback, but failed to varify OEM data integrity

Related Topics

Motor (→ p. 52)

19.20.10 MOTOR.IDMAX

General Information	
Type	NV Parameter
Description	Maximum direct axis current.
Units	Arms
Range	0.2 to 1000
Default Value	0.5 * MOTOR.IPEAK
Data Type	Float
Start Version	M_01-11-00-000

Description

This parameter is supported for IPM motors (MOTOR.TYPE = 6). MOTOR.IDMAX is the maximum motor winding current in the direct (non-torque producing) axis.

NOTE

This parameter is automatically configured for Kollmorgen motors when MOTOR.AUTOSSET = 1.

Related Topics

7.1 Motor | MOTOR.IPEAK (→ p. 589)

19.20.11 MOTOR.IMID

General Information	
Type	R/W
Description	The direct-axis current set point used for induction machine closed-loop control.
Units	Arms
Range	0 to DRIVE.IPEAK
Default Value	0
Data Type	Float
Start Version	M_01-08-00-000

Fieldbus	Index/Subindex	Object Start Version
EtherCAT COE and CANopen	5362h/0	M_01-08-00-000

Description

The value of IL.IMID can be estimated using the motor name plate information.

The following rule should generally be used:

$$I_{d,rms} \cong I_R * \sqrt{1 - (\cos \varphi)^2} * 0.8$$

In which I_d is the value for IL.IMID, the preset rotor flux building current, I_r is the name plate phase current, $\cos \varphi$ is the name plate power factor at rated and operation, and **0.8** is an empirical factor (accounts for the angle error due to voltage drop on the leakage induction).

Related Topics

Motor (→ p. 52)

19.20.12 MOTOR.IMTR

General Information	
Type	R/W
Description	Rotor time constant.
Units	Ms
Range	1 to 16,000
Default Value	100
Data Type	Integer
Start Version	M_01-08-00-000

Fieldbus	Index/Subindex	Object Start Version
EtherCAT COE and CANopen	5360h/0	M_01-08-00-000

Description

The rotor time constant is calculated as the ratio between rotor magnetizing inductance L_m and rotor resistance R_r from the following equivalent circuit of an induction machine.

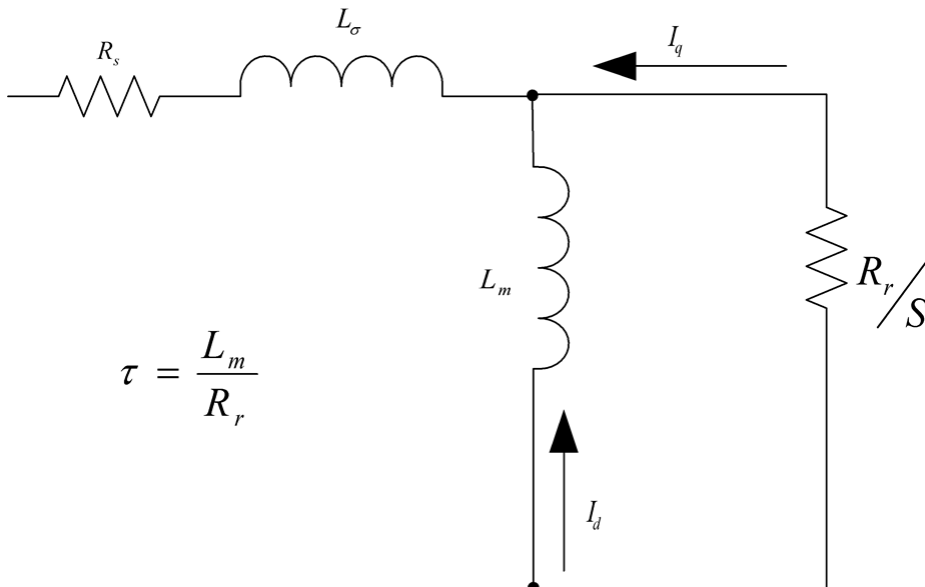

Alternatively, the rotor time constant can be estimated from the rated current, magnetizing current (MOTOR.IMID (→ p. 585)) and rated slip frequency as follows:

$$\tau = \frac{\sqrt{I_{s,rms}^2 - I_{d,rms}^2}}{I_{d,rms} * \omega_{slip}}$$

where $I_{s,rms}$ is the rated current, $I_{d,rms}$ is the rated magnetizing current, and ω_{slip} is the rated slip frequency in rad/s.

NOTE

τ is in seconds for the above formulas. It needs to be converted to ms for the MOTOR.IMTR setting:
 $\text{MOTOR.IMTR}(\text{ms}) = \tau * 1000$

Related Topics

Motor (→ p. 52)

19.20.13 MOTOR.INERTIA

General Information	
Type	NV Parameter
Description	Sets the motor inertia.
Units	kgcm ² for rotary motors kg for linear motors
Range	1 to 200,000 kgcm ² or kg
Default Value	100 kgcm ² or kg
Data Type	Float
See Also	N/A
Start Version	M_01-00-00-000

Fieldbus	Index/Subindex	Object Start Version
EtherCAT COE and CANopen	35ABh/0	M_01-00-00-000

Description

This parameter sets the motor inertia.

NOTE

This parameter is automatically configured for Kollmorgen motors when MOTOR.AUTOSSET=1.

Related Topics

7.1 Motor

19.20.14 MOTOR.IPEAK

General Information	
Type	NV Parameter
Description	Sets the motor peak current.
Units	mA
Range	0.200 to 1,000 A
Default Value	2.000 A
Data Type	Float
See Also	IL.LIMITP (→ p. 552), IL.LIMITN (→ p. 551)
Start Version	M_01-00-00-000

Fieldbus	Index/Subindex	Object Start Version
EtherCAT COE and CANopen	358Fh/0	M_01-00-00-000

Description

This parameter configures the drive for the motor's peak, instantaneous-rated current. MOTOR.IPEAK is used to limit clamp the magnitude of the torque producing q-component current command (IL.CMD (→ p. 527)).

NOTE

This parameter is automatically configured for Kollmorgen motors when MOTOR.AUTOSSET=1.

Related Topics

7.1 Motor

19.20.15 MOTOR.KE

General Information	
Type	NV Parameter
Description	Sets the motor back EMF constant.
Units	V _{peak} /krpm for Rotary Motors V _{peak} /m/s for Linear Motors
Range	0.0 to 100,000
Default Value	0
Data Type	Float
See Also	N/A
Start Version	M_01-03-06-000

Fieldbus	Index/Subindex	Object Start Version
EtherCAT COE and CANopen	5260h/0	M_01-03-06-000

Description

MOTOR.KE defines the back EMF constant for the motor. The back EMF constant defines how much voltage is generated at the motors coils. The relationship between MOTOR.KE and speed is described by the following equation:

$$\text{Coil Voltage} = \text{MOTOR.KE} * \text{VL.FB}$$

VL.FB is in units of krpm for rotary motors and in units of m/s for linear motors.

The maximum speed for interior permanent magnet motors (IPM) is determined by MOTOR.KE and VBUS.VALUE. An overspeed fault is generated if MOTOR.TYPE is set to 6 (IPM) and VL.FB * MOTOR.KE exceeds VBUS.VALUE.

NOTE

This parameter is automatically configured for Kollmorgen motors when MOTOR.AUTOSSET=1.

Related Topics

Motor (→ p. 52) | VL.FB (→ p. 711) | VBUS.VALUE (→ p. 698)

19.20.16 MOTOR.KT

General Information	
Type	NV Parameter
Description	Sets the torque constant of the motor.
Units	Nm/A
Range	0.001 Nm/A to 1,000,000.000 Nm/A for rotary motors. 0.001 Nm/A to 1,000,000.000 N/A for linear motors.
Default Value	0.1 Nm/A
Data Type	Float
See Also	N/A
Start Version	M_01-00-00-000

Fieldbus	Index/Subindex	Object Start Version
EtherCAT COE and CANopen	3593h/0	M_01-00-00-000

Description

This parameter is the torque constant of the motor in Nm/A. The value can be online checked according to the following equation:

$$K_t = 60 \cdot \sqrt{3} \cdot U_i / (2 \cdot \pi \cdot n)$$

Where:

U_i = induced voltage of the motor

n = actual rotor velocity

NOTE

This parameter is automatically configured for Kollmorgen motors when MOTOR.AUTOSSET=1.

Related Topics

7.1 Motor

19.20.17 MOTOR.LDLL

General Information	
Type	NV Parameter
Description	Motor line to line direct axis inductance.
Units	mH
Range	1 to 2 ³¹
Default Value	17.000
Data Type	Float
Start Version	M_01-11-00-000

Descriptio

This parameter is the motor line to line direct axis inductance. It is supported for the IPM motor type (MOTOR.TYPE = 6).

NOTE

This parameter is automatically configured for Kollmorgen motors when MOTOR.AUTOSET = 1.

Related Topics

7.1 Motor | MOTOR.LQLL (→ p. 594) | IL.KPDRATIO (→ p. 546)

19.20.18 MOTOR.LISAT

General Information	
Type	NV Parameter
Description	Motor quadrature axis inductance saturation characteristic.
Units	Arms
Range	0.2A to 2*DRV.IPEAK
Default Value	1000
Data Type	Float
Start Version	M_01-11-00-000

Descriptio

This parameter is the quadrature axis inductance (L_{qll}) saturation characteristic as a function of quadrature current (I_q). It is used for q-axis current loop gain scheduling to maintain bandwidth and stability during q-axis inductance saturation. This value can also be used for q-axis flux estimation during field weakening, especially for IPM motors (MOTOR.TYPE = 6).

NOTE

This parameter is automatically configured for Kollmorgen motors when MOTOR.AUTOSSET = 1.

Related Topics

7.1 Motor | MOTOR.LQLL (→ p. 594)

19.20.19 MOTOR.LQLL

General Information	
Type	NV Parameter
Description	Sets the line-to-line motor Lq.
Units	mH
Range	1 to 2 ³² mH
Default Value	17.000 mH
Data Type	Float
See Also	N/A
Start Version	M_01-00-00-000

Fieldbus	Index/Subindex	Object Start Version
EtherCAT COE and CANopen	3455h/0	M_01-00-00-000

Description

This parameter is used to configure the motor line-to-line inductance.

NOTE

This parameter is automatically configured for Kollmorgen motors when MOTOR.AUTOSSET=1.

Related Topics

7.1 Motor

19.20.20 MOTOR.NAME

General Information	
Type	NV Parameter
Description	Sets the motor name.
Units	N/A
Range	11 chars
Default Value	N/A
Data Type	String
See Also	N/A
Start Version	M_01-00-00-000

Description

This parameter is used to set the motor name.

NOTE

This parameter is automatically configured for Kollmorgen motors when MOTOR.AUTOSSET=1.

Related Topics

Motor (→ p. 52)

19.20.21 MOTOR.PHASE

General Information	
Type	NV Parameter
Description	Sets the motor phase.
Units	Electrical degrees
Range	0 to 360°
Default Value	0°
Data Type	Integer
See Also	N/A
Start Version	M_01-00-00-000

Fieldbus	Index/Subindex	Object Start Version
EtherCAT COE and CANopen	359Ch/0	M_01-00-00-000

Description

This parameter sets the motor phase.

NOTE

If MOTOR.AUTOSSET = 1 and FB1.MEMVER > 0.01, this parameter will be automatically configured for Kollmorgen motors.

Related Topics

7.1 Motor

19.20.22 MOTOR.PHSADV1

General Information	
Type	NV Parameter
Description	First order phase advance polynomial coefficient.
Units	N/A
Range	-1.0 to 1.0
Default Value	0
Data Type	Float
Start Version	M_01-11-00-000

Description

This parameter is supported for IPM motors (MOTOR.TYPE = 6). MOTOR.PHSADV1 is the first order polynomial coefficient used to determine the direct axis current command for commutation phase advance, according to the equation:

$$IdCmd(I_p) = PHSADV2 * I_p^2 + PHSADV1 * I_p$$

where I_p is the magnitude of the motor phase current:

$$I_p = \sqrt{Id^2 + Iq^2}$$

NOTE

This parameter is automatically configured for Kollmorgen motors when MOTOR.AUTOSSET=1.

Related Topics

7.1 Motor | MOTOR.PHSADV2 (→ p. 598)

19.20.23 MOTOR.PHSADV2

General Information	
Type	NV Parameter
Description	Second order phase advance polynomial coefficient.
Units	N/A
Range	-1.0 to 1.0
Default Value	0
Data Type	Float
Start Version	M_01-11-00-000

Description

This parameter is supported for IPM motors (MOTOR.TYPE = 6). MOTOR.PHSADV2 is the second order polynomial coefficient used to determine the direct axis current command for commutation phase advance, according to the equation:

$$I_dCmd(I_p) = PHSADV2 * I_p^2 + PHSADV1 * I_p$$

where I_p is the magnitude of the motor phase current:

$$I_p = \sqrt{I_d^2 + I_q^2}$$

NOTE

This parameter is automatically configured for Kollmorgen motors when MOTOR.AUTOSSET=1.

Related Topics

7.1 Motor | MOTOR.PHSADV1 (→ p. 597)

19.20.24 MOTOR.PITCH

General Information	
Type	NV Parameter
Description	Sets the motor pitch.
Units	µm
Range	1,000 to 1,000,000 µm
Default Value	1.000 µm
Data Type	Integer
See Also	N/A
Start Version	M_01-00-00-000

Fieldbus	Index/Subindex	Object Start Version
EtherCAT COE and CANopen	50FBh/0	M_01-00-00-000

Description

This parameter defines the pole-to-pair pitch for the linear motor in micrometers.

Related Topics

Motor (→ p. 52)

19.20.25 MOTOR.POLES

General Information	
Type	NV Parameter
Description	Sets the number of motor poles.
Units	N/A
Range	0 to 510
Default Value	6
Data Type	Integer
See Also	FB1.POLES (→ p. 467)
Start Version	M_01-00-00-000

Fieldbus	Index/Subindex	Object Start Version
EtherCAT COE and CANopen	359Dh/0	M_01-00-00-000

Description

MOTOR.POLES sets the number of motor poles. This command is used for commutation control and represents the number of individual magnetic poles of the motor (not pole pairs). A motor's magnetic poles range from 0 to 510, which corresponds to 0 to 255 magnetic pole pairs. The division value of motor poles (MOTOR.POLES) and feedback poles (FB1.POLES) must be an integer when setting drive to enable, otherwise a fault is issued.

NOTE

This parameter is automatically configured for Kollmorgen motors when MOTOR.AUTOSSET=1.

Related Topics

7.1 Motor

19.20.26 MOTOR.R

General Information	
Type	NV Parameter
Description	Sets the stator winding resistance phase-phase in ohms.
Units	Ω
Range	0.001 to 650 Ω
Default Value	10 Ω
Data Type	Float
See Also	N/A
Start Version	M_01-00-00-000

Fieldbus	Index/Subindex	Object Start Version
EtherCAT COE and CANopen	3456h/0	M_01-00-00-000

Description

MOTOR.R sets the stator winding resistance phase-to-phase in ohms.

NOTE

This parameter is automatically configured for Kollmorgen motors when MOTOR.AUTOSSET=1.

Related Topics

7.1 Motor

19.20.27 MOTOR.RTYPE

General Information	
Type	NV Parameter
Description	Defines the type of thermal resistor inside the motor.
Units	N/A
Range	0 to 1 For firmware version 01-10-02-000 and later, range is 0 to 255.
Default Value	0
Data Type	Integer
Start Version	M_01-00-00-000

Fieldbus	Index/Subindex	Object Start Version
EtherCAT COE and CANopen	50FEh/0	M_01-00-00-000

Description

This parameter defines the type of thermal resistor used inside of the motor to measure motor temperature.

For firmware versions prior to 01-10-02-000, parameter range is 0 to 1.

0 = PTC

1 = NTC

For firmware versions 01-10-02-000 and later, parameter range is 0 to 255.

0 = Single PTC Thermistor

1 = Single NTC Thermistor

2 = KTY83-110 Thermistor

3 = KTY84-130 Thermistor

4 = PTC + KTY83-110 Thermistors

5 = Thermal switch

255 = No thermal sensor in the motor

NOTE

For firmware versions 01-09-00-000 and later, this parameter is automatically configured for Kollmorgen motors when MOTOR.AUTOSSET = 1.

Related Topics

Motor (→ p. 52)

19.20.28 MOTOR.SUPPORTEDPARAMS

General Information	
Type	R/O Parameter
Description	Lists MOTOR parameters supported by configured motor type.
Units	N/A
Range	N/A
Default Value	N/A
Data Type	String
Start Version	M_01-11-00-000

Description

This parameter lists all the MOTOR parameters that are supported for the motor type selected by the MOTOR.TYPE parameter.

Example

The following output is produced for surface permanent magnet motors (MOTOR.TYPE = 0).

-> MOTOR.SUPPORTEDPARAMS

```
MOTOR.CTF0
MOTOR.ICONT
MOTOR.INERTIA
MOTOR.IPEAK
MOTOR.KE
MOTOR.KT
MOTOR.LISAT
MOTOR.LQLL
MOTOR.PHASE
MOTOR.POLES
MOTOR.R
MOTOR.VMAX
MOTOR.VOLTMAX
```

Related Topics

7.1 Motor | MOTOR.TYPE (→ p. 611)

19.20.29 MOTOR.TBRAKEAPP

General Information	
Type	NV Parameter
Description	The delay time used for applying the motor brake.
Units	ms
Range	0 to 1,000 ms
Default Value	75 ms
Data Type	Integer
See Also	N/A
Start Version	M_01-00-00-000

Fieldbus	Index/Subindex	Object Start Version
EtherCAT COE and CANopen	366Eh/0	M_01-00-00-000

Description

This parameter is used to configure the mechanical delay required for the motor brake to close. The AKD PDMM will servo to hold position for the time set, allowing the brake to apply.

NOTE

If MOTOR.AUTOSSET = 1 and FB1.MEMVER > 0.01, this parameter will be automatically configured for Kollmorgen motors.

Related Topics

7.1 Motor

19.20.30 MOTOR.TBRAKERLS

General Information	
Type	NV Parameter
Description	The delay time used for releasing the motor brake.
Units	ms
Range	0 to 1,000 ms
Default Value	75 ms
Data Type	Integer
See Also	N/A
Start Version	M_01-00-00-000

Fieldbus	Index/Subindex	Object Start Version
EtherCAT COE and CANopen	366Fh/0	M_01-00-00-000

Description

This parameter is used to configure the mechanical delay when releasing the motor brake. MOTOR.TBRAKERLS is a time delay that is applied when a brake exists and the drive is enabled. When the drive is enabled, the brake is commanded to release and, during the MOTOR.TBRAKERLS period of time, the drive does not accept a motion command. This delay allows the brake to fully release before the drive begins a new motion.

NOTE

If MOTOR.AUTOSSET = 1 and FB1.MEMVER > 0.01, this parameter will be automatically configured for Kollmorgen motors.

Related Topics

7.1 Motor

19.20.31 MOTOR.TBRAKETO

General Information	
Type	NV Parameter
Description	Brake apply timeout for vertical axis.
Units	Milliseconds
Range	-1 to 30,000
Default Value	-1 (function disabled)
Data Type	Integer
See Also	CS.VTHRESH (→ p. 317), CS.TO (→ p. 316), DRV.DISTO (→ p. 375)
Start Version	01-05-07-000

Fieldbus	Index/Subindex	Object Start Version
EtherCAT COE and CANopen	51EFh/0	M_01-05-07-000

Description

When a drive is disabled (due to user command, digital input, or fault), the brake will normally not be applied until velocity has fallen below CS.VTHRESH (→ p. 317). In some instances, such as a vertical axis, it may be desirable to apply the brake regardless of velocity.

MOTOR.TBRAKETO sets the maximum time allowed to pass between drive disable and application of the motor brake. After this time, the brake will be applied even if velocity is higher than CS.VTHRESH (→ p. 317).

To disable the timer, set the value to -1.

NOTE

Prior to version 01-05-07-000, this timeout was only applied when the Hardware Enable was deactivated and the default was 30,000. From 01-05-07-000 on this timeout is applied in all conditions and the default is -1.

19.20.32 MOTOR.TEMP

General Information	
Type	R/O Parameter
Description	Reads the motor temperature represented as the resistance of the motor PTC or NTC.
Units	Ω
Range	0 to $2^{32} \Omega$
Default Value	N/A
Data Type	Integer
See Also	N/A
Start Version	M_01-00-00-000

Fieldbus	Index/Subindex	Object Start Version
EtherCAT COE and CANopen	3612h/0	M_01-00-00-000

Description

This parameter returns the motor temperature, which is represented as the resistance of the motor's PTC or NTC.

Related Topics

Motor ([→ p. 52](#)) | MOTOR.RTYPE ([→ p. 602](#))

19.20.33 MOTOR.TEMPC

General Information	
Type	R/O Parameter
Description	Reads the motor temperature in degrees Celsius.
Units	Degrees Celsius
Range	-2^{15} to 2^{15}
Default Value	N/A
Data Type	Integer
Start Version	M_01-10-04-000

Description

When the motor has a thermistor with linear characteristics (MOTOR.RTYPE = 2, 3 or 4), MOTOR.TEMPC returns the motor temperature in degrees Celsius, which is calculated from the resistance of the motor thermistor.

There is no algorithm to convert from resistance to degrees Celsius for non-linear thermistors. In this case, MOTOR.TEMPC returns -32,768 which is an invalid temperature.

Related Topics

7.1 Motor | MOTOR.TEMP (→ p. 607) | MOTOR.RTYPE (→ p. 602)

19.20.34 MOTOR.TEMPFAULT

General Information	
Type	NV Parameter
Description	Sets the motor temperature fault level.
Units	Ω
Range	0 to 2,000,000,000 Ω
Default Value	0 Ω = switched off
Data Type	Integer
See Also	MOTOR.TEMP (→ p. 607)
Start Version	M_01-00-00-000

Fieldbus	Index/Subindex	Object Start Version
EtherCAT COE and CANopen	3586h/0	M_01-00-00-000

Description

This parameter is used to configure the motor temperature fault level as a resistance threshold of the motor thermal sensor.

A zero value prevents any fault from being issued.

NOTE

For firmware versions 01-09-00-000 and later, this parameter is automatically configured for Kollmorgen motors when MOTOR.AUTOSSET = 1.

Related Topics

7.1 Motor

19.20.35 MOTOR.TEMPWARN

General Information	
Type	NV Parameter
Description	Sets the motor temperature warning level.
Units	Ω
Range	0 to 2,000,000,000 Ω
Default Value	0 Ω = switched off
Data Type	Integer
See Also	MOTOR.TEMP (→ p. 607)
Start Version	M_01-00-00-000

Fieldbus	Index/Subindex	Object Start Version
EtherCAT COE and CANopen	3453h/0	M_01-00-00-000

Description

This parameter is used to configure the motor temperature warning level as a resistance threshold of the motor PTC.

A zero value prevents any warning from being created.

Related Topics

7.1 Motor

19.20.36 MOTOR.TYPE

General Information	
Type	NV Parameter
Description	Sets the motor type.
Units	N/A
Range	0, 1, 2, 4, 8
Default Value	0
Data Type	Integer
See Also	N/A
Start Version	M_01-00-00-000

Fieldbus	Index/Subindex	Object Start Version
EtherCAT COE and CANopen	5104h/0	M_01-00-00-000

Description

MOTOR.TYPE sets the drive control algorithms to different motor types as follows:

0 = Rotary motor

1 = Linear motor

2 = Induction Motor V/f Open Loop Control

4 = Induction Motor Closed Loop Control

8 = Rotary brush motor

The following table shows which MOTOR parameters must be configured for either permanent magnet, induction motor v/f open loop, or induction motor closed loop motor types.

NOTE

ECCN 3A255 imposes special limitations on operating speed for induction motors. See ECCN 3A225 Limitations for Induction Motors (→ p. 1).

Keyword	Permanent Magnet	Induction Motor v/f Open Loop	Induction Motor Closed Loop
MOTOR.NAME (→ p. 595)	Yes	Yes	Yes
MOTOR.TYPE	Yes	Yes	Yes
MOTOR.AUTOSET (→ p. 574)	Yes	No	Yes
MOTOR.IPEAK (→ p. 589)	Yes	Yes	Yes
MOTOR.ICONT (→ p. 582)	Yes	Yes	Yes
MOTOR.INERTIA (→ p. 588)	Yes	Yes	Yes
MOTOR.KT (→ p. 591)	Yes	No	No
MOTOR.LQLL (→ p. 594)	Yes	No	Yes

Keyword	Permanent Magnet	Induction Motor v/f Open Loop	Induction Motor Closed Loop
MOTOR.POLES (→ p. 600)	Yes	Yes	Yes
MOTOR.VMAX (→ p. 613)	Yes	Yes	Yes
MOTOR.R (→ p. 601)	Yes	Yes	Yes
MOTOR.VOLTMAX (→ p. 614)	Yes	Yes	Yes
MOTOR.PHASE (→ p. 596)	Yes	No	No
MOTOR.CTF0 (→ p. 580)	Yes	Yes	Yes
MOTOR.KE (→ p. 590)	Yes	No	No
MOTOR.IMTR (→ p. 586)	No	No	Yes
MOTOR.IMID (→ p. 585)	No	No	Yes
MOTOR.VOLTRATED (→ p. 616)	No	Yes	No
MOTOR.VRATED (→ p. 617)	No	Yes	No
MOTOR.VOLTMIN (→ p. 615)	No	Yes	No

Related Topics

Motor (→ p. 52)

19.20.37 MOTOR.VMAX

General Information	
Type	NV Parameter
Description	Sets the maximum motor speed.
Units	rpm
Range	100 to 40,000 rpm
Default Value	3,000 rpm
Data Type	Integer
Start Version	M_01-00-00-000

Fieldbus	Index/Subindex	Object Start Version
EtherCAT COE and CANopen	35A3h/0	M_01-00-00-000

Description

This parameter sets the maximum motor mechanical speed. The value $1.2 \times \text{MOTOR.VMAX}$ becomes the overall overspeed fault threshold (VL.VFTHRESH) if it is less than the user overspeed fault threshold (VL.THRESH), and for MOTOR.TYPE = 6 if it is less than the motor back EMF overspeed threshold $((1.02 \times 1000 \times \text{VBUS.OVFTHRESH}) / (\text{MOTOR.KE} \times \sqrt{2}))$.

Related Topics

7.1 Motor | VL.THRESH (→ p. 731) | VL.VFTHRESH (→ p. 733)

19.20.38 MOTOR.VOLTMAX

General Information	
Type	NV Parameter
Description	Sets the motor maximum voltage.
Units	Vrms
Range	110 to 900 Vrms
Default Value	230 Vrms
Data Type	Integer
See Also	N/A
Start Version	M_01-00-00-000

Fieldbus	Index/Subindex	Object Start Version
EtherCAT COE and CANopen	3452h/0	M_01-00-00-000

Description

This parameter sets the rated nominal operating voltage for the motor insulation system in Vrms. For instance, if a motor rated for a 480 Vac supply is connected to the drive, then MOTOR.VOLTMAX should be set to 480.

This value also sets regen resistor and over voltage thresholds in the drive to acceptable values for the motor so that the motor windings are not damaged. Since VOLTMAX is specified as nominal RMS Voltage, the drive will fault if the DC bus VBUS.VALUE exceeds 2x VOLTMAX which provides sufficient margin to be safe and to prevent false trips.

Related Topics

7.1 Motor

19.20.39 MOTOR.VOLTMIN

General Information	
Type	NV Parameter
Description	Sets the minimum voltage for V/f control.
Units	%
Range	0 to 100%
Default Value	2%
Data Type	U16
See Also	MOTOR.VRATED (→ p. 617), MOTOR.VOLTRATED (→ p. 616)
Start Version	

Fieldbus	Index/Subindex	Object Start Version
EtherCAT COE and CANopen	3457h/3	M_01-00-00-000

Description

This parameter configures the drive for the induction motor's minimum voltage at standstill. It is given as a percentage (%) of the motor's rated voltage. MOTOR.VOLTMIN is used to calculate the constant volts per Hertz characteristics of the drive and motor and should be set to a value that generates a current of about 40% of the rated current at standstill.

Related Topics

7.1 Motor

19.20.40 MOTOR.VOLTRATED

General Information	
Type	NV Parameter
Description	Sets the motor rated voltage.
Units	V
Range	50 to 1,000 V
Default Value	230 V
Data Type	U16
See Also	MOTOR.VRATED (→ p. 617), MOTOR.VOLTMIN (→ p. 615)
Start Version	M_01-03-00-000

Fieldbus	Index/Subindex	Object Start Version
EtherCAT COE and CANopen	3457h/2	M_01-03-00-000

Description

This parameter configures the drive for the induction motor's rated voltage as indicated on the nameplate. MOTOR.VOLTRATED is used to calculate the constant Volts per Hertz characteristics of the drive and motor.

NOTE

If MOTOR.AUTOSET = 1 and FB1.MEMVER > 0.01, this parameter will be automatically configured for Kollmorgen motors.

Related Topics

Motor (→ p. 52)

19.20.41 MOTOR.VRATED

General Information	
Type	NV Parameter
Description	Sets the motor rated velocity (not maximum velocity)
Units	Depends on UNIT.VROTARY (pg 1) or UNIT.VLINEAR (pg 1) Rotary: rpm, rps, deg/s, custom units/s, rad/s Linear: counts/s, mm/s, $\mu\text{m/s}$, custom units/s
Range	Rotary: 0.000 to 15,000.000 rpm 0.000 to 250.000 rps 0.000 to 90,000.000 deg/s 0.000 to 1,250.000 custom units/s 0.000 to 1,570.796 rad/s Linear: 0.000 to 1,073,741,824,000.000 counts/s 0.000 to 8,000.000 mm/s 0.000 to 8,000,000.000 $\mu\text{m/s}$ 0.000 to 1,250.000 custom units/s
Default Value	0 rpm
Data Type	U16
See Also	MOTOR.VOLTRATED (→ p. 616), MOTOR.VOLTMIN (→ p. 615)
Start Version	M_01-03-00-000

Fieldbus	Index/Subindex	Object Start Version
EtherCAT COE and CANopen	3457h/1	M_01-03-00-000

Description

This parameter configures the drive for the rated velocity of the induction motor as indicated on the nameplate. MOTOR.VRATED is used to calculate the constant volts per Hertz characteristics of the drive and motor.

NOTE

If MOTOR.AUTOSET = 1 and FB1.MEMVER > 0.01, this parameter will be automatically configured for Kollmorgen motors.

Related Topics

Motor (→ p. 52)

19.21 PL Parameters

This section describes the PL parameters.

19.21.1 PL.CMD	619
19.21.2 PL.ERR	620
19.21.3 PL.ERRFTHRESH	621
19.21.4 PL.ERRMODE	623
19.21.5 PL.ERRWTHRESH	624
19.21.6 PL.FB	625
19.21.7 PL.FBSOURCE	626
19.21.8 PL.FILTERTIME	627
19.21.9 PL.INTINMAX	628
19.21.10 PL.INTOUTMAX	630
19.21.11 PL.KI	632
19.21.12 PL.KP	633
19.21.13 PL.PDELAY	634

19.21.1 PL.CMD

General Information	
Type	R/O Parameter
Description	Reads the position command directly from the entry to the position loop.
Units	Depends on UNIT.PLINEAR (pg 1) or UNIT.PROTARY (pg 1) Rotary: counts, rad, deg, (custom units), 16-bit counts Linear: counts, mm, μ m, (custom units), 16-bit counts
Range	N/A
Default Value	N/A
Data Type	Float
See Also	PL.FB (→ p. 625)
Start Version	M_01-00-00-000

Description

PL.CMD reads the position command as it is received in the position loop entry.

Related Topics

PL.ERR (→ p. 620) | PL.ERRFTHRESH (→ p. 621) | PL.ERRMODE (→ p. 623) | PL.ERRWTHRESH (→ p. 624)

1 Position Loop

19.21.2 PL.ERR

General Information	
Type	R/O Parameter
Description	Reads the position error present when the drive is controlling the position loop.
Units	counts, rad, deg, (custom units)
Range	N/A
Default Value	N/A
Data Type	Float
See Also	PL.FB (→ p. 625)
Start Version	M_01-00-00-000

Fieldbus	Index/Subindex	Object Start Version
EtherCAT COE and CANopen	35C5h/0 60F4h/0	M_01-00-00-000

Description

PL.ERR reads the position error present when the drive is controlling the position loop. PL.ERR is the difference between the actual position of the motor shaft (PL.FB (→ p. 625)) and the commanded position of the drive (PL.CMD (→ p. 619)). If the drive is not in the position operating mode (DRV.OPMODE (→ p. 414) = 2), then the PL.ERR value is not generated by the drive and this parameter is read as 0.

Related Topics

PL.ERRFTHRESH (→ p. 621) | PL.ERRMODE (→ p. 623) | PL.ERRWTHRESH (→ p. 624)

1 Position Loop

19.21.3 PL.ERRFTHRESH

General Information	
Type	NV Parameter
Description	Sets the maximum position error.
Units	Depends UNIT.ACCROTARY (pg 1) on or UNIT.ACCLINEAR (pg 1) Rotary: counts, rad, deg, (custom units), 16-bit counts Linear: counts, mm, μm , (custom units), 16-bit counts
Range	Rotary: 0.000 to 5,123,372,000,000,005.000 counts 0.000 to 7,495,067.136 rad 0.000 to 429,436,076.032 deg 0.000 to 5,964,389.888 (custom units) 0.000 to 78,176,452,636.718 16-bit counts Linear: 0.000 to 5,123,372,000,000,005.000 counts 0.000 to 1,192,877.952*MOTOR.PITCH (→ p. 599) mm 0.000 to 1,192,878,014.464*MOTOR.PITCH (→ p. 599) μm 0.000 to 5,964,389.888 (custom units) 0.000 to 78,176,452,636.718 16-bit counts
Default Value	Rotary: 42,949,672,960.000 counts 62.832 rad 3,600.000 deg 50.000 (custom units) 655,360.000 16-bit counts Linear: 42,949,672,960.000 counts 10.000*MOTOR.PITCHMOTOR.PITCH (→ p. 599)mm 10,000.000*MOTOR.PITCH μm 50.000 (custom units) 655,360.000 16-bit counts
Data Type	Float
See Also	PL.ERR
Start Version	M_01-00-00-000

Fieldbus	Index/Subindex	Object Start Version
EtherCAT COE and CANopen	35C7h/0 6065h/0	M_01-00-00-000

Description

This parameter sets the maximum position error. If the position error PL.ERR (→ p. 620) is larger than PL.ERRFTHRESH the drive generates a fault. If PL.ERRFTHRESH is set to 0, the maximum position error is ignored.

Example

Set position rotary units to 2 (degrees). Setting PL.ERRFTHRESH to 1000 states that if the position error is larger than 1000 degrees, the drive will generate a fault.

UNIT.PROTARY 2

PL.ERRFTHRESH 1000

Related Topics

PL.ERR (→ p. 620) | PL.ERRMODE (→ p. 623) | PL.ERRWTHRESH (→ p. 624)

1 Position Loop

19.21.4 PL.ERRMODE

General Information	
Type	NV Parameter
Description	Sets the type of following error warning and fault usage.
Units	0- Standard following error 1-Enhanced following error
Range	0 to 1
Default Value	0
Data Type	Boolean
See Also	PL.ERR (→ p. 620), PL.ERRFTHRESH (→ p. 621), PL.ERRWTHRESH (→ p. 624)
Start Version	M_01-02-09-000

Fieldbus	Index/Subindex	Object Start Version
EtherCAT COE and CANopen	5121h/0	M_01-02-09-000

Description

PL.ERRMODE sets the type of following error warning and fault usage.

Mode 0 - following error magnitude fault

In Mode 0, the values of PL.ERRFTHRESH and PL.ERRWTHRESH are compared against the value of PL.ERR. If the absolute value of PL.ERR is larger than PL.ERRWTHRESH, then a warning is generated. If the absolute value of PL.ERR is larger than PL.ERRFTHRESH, then a fault is generated.

Mode 1 - deviation from predicted trajectory fault

In Mode 1, the values of PL.ERRFTHRESH and PL.ERRWTHRESH are compared against the following value:

$$\langle \text{error} \rangle = \text{abs}(\text{PL.ERR} - [(\text{VL.CMD} - 1 * \text{VL.FF}) / \text{PL.KP}])$$

If the absolute value of $\langle \text{error} \rangle$ is larger than PL.ERRWTHRESH for a consecutive period of 100 ms, then a warning is generated. If the absolute value of $\langle \text{error} \rangle$ is larger than PL.ERRFTHRESH for a consecutive period of 100 ms, then a fault is generated.

In mode 1, if PL.KI is not 0 then the following error prediction mechanism is turned off. When the drive is disabled, the following error limit tests are turned off and the warnings are cleared. A value of 0 in PL.ERRFTHRESH or PL.ERRWTHRESH disables the respective functionality.

Example

Assuming

PL.ERRMODE = 0, PL.ERRFTHRESH=1.2, PL.ERRWTHRESH=1, then PL.ERR reads 1.1.

In this case the warning is generated, but the fault is not.

Assuming PL.ERRMODE = 0, PL.ERRFTHRESH=1.2, PL.ERRWTHRESH=1, then PL.ERR reads 1.3.

In this case the warning is generated, as well as the fault.

Related Topics

PL.ERR (→ p. 620) | PL.ERRFTHRESH (→ p. 621) | PL.ERRWTHRESH (→ p. 624)

1 Position Loop

19.21.5 PL.ERRWTHRESH

General Information	
Type	NV Parameter
Description	Sets the position error warning level.
Units	Depends on UNIT.PLINEAR (pg 1) or UNIT.PROTARY (pg 1) Rotary: counts, rad, deg, (custom units), 16-bit counts Linear: counts, mm, μm , (custom units), 16-bit counts
Range	Rotary: 0.000 to 5,123,372,000,000,005.000 counts 0.000 to 7,495,067.136 rad 0.000 to 429,436,076.032 deg 0.000 to 5,964,389.888 (custom units) 0.000 to 78,176,452,636.718 16-bit counts Linear: 0.000 to 5,123,372,000,000,005.000 counts 0.000 to 1,192,877.952*MOTOR.PITCH (\rightarrow p. 599) mm 0.000 to 1,192,878,014.464*MOTOR.PITCH (\rightarrow p. 599) μm 0.000 to 5,964,389.888 (custom units) 0.000 to 78,176,452,636.718 16-bit counts
Default Value	0.000 deg
Data Type	Float
See Also	PL.ERR (\rightarrow p. 620)
Start Version	M_01-00-00-000

Fieldbus	Index/Subindex	Object Start Version
EtherCAT COE and CANopen	3483h/0	M_01-00-00-000

Description

If this value is not equal 0 and the position error PL.ERR (\rightarrow p. 620) is larger than this value, the drive will generate a warning.

If PL.ERRWTHRESH is set to 0 the warning is not issued.

Example

Set position rotary units to 2 degrees. If you set PL.ERRWTHRESH to 100 and the position error is larger than 100 degrees, then the drive will generate a warning.

```
UNIT.PROTARY 2
```

```
PL.ERRWTHRESH 100
```

Related Topics

PL.ERR (\rightarrow p. 620) | PL.ERRFTHRESH (\rightarrow p. 621) | PL.ERRMODE (\rightarrow p. 623)

1 Position Loop

19.21.6 PL.FB

General Information	
Type	R/O Parameter
Description	Reads the position feedback value.
Units	Depends on UNIT.PLINEAR (pg 1) or UNIT.PROTARY (pg 1) Rotary: counts, rad, deg, (custom units), 16-bit counts Linear: counts, mm, μ m, (custom units), 16-bit counts
Range	N/A
Default Value	N/A
Data Type	Float
See Also	FB1.OFFSET
Start Version	M_01-00-00-000

Fieldbus	Index/Subindex	Object Start Version
EtherCAT COE and CANopen	6064h/0	M_01-00-00-000

Description

PL.FB returns the position feedback value.

Note that this value is not the pure feedback value read from the feedback device, but also includes the value of the FB1.OFFSET and an internal offset set automatically by the FW when a homing switch is actuated.

Related Topics

PL.ERR (→ p. 620) | PL.ERRFTHRESH (→ p. 621) | PL.ERRMODE (→ p. 623) | PL.ERRWTHRESH (→ p. 624)

1 Position Loop

19.21.7 PL.FBSOURCE

General Information	
Type	NV Parameter
Description	Sets the feedback source for the position loop.
Units	N/A
Range	Range will differ depending on drive model. 0 to 1 (for AKD PDMM-x-xxxxx-NAxx-xxxx) 0 to 2 (for AKD PDMM-x-xxxxx-NBxx-xxxx)
Default Value	0
Data Type	Integer
Start Version	M_01-00-00-000

Fieldbus	Index/Subindex	Object Start Version
EtherCAT COE and CANopen	5128h/0	M_01-00-00-000

Description

This parameter determines the feedback source that the position loop uses. A value of 0 for this parameter selects the primary feedback, a value of 1 selects the secondary feedback. If you use the secondary feedback as the source for the position loop, then FB2.MODE mode should be set as 0 (A/B signals). A/B signals are the only supported feedback type as secondary feedback into the position loop. Other settings for FB2.MODE are intended as pulse inputs or a gearing command when PL.FBSOURCE remains 0.

0	Primary Feedback connected to X10.
1	Secondary Feedback (DRV.HANDWHEEL) connected to X7 or X9.
2	Tertiary Feedback connected to X9 (only supported with AKD PDMM-x-xxxxx-NBxx-xxxx).

Related Topics

PL.ERR (→ p. 620) | PL.ERRFTHRESH (→ p. 621) | PL.ERRMODE (→ p. 623) | PL.ERRWTHRESH (→ p. 624)

1 Position Loop

19.21.8 PL.FILTERTIME

General Information	
Type	R/W Parameter
Description	Sets the position command filter period.
Units	Milliseconds
Range	0, 0.5, 1, 2, 4, 8, 16, 32, 64, 128, 256, 512
Default Value	0
Data Type	Float
Start Version	M_01-08-01-000

Description

PL.FILTERTIME sets the period of a "boxcar" moving average filter on the position command. When PL.FILTERTIME is greater than zero, the filter is active.

The moving average filter is applied to all Command Source types, but only active when the AKD PDMM is in Position mode.

This feature is typically used for smoothing abrupt changes in position command, or filtering coarse command steps from low resolution controllers, or electronic gearing.

NOTE

When the filter is on (PL.FILTERTIME > 0), total motion commanded will be delayed by the period the filter is set to.

19.21.9 PL.INTINMAX

General Information	
Type	NV Parameter
Description	Limits the input of the position loop integrator by setting the input saturation.
Units	Depends on UNIT.PLINEAR (pg 1) or UNIT.PROTARY (pg 1) Rotary: counts, rad, deg, (custom units), 16-bit counts Linear: counts, mm, μm , (custom units), 16-bit counts
Range	Rotary: 0.000 to 18,446,744,073,709.000 counts 0.000 to 26,986.052 rad 0.000 to 1,546,188.288 deg 0.000 to 21,474.836 (custom units) 0.000 to 281,474,976.710 16-bit counts Linear: 0.000 to 18,446,744,073,709.000 counts 0.000 to 4,294.968*MOTOR.PITCH (→ p. 599) mm 0.000 to 4,294,967.296*MOTOR.PITCH (→ p. 599) μm 0.000 to 21,474.836 (custom units) 0.000 to 281,474,976.710 16-bit counts
Default Value	Rotary: 3,999,989,760.000 counts 5.852 rad 335.275 deg 4.657 (custom units) 61,035.000 16-bit counts Linear: 3,999,989,760.000 counts 0MOTOR.PITCH (→ p. 599) mm 9MOTOR.PITCH (→ p. 599) μm 4.657 (custom units) 61,035.000 16-bit counts
Data Type	Float
See Also	PL.FB
Start Version	M_01-00-00-000

Fieldbus	Index/Subindex	Object Start Version
EtherCAT COE and CANopen	3481h/1	M_01-00-00-000

Description

PL.INTINMAX limits the input of the position loop integrator by setting the input saturation. When used in concert with PL.INSATOUT, this variable allows you to make the position loop integrator effective near the target position. Far from the target position, however, the integrator is not dominant in the loop dynamics.

Related Topics

PL.ERR (→ p. 620) | PL.ERRFTHRESH (→ p. 621) | PL.ERRMODE (→ p. 623) | PL.ERRWTHRESH (→ p. 624)

1 Position Loop

19.21.10 PL.INTOUTMAX

General Information	
Type	NV Parameter
Description	Limits the output of the position loop integrator by setting the output saturation.
Units	Depends on UNIT.PLINEAR (pg 1) or UNIT.PROTARY (pg 1) Rotary: counts, rad, deg, (custom units), 16-bit counts Linear: counts, mm, μm , (custom units), 16-bit counts
Range	Rotary: 0.000 to 18,446,744,073,709.000 counts 0.000 to 26,986.052 rad 0.000 to 1,546,188.288 deg 0.000 to 21,474.836 (custom units) 0.000 to 281,474,976.710 counts 16 bit Linear: 0.000 to 18,446,744,073,709.000 counts 0.000 to 4,294.968*MOTOR.PITCH (\rightarrow p. 599) mm 0.000 to 4,294,967.296*MOTOR.PITCH μm 0.000 to 21,474.836 (custom units) 0.000 to 281,474,976.710 16-bit counts
Default Value	Rotary: 3,999,989,760.000 counts 5.852 rad 335.275 deg 4.657 (custom units) 61,035.000 16-bit counts Linear: 3,999,989,760.000 counts 0MOTOR.PITCH (\rightarrow p. 599) mm 9MOTOR.PITCH (\rightarrow p. 599) μm 4.657 (custom units) 61,035.000 16-bit counts
Data Type	Float
See Also	PL.INTINMAX
Start Version	M_01-00-00-000

Fieldbus	Index/Subindex	Object Start Version
EtherCAT COE and CANopen	3481h/2	M_01-00-00-000

Description

PL.INTOUTMAX limits the output of the position loop integrator by setting the output saturation.

When used in concert with PL.INTINMAX, this variable allows you to make the position loop integrator effective near the target position. Far from the target position, however, the integrator is not dominant in the loop dynamics.

Related Topics

PL.ERR (→ p. 620) | PL.ERRFTHRESH (→ p. 621) | PL.ERRMODE (→ p. 623) | PL.ERRWTHRESH (→ p. 624)

1 Position Loop

19.21.11 PL.KI

General Information	
Type	NV Parameter
Description	Sets the integral gain of the position loop.
Units	Hz
Range	0 to 250 Hz
Default Value	0 Hz
Data Type	Float
See Also	PL.KP, PL.KD
Start Version	M_01-00-00-000

Fieldbus	Index/Subindex	Object Start Version
EtherCAT COE and CANopen	3480h/0	M_01-00-00-000

Description

PL.KI sets the integral gain of the position regulator PID loop.

Related Topics

PL.ERR (→ p. 620) | PL.ERRFTHRESH (→ p. 621) | PL.ERRMODE (→ p. 623) | PL.ERRWTHRESH (→ p. 624)

1 Position Loop

19.21.12 PL.KP

General Information	
Type	NV Parameter
Description	Sets the proportional gain of the position regulator PID loop.
Units	(rev/s)/rev
Range	0 to 2,147,483.008 (rev/s)/rev
Default Value	100 rps/rev
Data Type	Float
See Also	PL.KI (→ p. 632),
Start Version	M_01-00-00-000

Fieldbus	Index/Subindex	Object Start Version
EtherCAT COE and CANopen	3542h/0	M_01-00-00-000

Description

PL.KP sets the proportional gain of the position regulator PID loop.

Related Topics

PL.ERR (→ p. 620) | PL.ERRFTHRESH (→ p. 621) | PL.ERRMODE (→ p. 623) | PL.ERRWTHRESH (→ p. 624)

1 Position Loop

19.21.13 PL.PDELAY

General Information	
Type	R/W Parameter
Description	Sets the delay time for PL.CMD.
Units	Microseconds
Range	0, 100 to 625,000
Default Value	0
Data Type	Integer
Start Version	M_01-13-01-000

Description

PL.PDELAY inserts a delay before the position command signal. The delay is implemented after the feedforwards are calculated, which allows the feedforwards to “lead” the position command/error signals.

By tuning this filter, position loop overshoot can be reduced without affecting loop stability. This filter is considered a feedforward. For best results it should be set in conjunction with VL.FFDELAY.

After making an approximation of the Open Loop bandwidth (Hz) in the Performance Servo Tuner, calculate PL.PDELAY:

$$\text{PL.PDELAY} = 1 / (\text{Open Loop BW (Hz)} * 2\pi) * 1,000,000$$

NOTE

1,000,000 = seconds to microseconds

NOTE

PL.PDELAY and VL.FFDELAY are calculated exactly the same, however, depending on the mode of operation, sometimes an additional 250us should be added to PL.PDELAY for optimal results.

Related Topics

Using the Performance Servo Tuner (→ p. 106)

VL.FFDELAY (→ p. 716)

1 Position Loop

19.22 REC Parameters

This section describes the REC parameters.

19.22.1 REC.ACTIVE	636
19.22.2 REC.CH1 to REC.CH6	637
19.22.3 REC.DONE	638
19.22.4 REC.GAP	639
19.22.5 REC.NUMPOINTS	640
19.22.6 REC.OFF	641
19.22.7 REC.RECPRMLIST	642
19.22.8 REC.RETRIEVE	643
19.22.9 REC.RETRIEVEDATA	644
19.22.10 REC.RETRIEVEFRMT	646
19.22.11 REC.RETRIEVEHDR	647
19.22.12 REC.RETRIEVESIZE	648
19.22.13 REC.STOPTYPE	649
19.22.14 REC.TRIG	650
19.22.15 REC.TRIGPARAM	651
19.22.16 REC.TRIGPOS	652
19.22.17 REC.TRIGPRMLIST	654
19.22.18 REC.TRIGSLOPE	655
19.22.19 REC.TRIGTYPE	656
19.22.20 REC.TRIGVAL	657

19.22.1 REC.ACTIVE

General Information	
Type	R/O Parameter
Description	Indicates if data recording is in progress (active).
Units	N/A
Range	0 to 1
Default Value	N/A
Data Type	Integer
See Also	REC.DONE (→ p. 638), REC.OFF (→ p. 641)
Start Version	M_01-00-00-000

Description

REC.ACTIVE indicates whether or not data recording is in progress. Recording is in progress if the trigger was met and the recorder is recording all data.

Related Topics

Scope (→ p. 153)

19.22.2 REC.CH1 to REC.CH6

General Information	
Type	R/W Parameter
Description	Sets recording channels 1 to 6.
Units	N/A
Range	N/A
Default Value	CH1 = IL.FB CH2 = IL.CMD CH3 = VL.FB CH4 = Empty CH5 = Empty CH6 = Empty
Data Type	String
See Also	REC.TRIG (→ p. 650)
Start Version	M_01-00-00-000

Description

REC.CHx specifies the recording channels.

There are 3 options to set the recording channels values:

- Set 0, CLR, or CLEAR. This setting clears the recording channel.
- Set one of the recordable commands. The list of recordable commands can be obtain by executing REC.RECPRMLIST (→ p. 642).
- Set an internal value or variable of the drive (same as for DRV.MEMADDR (→ p. 405) input).

Related Topics

Scope (→ p. 153)

19.22.3 REC.DONE

General Information	
Type	R/O Parameter
Description	Checks whether or not the recorder has finished recording.
Units	N/A
Range	0 to 1
Default Value	N/A
Data Type	Integer
See Also	REC.ACTIVE, REC.OFF
Start Version	M_01-00-00-000

Description

REC.DONE indicates that the recorder has finished recording. This value is reset to 0 when the recorder trigger is set. The drive also resets this value when the recording has finished or when REC.OFF is executed.

Related Topics

Scope (→ p. 153)

19.22.4 REC.GAP

General Information	
Type	R/W Parameter
Description	Specifies the gap between consecutive samples.
Units	N/A
Range	1 to 65,535
Default Value	1
Data Type	Integer
See Also	REC.TRIG (→ p. 650)
Start Version	M_01-00-00-000

Description

REC.GAP specifies the gap between consecutive samples. The recording base rate is 16 kHz, thus a gap of 1 means that a sample is recorded every 62.5 μ s.

Related Topics

Scope (→ p. 153)

19.22.5 REC.NUMPOINTS

General Information	
Type	R/W Parameter
Description	Sets the number of points to record.
Units	N/A
Range	1 to 65,535
Default Value	1,000
Data Type	Integer
See Also	REC.TRIG (→ p. 650)
Start Version	M_01-00-00-000

Description

REC.NUMPOINTS specifies the number of points (samples) to record.

Related Topics

Scope (→ p. 153)

19.22.6 REC.OFF

General Information	
Type	R/W Parameter
Description	Turns the recorder OFF.
Units	N/A
Range	N/A
Default Value	N/A
Data Type	N/A
See Also	REC.ACTIVE, REC.DONE
Start Version	M_01-00-00-000

*For Profinet, write a value of 0 into the PNU to execute a command.

Description

REC.OFF turns the recorder off. In order to set the recorder again, the recorder must first be armed and then a trigger set.

Related Topics

Scope (→ p. 153)

REC.READY

19.22.7 REC.RECPRMLIST

General Information	
Type	R/O Parameter
Description	Reads the list of recordable parameters.
Units	N/A
Range	N/A
Default Value	N/A
Data Type	N/A
See Also	REC.CH1 to REC.CH6 (→ p. 637)
Start Version	M_01-00-00-000

Description

This command returns the list of recordable parameters. You can use a recordable parameter as an input to any of the recording channels.

Note that an internal address or a registered variable can be used as input to any of the channels in addition to the list.

Related Topics

Scope (→ p. 153)

19.22.8 REC.RETRIEVE

General Information	
Type	R/O Parameter
Description	Transfers all the recorded data to the communication channel.
Units	N/A
Range	N/A
Default Value	N/A
Data Type	String
See Also	N/A
Start Version	M_01-00-00-000

Description

REC.RETRIEVE causes the drive to transfer all the recorded data to the communication channel.

Example

The following format is the retrieve reply format (for N samples, G sample gap, and M parameters, where $M \leq 6$):

```
Recording
<N>, <G>
<parameter name 1> ... <parameter name M>
Value11 ... Value1M
Value N1 ... ValueNM
```

Related Topics

Scope (→ p. 153)

19.22.9 REC.RETRIEVEDATA

General Information	
Type	R/W Parameter
Description	Retrieves the recorded data without the header.
Units	N/A
Range	N/A
Default Value	N/A
Data Type	N/A
See Also	REC.RETRIEVE, REC.RETRIEVEHDR, REC.RETRIEVESIZE
Start Version	M_01-00-00-000

Description

REC.RETRIEVEDATA retrieves a section of recorded data according to REC.RETRIEVESIZE from the received index; if no index is received, the drive retrieves the data from next section. An index is supplied to enable multiple retrieves and to give better control on the buffer in case of overflow. If no index or a negative value is present, then the index is ignored.

EWV¹ uses this parameter to retrieve the data continuously for real time recoding.

The size of the data returned by this command depends on the number set by REC.RETRIEVESIZE.

Use REC.RETRIEVE for complete recording information view.

Notes:

- If REC.RETRIEVESIZE is larger than the buffer size, then it simply returns the whole buffer (no error).
- If the index is received, the data will be continuously returned starting from the given index (default starting index is 0).
- If the index is out of the bounds of the buffer, then it will be ignored.
- If recorder is active and REC.STOPTYPE==0, then this parameter returns an error.
- If REC.STOPTYPE==1, then this parameter returns the next section of data in the buffer (even if it reached the end of the buffer, it will return to the beginning of the buffer and add the data from index 0.)
- If REC.STOPTYPE==1 and the retrieve is too slow (gets overrun by the recorder), an overflow error message is returned instead of the retrieved data.
- If REC.STOPTYPE==0 and no index is received, continuously send the sections of data until the end of the buffer is reached. Then, return to the beginning of buffer and continue.
- A new REC.TRIG (→ p. 650) command automatically sets the index to 0.

Example

The following example retrieves data from index 100 in the size of 10 (hence places 100 to 109 in the buffer)

```
REC.NUMPOINTS 1000
REC.RETRIVESIZE 10
REC.TRIG
REC.RETRIEVEDATA 100
```

Related Topics

¹Embedded Workbench Views

Scope (→ p. 153)

19.22.10 REC.RETRIEVEFRMT

General Information	
Type	R/W Parameter
Description	Sets the format for recorded data output.
Units	N/A
Range	0 to 1; 0 = Standard format, 1 = Internal format (high speed)
Default Value	1
Data Type	Integer
See Also	REC.RETRIEVE (→ p. 643), REC.RETRIEVEDATA (→ p. 644)
Start Version	M_01-00-00-000

Description

Recorded data is transferred to the communication channel in one of two formats: standard or internal high speed. The standard (slower) format cannot be used for continuous recording, but is more easily read. The high speed format allows continuous data recording (needed for autotuning). EWV¹ supports both formats.

Example

The following recorder data is in standard format:

```
10,1
IL.FB,VL.CMD,VL.FB
-0.086,0.000,2.661
0.000,0.000,3.605
0.029,0.000,-0.486
```

The following recorder data is in internal format:

```
10,1
IL.FB,VL.CMD,VL.FB
F3-0x56,F30x0,F30xA65
F30x0,F30x0,F30xE15
F30x1D,F30x0,F3-0x1E6
```

Related Topics

Scope (→ p. 153)

¹Embedded Workbench Views

19.22.11 REC.RETRIEVEHDR

General Information	
Type	R/O Parameter
Description	Retrieves the recorded header without the data.
Units	N/A
Range	N/A
Default Value	N/A
Data Type	N/A
See Also	REC.RETRIEVE, REC.RETRIEVEDATA
Start Version	M_01-00-00-000

Description

This command retrieves the recorded header without the data of the recording.

EWV¹ uses this parameter to retrieve the header once before continuously reading the data for RT recoding.

Use REC.RETRIEVE for complete recording information view.

Related Topics

Scope (→ p. 153)

¹Embedded Workbench Views

19.22.12 REC.RETRIEVESIZE

General Information	
Type	R/W Parameter
Description	Sets the number of samples that REC.RETRIEVEDATA returns.
Units	recorder samples
Range	0 to 65,535 recorder samples
Default Value	1,000 recorder samples
Data Type	Integer
See Also	REC.RETRIEVEDATA (→ p. 644), REC.RETRIEVEHDR (→ p. 647)
Start Version	M_01-00-00-000

Description

This parameter sets the number of samples that REC.RETRIEVEDATA (→ p. 644) returns.

EWV¹ also uses this parameter to set the number of samples returned when retrieving the data continuously for RT recoding.

Use REC.RETRIEVE (→ p. 643) for the complete recording information view.

Related Topics

Scope (→ p. 153)

¹Embedded Workbench Views

19.22.13 REC.STOPTYPE

General Information	
Type	R/W Parameter
Description	Sets the recorder stop type.
Units	N/A
Range	0 or 1
Default Value	0
Data Type	Integer
See Also	REC.RETRIEVEDATA, REC.RETRIEVESIZE
Start Version	M_01-00-00-000

Description

This parameter sets the stop type for the recording.

0 = Recorder fills in the buffer once.

1 = Recorder runs, continuously filling the recording circular buffer.

To stop RT recording, execute REC.OFF.

Related Topics

Scope (→ p. 153)

19.22.14 REC.TRIG

General Information	
Type	Command
Description	Triggers the recorder.
Units	N/A
Range	N/A
Default Value	N/A
Data Type	N/A
See Also	REC.RETRIEVE, REC.OFF
Start Version	M_01-00-00-000

*For Profinet, write a value of 0 into the PNU to execute a command.

Description

REC.TRIG starts the trigger according to the trigger type defined by REC.TRIGTYPE.

REC.TRIG sets the value of REC.DONE to 0.

After calling REC.TRIG, the data that was recorded by previous recording is deleted and cannot be retrieved.

No REC parameters can be set after a call to REC.TRIG until the recorder has finished or until REC.OFF is executed.

Related Topics

Scope (→ p. 153)

19.22.15 REC.TRIGPARAM

General Information	
Type	R/W Parameter
Description	Sets the parameter that triggers the recorder.
Units	N/A
Range	N/A
Default Value	IL.FB
Data Type	String
See Also	REC.TRIG
Start Version	M_01-00-00-000

Description

REC.TRIGPARAM sets the parameter on which the recorder triggers.

This parameter is only used when REC.TRIGTYPE = 2.

Input values are:

1. One of the set drive parameters list that can be set as a trigger. The available parameters for trigger are: PL.ERR (→ p. 620), PL.CMD, PL.FB, VL.CMD, VL.FB, IL.CMD, and IL.FB.
2. Internal value or variable of the drive (same as for DRV.MEMADDR input).

Related Topics

Scope (→ p. 153)

19.22.16 REC.TRIGPOS

General Information	
Type	R/W Parameter
Description	Sets the trigger position in the recording buffer.
Units	%
Range	1 to 100%
Default Value	10%
Data Type	Integer
See Also	REC.TRIG (→ p. 650), REC.NUMPOINTS (→ p. 640)
Start Version	M_01-00-00-000

Description

REC.TRIGPOS sets the trigger position in the recording buffer. The recording buffer size is defined by REC.NUMPOINTS. The input value is a percentage of the buffer (that is, a value of 25 means saving 25% of the buffer data before the trigger occurs and 75% after it occurs). This parameter is only used when REC.TRIGTYPE = 2 or 3.

Trigger Position

Trigger position (REC.TRIGPOS) allows you to collect data that occurs before the trigger occurs. In some instances, you may want to see the conditions prior to the trigger. Trigger position lets you control how much signal is collected before the trigger condition occurred.

Trigger position is specified in units of percent (%). If you specify a trigger position of $x\%$, then $x\%$ of the data is before 0 ms in the data time and $100-x\%$ (the rest of the data) is at or greater than 0 ms. In the figure below, the trigger position is set to 25% (REC.TRIGPOS 25).

In the EWV¹ scope, the 0 time point is clear. When collecting the data using REC.RETRIEVE or similar commands, the time is not returned, so some caution should be used when the trigger point is important to understand.

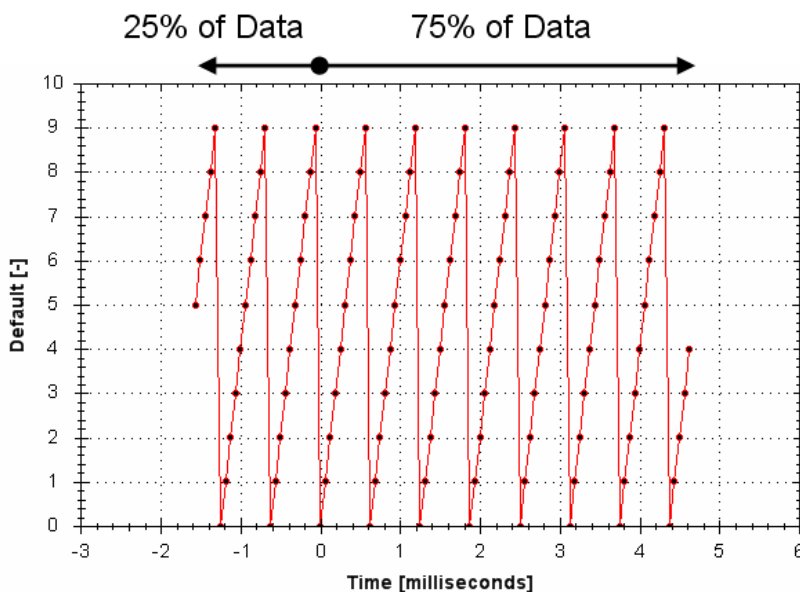

¹Embedded Workbench Views

Related Topics

Scope (→ p. 153)

19.22.17 REC.TRIGPRMLIST

General Information	
Type	R/O Parameter
Description	Reads the list of possible trigger parameters.
Units	N/A
Range	N/A
Default Value	N/A
Data Type	N/A
See Also	REC.TRIGPARAM
Start Version	M_01-00-00-000

Description

This command returns the list of trigger parameters. Each one of those parameters can serve as the trigger parameter (input to REC.TRIGPARAM).

Note that an internal address or a registered variable can be used as input to REC.TRIGPARAM in addition to the list that this parameter returns.

Related Topics

Scope (→ p. 153)

19.22.18 REC.TRIGSLOPE

General Information	
Type	R/W Parameter
Description	Sets the trigger slope.
Units	0 = Negative 1 = Positive
Range	0 to 1
Default Value	0
Data Type	Integer
See Also	REC.TRIG, REC.NUMPOINTS
Start Version	M_01-00-00-000

Description

REC.TRIGSLOPE sets the recorder trigger slope. This parameter is only used when REC.TRIGTYPE = 2 or 3.

Related Topics

Scope (→ p. 153)

19.22.19 REC.TRIGTYPE

General Information	
Type	R/W Parameter
Description	Sets the trigger type.
Units	0 = immediate 1 = command 2 = parameter 3 = boolean
Range	0 to 2
Default Value	0
Data Type	Integer
See Also	REC.TRIG (→ p. 650), REC.TRIGPARAM, REC.TRIGVAL, REC.TRIGSLOPE REC.TRIGPOS
Start Version	M_01-00-00-000

Description

REC.TRIGTYPE sets the type of trigger.

Input values are as follows:

Value	Description
0	Recording starts immediately
1	Recording starts on the next command executed through the TCP/IP. The trigger location in the buffer is set according to REC.TRIGPOS.
2	Recording starts per the values of REC.TRIGPARAM, REC.TRIGVAL, REC.TRIGSLOPE, and REC.TRIGPOS.
3	Recording starts when the value of REC.TRIGPARAM is 0 for REC.TRIGSLOPE = 0 or 1 for REC.TRIGSLOPE = 1

Related Topics

Scope (→ p. 153)

19.22.20 REC.TRIGVAL

General Information	
Type	R/W Parameter
Description	Sets the trigger value.
Units	The units of the parameter are chosen according to the unit type.
Range	0 to 2
Default Value	0
Data Type	Integer
See Also	REC.TRIG (→ p. 650), REC.TRIGPARAM, REC.TRIGVAL, REC.TRIGSLOPE, REC.TRIGPOS
Start Version	M_01-00-00-000

Description

REC.TRIGVAL is the value that must be met by REC.TRIGPARAM for the trigger to occur. The units of this parameter are set according to the units of REC.TRIGPARAM.

Related Topics

Scope (→ p. 153)

19.23 REGEN Parameters

This section describes the REGEN parameters.

19.23.1 REGEN.POWER	659
19.23.2 REGEN.POWERFILTERED	660
19.23.3 REGEN.REXT	661
19.23.4 REGEN.TEXT	662
19.23.5 REGEN.TYPE	663
19.23.6 REGEN.WATTEXT	664

19.23.1 REGEN.POWER

General Information	
Type	R/O parameter
Description	Reads regen resistor's calculated power.
Units	Watt
Range	N/A
Default Value	N/A
Data Type	Integer
See Also	N/A
Start Version	M_01-00-00-000

Fieldbus	Index/Subindex	Object Start Version
EtherCAT COE and CANopen	3416h/0	M_01-00-00-000

Description

This parameter reads regen resistor's calculated power, which is determined as follows:

$$(V^2 / R) * DutyCycle$$

Related Topics

6.4 Regeneration

19.23.2 REGEN.POWERFILTERED

General Information	
Type	R/O parameter
Description	Returns a filtered version of REGEN.POWER .
Units	Watt
Range	0 to REGEN.WATTEXT
Default Value	0
Data Type	Integer
Start Version	M_01-07-01-000

Fieldbus	Index/Subindex	Object Start Version
EtherCAT COE and CANopen	3417h/0	M_01-00-00-000

Description

This parameter returns a filtered value of REGEN.POWER. A single order lowpass of $1/\text{REGEN.TEXT}$ Hz is applied to generate REGEN.POWERFILTERED.

If REGEN.POWERFILTERED exceeds the value of REGEN.WATTEXT, Fault 521 (Regen overpower) will be generated.

This keyword may be recorded in the scope screen for analysis.

Example

$\text{REGEN.TEXT} = 10$ (seconds)

Lowpass Filter Frequency = $1/10$ seconds = 0.1 Hz

$\text{REGEN.POWERFILTERED} = \text{REGEN.POWER} * 0.1\text{Hz lowpass}$

Related Topics

REGEN.POWER (→ p. 659) | REGEN.TEXT (→ p. 662) | REGEN.WATTEXT (→ p. 664)

19.23.3 REGEN.REXT

General Information	
Type	NV Parameter
Description	Sets the external, user-defined regen resistor resistance.
Units	Ω
Range	0 to 255 Ω
Default Value	0 Ω
Data Type	Integer
See Also	N/A
Start Version	M_01-00-00-000

Fieldbus	Index/Subindex	Object Start Version
EtherCAT COE and CANopen	35C2h/0	M_01-00-00-000

Description

REGEN.REXT sets the external user-defined regen resistor resistance. This variable is needed for the regen resistor temperature estimation algorithm.

Related Topics

6.4 Regeneration

19.23.4 REGEN.TEXT

General Information	
Type	R/W Parameter
Description	Sets the external regen resistor thermal protection time constant.
Units	Seconds
Range	0.1 to 1,200 Seconds
Default Value	100 Seconds
Data Type	Float
See Also	REGEN.WATTEXT (→ p. 664), REGEN.REXT (→ p. 661)
Start Version	M_01-00-00-000

Fieldbus	Index/Subindex	Object Start Version
EtherCAT COE and CANopen	3415h/0	M_01-00-00-000

Description

REGEN.TEXT is the time-to-fault when input power steps from 0 to 150% of REGEN.WATTEXT. REGEN.TEXT sets the thermal time constant of the algorithm used to protect the regeneration resistor from overheating and failing. The drive's regen resistor protection algorithm continuously calculates the power dissipated in the resistor and processes that power value through a single pole low pass filter to model the regen resistor's thermal inertia. When the filtered regen power on the output of the filter (REGEN.POWERFILTERED) exceeds REGEN.WATTEXT, a fault occurs. REGEN.TEXT sets the time constant of this thermal inertial filter = (REGEN.TEXT/1.1).

REGEN.TEXT can often be found directly on power resistor data sheets. On the data sheet find the peak overload curve and then find the safe allowed time to be at 150% of the regen resistor's continuous power rating. Set REGEN.TEXT to this value in seconds. Another way regen resistor peak overload capability is often specified is by giving the energy rating in joules of the resistor. If you have the energy rating joule limit E then:

$$\text{REGEN.TEXT} = (1.1) * ((E \text{ in joules}) / \text{REGEN.WATTEXT})$$

Example

The external regen resistor is rated for 250 W continuous, is 33 ohm, and has a joule rating of 500 joules. To use this resistor, the drive settings become:

REGEN.TYPE = -1 (External Regen)

REGEN.REXT = 33

REGEN.WATTEXT = 250

REGEN.TEXT = (1.1)*(500 j)/(250 W) = 2.2 sec

Related Topics

6.4 Regeneration

19.23.5 REGEN.TYPE

General Information	
Type	NV Parameter
Description	Sets the regen resistor type.
Units	N/A
Range	-1 to 0
Default Value	0
Data Type	Integer
See Also	N/A
Start Version	M_01-00-00-000

Fieldbus	Index/Subindex	Object Start Version
EtherCAT COE and CANopen	3412h/0	M_01-00-00-000

Description

You can specify a user-defined external regen resistor, select an internal regen resistor, or choose from a list of predefined regen resistors. The values for REGEN.TYPE are shown below:

Type	Description
-1	External user-defined regen resistor
0	Internal regen resistor

If you specify a user-defined regen resistor, then you must also define this resistor's resistance (REGEN.REXT), heatup time (REGEN.REXT), and power (REGEN.WATTEXT).

Related Topics

6.4 Regeneration

19.23.6 REGEN.WATTEXT

General Information	
Type	R/W parameter
Description	Sets the regen resistor's power fault level for an external regen resistor.
Units	W
Range	0 to 62,000 W
Default Value	1000 W
Data Type	Integer
See Also	N/A
Start Version	M_01-00-00-000

Fieldbus	Index/Subindex	Object Start Version
EtherCAT COE and CANopen	3414h/0	M_01-00-00-000

Description

Sets the regen resistor's power fault level for an external regen resistor (when REGEN.TYPE = -1). Above this fault level, the regen resistor's PWM will be 0 and a fault will be issued.

Related Topics

6.4 Regeneration

19.24 SM Parameters

This section describes the SM parameters.

19.24.1 SM.ACC	666
19.24.2 SM.DEC	667
19.24.3 SM.I1	668
19.24.4 SM.I2	669
19.24.5 SM.MODE	670
19.24.6 SM.MOVE	673
19.24.7 SM.T1	674
19.24.8 SM.T2	675
19.24.9 SM.V1	676
19.24.10 SM.V2	677

19.24.1 SM.ACC

General Information	
Type	NV Parameter
Description	Sets the acceleration ramp for service motion if set to greater than 0.
Units	Depends on UNIT.ACCROTARY or UNIT.ACCLINEAR Rotary: rps/s, rpm/s, deg/s ² , (custom units)/s ² , rad/s ² Linear: counts/s ² , mm/s ² , μm/s ² , (custom units)/s ²
Range	Note: The range and default values of (custom units)/s ² units depend on the values of PIN and POUT. The range and default values listed in this table are derived from the default values of PIN and POUT. Rotary: 0.0 to 833,333.333 rps/s 0.0 to 50,000,000.000 rpm/s 0.0 to 300,000,000.000 deg/s ² 0.0 to 4,166,666.752 (custom units)/s ² 0.0 to 5,235,987.968 rad/s ² Linear: 0 to 3,579,139,408,000.000 counts/s ² 0 to 833,333.333*MOTOR.PITCH mm/s ² 0 to 2,147,483.647*MOTOR.PITCH μm/s ² 0 to 2,147,483.647 (custom units)/s ²
Default Value	0
Data Type	Float
Start Version	M_01-13-06-000

Description

Sets the acceleration ramp for service motion if set to greater than 0.

Related Topics

Service Motion (→ p. 91)

19.24.2 SM.DEC

General Information	
Type	NV Parameter
Description	Sets the deceleration ramp for service motion if set to greater than 0.
Units	Depends on UNIT.ACCROTARY or UNIT.ACCLINEAR Rotary: rps/s, rpm/s, deg/s ² , (custom units)/s ² , rad/s ² Linear: counts/s ² , mm/s ² , μm/s ² , (custom units)/s ²
Range	Note: The range and default values of (custom units)/s ² units depend on the values of PIN and POUT. The range and default values listed in this table are derived from the default values of PIN and POUT. Rotary: 0.0 to 833,333.333 rps/s 0.0 to 50,000,000.000 rpm/s 0.0 to 300,000,000.000 deg/s ² 0.0 to 4,166,666.752 (custom units)/s ² 0.0 to 5,235,987.968 rad/s ² Linear: 0 to 3,579,139,408,000.000 counts/s ² 0 to 833,333.333*MOTOR.PITCH mm/s ² 0 to 833,333,333.333*MOTOR.PITCH μm/s ² 0 to 4,166,666.667 (custom units)/s ²
Default Value	0
Data Type	Float
Start Version	M_01-13-06-000

Description

Sets the deceleration ramp for service motion if set to greater than 0.

Related Topics

Service Motion (→ p. 91)

19.24.3 SM.I1

General Information	
Type	NV Parameter
Description	Sets service motion current 1; active in opmode 0 (torque) only.
Units	A
Range	–Drive peak current to +Drive peak current
Default Value	0.025 · Drive peak current
Data Type	Float
See Also	SM.ACCTYPE, SM.I2, SM.MODE, SM.MOVE, SM.T1, SM.T2, SM.V1, SM.V2, SM.VPM1, SM.VPM2
Start Version	M_01-00-00-000

Description

SM.I1 defines the current that is used in service motion modes 0 and 1 (see SM.MODE (→ p. 670)).

Related Topics

Service Motion (→ p. 91)

19.24.4 SM.I2

General Information	
Type	NV Parameter
Description	Sets service motion current 2; active in opmode 0 (torque) only.
Units	A
Range	–Drive peak current to +Drive peak current
Default Value	0.025 · Drive peak current
Data Type	Float
See Also	SM.ACCTYPE, SM.I1, SM.MODE, SM.MOVE, SM.T1, SM.T2, SM.V1, SM.V2, SM.VPM1, SM.VPM2
Start Version	M_01-00-00-000

Description

SM.I2 defines the current that is used in service motion mode 1 (see SM.MODE (→ p. 670)).

Related Topics

Service Motion (→ p. 91)

19.24.5 SM.MODE

General Information	
Type	NV Parameter
Description	Sets the service motion mode.
Units	N/A
Range	0 to 2
Default Value	0
Data Type	Integer
See Also	SM.I1 (→ p. 668), SM.I2 (→ p. 669), SM.MOVE (→ p. 673), SM.T1 (→ p. 674) SM.T2 (→ p. 675), SM.V1 (→ p. 676), SM.V2 (→ p. 677), DRV.ACC (→ p. 354) DRV.DEC (→ p. 366)
Start Version	M_01-01-00-000

Fieldbus	Index/Subindex	Object Start Version
EtherCAT COE and CANopen	5177h/0	M_01-01-00-000

Description

SM.MODE defines the mode of service motion for each loop. Two types of service motion are available :

- A constant motion in one direction (endless or for a certain amount of time).
- An alternating motion.

The possible modes for this parameter are described in the following table:

SM.MODE	Description	Requirements
0	<p>Constant motion in closed current loop mode of operation.</p> <ul style="list-style-type: none"> • DRV.OPMODE 0: The drive generates a constant current command value (SM.I1) for a certain amount of time (if SM.T1>0) or endless (if SM.T1=0). The drive will not generate any ramps in this mode of operation. • DRV.OPMODE 1 or 2: The drive generates a constant velocity command value (SM.V1) for a certain amount of time (if SM.T1>0) or endless (if SM.T1=0). The drive generates acceleration and deceleration ramps according to the DRV.ACC and DRV.DEC setting in this mode of operation. <p>The service motion can be stopped by using the DRV.STOP command.</p>	<p>DRV.OPMODE = 0, 1, or 2 DRV.CMDSOURCE = 0</p>

SM.MODE	Description	Requirements
1	<ul style="list-style-type: none"> • DRV.OPMODE 0: The drive generates a current command value (SM.I1) for a certain amount of time (SM.T1). Afterwards the drive generates a current command value (SM.I2) for another certain amount of time (SM.T2). This sequence is repeated as long as a DRV.STOP command occurs. The drive will not generate any ramps in this mode of operation. • DRV.OPMODE 1 or 2: The drive generates a velocity command value (SM.V1) for a certain amount of time (SM.T1). Afterwards the drive generates a velocity command value (SM.V2) for another certain amount of time (SM.T2). This sequence is repeated as long as a DRV.STOP command occurs. The drive will generate an acceleration and deceleration ramps according to the DRV.ACC and DRV.DEC setting in this mode of operation. 	DRV.OPMODE = 0, 1, or 2 DRV.CMDSOURCE = 0
2	This mode executes the same service motion as mode 0. However, the motion is described by SM.I2, SM.T2 and SM.V2. This enables a change on the fly and is mostly used under fieldbus control.	DRV.OPMODE = 0, 1, or 2 DRV.CMDSOURCE = 0

Ramps

The drive uses DRV.ACC and DRV.DEC for the ramps in DRV.OPMODE 1 (closed velocity) and 2 (closed position). The drive does not generate any ramps in service motion mode 0 and 1.

Service Motion for DRV.OPMODE 0 and SM.MODE 1

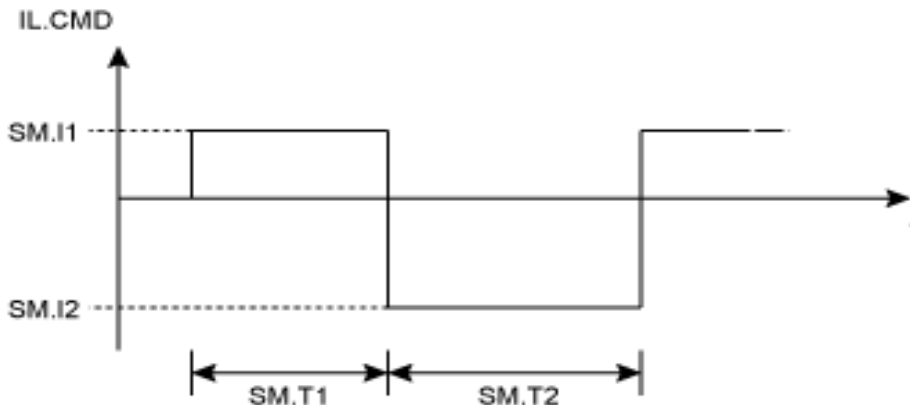

Service motion for DRV.OPMODE 1 or 2 and SM.MODE 1

DRV.OPMODE 1: VL.CMD
DRV.OPMODE 2: d/dt (PL.CMD)

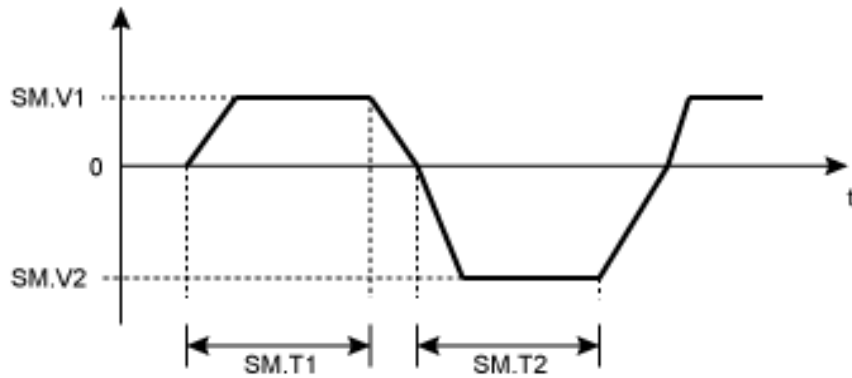

The deceleration process from SM.V1 or SM.V2 to 0 is not included in SM.T1 and SM.T2, respectively. SM.T1 and SM.T2 start as soon as the command value has reached the velocity 0.

Related Topics

Service Motion (→ p. 91)

19.24.6 SM.MOVE

General Information	
Type	Command
Description	Starts the service motion.
Units	N/A
Range	N/A
Default Value	N/A
Data Type	N/A
See Also	SM.MODE
Start Version	M_01-00-00-000

*For Profinet, write a value of 0 into the PNU to execute a command.

Description

This command starts the service motion that has been selected by the SM.MODE parameter.

Related Topics

Service Motion (→ p. 91)

19.24.7 SM.T1

General Information	
Type	NV Parameter
Description	Sets the service motion time 1.
Units	ms
Range	0 to 65,535 ms
Default Value	500 ms
Data Type	Integer
See Also	SM.I1, SM.I2, SM.MODE, SM.MOVE, SM.T2, SM.V1, SM.V2, SM.VPM1, SM.VPM2
Start Version	M_01-00-00-000

Fieldbus	Index/Subindex	Object Start Version
EtherCAT COE and CANopen	5179h/0	M_01-00-00-000

Description

SM.T1 defines the time of the service motion that is used in all service motion modes (see SM.MODE). For an alternating service motion mode, SM.T1 may not be set to 0.

Related Topics

Service Motion (→ p. 91)

19.24.8 SM.T2

General Information	
Type	NV Parameter
Description	Sets the service motion time 2.
Units	ms
Range	0 to 65,535 ms
Default Value	500 ms
Data Type	Integer
See Also	SM.I1, SM.I2, SM.MODE, SM.MOVE, SM.T1, SM.V1, SM.V2, SM.VPM1, SM.VPM2
Start Version	M_01-00-00-000

Fieldbus	Index/Subindex	Object Start Version
EtherCAT COE and CANopen	517Ah/0	M_01-00-00-000

Description

SM.T2 defines the time of the service motion that is used in service motion modes 1, 3, and 5 (see SM.MODE).

Related Topics

Service Motion (→ p. 91)

19.24.9 SM.V1

General Information	
Type	NV Parameter
Description	Sets service motion velocity 1; active in opmode 1 (velocity) and 2 (position).
Units	Depends on UNIT.ACCROTARY (pg 1) or UNIT.ACCLINEAR Rotary: rpm, rps, deg/s, custom units/s, rad/s Linear: Counts/s, mm/s, μ m/s, custom units/s
Range	Rotary: -15,000.000 to 15,000.000 rpm -250.000 to 250.000 rps -90,000.000 to 90,000.000 deg/s -1,250.000 to 1,250.000 custom units/s -1,570.796 to 1,570.796 rad/s Linear: -1,073,741,824,000.000 to 1,073,741,824,000.000 counts/s -250.000*MOTOR.PITCH (\rightarrow p. 599) to 250.000*MOTOR.PITCH (\rightarrow p. 599) mm/s -250,000.000*MOTOR.PITCH (\rightarrow p. 599) to 250,000.000*MOTOR.PITCH (\rightarrow p. 599) μ m/s -1,250.000 to 1,250.000 custom units/s
Default Value	Rotary: 60.000 rpm 1.000 rps 359.999 deg/s 5.000 custom units/s 6.283 rad/s Linear: 0.001 Counts/s 1.000*MOTOR.PITCH (\rightarrow p. 599) mm/s 999.998*MOTOR.PITCH (\rightarrow p. 599) μ m/sec 5.000 custom units/s
Data Type	Float
See Also	SM.I1, SM.I2, SM.MODE, SM.MOVE, SM.T1, SM.T2, SM.V2
Start Version	M_01-00-00-000

Description

SM.V1 defines the velocity that is used in service motion modes 0 and 1 (see SM.MODE (\rightarrow p. 670)) in the closed velocity and position mode of operation.

Related Topics

11.1 Service Motion

19.24.10 SM.V2

General Information	
Type	NV Parameter
Description	Sets service motion velocity 2; active in opmode 1 (velocity) and 2 (position).
Units	Depends on UNIT.ACCROTARY (pg 1) or UNIT.ACCLINEAR Rotary: rpm, rps, deg/s, custom units/s, rad/s Linear: counts/s, mm/s, $\mu\text{m/s}$, custom units/s
Range	Rotary: -15,000.000 to 15,000.000 rpm -250.000 to 250.000 rps -90,000.000 to 90,000.000 deg/s -1,250.000 to 1,250.000 custom units/s -1,570.796 to 1,570.796 rad/s Linear: -1,073,741,824,000.000 to 1,073,741,824,000.000 counts/s -250.000*MOTOR.PITCH (\rightarrow p. 599) to 250.000*MOTOR.PITCH (\rightarrow p. 599) mm/s -250,000.000*MOTOR.PITCH (\rightarrow p. 599) to 250,000.000*MOTOR.PITCH (\rightarrow p. 599) $\mu\text{m/s}$ -1,250.000 to 1,250.000 custom units/s
Default Value	Rotary: -60.000 rpm -1.000 rps -359.999 deg/s -5.000 custom units/s -6.283 rad/s Linear: -0.001 counts/s -1.000*MOTOR.PITCH (\rightarrow p. 599) mm/s -999.998*MOTOR.PITCH (\rightarrow p. 599) $\mu\text{m/sec}$ -5.000 custom units/s
Data Type	Float
See Also	SM.I1, SM.I2, SM.MODE, SM.MOVE, SM.T1, SM.T2, SM.V1
Start Version	M_01-00-00-000

Description

SM.V2 defines the velocity that is used in service motion mode 1 (see SM.MODE) in the closed velocity and position mode of operation.

Related Topics

11.1 Service Motion

19.25 STO Parameters

This section describes the STO parameters.

19.25.1 STO.STATE	679
--------------------------------	------------

19.25.1 STO.STATE

General Information	
Type	R/O Parameter
Description	Returns the status of the safe torque off.
Units	N/A
Range	0 to 1 for drives with only one STO (AKD-M003 up to AKD-M024) 0 to 3 for drives that support STO2 (AKD-M048)
Default Value	N/A
Data Type	Integer
See Also	N/A
Start Version	M_01-00-00-000

Description

STO.STATE returns the status of the safe torque off.

AKD-M003 up to AKD-M024 (one STO channel)

Value	Description
1	Safe torque on (no STO fault/warning)
0	Safe torque off (STO fault and warning are present)

1 - Safe torque on (no safe torque off fault/warning).

0 - Safe torque off (safe torque off fault/warning).

When STO.STATE = 1, the drive can be enabled.

AKD-M048 (two STO channels)

An STO fault and warning are generated when either STO1 or STO2 are not on. Use STO.STATE to determine the source (STO1 or STO2) of the STO fault. EWV¹ also displays the status of both STO1 and STO2 at the bottom of the screen.

Value	Description
3	STO1 and STO2 are on (no STO fault/warning)
2	STO1 is off, and STO2 is on (STO fault and warning are present)
1	STO1 is on, and STO2 is off (STO fault and warning are present)
0	STO1 and STO2 are off (STO fault and warning are present)

Related Topics

Safe Torque Off (STO) (→ p. 1)

10.1 Limits

¹Embedded Workbench Views

19.26 SWLS Parameters

This section describes the SWLS parameters.

19.26.1 SWLS.EN	681
19.26.2 SWLS.LIMIT0	682
19.26.3 SWLS.LIMIT1	683
19.26.4 SWLS.STATE	684

19.26.1 SWLS.EN

General Information	
Type	NV Parameter
Description	Enables and disables software travel limit switches.
Units	N/A
Range	0 to 3
Default Value	0
Data Type	U8
See Also	DRV.MOTIONSTAT
Start Version	M_01-00-00-000

Fieldbus	Index/Subindex	Object Start Version
EtherCAT COE and CANopen	517Eh/0	M_01-00-00-000

Description

This parameter enables the software travel limit switches. The software limit switches are only active if the axis is homed.

Value	Description
0	Disables both limit switches.
1	Enables limit switch 0.
2	Enables limit switch 1.
3	Enables limit switch 0 and limit switch 1.

If SWLS.EN = 3, then whichever limit switch is set to a greater value will be used as the upper limit switch. For all other values of SWLS.EN, use SWLS.LIMIT0 for the lower limit switch, and SWLS.LIMIT1 for the upper limit switch.

Example

Bit 0 = 0: Disable SWLS.LIMIT0

Bit 0 = 1: Enable SWLS.LIMIT0

Bit 1 = 0: Disable SWLS.LIMIT1

Bit 1 = 1: Enable SWLS.LIMIT1

Related Topics

10.1 Limits

19.26.2 SWLS.LIMIT0

General Information	
Type	NV Parameter
Description	Sets the position of the software travel limit switch 0.
Units	Position units
Range	-9,007,199,254,740,992 to 9,007,199,254,740,991
Default Value	0
Data Type	S64
Start Version	M_01-00-00-000

Fieldbus	Index/Subindex	Object Start Version
EtherCAT COE and CANopen	607Dh/1	M_01-00-00-000

Description

This parameter sets the compare register for the software limit switch 0. This value can be either the lower or the upper software limit switch register, depending on the configuration of the software limit switches:

- If only one limit switch is enabled (SWLS.EN = 1 or 2), then SWLS.LIMIT0 is the lower limit, and SWLS.LIMIT1 is the upper limit.
- If both limit switches are enabled (SWLS.EN = 3), then whichever switch is set to a larger value is the upper limit switch. The other switch becomes the lower limit switch.

These switches can be used in addition to hardware limit switches. The software limit switches are only active if the axis is homed. For more information about homing, please refer to the HOME Parameters and DRV.MOTIONSTAT.

Related Topics

10.1 Limits

19.26.3 SWLS.LIMIT1

General Information	
Type	NV Parameter
Description	Sets the position of the software travel limit switch 0.
Units	Position units
Range	-9,007,199,254,740,992 to 9,007,199,254,740,991
Default Value	1,048,576.000 counts, 16-bit (firmware versions M_01-02-00-000 and above) 68,719,476,736 counts (for firmware version M_01-01-00-000)
Data Type	S64
Start Version	M_01-00-00-000

Fieldbus	Index/Subindex	Object Start Version
EtherCAT COE and CANopen	607Dh/2	M_01-00-00-000

Description

This parameter sets the compare register for the software limit switch 1. This value can be either the lower or the upper software limit switch register, depending on the configuration of the software limit switches:

- If only one limit switch is enabled (SWLS.EN = 1 or 2), then SWLS.LIMIT0 is the lower limit, and SWLS.LIMIT1 is the upper limit.
- If both limit switches are enabled (SWLS.EN = 3), then whichever switch is set to a larger value is the upper limit switch. The other switch becomes the lower limit switch.

These switches can be used in addition to hardware limit switches. The software limit switches are only active if the axis is homed. For more information about homing, please refer to the HOME Parameters and DRV.MOTIONSTAT.

Related Topics

10.1 Limits

19.26.4 SWLS.STATE

General Information	
Type	R/O Parameter
Description	Reads the actual status of software limit switches.
Units	N/A
Range	0 to 3
Default Value	0
Data Type	U8
Start Version	M_01-00-00-000

Description

This parameter reads the status word of the software limit switches. The status word indicates the result of the compare between the software limit switch compare register and the actual position of the position loop.

Example

Bit 0 = 0: SWLS.LIMIT0 (→ p. 682) is not active.

Bit 0 = 1: SWLS.LIMIT0 is active.

Bit 1 = 0: SWLS.LIMIT1 (→ p. 683) is not active.

Bit 1 = 1: SWLS.LIMIT1 is active.

Bits 2 to 7 are currently not in use.

Related Topics

10.1 Limits

19.27 TEMP Parameters

This section describes the TEMP parameters.

19.27.1 TEMP.CONTROL	686
19.27.2 TEMP.POWER1 to TEMP.POWER3	687

19.27.1 TEMP.CONTROL

General Information	
Type	R/O Parameter
Description	Reads the temperature of the control board temperature sensor.
Units	Degrees Celsius
Range	-127 to 128
Default Value	N/A
Data Type	Integer
Start Version	M_01-09-00-000

Description

Reads the temperature of the control board temperature sensor.

Related Topics

DRV.TEMPERATURES (→ p. 423) | TEMP.POWER1 to TEMP.POWER3 (→ p. 687)

19.27.2 TEMP.POWER1 to TEMP.POWER3

General Information	
Type	R/O Parameter
Description	Reads the temperature of the power board(s) temperature sensor (s).
Units	Degrees Celsius
Range	-127 to 128
Default Value	N/A
Data Type	Integer
Start Version	M_01-09-00-000

Description

Reads the temperature of the power board(s) temperature sensor(s). Most AKD PDMMs have only one power board sensor which is read by TEMP.POWER1.

Related Topics

DRV.TEMPERATURES (→ p. 423) | TEMP.CONTROL (→ p. 686)

19.28 USER Parameters

This section describes the USER parameters.

19.28.1 USER.INT1 to USER.INT24	689
--	------------

19.28.1 USER.INT1 to USER.INT24

General Information	
Type	R/W Parameter
Description	Stores an integer value for future reference.
Units	N/A
Range	-2,147,483,648 to 2,147,483,647
Default Value	0
Data Type	Integer
Start Version	M_01-00-00-000

Description

This parameter stores an integer value. To retain this value after a power-cycle, a "Save to Device" command must be performed from the Parameter Load/Save view in [EWV¹](#).

¹Embedded Workbench Views

19.29 VBUS Parameters

This section describes the VBUS parameters.

19.29.1 VBUS.HALFVOLT	691
19.29.2 VBUS.OVFTHRESH	692
19.29.3 VBUS.OVWTHRESH	693
19.29.4 VBUS.RMSLIMIT	694
19.29.5 VBUS.UVFTHRESH	695
19.29.6 VBUS.UVMODE	696
19.29.7 VBUS.UVWTHRESH	697
19.29.8 VBUS.VALUE	698

19.29.1 VBUS.HALFVOLT

General Information	
Type	NV Parameter
Description	Changes voltage thresholds for -07 drives.
Units	N/A
Range	0 to 1
Default Value	0
Data Type	Integer
See Also	N/A
Start Version	M_01-04-01-000

Fieldbus	Index/Subindex	Object Start Version
EtherCAT COE and CANopen	5261h/0	M_01-04-01-000

Description

This parameter is used to change voltage thresholds to allow -07 drive types to work at an -06 drive type's voltage thresholds. For information on voltage ratings and drive types see AKD PDMM Models (→ p. 27).

When the VBUS.HALFVOLT value is changed, the revised thresholds take effect immediately.

VBUS.HALFVOLT only affects -07 drives.

Value	Description
0	The original voltage thresholds are used for the functions mentioned below.
1	-07 drives use voltage thresholds of -06 drives.

This parameter has an impact on the following voltage-thresholds:

1. DC-bus over-voltage threshold (see VBUS.OVFTHRESH (→ p. 692)).
2. The regen-resistor enable/disable voltage thresholds.
3. The inrush-relay enable/disable voltage thresholds.

NOTE

The DC-bus under voltage fault threshold (see VBUS.UVFTHRESH (→ p. 695)) is a user selectable command. It means that the user is responsible for setting the under voltage threshold to a proper value in case that the AKD PDMM is supplied with a lower DC-bus voltage than the rated voltage.

19.29.2 VBUS.OVFTHRESH

General Information	
Type	R/O Parameter
Description	Reads the over voltage fault level.
Units	VDC
Range	0 to 900 VDC
Default Value	N/A
Data Type	Integer
See Also	VBUS.UVFTHRESH
Start Version	M_01-00-00-000

Description

VBUS.OVFTHRESH reads the over voltage fault level for the DC bus.

This value is read from the drive EEPROM and varies according to the drive type.

Related Topics

Regeneration (→ p. 44)

19.29.3 VBUS.OVWTHRESH

General Information	
Type	NV Parameter
Description	Sets voltage level for over voltage warning.
Units	VDC
Range	0 to 900 VDC
Default Value	0 VDC (warning disabled)
Data Type	U16
See Also	N/A
Start Version	M_01-00-00-000

Fieldbus	Index/Subindex	Object Start Version
EtherCAT COE and CANopen	518Eh/0	M_01-00-00-000

Description

If VBUS.VALUE value exceeds VBUS.OVWTHRESH, then a warning is generated. The warning is removed if the voltage returns to below 97% (1/32) of the overvoltage warning level.

Related Topics

Regeneration (→ p. 44)

19.29.4 VBUS.RMSLIMIT

General Information	
Type	R/O Parameter
Description	Reads the limit for the bus capacitors load.
Units	Vrms
Range	N/A
Default Value	N/A
Data Type	Integer
See Also	N/A
Start Version	M_01-00-00-000

Description

This parameter reads the limit of the bus capacitor load. When the bus capacitor loads exceeds this limit, the drive generates fault F503.

Excessive bus capacitor load may indicate a disconnected main supply phase.

Related Topics

Regeneration (→ p. 44)

19.29.5 VBUS.UVFTHRESH

General Information	
Type	R/W Parameter
Description	Sets the under voltage fault level.
Units	VDC
Range	90 to 420 VDC
Default Value	90 VDC
Data Type	Integer
See Also	VBUS.OVFTHRESH
Start Version	M_01-00-00-000

Fieldbus	Index/Subindex	Object Start Version
EtherCAT COE and CANopen	361Dh/0	M_01-00-00-000

Description

VBUS.UVFTHRESH sets the undervoltage fault level of the DC bus.

The default value is read from the EEPROM, but can be modified by the user and stored on the NV RAM. This value varies according to drive type.

Related Topics

Regeneration (→ p. 44)

19.29.6 VBUS.UVMODE

General Information	
Type	N/V Parameter
Description	Indicates undervoltage (UV) mode.
Units	N/A
Range	0 to 1
Default Value	1
Data Type	Integer
See Also	N/A
Start Version	M_01-00-00-000

Fieldbus	Index/Subindex	Object Start Version
EtherCAT COE and CANopen	3617h/0	M_01-00-00-000

Description

This parameter indicates undervoltage (UV) mode.

When VBUS.UVMODE = 0, an undervoltage fault is issued whenever the DC bus goes below the undervoltage threshold.

When VBUS.UVMODE = 1, an undervoltage fault is issued whenever the DC bus goes below the undervoltage threshold and the controller attempts to enable the drive (software or hardware enable).

Related Topics

Regeneration (→ p. 44)

19.29.7 VBUS.UVWTHRESH

General Information	
Type	NV Parameter
Description	Sets voltage level for undervoltage warning.
Units	VDC
Range	0 to 900 VDC
Default Value	10 volts above the default value of the under voltage fault threshold (VBUS.UVFTHRESH). The default value of VBUS.UVFTHRESH is hardware dependent.
Data Type	U16
See Also	VBUS.UVFTHRESH (→ p. 695)
Start Version	M_01-00-00-000

Fieldbus	Index/Subindex	Object Start Version
EtherCAT COE and CANopen	3495h/0	M_01-00-00-000

Description

If VBUS.VALUE value drops below VBUS.UVWTHRESH, then a warning is generated.

Related Topics

Regeneration (→ p. 44)

19.29.8 VBUS.VALUE

General Information	
Type	R/O Parameter
Description	Reads DC bus voltage.
Units	VDC
Range	0 to 900 VDC
Default Value	N/A
Data Type	Float
See Also	N/A
Start Version	M_01-00-00-000

Fieldbus	Index/Subindex	Object Start Version
EtherCAT COE and CANopen	361Ah/0	M_01-00-00-000

Description

VBUS.VALUE reads the DC bus voltage.

Related Topics

6.4 Regeneration

19.30 VL Parameters

This section describes the VL parameters.

19.30.1 VL.ARPF1 TO VL.ARPF4	700
19.30.2 VL.ARPQ1 TO VL.ARPQ4	702
19.30.3 VL.ARTYPE1 TO VL.ARTYPE4	704
19.30.4 VL.ARZF1 TO VL.ARZF4	705
19.30.5 VL.ARZQ1 TO VL.ARZQ4	706
19.30.6 VL.BUSFF	707
19.30.7 VL.CMD	708
19.30.8 VL.CMDU	709
19.30.9 VL.ERR	710
19.30.10 VL.FB	711
19.30.11 VL.FBFILTER	712
19.30.12 VL.FBSOURCE	713
19.30.13 VL.FBUNFILTERED	714
19.30.14 VL.FF	715
19.30.15 VL.FFDELAY	716
19.30.16 VL.GENMODE	717
19.30.17 VL.KBUSFF	718
19.30.18 VL.KI	719
19.30.19 VL.KO	720
19.30.20 VL.KP	721
19.30.21 VL.KVFF	723
19.30.22 VL.LIMITN	724
19.30.23 VL.LIMITP	726
19.30.24 VL.LMJR	727
19.30.25 VL.MODEL	728
19.30.26 VL.OBSBW	729
19.30.27 VL.OBSMODE	730
19.30.28 VL.THRESH	731
19.30.29 VL.VFTHRESH	733

19.30.1 VL.ARPF1 TO VL.ARPF4

General Information	
Type	R/W Parameter
Description	Sets the natural frequency of the pole (denominator) of anti-resonance (AR) filters 1, 2, 3, and 4; active in opmodes 1 (velocity) and 2 (position) only.
Units	Hz
Range	5 to 5,000 Hz
Default Value	500 Hz
Data Type	Float
See Also	VL.ARPQ1 TO VL.ARPQ4 (→ p. 702), VL.ARZF1 TO VL.ARZF4 (→ p. 705), Sets the Q of the zero (numerator) of anti-resonance filter #1; active in opmodes 1 (velocity) and 2 (position) only. (→ p. 706)
Start Version	M_01-02-00-000

Fieldbus	Index/Subindex	Object Start Version
EtherCAT COE and CANopen	3406h/1	VL.ARPF1
	3406h/2	VL.ARPF2
	3406h/3	VL.ARPF3
	3406h/4	VL.ARPF4
		M_01-02-00-000

Description

VL.ARPF1 sets the natural frequency of the pole (denominator) of AR filter 1. This value is F_p in the approximate transfer function of the filter:

$$ARx(s) = [s^2 / (2\pi F_z)^2 + s / (Q_z 2\pi F_z) + 1] / [s^2 / (2\pi F_p)^2 + s / (Q_p 2\pi F_p) + 1]$$

The following block diagram describes the AR filter function; note that AR1 and AR2 are in the forward path, while AR3 and AR4 are applied to feedback:

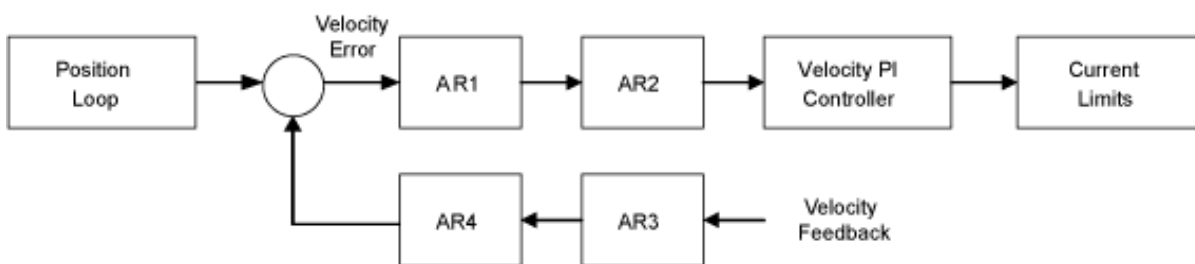

AR1, AR2, AR3, and AR4 are used in velocity and position mode, but are disabled in torque mode.

Discrete time transfer function (applies to all AR filters)

The velocity loop compensation is actually implemented as a digital discrete time system function on the DSP. The continuous time transfer function is converted to the discrete time domain by a backward Euler mapping:

$$s \approx (1-z^{-1})/t, \text{ where } t = 62.5 \mu\text{s}$$

The poles are prewarped to F_p and the zeros are prewarped to F_z .

Related Topics

1 Velocity Loop

19.30.2 VL.ARPQ1 TO VL.ARPQ4

General Information	
Type	R/W Parameter
Description	Sets the Q of the pole (denominator) of anti-resonance (AR) filter 1; active in opmodes 1 (velocity) and 2 (position) only.
Units	None
Range	0.2 to 20
Default Value	0.5
Data Type	Float
See Also	VL.ARPF1 TO VL.ARPF4 (→ p. 700), VL.ARZF1 TO VL.ARZF4 (→ p. 705), VL.ARZQ1 TO VL.ARZQ4 (→ p. 706)
Start Version	M_01-02-00-000

Fieldbus	Index/Subindex	Object Start Version
EtherCAT COE and CANopen	3406h/5	VL.ARPQ1
	3406h/6	VL.ARPQ2
	3406h/7	VL.ARPQ3
	3406h/8	VL.ARPQ4
		M_01-02-00-000

Description

VL.ARPQ1 sets the Q (quality factor) of the pole (denominator) of AR filter 1. This value is Q_p in the approximate transfer function of the filter:

$$AR_x(s) = [s^2 / (2\pi F_z)^2 + s / (Q_z 2\pi F_z) + 1] / [s^2 / (2\pi F_p)^2 + s / (Q_p 2\pi F_p) + 1]$$

The following block diagram describes the AR filter function; note that AR1 and AR2 are in the forward path, while AR3 and AR4 are applied to feedback:

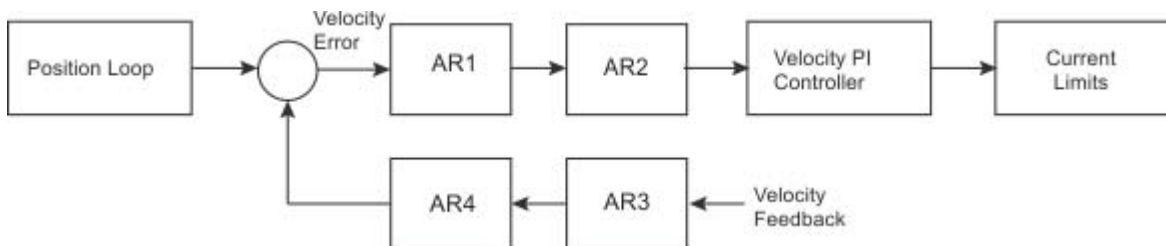

AR1, AR2, AR3, and AR4 are used in velocity and position mode, but are disabled in torque mode.

Discrete time transfer function (applies to all AR filters)

The velocity loop compensation is actually implemented as a digital discrete time system function on the DSP. The continuous time transfer function is converted to the discrete time domain by a backward Euler mapping:

$$s \approx (1-z^{-1})/t, \text{ where } t = 62.5 \mu\text{s}$$

The poles are prewarped to F_p and the zeros are prewarped to F_z .

Related Topics

1 Velocity Loop

19.30.3 VL.ARTYPE1 TO VL.ARTYPE4

General Information	
Type	NV Parameter
Description	Indicates the method used to calculate BiQuad coefficients; active in opmodes 1 (velocity) and 2 (position) only.
Units	N/A
Range	0
Default Value	0
Data Type	U8
See Also	N/A
Start Version	M_01-00-00-000

Fieldbus	Index/Subindex	Object Start Version
EtherCAT COE and CANopen	3405h/1	VL.ARTYPE1
	3405h/2	VL.ARTYPE2
	3405h/3	VL.ARTYPE3
	3405h/4	VL.ARTYPE4
		M_01-02-00-000

Description

These parameters indicate the method used to calculate the biquad coefficients VL.ARPFx, VL.ARPQx, VL.ARZFx, and VL.ARZQx. A value of 0 indicates that the coefficients are set directly. This parameter has no effect on the filter itself, but is only used to determine the original design parameters. Currently, only the value of 0 is supported.

Related Topics

- 1 Velocity Loop

19.30.4 VL.ARZF1 TO VL.ARZF4

General Information	
Type	R/W Parameter
Description	Sets the natural frequency of the zero (numerator) of anti-resonance (AR)filter 1; active in opmodes 1 (velocity) and 2 (position) only.
Units	Hz
Range	5 to 5,000 Hz
Default Value	500 Hz
Data Type	Float
See Also	VL.ARPF1 TO VL.ARPF4 (→ p. 700), VL.ARPQ1 TO VL.ARPQ4 (→ p. 702), VL.ARZQ1 TO VL.ARZQ4 (→ p. 706)
Start Version	M_01-02-00-000

Fieldbus	Index/Subindex	Object Start Version
EtherCAT COE and CANopen	3406h/9	VL.ARZF1
	3406h/A	VL.ARZF2
	3406h/B	VL.ARZF3
	3406h/C	VL.ARZF4
		M_01-02-00-000

Description

VL.ARZF1 sets the natural frequency of the zero (numerator) of AR filter 1. This value is F_z in the approximate transfer function of the filter:

$$AR_x(s) = [s^2 / (2\pi F_z)^2 + s / (Q_z 2\pi F_z) + 1] / [s^2 / (2\pi F_p)^2 + s / (Q_p 2\pi F_p) + 1]$$

The following block diagram describes the AR filter function; note that AR1 and AR2 are in the forward path, while AR3 and AR4 are applied to feedback:

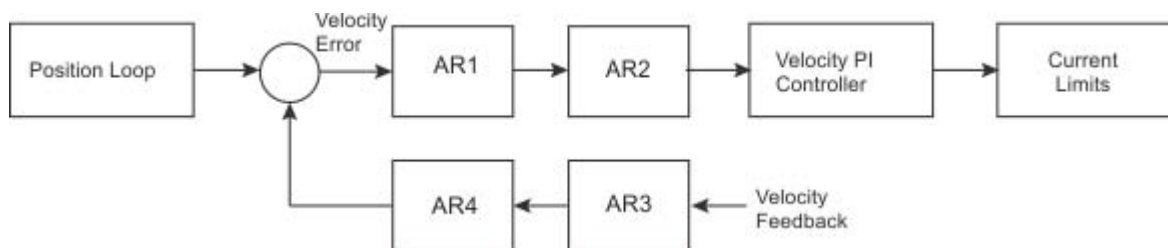

AR1, AR2, AR3, and AR4 are used in velocity and position mode, but are disabled in torque mode.

Discrete time transfer function (applies to all AR filters)

The velocity loop compensation is actually implemented as a digital discrete time system function on the DSP. The continuous time transfer function is converted to the discrete time domain by a backward Euler mapping:

$$s \approx (1-z^{-1})/t, \text{ where } t = 62.5 \mu\text{s}$$

The poles are prewarped to F_p and the zeros are prewarped to F_z .

Related Topics

- 1 Velocity Loop

19.30.5 VL.ARZQ1 TO VL.ARZQ4

General Information	
Type	R/W Parameter
Description	Sets the Q of the zero (numerator) of anti-resonance filter #1; active in opmodes 1 (velocity) and 2 (position) only.
Units	N/A
Range	0.1 to 5
Default Value	0.5
Data Type	Float
See Also	VL.ARPF1 TO VL.ARPF4 (→ p. 700), VL.ARPQ1 TO VL.ARPQ4 (→ p. 702), VL.ARZF1 TO VL.ARZF4 (→ p. 705)
Start Version	M_01-02-00-000

Fieldbus	Index/Subindex	Object Start Version
EtherCAT COE and CANopen	3406h/D	VL.ARZQ1
	3406h/E	VL.ARZQ2
	3406h/F	VL.ARZQ3
	3406h/10	VL.ARZQ4
		M_01-02-00-000

Description

VL.ARZQ1 sets the Q (quality factor) of the zero (numerator) of AR filter 1. This value is Q_z in the approximate transfer function of the filter:

$$AR1(s) = [s^2 / (2\pi F_z)^2 + s / (Q_z 2\pi F_z) + 1] / [s^2 / (2\pi F_p)^2 + s / (Q_p 2\pi F_p) + 1]$$

The following block diagram describes the AR filter function; note that AR1 and AR2 are in the forward path, while AR3 and AR4 are applied to feedback:

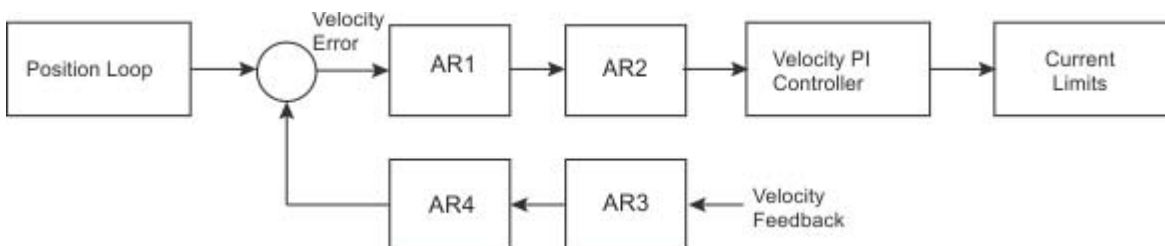

AR1, AR2, AR3 and AR4 are used in velocity and position mode, but are disabled in torque mode.

Discrete time transfer function (applies to all AR filters)

The velocity loop compensation is actually implemented as a digital discrete time system function on the DSP. The continuous time transfer function is converted to the discrete time domain by a backward Euler mapping:

$$s \approx (1-z^{-1})/t, \text{ where } t = 62.5 \mu\text{s}.$$

The poles are prewarped to F_p and the zeros are prewarped to F_z .

Related Topics

- 1 Velocity Loop

19.30.6 VL.BUSFF

General Information	
Type	R/O Parameter
Description	Displays the velocity loop feedforward value injected by the field-bus; active in opmodes 1 (velocity) and 2 (position) only.
Units	Depends on UNIT.VROTARY (pg 1) or UNIT.VLINEAR (pg 1) Rotary: rpm, rps, deg/s, (custom units)/s, rad/s Linear: counts/s, mm/s, µm/s, (custom units)/s
Range	0.0 to VL.LIMITP (→ p. 726)
Default Value	0.0
Data Type	Float
See Also	VL.FF (→ p. 715), VL.KBUSFF (→ p. 718)
Start Version	M_01-00-00-000

Fieldbus	Index/Subindex	Object Start Version
EtherCAT COE and CANopen	60B1h/0	M_01-00-00-000

Description

This parameter displays the velocity loop feedforward value injected by the fieldbus.

Related Topics

- 1 Velocity Loop

19.30.7 VL.CMD

General Information	
Type	R/O Parameter
Description	Reads the actual velocity command; active in opmodes 1 (velocity) and 2 (position) only.
Units	Depends on UNIT.VROTARY (pg 1) or UNIT.VLINEAR (pg 1) Rotary: rpm, rps, deg/s, (custom units)/s, rad/s Linear: counts/s, mm/s, $\mu\text{m/s}$, (custom units)/s
Range	N/A
Default Value	N/A
Data Type	Float
See Also	VL.FB (→ p. 711), VL.CMDU (→ p. 709), VL.LIMITP (→ p. 726), VL.LIMITN (→ p. 724)
Start Version	M_01-00-00-000

Fieldbus	Index/Subindex	Object Start Version
EtherCAT COE and CANopen	606Bh/0	M_01-00-00-000

Description

VL.CMD returns the actual velocity command as it is received in the velocity loop entry after all velocity limits (such as VL.LIMITN (→ p. 724) and VL.LIMITP (→ p. 726)). See velocity loop design diagram for more details.

Related Topics

- 1 Velocity Loop
- 1 Position Loop
- 1 Block Diagrams

19.30.8 VL.CMDU

General Information	
Type	R/W Parameter
Description	Sets the user velocity command; active in opmodes 1 (velocity) and 2 (position) only.
Units	Depends on UNIT.VROTARY (pg 1) or UNIT.VLINEAR (pg 1) Rotary: rpm, rps, deg/s, custom units/s, rad/s Linear: counts/s, mm/s, $\mu\text{m/s}$, custom units/s
Range	Rotary -15,000.000 to 15,000.000 rpm -250.000 to 250.000 rps -90000.000 to 90000.000 deg/s -1250.000 to 1250.000 custom units/s -1570.796 to 1570.796 rad/s Linear -1,073,741,824,000.000 to 1,073,741,824,000.000 counts/s -8,000.000 to 8,000.000 mm/s -8,000,000.000 to 8,000,000.000 $\mu\text{m/s}$ -1,250.000 to 1,250.000 custom units/s
Default Value	0
Data Type	Float
See Also	VL.FB (→ p. 711), VL.CMD (→ p. 708), DRV.OPMODE (→ p. 414), DRV.CMDSOURCE (→ p. 362), VL.LIMITN (→ p. 724), VL.LIMITP (→ p. 726)
Start Version	M_01-00-00-000

Fieldbus	Index/Subindex	Object Start Version
EtherCAT COE and CANopen	60FFh/0	M_01-00-00-000

Description

VL.CMDU sets the user velocity command. When DRV.OPMODE (→ p. 414) is set to 1 (velocity loop) and DRV.CMDSOURCE (→ p. 362) is set to 0 (TCP/IP channel), then setting this value when the drive is enabled will cause the drive to rotate at the required velocity.

Related Topics

- 1 Velocity Loop

19.30.9 VL.ERR

General Information	
Type	R/O Parameter
Description	Sets the velocity error; active in opmodes 1 (velocity) and 2 (position) only.
Units	Depends on UNIT.VROTARY (pg 1) or UNIT.VLINEAR (pg 1) Rotary: rpm, rps, deg/s, (custom units)/s, rad/s Linear: counts/s, mm/s, µm/s, (custom units)/s
Range	N/A
Default Value	N/A
Data Type	Float
See Also	VL.CMD (→ p. 708), VL.FB (→ p. 711)
Start Version	M_01-00-00-000

Fieldbus	Index/Subindex	Object Start Version
EtherCAT COE and CANopen	3407h/4	M_01-00-00-000

Description

VL.ERR sets the velocity error. It is calculated in the velocity loop as the difference between VL.CMD (→ p. 708) and VL.FB (→ p. 711).

Related Topics

- 1 Velocity Loop

19.30.10 VL.FB

General Information	
Type	R/O Parameter
Description	Reads the velocity feedback; active in opmodes 1 (velocity) and 2 (position) only.
Units	Depends on UNIT.VROTARY (pg 1) or UNIT.VLINEAR (pg 1) Rotary: rpm, rps, deg/s, (custom units)/s, rad/s Linear: counts/s, mm/s, $\mu\text{m/s}$, (custom units)/s
Range	N/A
Default Value	N/A
Data Type	Float
See Also	VL.CMDU (→ p. 709)
Start Version	M_01-00-00-000

Fieldbus	Index/Subindex	Object Start Version
EtherCAT COE and CANopen	3618h/0 606Ch/0	M_01-00-00-000

Description

VL.FB returns the velocity feedback as it is received in the velocity loop, after passing through Filter 3 and Filter 4.

Related Topics

Velocity Loop

19.30.11 VL.FBFILTER

General Information	
Type	R/O Parameter
Description	Filters VL.FB (→ p. 711) value; active in opmodes 1 (velocity) and 2 (position) only.
Units	Depends on UNIT.VROTARY (pg 1) or UNIT.VLINEAR (pg 1) Rotary: rpm, rps, deg/s, (custom units)/s, rad/s Linear: counts/s, mm/s, µm/s, (custom units)/s
Range	N/A
Default Value	N/A
Data Type	Float
See Also	VL.FB (→ p. 711)
Start Version	M_01-00-00-000

Fieldbus	Index/Subindex	Object Start Version
EtherCAT COE and CANopen	3407h/1	M_01-00-00-000

Description

This parameter returns the same value as VL.FB (→ p. 711), filtered through a 10 Hz filter.

Related Topics

- 1 Velocity Loop

19.30.12 VL.FBSOURCE

General Information	
Type	NV Parameter
Description	Sets feedback source for the velocity loop; active in opmodes 1 (velocity) and 2 (position) only.
Units	N/A
Range	0 to 1
Default Value	0
Data Type	Integer
See Also	PL.FBSOURCE (→ p. 626)
Start Version	M_01-00-00-000

Fieldbus	Index/Subindex	Object Start Version
EtherCAT COE and CANopen	51AEh/0	M_01-00-00-000

Description

This parameter determines the feedback source to be used by the velocity loop. A value of 0 selects the primary feedback, and 1 selects the secondary feedback.

Related Topics

- 1 Velocity Loop

19.30.13 VL.FBUNFILTERED

General Information	
Type	R/O Parameter
Description	Reads the velocity feedback.
Units	Depends on UNIT.VROTARY or UNIT.VLINEAR, UNIT.ACCLINEAR Rotary: rpm, rps, deg/s, (custom units)/s, rad/s Linear: counts/s, mm/s, $\mu\text{m/s}$, (custom units)/s
Range	N/A
Default Value	N/A
Data Type	Float
See Also	VL.FB (→ p. 711), VL.FBFILTER (→ p. 712)
Start Version	M_01-03-06-000

Description

VL.FBUNFILTERED reads the raw velocity feedback before any filters affect the value of this feedback.

Related Topics

Velocity Loop

19.30.14 VL.FF

General Information	
Type	R/O Parameter
Description	Displays the velocity loop overall feedforward value; active in opmodes 1 (velocity) and 2 (position) only.
Units	Depends on or Rotary: rpm, rps, deg/s, (custom units)/s, rad/s Linear: counts/s, mm/s, $\mu\text{m/s}$, (custom units)/s
Range	0 to VL.LIMITP (→ p. 726)
Default Value	0
Data Type	Float
See Also	VL.KBUSFF (→ p. 718)
Start Version	M_01-00-00-000

Description

This parameter displays the velocity loop overall feedforward value.

Related Topics

1 Velocity Loop

VL.KVFF (→ p. 723)

19.30.15 VL.FFDELAY

General Information	
Type	R/W Parameter
Description	Sets the delay time for the velocity feedforward integrator component.
Units	Microseconds
Range	0, 100 to 625,000
Default Value	0
Data Type	Integer
Start Version	M_01-13-01-000

Description

VL.FFDELAY sets the delay applied to the velocity feedforward term that is passed into the velocity loop integrator. The delay is applied to the velocity feedforward, and then subtracted from the current velocity feedforward term. This difference is the value fed into the velocity loop integrator. If tuned correctly, this delay will help reduce position following error and velocity following error.

This filter is considered a feedforward. For best results it should be set in conjunction with PL.PDELAY (→ p. 634).

After making an approximation of the Open Loop bandwidth (Hz) in the Performance Servo Tuner, calculate VL.FFDELAY:

$$VL.FFDELAY = 1 / (\text{Open Loop BW (Hz)} * 2\pi) * 1,000,000$$

NOTE

1,000,000 = seconds to microseconds

Related Topics

PL.PDELAY (→ p. 634)

1 Velocity Loop

19.30.16 VL.GENMODE

General Information	
Type	NV Parameter
Description	Selects mode of velocity generation (Observer, d/dt); active in opmodes 1 (velocity) and 2 (position) only.
Units	N/A
Range	0 to 1
Default Value	0
Data Type	Integer
Start Version	M_01-00-00-000

Fieldbus	Index/Subindex	Object Start Version
EtherCAT COE and CANopen	51B0h/0	M_01-00-00-000

Description

This parameter is used to select the velocity generator mode.

Mode	Description
0	d/dt mode: The derivative of the mechanical angle of the drive is fed to a first order low pass.
1	Luenberger Observer mode

Related Topics

- 1 Velocity Loop

19.30.17 VL.KBUSFF

General Information	
Type	R/W Parameter
Description	Sets the velocity loop acceleration feedforward gain value; active in opmodes 1 (velocity) and 2 (position) only.
Units	NA
Range	0.0 to 2.0
Default Value	0.0
Data Type	Float
See Also	VL.BUSFF (→ p. 707)
Start Version	M_01-00-00-000

Fieldbus	Index/Subindex	Object Start Version
EtherCAT COE and CANopen	3407h/3	M_01-00-00-000

Description

This parameter sets the gain for the acceleration feedforward (a scaled second derivative of the position command is added to the velocity command value).

The nominal feedforward value can be multiplied by this gain value.

This will have affect only when using position mode (DRV.OPMODE (→ p. 414) = 2).

Related Topics

- 1 Velocity Loop

19.30.18 VL.KI

General Information	
Type	NV Parameter
Description	Sets the velocity loop integral gain for the PI controller; active in opmodes 1 (velocity) and 2 (position) only.
Units	Hz
Range	0 to 1,000 Hz
Default Value	160 Hz
Data Type	Float
See Also	VL.KP (→ p. 721)
Start Version	M_01-00-00-000

Fieldbus	Index/Subindex	Object Start Version
EtherCAT COE and CANopen	354Dh/0	M_01-00-00-000

Description

VL.KI sets the integral gain of the velocity loop.

A factor of 2π is included in the time calculation, therefore a PI velocity loop with a constant error of 1 rps in which VL.KI is set to 160 and VL.KP (→ p. 721) is set to 1, will take $(1000/160)*2\pi$ ms to increase the integral gain to 1. Therefore, the total gain is 2 at this time (see velocity loop structure below).

Velocity Loop Structure

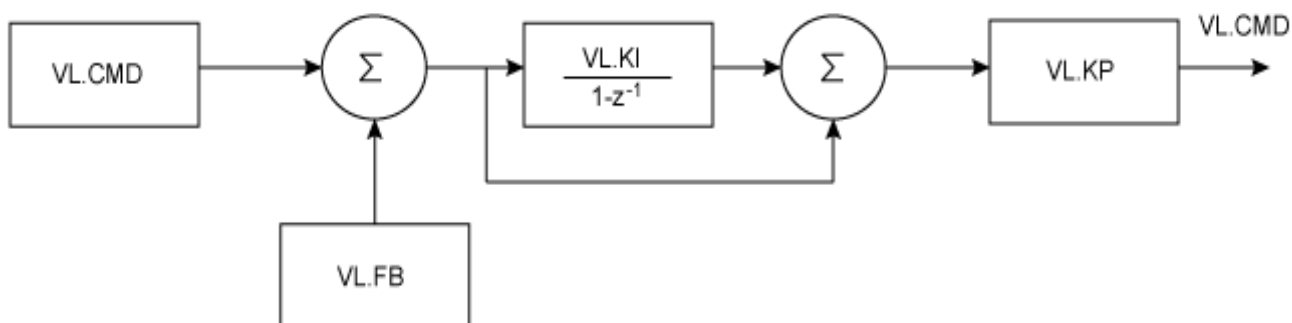

Related Topics

- 1 Velocity Loop

19.30.19 VL.KO

General Information	
Type	R/W Parameter
Description	Scales the observer velocity signal; active in opmodes 1 (velocity) and 2 (position) only.
Units	Internal
Range	0 to 65,535
Default Value	0
Data Type	Float
See Also	VL.MODEL (→ p. 728)
Start Version	M_01-00-01-000

Fieldbus	Index/Subindex	Object Start Version
EtherCAT COE and CANopen	51B3h/0	M_01-00-01-000

Description

VL.KO is used to scale the observer model to match the load. When VL.KO is tuned properly, Reads the observer velocity signal; active in opmodes 1 (velocity) and 2 (position) only. (→ p. 728) will match VL.FB (→ p. 711), except when there is an unspecified offset between the two.

Related Topics

- 1 Velocity Loop

19.30.20 VL.KP

General Information	
Type	NV Parameter
Description	Sets velocity loop proportional gain for the PI controller; active in opmodes 1 (velocity) and 2 (position) only.
Units	A/(rad/sec)
Range	0.001 to 2,147,483.008
Default Value	1
Data Type	Float
See Also	VL.KI (→ p. 719)
Start Version	M_01-00-00-000

Fieldbus	Index/Subindex	Object Start Version
EtherCAT COE and CANopen	3548h/0	M_01-00-00-000

Description

VL.KP sets the proportional gain of the velocity loop.

The idealized velocity loop bandwidth in Hz is:

Rotary motor:

$$\text{Bandwidth (Hz)} = \text{VL.KP} * K_t / (2\pi * J_m)$$

Where:

K_t = motor torque constant, in units of Nm/Arms

J_m = motor inertia, in units of kg*m²

Linear motor:

$$\text{Bandwidth (Hz)} = \text{VL.KP} * K_t / (\text{Motor Pitch (mm)} * J_m)$$

Where:

K_t = motor torque constant, in units of Nm/Arms

J_m = motor inertia, in units of kg

The drive uses the same control loop for both linear and rotary motors. VL.KP units are in Arms/(rad/s). If you want to tune in units of Arms/(mm/s), then you must manually convert the units.

The diagram below shows how linear motors are implemented at the control loop level.

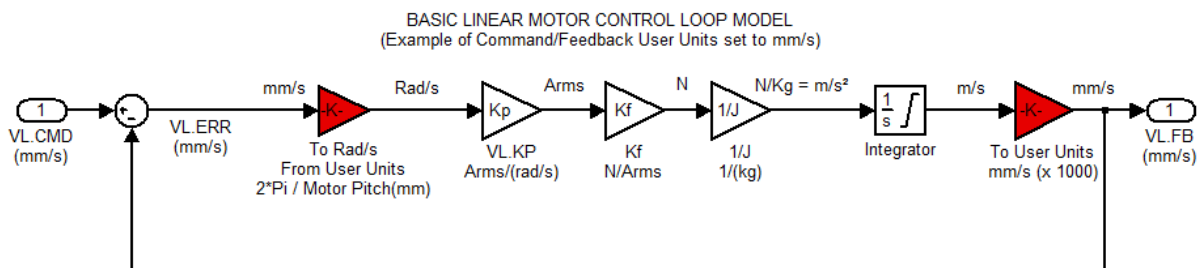

The red blocks are automatically handled at the drive level.

2π radians is the linear equivalent of one full mechanical revolution of a rotary motor - and is equal to the MOTOR.PITCH of a linear motor.

Example

To convert VL.KP = 0.320 Arms/(rad/s) to Arms/(mm/s), where MOTOR.PITCH is 32 mm:

$$\text{VL.KP} = 0.320 \text{ Arm /rad/s} * (2\pi \text{ rad} / 32\text{mm MOTOR.PITCH})$$

$$\text{VL.KP} = 0.32 * 2\pi / 32 = 0.063 \text{ Arms / (mm/s)}$$

Related Topics

Velocity Controller Environment Block Diagram

19.30.21 VL.KVFF

General Information	
Type	R/W Parameter
Description	Sets the velocity loop velocity feedforward gain value; active in opmodes 1 (velocity) and 2 (position) only.
Units	NA
Range	0.0 to 2.0
Default Value	0.0
Data Type	Float
See Also	VL.FF (→ p. 715)
Start Version	M_01-00-00-000

Fieldbus	Index/Subindex	Object Start Version
EtherCAT COE and CANopen	3407h/2 354Bh/0	M_01-00-00-000

Description

This parameter sets the gain for the velocity feedforward (a scaled derivative of the position command is added to the velocity command value). The nominal feedforward value can be multiplied by this gain value.

This parameter is only used in the position mode (DRV.OPMODE (→ p. 414) = 2).

Related Topics

- 1 Velocity Loop

19.30.22 VL.LIMITN

General Information	
Type	NV Parameter
Description	Sets the velocity lower limit; active in opmodes 1 (velocity) and 2 (position) only.
Units	Depends on UNIT.VROTARY (pg 1) or UNIT.VLINEAR (pg 1) Rotary: rpm, rps, deg/s, custom units/s, rad/s Linear: counts/s, mm/s, µm/s, custom units/s
Range	Range may be limited by ECCN 3A225 Limitations for Induction Motors (→ p. 1) Rotary: -15,000.000 to 0.000 rpm -250.000 to 0.000 rps -90,000.000 to 0.000 deg/s -1,250.000 to 0.000 custom units/s -1570.796 to 0.000 rad/s Linear: -1,073,741,824,000.000 to 0.000 counts/s -250.000*MOTOR.PITCH (→ p. 599) to 0.000 mm/s -250,000.000*MOTOR.PITCH (→ p. 599) to 0.000 µm/sec -1,250.000 to 0.000 custom units/s
Default Value	Rotary: -3,000.000 rpm -50.000 rps -18,000.002 deg/s -250.000 (custom units)/s -314.159 rad/s Linear: -0.050 counts/s -50*MOTOR.PITCH (→ p. 599) mm/s -50,000.004*MOTOR.PITCH µm/sec -250.000 custom units/s
Data Type	Float
See Also	VL.LIMITP (→ p. 726), VL.CMD (→ p. 708)
Start Version	M_01-00-00-000

Fieldbus	Index/Subindex	Object Start Version
EtherCAT COE and CANopen	3623h/0	M_01-00-00-000

Description

VL.LIMITN sets the velocity command negative limit.

If the input to the velocity loop is lower than VL.LIMITN, then the actual velocity command VL.CMD (→ p. 708) is limited by the value of VL.LIMITN.

NOTE

ECCN 3A255 imposes special limitations on operating speed for induction motors. See ECCN 3A225 Limitations for Induction Motors (→ p. 1).

Related Topics

- 1 Velocity Loop

19.30.23 VL.LIMITP

General Information	
Type	NV Parameter
Description	Sets the velocity high limit; active in opmodes 1 (velocity) and 2 (position) only.
Units	Depends on UNIT.VROTARY (pg 1) or UNIT.VLINEAR (pg 1) Rotary: rpm, rps, deg/s, custom units/s, rad/s Linear: counts/s, mm/s, µm/s, custom units/s
Range	Range may be limited by ECCN 3A225 Limitations for Induction Motors (→ p. 1) Rotary: 0.000 to 15,000.000 rpm 0.000 to 250.000 rps 0.000 to 90,000.000 deg/s 0.000 to 1,250.000 custom units/s 0.000 to 1570.796 rad/s Linear: 0.000 to 1,073,741,824,000.000 counts/s 0.000 to 250.000*MOTOR.PITCH (→ p. 599) mm/sec 0.000 to 250,000.000*MOTOR.PITCH (→ p. 599) µm/s 0.000 to 1,250.000 custom units/s
Default Value	Rotary: 3,000.000 rpm 50.000 rps 18,000.002 deg/s 250.000 (custom units)/s 314.159 rad/s Linear: 0.050 counts/s 50.000*MOTOR.PITCH (→ p. 599) mm/sec 50,000.004*MOTOR.PITCH µm/sec 250.000 custom units/s
Data Type	Float
See Also	VL.LIMITN (→ p. 724), VL.CMD (→ p. 708)
Start Version	M_01-00-00-000

Fieldbus	Index/Subindex	Object Start Version
EtherCAT COE and CANopen	3622h/0	M_01-00-00-000

Description

VL.LIMITP sets the velocity command positive limit.

If the input to the velocity loop is higher than VL.LIMITP, then the actual velocity command VL.CMD (→ p. 708) is limited by the value of VL.LIMITP.

NOTE

ECCN 3A255 imposes special limitations on operating speed for induction motors. See ECCN 3A225 Limitations for Induction Motors (→ p. 1).

Related Topics

- 1 Velocity Loop

19.30.24 VL.LMJR

General Information	
Type	NV Parameter
Description	Sets the ratio of the estimated load moment of inertia relative to the motor moment of inertia; active in opmodes 1 (velocity) and 2 (position) only.
Units	NA
Range	0 to 100.0
Default Value	0
Data Type	Float
See Also	IL.FF (→ p. 535)
Start Version	M_01-00-00-000

Fieldbus	Index/Subindex	Object Start Version
EtherCAT COE and CANopen	51B8h/0	M_01-00-00-000

Description

This parameter is used in the internal calculation of the current loop acceleration feed forward gain value.

Related Topics

- 1 Velocity Loop

19.30.25 VL.MODEL

General Information	
Type	R/O Parameter
Description	Reads the observer velocity signal; active in opmodes 1 (velocity) and 2 (position) only.
Units	Depends on UNIT.VROTARY or UNIT.VLINEAR, UNIT.ACCLINEAR Rotary: rpm, rps, deg/s, (custom units)/s, rad/s Linear: counts/s, mm/s, $\mu\text{m/s}$, (custom units)/s
Range	N/A
Default Value	N/A
Data Type	Float
See Also	VL.FB (→ p. 711), VL.KO (→ p. 720)
Start Version	M_01-00-01-000

Description

VL.MODEL is the observer velocity output. When VL.KO (→ p. 720) is tuned properly, VL.MODEL will match VL.FB (→ p. 711), except when there is an unspecified offset between the two.

Related Topics

- 1 Velocity Loop

19.30.26 VL.OBSBW

General Information	
Type	NV Parameter
Description	Sets the bandwidth of the observer in Hz.
Units	Hz
Range	10 to 4,000 Hz
Default Value	30 Hz
Data Type	Float
See Also	N/A
Start Version	M_01-03-00-004

Fieldbus	Index/Subindex	Object Start Version
EtherCAT COE and CANopen	51BAh/0	M_01-03-00-004

Description

This parameter sets the bandwidth of the observer in Hz. The observer passes the velocity feedback through a PID control loop that behaves like a low-pass filter with a bandwidth of VL.OBSBW.

Related Topics

- 1 Velocity Loop

19.30.27 VL.OBSMODE

General Information	
Type	NV Parameter
Description	Sets the observer operating mode.
Units	N/A
Range	0 to 1
Default Value	0
Data Type	Integer
See Also	N/A
Start Version	M_01-03-00-004

Fieldbus	Index/Subindex	Object Start Version
EtherCAT COE and CANopen	51BBh/0	M_01-03-00-004

Description

This parameter sets the observer operating mode. When VL.OBSMODE = 0, the observer is not part of the control loop; that is, VL.FB is used as the velocity feedback signal to the velocity loop. When VL.OBSMODE = 1, the observer is part of the control loop; VL.MODEL is used as the velocity feedback signal.

Related Topics

- 1 Velocity Loop

19.30.28 VL.THRESH

General Information	
Type	NV Parameter
Description	Sets the user over speed fault level.
Units	Depends on UNIT.VROTARY (pg 1) or UNIT.VLINEAR (pg 1) Rotary: rpm, rps, deg/s, custom units/s, rad/s Linear: counts/s, mm/s, $\mu\text{m/s}$, custom units/s
Range	Rotary: 0.000 to 15,000.000 rpm 0.000 to 250.000 rps 0.000 to 90,000.000 deg/s 0.000 to 1,250.000 custom units/s 0.000 to 1,570.796 rad/s Linear: 0.000 to 1,073,741,824,000.000 counts/s 0.000 to 250.000*MOTOR.PITCH (\rightarrow p. 599) mm/s 0.000 to 250,000.000*MOTOR.PITCHMOTOR.PITCH (\rightarrow p. 599) $\mu\text{m/s}$ 0.000 to 1,250.000 custom units/s
Default Value	Rotary: 3,600 rpm 60 rps 21,600.000 deg/s 300.000 custom units/s 376.991 rad/s Linear: 0.060 counts/s 60.000*MOTOR.PITCH (\rightarrow p. 599) mm/s 60,000.04*MOTOR.PITCHMOTOR.PITCH (\rightarrow p. 599) $\mu\text{m/s}$ 300.000 custom units/s
Data Type	Float
Start Version	M_01-00-00-000

Fieldbus	Index/Subindex	Object Start Version
EtherCAT COE and CANopen	3627h/0	M_01-00-00-000

Description

VL.THRESH sets the user overspeed fault threshold. This threshold becomes the overall overspeed fault threshold (VL.VFTHRESH) if it is less than the motor speed threshold ($1.2 \times \text{MOTOR.VMAX}$), and for $\text{MOTOR.TYPE} = 6$ if it is less than the motor back EMF overspeed threshold ($(1.02 \times 1000 \times \text{VBUS.OVFTHRESH}) / (\text{MOTOR.KE} \times \sqrt{2})$).

The value is considered an absolute value, hence it applies for both negative and positive velocities.

Example

VL.THRESH is set to 600 rpm. A velocity (VL.FB (\rightarrow p. 711)) of 700 rpm will generate an over speed fault.

Related Topics

1 Velocity Loop | VL.CMD (→ p. 708) | VL.CMDU (→ p. 709) | VL.VFTHRESH (→ p. 733)

19.30.29 VL.VFTHRESH

General Information	
Type	R/O Parameter
Description	Reads the overall overspeed fault threshold.
Units	N/A
Range	N/A
Default Value	N/A
Data Type	Float
Start Version	M_01-10-03-000

Description

This parameter reports the overall overspeed fault threshold. Whichever of the following thresholds has the smallest value is used as the overall overspeed fault threshold:

- User overspeed threshold (VL.THRESH).
- Motor mechanical overspeed threshold ($1.2 \times \text{MOTOR.VMAX}$)
- If $\text{MOTOR.TYPE} = 6$, the motor back EMF overspeed threshold ($((1.02 \times 1000 \times \text{VBUS.OVFTHRESH}) / (\text{MOTOR.KE} \times \text{sqrt}(2)))$).

Related Topics

1 Velocity Loop | VL.THRESH (→ p. 731) | MOTOR.VMAX (→ p. 613)

19.31 WS Parameters

This section describes the WS parameters.

19.31.1 WS.ARM	735
19.31.2 WS.CHECKMODE	736
19.31.3 WS.CHECKT	737
19.31.4 WS.CHECKV	738
19.31.5 WS.DISARM	739
19.31.6 WS.DISTMAX	740
19.31.7 WS.DISTMIN	741
19.31.8 WS.FREQ	742
19.31.9 WS.IMAX	743
19.31.10 WS.MODE	744
19.31.11 WS.NUMLOOPS	745
19.31.12 WS.STATE	746
19.31.13 WS.T	747
19.31.14 WS.TDELAY1	748
19.31.15 WS.TDELAY2	749
19.31.16 WS.TDELAY3	750
19.31.17 WS.TDELAY4	751
19.31.18 WS.TIRAMP	752
19.31.19 WS.TSTANDSTILL	753
19.31.20 WS.VTHRESH	754

19.31.1 WS.ARM

General Information	
Type	Command
Description	Sets wake and shake to start at the next drive enable.
Units	N/A
Range	N/A
Default Value	N/A
Data Type	N/A
See Also	N/A
Start Version	M_01-01-00-101, M_01-02-00-000

Fieldbus	Index/Subindex	Object Start Version
EtherCAT COE and CANopen	3494h/6	M_01-00-00-000

*For Profinet, write a value of 0 into the PNU to execute a command.

Description

This command sets wake and shake to start at the next drive enable. Feedback type is not relevant for this command. If WS.STATE is 0 and the drive is disabled, then WS.STATE will change to 1 after issuing WS.ARM. With this command, wake and shake can be repeated if desired.

Related Topics

Wake and Shake Overview (→ p. 58)

19.31.2 WS.CHECKMODE

General Information	
Type	R/W Parameter
Description	Select the type of commutation check to execute after Wake and Shake finds a new commutation angle.
Units	N/A
Range	0 to 2
Default Value	1
Data Type	Integer
Start Version	M_01-07-00-000

Description

AKD PDMM supports several options to confirm a valid commutation after Wake and Shake has determined a new commutation angle. In some mechanical situations, such as if motion is inhibited, it is possible for Wake and Shake to select an incorrect angle. Commutation checks are designed to prevent unexpected motion if this occurs.

0 = No Commutation Check

If No Commutation Check is selected, neither passive nor active commutations checks will be executed.

1 = Active Commutation Check (default)

In the default Active Commutation Check mode, AKD PDMM will make a short torque move after an angle has been selected. If the motor fails to move in the expected direction, a fault will be generated.

2 = Passive Commutation Check

In the Passive Commutation Check mode, AKD PDMM will monitor torque commands and acceleration values for 10 revolutions after Wake and Shake has completed. During this time, a fault will be generated if unexpected motion is detected, such as if commanded torque and acceleration are in opposition directions. Note that this fault may also be reported if the motor experiences a large torque disturbance lasting longer than WS.CHECKT.

Related Topics

Wake and Shake Overview (→ p. 58) | WS.MODE (→ p. 744)

19.31.3 WS.CHECKT

General Information	
Type	R/W Parameter
Description	Sets the amount of time a communication error must be present before an error is thrown.
Units	ms
Range	0 to 10,000
Default Value	N/A
Data Type	U16
Start Version	M_01-06-03-000

Fieldbus	Index/Subindex	Object Start Version
EtherCAT COE and CANopen	5352h/0	M_01-06-03-000

Description

This parameter sets the amount of time a communication error must be present before an error is thrown. Commutation monitoring is disabled when this parameter is set to 0.

Related Topics

Wake and Shake Overview (→ p. 58) | WS.CHECKV (→ p. 738)

19.31.4 WS.CHECKV

General Information			
Type	R/W Parameter		
Description	This parameter sets the velocity threshold which has to be exceeded to activate commutation monitoring.		
Units	Depends on UNIT.VROTARY or UNIT.VLINEAR.		
Range	Unit	Rotary	Linear
	0	0 to 15,000 rpm	0 to 6,7108,864 counts/s
	1	0 to 250 rps	0 to 8,000 mm/s
	2	0 to 90,000 deg/s	0 to 589934 um/s
	3	0 to 1250 PIN/POUT	0 to 1250 PIN/POUT
Default Value	N/A		
Data Type	S32		
Start Version	M_01-06-03-000		

Description

This parameter sets the velocity threshold which has to be exceeded to activate commutation monitoring.

Related Topics

Wake and Shake Overview (→ p. 58) | WS.CHECKT (→ p. 737)

19.31.5 WS.DISARM

General Information	
Type	Command
Description	Cancels ARM requests and resets wake and shake to the IDLE state.
Units	N/A
Range	N/A
Default Value	N/A
Data Type	N/A
See Also	N/A
Start Version	M_01-04-00-000

*For Profinet, write a value of 0 into the PNU to execute a command.

Description

This command disables wake and shake immediately. Feedback type is not relevant for this command. If WS.ARM (→ p. 735) has been issued, the request to execute the wake and shake algorithm at the next enable is cancelled. WS.STATE (→ p. 746) is set to IDLE.

Related Topics

Wake and Shake Overview (→ p. 58)

19.31.6 WS.DISTMAX

General Information	
Type	R/W Parameter
Description	Sets maximum movement allowed for wake and shake.
Units	deg (position units)
Range	0 to 90 deg
Default Value	15 deg
Data Type	S64
See Also	N/A
Start Version	M_01-01-00-101, M_01-02-00-000

Fieldbus	Index/Subindex	Object Start Version
EtherCAT COE and CANopen	3494h/2	M_01-00-00-000

Description

This parameter sets the maximum movement that is allowed for finding commutation. If this value is too small, FFault and Warning Messages (→ p. 174), "Wake and Shake. Too much movement", may occur before wake and shake is finished. The bigger this value, the more movement is allowed for wake and shake. This value is application dependent.

Related Topics

Wake and Shake Overview (→ p. 58)

19.31.7 WS.DISTMIN

General Information	
Type	R/W Parameter
Description	Sets the minimum movement required for wake and shake.
Units	Actual position units
Range	0 to 90 deg
Default Value	1 deg
Data Type	S64
See Also	N/A
Start Version	M_01-01-00-101, M_01-02-00-000

Fieldbus	Index/Subindex	Object Start Version
EtherCAT COE and CANopen	36D1h/0	M_01-00-00-000

Description

This parameter sets the minimum movement that is required for commutation finding. If this value is too small, the the commutation finding might fail if too little current is used. The larger this value, the more movement is needed in order to avoid F473: "Wake and Shake: Too little movement".

Related Topics

Wake and Shake Overview (→ p. 58)

19.31.8 WS.FREQ

General Information	
Type	R/W
Description	Sets the sine frequency of excitation for WS.MODE 2.
Units	Hz
Range	0.01 - 8000
Default Value	10
Data Type	Float
Start Version	M_01-05-10-000

Description

This keyword sets the excitation frequency for Wake and Shake mode 2.

The default setting of 10Hz will work for almost all systems.

In cases where the load attached to the motor is much higher than the motor inertia (200:1) it may be necessary to lower the value of WS.FREQ.

Effects of lowering WS.FREQ:

- Wake and Shake Mode 2 will take longer to complete.
- A higher magnitude of motion will be seen on the motor because the motor has current applied in the same direction for a longer period of time.

Related Topics

WS.MODE (→ p. 744)

19.31.9 WS.IMAX

General Information	
Type	R/W Parameter
Description	Sets maximum current used for wake and shake.
Units	Arms
Range	0 to (lower value of MOTOR.IPEAK and DRV.IPEAK) Arms
Default Value	(half of maximum) Arms
Data Type	U16
See Also	MOTOR.IPEAK (→ p. 589), DRV.IPEAK (→ p. 401)
Start Version	M_01-01-00-101, M_01-02-00-000

Fieldbus	Index/Subindex	Object Start Version
EtherCAT COE and CANopen	3494h/1	M_01-00-00-000

Description

This parameter defines the maximum current used for wake and shake. If the selected current is too low, the minimum required movement may not occur. If the selected current is too high, the movement may be too fast (overspeed) or too large (over maximum movement).

The maximum of this parameter is the lower value of MOTOR.IPEAK and DRV.IPEAK. The default value of this parameter is the half of its maximum. This value depends on the specific application.

Related Topics

Wake and Shake Overview (→ p. 58)

19.31.10 WS.MODE

General Information	
Type	R/W Parameter
Description	Sets the method used for wake and shake.
Units	N/A
Range	0 to 1
Default Value	0
Data Type	U8
Start Version	M_01-01-00-101, M_01-02-00-000

Description

This parameter sets the method used for finding commutation.

0 = Standard wake and shake

Two iterations are used to find the correct angle in this mode. Coarse (current mode) and fine (velocity mode) iterations are done in a loop (WS.NUMLOOPS times). The average angle of all loops is calculated and used.

1 = Commutation alignment by fixed commutation vector (Zero Method)

The motor poles are set to 0, current mode is activated, and WS.IMAX is applied. The angle in which the motor settles is used for commutation. Other settings are restored (such as motor poles and operation mode).

Related Topics

Wake and Shake Overview (→ p. 58)

19.31.11 WS.NUMLOOPS

General Information	
Type	R/W Parameter
Description	Sets the number of repetitions for wake and shake.
Units	counts
Range	0 to 20 counts
Default Value	5 counts
Data Type	U8
See Also	N/A
Start Version	M_01-01-00-101, M_01-02-00-000

Fieldbus	Index/Subindex	Object Start Version
EtherCAT COE and CANopen	36E2h/0	M_01-00-00-000

Description

This parameter sets the maximum number of wake and shake repetitions. MOTOR.PHASE is calculated as mean value of all wake and shake repetitions.

Related Topics

Wake and Shake Overview (→ p. 58)

19.31.12 WS.STATE

General Information	
Type	R/O Parameter
Description	Reads wake and shake status.
Units	N/A
Range	N/A
Default Value	Only valid before the first enable occurs. 11 - for feedback types that do not require wake and shake 1 - for feedback types that require wake and shake
Data Type	U8
See Also	N/A
Start Version	M_01-01-00-101, M_01-02-00-000

Fieldbus	Index/Subindex	Object Start Version
EtherCAT COE and CANopen	3494h/5	M_01-00-00-000

Description

WS switches different current vectors and records position feedback in order to establish commutation alignment.

WS.STATE 0 = wake and shake successful (DONE).

WS.STATE 1 = wake and shake configured and will be done at next enable (ARMED).

WS.STATE 2 = wake and shake running. (ACTIVE)

WS.STATE 10 = error occurred during wake and shake (ERROR).

WS.STATE 11 = wake and shake not required (IDLE).

Related Topics

Wake and Shake Overview (→ p. 58)

19.31.13 WS.T

General Information	
Type	R/W Parameter
Description	Sets wake and shake current-vector appliance time.
Units	ms
Range	1 to 200 ms
Default Value	2 ms
Data Type	U8
See Also	WS.IMAX (→ p. 743), WS.DISTMAX
Start Version	M_01-01-00-101, M_01-02-00-000

Fieldbus	Index/Subindex	Object Start Version
EtherCAT COE and CANopen	36D0h/0	M_01-00-00-000

Description

This parameter defines the duration for each different current-vector while the coarse angle calculation. The move distance is proportional to the WS.T and WS.IMAX value.

Related Topics

Wake and Shake Overview (→ p. 58)

19.31.14 WS.TDELAY1

General Information	
Type	NV Parameter
Description	Delay for wake and shake timing.
Units	ms
Range	0 to 200 ms
Default Value	5 ms
Data Type	U8
See Also	N/A
Start Version	M_01-01-00-101, M_01-02-00-000

Fieldbus	Index/Subindex	Object Start Version
EtherCAT COE and CANopen	3683h/0	M_01-00-00-000

Description

WS.TDELAY1 defines the delay time of the wake and shake function. This time is a delay time between the switching of different current vectors during the wake and shake procedure. This time should be increased in the case of movement interferences between single current vectors.

Related Topics

Wake and Shake Overview (→ p. 58)

19.31.15 WS.TDELAY2

General Information	
Type	NV Parameter
Description	Sets the delay for wake and shake timing.
Units	ms
Range	0 to 200 ms
Default Value	50 ms
Data Type	U8
See Also	N/A
Start Version	M_01-01-00-101, M_01-02-00-000

Fieldbus	Index/Subindex	Object Start Version
EtherCAT COE and CANopen	3685h/0	M_01-00-00-000

Description

WS.TDELAY2 defines the delay between switching from coarse angle calculation to fine angle calculation during the wake and shake procedure. This time should be increased in the case of interferences between the coarse calculation done in current mode and the fine calculation done in velocity mode. Choosing too large a value increases the wake and shake duration.

Related Topics

Wake and Shake Overview (→ p. 58)

19.31.16 WS.TDELAY3

General Information	
Type	NV Parameter
Description	Sets the delay for wake and shake between loops in mode 0.
Units	ms
Range	0 to 2,000 ms
Default Value	100 ms
Data Type	U16
See Also	N/A
Start Version	M_01-01-00-102, M_01-02-00-000

Fieldbus	Index/Subindex	Object Start Version
EtherCAT COE and CANopen	3494h/3	M_01-00-00-000

Description

WS.TDELAY3 defines the delay between complete loops in mode 0 only. Decreasing this value makes the wake and shake procedure faster, but may lead to problems if the motor moves too long. Increasing this value will make wake and shake significantly longer.

Related Topics

Wake and Shake Overview (→ p. 58)

19.31.17 WS.TDELAY4

General Information	
Type	NV Parameter
Description	Sets the delay time after first current-pulse injection.
Units	ms
Range	0 to 10,000 ms
Default Value	2000 ms
Data Type	U16
Start Version	M_01-01-00-102, M_01-02-00-000

Description

WS.TDELAY4 defines the delay time after first current-pulse injection.

Related Topics

Wake and Shake Overview (→ p. 58)

19.31.18 WS.TIRAMP

General Information	
Type	R/W Parameter
Description	Sets the ramp time for the ramp up current in Wake & Shake mode 1.
Units	ms
Range	512 to 10,000
Default Value	512
Data Type	U16
Start Version	M_01-06-07-000

Fieldbus	Index/Subindex	Object Start Version
EtherCAT COE and CANopen	535Dh/0	M_01-06-07-000

Description

In Wake & Shake mode 1, a maximum current of WS.IMAX is applied to the motor. WS.TIRAMP defines a time to reach this maximum current. Longer times are useful for big inertia motors or heavy loads.

Related Topics

Wake and Shake Overview (→ p. 58) | WS.MODE (→ p. 744) | WS.TSTANDSTILL (→ p. 753)

19.31.19 WS.TSTANDSTILL

General Information	
Type	R/W Parameter
Description	Sets the calming time of the motor for Wake & Shake mode 1.
Units	ms
Range	100 to 20,000
Default Value	1000
Data Type	U16
Start Version	M_01-06-07-000

Fieldbus	Index/Subindex	Object Start Version
EtherCAT COE and CANopen	535Ch/0	M_01-06-07-000

Description

In Wake & Shake mode 1, a maximum current of WS.IMAX is applied to the motor. WS.TSTANDSTILL defines a wait time, during which this maximum current is held, before detecting the commutation angle of the motor. Longer times are useful for big inertia motors or heavy loads.

Related Topics

Wake and Shake Overview (→ p. 58) | WS.MODE (→ p. 744) | WS.TIRAMP (→ p. 752)

19.31.20 WS.VTHRESH

General Information	
Type	NV Parameter
Description	Defines the maximum allowed velocity for Wake & Shake.
Units	Rotary: rpm, rps, deg/s, rad/s Linear: counts/s, mm/s, $\mu\text{m/s}$
Range	Rotary: 0.000 to 15,000.000 rpm 0.000 to 250.000 rps 0.000 to 90,000.000 degree/s 0.000 to 1,570.796 rad/s Linear: 0.000 to 1,073,741,824,000.000 counts/s 0.000 to 8,000.000 mm/s 0.000 to 8,000,000.000 $\mu\text{m/s}$
Default Value	100 rpm
Data Type	U16
See Also	N/A
Start Version	M_01-01-00-101, M_01-02-00-000

Fieldbus	Index/Subindex	Object Start Version
EtherCAT COE and CANopen	3494h/4	M_01-00-00-000

Description

This parameter defines the maximum allowed velocity that occurs while commutation finding is active. This supervision runs in real time, but only while wake and shake is active (WS.STATE 2 or greater, for Mode 0). If at any time while wake and shake is running a velocity higher than this value is detected, fault Fault and Warning Messages (→ p. 174) is generated. Setting WS.VTHRESH to zero disables this feature. For Mode 1, WS.VTHRESH is only used after the initial phase-finding.

Related Topics

Wake and Shake Overview (→ p. 58)

19.32 EtherCAT Profile

19.32.1 Slave Register

The table below gives the addresses of individual registers in the FPGA memory. The data is provided in little-endian format, with the 'least significant byte' occupying the lowest address. A detailed description of all registers and FPGA memory locations is available in the "EtherCAT Slave Controller" description of the EtherCAT user organization (www.EtherCAT.org).

Address	Length (Byte)	Description	ZA ECAT*	ZA Drive*
0x0120	2	AL Control	R/W	R/O
0x0130	2	AL Status	R/O	R/W
0x0134	2	AL Status Code	R/O	R/W
0x0204	2	Interrupt Enable Register	R/O	R/W
0x0220	2	AL Event (IRQ Event)	R/W	R/O
0x0800	8	Sync Manager 0 (Mail Out Control Register)	R/W	R/O
0x0808	8	Sync Manager 1 (Mail In Control Register)	R/W	R/O
0x0810	8	Sync Manager 2 (Process data Output Control Register)	R/W	R/O
0x0818	8	Sync Manager 3 (Process data Input Control Register)	R/W	R/O
0x0820	8	Sync Manager 4	R/W	R/O
0x0828	8	Sync Manager 5	R/W	R/O
0x0830	8	Sync Manager 6	R/W	R/O
0x0838	8	Sync Manager 7	R/W	R/O
0x0840	8	Sync Manager 8	R/W	R/O
0x1100	Max. 64	ProOut Buffer (Process data Output, set-points ECAT)	R/W	R/O
0x1140	Max. 64	ProIn (Process data Input, act. values ECAT)	R/O	R/W
0x1800	512	Mail Out Buffer (Object Channel Buffer ECAT, byte-length is specified in the device description file)	R/W	R/O
0x1C00	512	Mail In Buffer (Object Channel Buffer Drive, byte-length is specified in the device description file)	R/O	R/W

* ZA ECAT = Access mode EtherCAT

* ZA Drive = Access mode drive

19.32.2 AL Event (Interrupt Event) and Interrupt Enable

Communication between the drive and the EtherCAT FPGA can be interrupt-driven. The interrupt enable register and the AL event register are responsible for the EtherCAT interface interrupt functionality.

There are two events which lead also to a HW interrupt within the drive, the EEPROM emulation event and the SyncManager 2 event. The actual values of the drive (SyncManager 3 data) are written without any AL event request during each HW IRQ, e.g. triggered by a SyncManager 2 event. The Mailbox exchange between the master and the AKD PDMM is completely handled by polling the AL event register within the background task of the drive.

The drive activates individual EtherCAT interface events when the corresponding bit of the interrupt enable register is set to 1. When it is set to 0, the hardware interrupts for the specific events are deactivated.

19.32.2.1 Interrupt Enable Register (Address 0x0204:0x0205)

Parameter	Address	Bit	ZA Drive	ZA ECAT	Description
AL Control Event	0x204	0	R/W	R/O	Activation of AL control event for phase run-up
-	0x204	1	R/W	R/O	Reserved
Sync0 DC Distributed Clock	0x204	2	R/W	R/O	Activation of distributed clock (DC) sync 0 interrupts for entire communication
Sync1 DC Distributed Clock	0x204	3	R/W	R/O	Activation of distributed clock (DC) sync 1 interrupts for entire communication
SyncManager activation register change	0x204	4	R/W	R/O	Activation of 'SyncManager activation register change' IRQ.
EEPROM emulation event	0x204	5	R/W	R/O	Activation of the EEPROM emulation interrupts.
-	0x204	3 to 7	R/W	R/O	Reserved
Sync Manager 0 Event (Mail Out Event)	0x205	0	R/W	R/O	Activation of output event mailbox (SDO, Sync Manager 0) for object channel.
Sync Manager 1 Event (Mail In Event)	0x205	1	R/W	R/O	Activation of input event mailbox (SDO, Sync Manager 1) for object channel.
Sync Manager 2 Event (Pro Out Event)	0x205	2	R/W	R/O	Activation of output event process data (PDO, card's cyclical setpoints)
Sync Manager 3 Event (Pro In Event)	0x205	3	R/W	R/O	Activation of input event process data (PDO, drive's cyclical actual values)
-	0x205	4 to 7	R/W	R/O	Reserved

19.32.2.2 AL Event Request (Address 0x0220:0x0221)

When the relevant bit of the AL event request register is set to 1, the EtherCAT interface tells the drive which event it should process by the AKD PDMM.

Parameter	Address	Bit	ZA Drive	ZA ECAT	Description
AL Control Event	0x220	0	R/O	R/W	Processing of AL control event for phase run-up
Sync0 Distributed Clock (DC) Event	0x220	2	R/O	R/W	Processing of a distributed clock (DC) event
Sync1 Distributed Clock (DC) Event	0x220	3	R/O	R/W	Processing of a distributed clock (DC) event
SyncManager activation register change	0x220	4	R/O	R/W	The content of the SyncManager activation register has been changed.
EEPROM emulation event	0x220	5	R/O	R/W	Processing of an EEPROM emulation event in order to identify the AKD PDMM within the network.
-	0x220	6 to 7	R/O	R/W	Reserved
Sync Manager 0 Event	0x221	0	R/O	R/W	Mailbox request (SDO, Sync Manager 0) for object channel.
Sync Manager 1 Event	0x221	1	R/O	R/W	Mailbox response (SDO, Sync Manager 1) for object channel.
Sync Manager 2 Event	0x201	2	R/O	R/W	Process data output (PDO, card's cyclical setpoints)
Sync Manager 3 Event	0x201	3	R/O	R/W	Process data input (PDO, drive's cyclical actual values)
Sync Manager 4 –					
Sync Manager 7 Event	0x221	4 to 7	R/O	R/W	Reserved
Sync Manager 8 –					
Sync Manager 15 Event	0x222	0 to 7	R/O	R/W	Reserved

19.32.3 Phase Run-Up

The AL control, AL status and AL status code registers are responsible for communication phase run-up (also referred to as EtherCAT status change), for current status display and for any fault messages. The drive responds to every EtherCAT interface transition request made by the AL control register via the AL Status and AL Status Code registers. Any fault messages are displayed in the AL status code register.

A status change within the AL control register is polled within the AKD PDMM, which means that an AL control event does not lead to a HW interrupt within the drive.

19.32.3.1 AL Control (Address 0x0120:0x0121)

Parameter	Address	Bit	ZA Drive	ZA ECAT	Description
Status	0x120	3 to 0	R/O	W/O	0x01: Init Request
0x02: PreOperational Request					
0x03: Bootstrap Mode Request					
0x04: Safe Operational Request					
0x08: Operational Request					
Acknowledgement	0x120	4	R/O	W/O	0x00: No fault acknowledgement 0x01: Fault acknowledgement (positive edge)
Reserved	0x120	7 to 5	R/O	W/O	-
Applic. specific	0x120	15 to 8	R/O	W/O	-

19.32.3.2 AL Status (Address 0x0130:0x0131)

Parameter	Address	Bit	ZA Drive	ZA ECAT	Description
Status	0x130	3 to 0	W/O	R/O	0x01: Init
0x02: PreOperational					
0x03: Bootstrap Mode					
0x04: Safe Operational					
0x08: Operational					
Status change	0x130	4	W/O	R/O	0x00: Acknowledgement 0x01: Error, e.g. forbidden transition
Reserved	0x130	7 to 5	W/O	R/O	-
Applic. specific	0x130	15 to 8	W/O	R/O	-

19.32.3.3 AL Status Code (Address 0x0134:0x0135)

Parameter	Address	Bit	ZA Drive	ZA ECAT	Description
Status	0x134	7 to 0	W/O	R/O	See table below
Status	0x135	7 to 0	W/O	R/O	See table below
Code	Description	Current Status (Status change)		Resulting Status	
0x0000	No error	All		Current Status	
0x0011	Invalid requested state change	I -> S, I -> O, P -> O, O -> B, S -> B, P -> B		Current Status + E	
0x0017	Invalid sync manager configuration	I -> P, P -> S		Current Status + E	

No other codes are supported.

19.32.3.4 EtherCAT communication phases

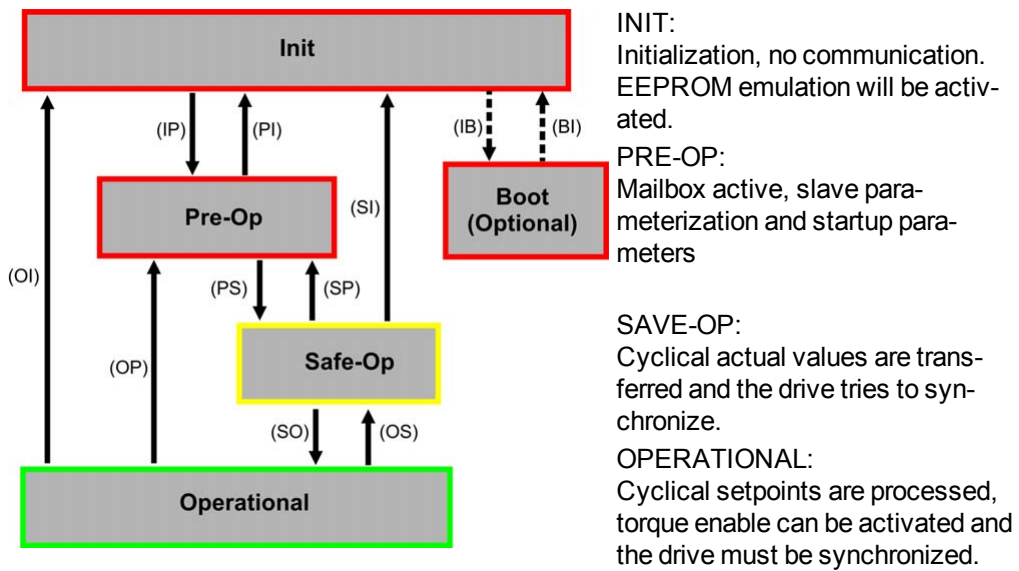

Individual communication transitions

Transition	AL Control (Bit 3 to 0)	Description
(IB)	0x03	-
(BI)	-	-
(IP)	0x02	AKD PDMM reads the SyncManager 0 & 1 configuration and verifies the value of the start-address and the length. The AKD PDMM prepares itself for handling SyncManager 0 events.
(PI)	0x01	-
(PS)	0x04	AKD PDMM reads the SyncManager 2 & 3 configuration and verifies the value of the start-address and the length.
(SP)	0x02	-
(SI)	0x01	-

Transition	AL Control (Bit 3 to 0)	Description
(SO)	0x08	The SsyncManager 2 hardware interrupt will be enabled by the drive.
(OS)	0x04	Deactivation of SsyncManager 2 hardware interrupt.
(OP)	0x02	Deactivation of SsyncManager 2 hardware interrupt..
(OI)	0x01	Deactivation of SsyncManager 2 hardware interrupt.

19.32.4 CANopen over EtherCAT (CoE) State Machine

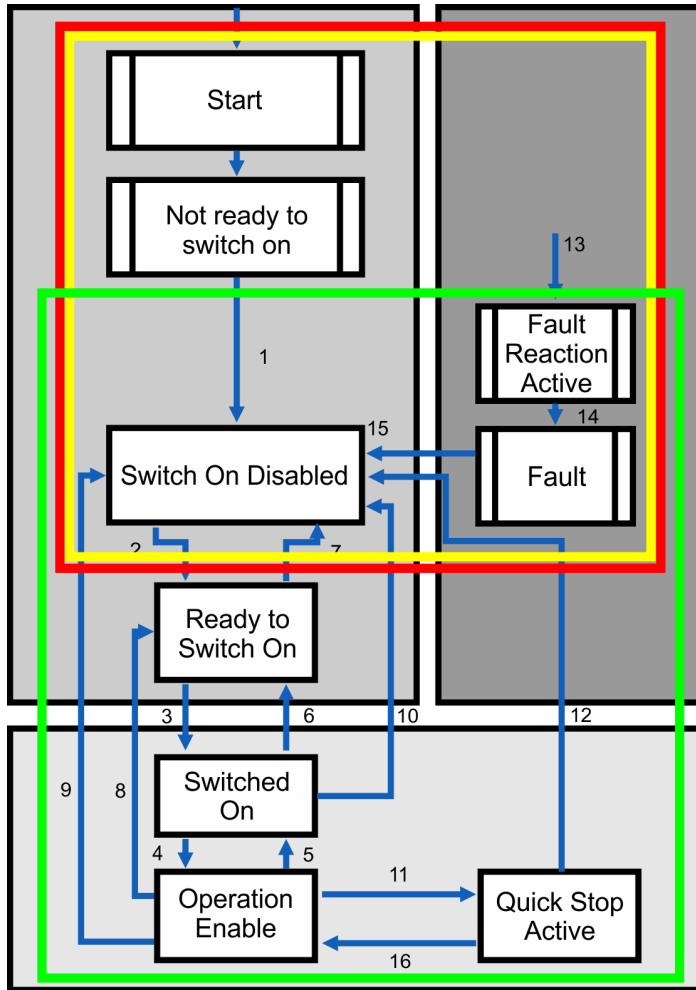

The state machine for the control and status words corresponds to the CANopen state machine in accordance with DS402.

CANopen control and status words are captured in every instance of fixed PDO mapping (see chapter "Fixed PDO Mappings" (→ p. 921)).

19.32.4.1 Status Description

Status	Description
Not Ready to Switch On	The drive is not ready to switch on; the controller has not indicated readiness for service. The drive is still in the boot phase or in fault status.
Switch On Disable	In 'Switch On Disable' status, the amplifier cannot be enabled via the EtherCAT interface, because (for example) there is no connection to a power source.
Ready to Switch On	In 'Ready to Switch On' status, the drive can be enabled via the control word.
Switched On	In 'Switched On' status, the amplifier is enabled, but the setpoints of the EtherCAT-interface are not yet transferred. The amplifier is idle, and a positive edge in bit 3 of the control word activates setpoint transfer (transition to 'Operation Enable' status).
Operation Enable	In this status, the drive is enabled and setpoints are transferred from the EtherCAT interface.
Quick Stop Active	The drive follows a quick stop ramp.

Status	Description
Fault Reaction Active	The drive responds to a fault with an emergency stop ramp.
Fault	A fault is pending, the drive is stopped and disabled.

19.32.4.2 Commands in the Control Word

Bit assignment in the control word

Bit	Name	Bit	Name
0	Switch on	8	Pause/halt
1	Disable Voltage	9	reserved
2	Quick Stop	10	reserved
3	Enable Operation	11	reserved
4	Operation mode specific	12	reserved
5	Operation mode specific	13	Manufacturer-specific
6	Operation mode specific	14	Manufacturer-specific
7	Reset Fault (only effective for faults)	15	Manufacturer-specific

Commands in the control word

Command	Bit 7 Fault Reset	Bit 3 Enable Operation	Bit 2 Quick Stop	Bit 1 Disable Voltage	Bit 0 Switch On	Transitions
Shutdown	X	X	1	1	0	2, 6, 8
Switch on	X	X	1	1	1	3
Disable Voltage	X	X	X	0	X	7, 9, 10, 12
Quick Stop	X	X	0	1	X	7, 10, 11
Disable Operation	X	0	1	1	1	5
Enable Operation	X	1	1	1	1	4, 16
Fault Reset	1	X	X	X	X	15

Bits labeled **X** are irrelevant. **0** and **1** indicate the status of individual bits.

Mode-dependent bits in the control word

The following table shows the mode-dependent bits in the control word. Only manufacturer-specific modes are supported at present. The individual modes are set by Object 6060h Modes of operation.

Operation mode	No	Bit 4	Bit 5	Bit 6
Profile Position Mode (pp)	01h	new_setpoint	change_set_immediately	absolute/relative
Profile Velocity Mode (pv)	03h	reserved	reserved	reserved
Profile Torque Mode (tq)	04h	reserved	reserved	reserved
Homing Mode (hm)	06h	homing_operation_start	reserved	reserved
Interpolated Position Mode (ip)	07h		reserved	reserved
Cyclic synchronous position mode	08h	reserved	reserved	reserved

Description of the remaining bits in the control word

Bit 8: (Pause) If Bit 8 is set, then the drive halts (pauses) in all modes. The setpoints (speed for homing or jogging, motion task number, setpoints for digital mode) for the individual modes are retained.

Bit 9,10: These bits are reserved for the drive profile (DS402).

Bit 13, 14, 15: These bits are manufacturer-specific, and reserved at present.

19.32.4.3 State Machine Bits (status word)

Bit assignment in the status word

Bit	Name	Bit	Name
0	Ready to switch on	8	Manufacturer-specific (reserved)
1	Switched on	9	Remote (always 1)
2	Operation enable	10	Target reached
3	Fault	11	Internal limit active
4	Voltage enabled	12	Operation mode specific (reserved)
5	Quick stop	13	Operation mode specific (reserved)
6	Switch on disabled	14	Manufacturer-specific (reserved)
7	Warning	15	Manufacturer-specific (reserved)

States of the state machine

State	Bit 6 switch on disable	Bit 5 quick stop	Bit 3 fault	Bit 2 operation enable	Bit 1 switched on	Bit 0 ready to switch on
Not ready to switch on	0	X	0	0	0	0
Switch on disabled	1	X	0	0	0	0
Ready to switch on	0	1	0	0	0	1
Switched on	0	1	0	0	1	1
Operation enabled	0	1	0	1	1	1
Fault	0	X	1	0	0	0
Fault reaction active	0	X	1	1	1	1
Quick stop active	0	0	0	1	1	1

Bits labeled **X** are irrelevant. **0** and **1** indicate the status of individual bits.

Description of the remaining bits in the status word

Bit 4: voltage_enabled The DC-link voltage is present if this bit is set.

Bit 7: warning There are several possible reasons for Bit 7 being set and this warning being produced. The reason for this warning can be revealed by using the Object 20subindex manufacturer warnings.

Bit 9: remote is always set to 1, i.e. the drive can always communicate and be influenced via the RS232 - interface.

Bit 10: target_reached This is set when the drive has reached the target position.

Bit 11: internal_limit_active This bit specifies that a movement was or is limited. In different modes, different warnings cause the bit to be set.

19.32.5 Fixed PDO Mappings

Various ready-to-use mappings can be selected for cyclic data exchange via SDO's of the object 0x1C12 and 0x1C13. Using object 0x1C12 subindex 1 (Sync Manager 2 assignment), a fixed mapping for the cyclic command values can be set with the values 0x1701, 0x1702, 0x1720 to 0x1724. Using object 0x1C13 subindex 1 (Sync Manager 3 assignment), a fixed mapping for the cyclic actual values can be set via the data 0x1B01, 0x1B20 to 0x1B25.

Use the sequence below to select the fixed command value mapping 0x1701 via SDO's:

1. SDO write access to object 0x1C12Sub0 Data:0x00
2. SDO write access to object 0x1C12Sub1 Data:0x1701
3. SDO write access to object 0x1C12Sub0 Data:0x01

NOTE

Up to firmware version 1.8.x.x AKD.XML file, fixed mapping 0x1701 called out 0x6062sub0 as the "Position Command". From AKD PDMM firmware release 1.8.5.0, the AKD.XML will be changed to call out 0x60C1sub1 as the "Position Command" and an additional XML file called "AKD_TwinCAT.XML" will be added to support TwinCat 2x and older. In reality, SDO 0x6062sub0 is not supported in the AKD PDMM firmware but was called in the fixed mapping to support a TwinCat issue.

Position interface, supported fixed mappings:

0x1701	Position command value (4 bytes), Control word (2 bytes), total (6 bytes)
0x1720	Control Word (2 bytes), Interpolated position command value (4 bytes), Latch control word (2 bytes), Torque feed forward (2 bytes), Digital outputs (2 bytes)
0x1721	Interpolated position command value (4 bytes), Control Word (2 bytes), Torque feed forward (2 bytes)
0x1722	Control word (2 byte), Interpolated position command value (4 bytes), Latch control word (2 bytes), Torque feed forward (2 bytes), Digital outputs (2 bytes), max. torque (2 bytes)
0x1723	Control word (2 bytes), Interpolated position command value (4 bytes), Latch control word (2 bytes), Torque feed forward (2 bytes), Digital outputs (2 bytes), Reset of changed input information (2 bytes)
0x1724	Target position for cyclic synchronous position mode (4 bytes), Control word (2 byte), Torque feed forward (2 bytes)
0x1B01	Position actual value (4 bytes), Status word (2 bytes), total (6 bytes)
0x1B20	Position actual internal value (4 bytes), 2nd position feedback position (4 bytes), velocity actual value (4 bytes), digital inputs (4 bytes), following error (4 bytes), latch position positive (4 bytes), status word (2 bytes), torque actual value (2 bytes), latch status (2 bytes), analogue input value (2 bytes)
0x1B21	Position Actual Internal Value (4 bytes), Status word (2 bytes)
0x1B22	Position actual internal value (4 bytes), 2nd position feedback position (4 bytes), velocity actual value (4 bytes), digital inputs (4 bytes), following error (4 bytes), latch position negative (4 bytes), status word (2 bytes), torque actual value (2 bytes), latch status (2 bytes), analogue input value (2 bytes)
0x1B23	Position actual internal value (4 bytes), 2nd position feedback position (4 bytes), velocity actual value (4 bytes), digital inputs (4 bytes), following error (4 bytes), latch position positive / negative (4 bytes), status word (2 bytes), torque actual value (2 bytes), latch status (2 bytes), analogue input value (2 bytes)
0x1B24	Position actual value (4 bytes), status word (2 bytes)

0x1B25	Position actual internal value (4 bytes), 2nd position feedback position (4 bytes), latch position 2 positive / negative (4 bytes), digital inputs (4 bytes), following error (4 bytes), latch position 1 positive / negative (4 bytes), status word (2 bytes), torque actual value (2 bytes), latch status (2 bytes), analogue input value (2 bytes)
--------	---

Velocity interface, supported fixed mappings:

0x1702	Velocity command value (4 bytes), Control word (2 bytes), total (6 bytes)
--------	---

The objects, which are mapped into the fixed PDOs can be read via the subindices 1 to n of the above indices. The number of mapped entries is available by reading subindex 0 of the above indices.

Example:

A read access to object 1702 sub 0 gives a value of 2, a read on subindex 1 gives 0x60ff0020, on subindex 2 0x60400010. The meaning of these numbers can be seen in the CANopen manual or the flexible-mapping example (→ p. 926.).

19.32.6 Flexible PDO Mappings

In addition to the fixed PDO mapping the so-called flexible mapping of real-time objects is possible.

NOTE

Available objects for PDO mapping are listed in the object dictionaries ("Appendix" (→ p. 945))("Appendix" (→ p. 1)). All objects with the entry "yes" in column "PDO map." can be used.

Restrictions of flexible mapping:

- An odd length PDO is not allowed.
- In the Rx(=set-point)-direction the dummy-object 0x0002 sub 0 with a length of 8 bits can be used to make the PDO-length even.
- In the Tx(=actual value)-direction one sub-index of the manufacturer status object 0x2002 sub 1..4 can be used to guarantee the even length of the Tx-PDO.
- These special mappings may be used if the objects 0x6060 and 0x6061 have to be used in the mapping.
- The allowed PDOs have up to 32 bytes (Tx) or 22 bytes (Rx). They are built from smaller PDO modules with a maximum length of 8 bytes. These are built by using the mapping objects 0x1600 to 0x1603 and 0x1a00 to 0x1a03.

The configuration is similar to the described sequence for the fixed mappings:

1. The mapping selection is cleared (write 0 to object 0x1C12 sub 0 and 1C13 sub 0)
2. As the AKD PDMM - implementation is based on CANopen the real-time data are build from up to 4 PDOs with 8 bytes in both directions. These PDOs are built in the same way as in a CAN-drive with the objects 0x1600 - 0x1603 and 0x1A00 - 0x1A03. Unused PDOs must be cleared with writing 0 to the subindex 0.
3. SDO write access to object 0x1C12 sub 1 .. 4 with the PDOs (0x1600 .. 0x1603), that should be used in receive direction of the AKD PDMM (set point values).
4. SDO write access to object 0x1C13 sub 1 .. 4 with the PDOs (0x1A00 .. 0x1A03), that should be used in transmit direction of the AKD PDMM (actual values).
5. SDO write access to the objects 0x1C12 sub 0 and 0x1C13 sub 0 with the number of mapped PDOs in this direction.

See an example in chapter "Flexible PDO Mappings" (→ p. 769) .

The cyclically used data are visible in the PDO-assignment window for the Inputs and Outputs of the Sync Managers. Default setting are the fixed PDOs 0x1701 and 0x1B01 (visible contents when selected in the PDO list).

The screenshot displays the configuration interface for the AKD PDMM. On the left, a tree view shows the system configuration, including NC-Task 1 SAF, PLC-Configuration, and I/O-Configuration. The main window is titled 'Process Data' and contains the following sections:

- Sync Manager:** A table with columns SM, Size, Type, and Flags. It lists 4 entries: SM 0 (512, MbxOut), SM 1 (512, MbxIn), SM 2 (6, Outputs), and SM 3 (6, Inputs).
- PDO List:** A table with columns Index, Size, Name, Flags, SM, and SU. It lists 16 entries, including 0x1A00 (2.0, Inputs), 0x1A01 (0.0, Inputs), 0x1A02 (0.0, Inputs), 0x1A03 (0.0, Inputs), 0x1B01 (6.0, Inputs), 0x1B20 (32.0, Inputs), 0x1B21 (6.0, Inputs), 0x1B22 (32.0, Inputs), 0x1B23 (32.0, Inputs), 0x1B24 (6.0, Inputs), and 0x1600 (2.0, Outputs).
- PDO Assignment (0x1C12):** A list of checkboxes for PDOs 0x1600 through 0x1703. 0x1701 is checked, while others are excluded by 0x1701.
- PDO Content (0x1A00):** A table with columns Index, Size, Offs, Name, Type, and Default (hex). It shows 2 entries for 0x6041:00 (2.0, 0.0, Status word, UINT, 2.0).

At the bottom, there are buttons for 'Download', 'PDO Assignment' (checked), and 'PDO Configuration'.

If the flexible mapping is required, the PDO configuration check box must be changed.

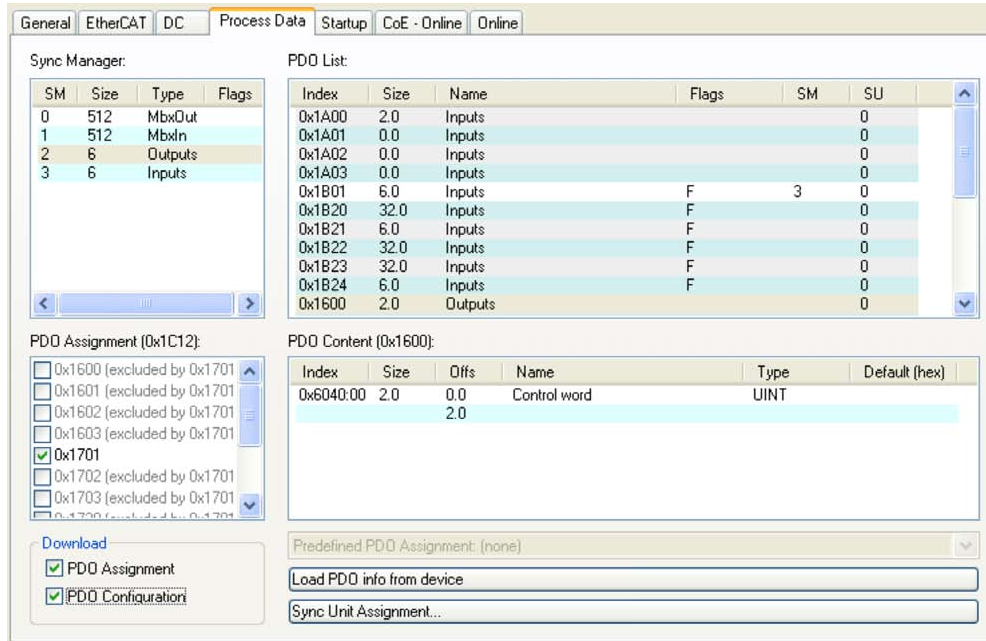

19.32.6.1 Example: Flexible PDO Mapping

For the flexible mapping of the Outputs the fixed mapping 0x1701 has to be switched off and up to 4 free-mappable PDOs (0x1600-0x1603) can be used instead. The maximum number of bytes for each of these PDOs is 8.

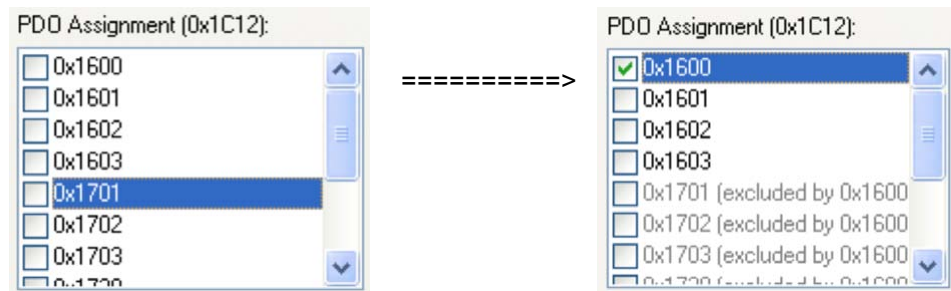

After that the default mapping of e.g. the PDO 0x1600 can be extended:

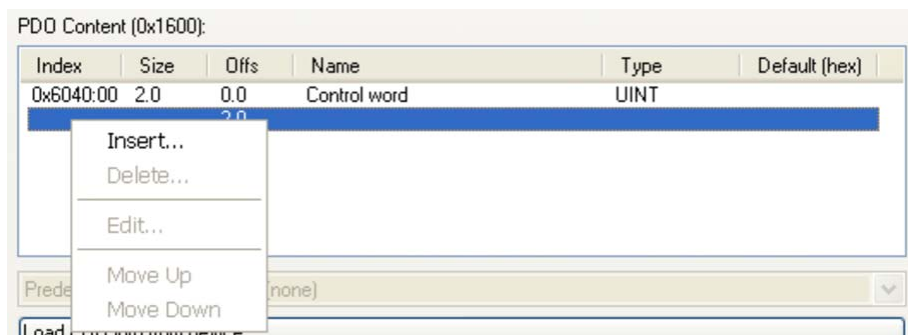

A list of possible objects for the mapping will be shown and a new entry can be chosen.

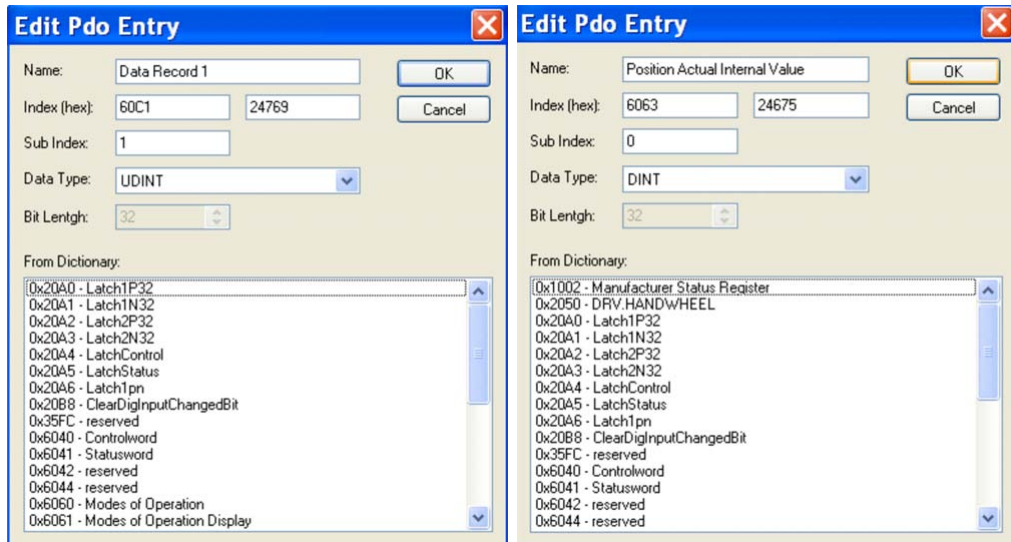

In this case the setpoint for the interpolated position mode is selected.

The same is valid for the Tx-PDO-direction. Here the value of the actual internal position is selected.

This results in the startup-SDO-list for this sample free-mapped-configuration.

Transition	Protocol	Index	Data	Comment
<PS>	CoE	0x1C12:00	0x00 (0)	clear sm pdos (0x1C12)
<PS>	CoE	0x1C13:00	0x00 (0)	clear sm pdos (0x1C13)
<PS>	CoE	0x1A00:00	0x00 (0)	clear pdo 0x1A00 entries
<PS>	CoE	0x1A00:01	0x60410010 (1614872592)	download pdo 0x1A00 entry
<PS>	CoE	0x1A00:02	0x60630020 (1617100832)	download pdo 0x1A00 entry
<PS>	CoE	0x1A00:00	0x02 (2)	download pdo 0x1A00 entr...
<PS>	CoE	0x1A01:00	0x00 (0)	clear pdo 0x1A01 entries
<PS>	CoE	0x1A02:00	0x00 (0)	clear pdo 0x1A02 entries
<PS>	CoE	0x1A03:00	0x00 (0)	clear pdo 0x1A03 entries
<PS>	CoE	0x1600:00	0x00 (0)	clear pdo 0x1600 entries
<PS>	CoE	0x1600:01	0x60400010 (1614807056)	download pdo 0x1600 entry
<PS>	CoE	0x1600:02	0x60C10120 (1623261472)	download pdo 0x1600 entry
<PS>	CoE	0x1600:00	0x02 (2)	download pdo 0x1600 entr...
<PS>	CoE	0x1601:00	0x00 (0)	clear pdo 0x1601 entries
<PS>	CoE	0x1602:00	0x00 (0)	clear pdo 0x1602 entries
<PS>	CoE	0x1603:00	0x00 (0)	clear pdo 0x1603 entries
<PS>	CoE	0x1C12:01	0x1600 (5632)	download pdo 0x1C12:01 i...
<PS>	CoE	0x1C12:00	0x01 (1)	download pdo 0x1C12 count
<PS>	CoE	0x1C13:01	0x1B01 (6913)	download pdo 0x1C13:01 i...
<PS>	CoE	0x1C13:00	0x01 (1)	download pdo 0x1C13 count
PS	CoE	0x6060:00	0x07 (7)	Opmode
PS	CoE	0x60C2:01	0x02 (2)	Cycle time
PS	CoE	0x60C2:02	0xFD (253)	Cycle exp

The meaning of the data (for example 0x60410010 in the mapping of 0x1A00 sub 1) is as follows:

- 0x6041 is the index of the DS402 status word
- 0x00 is the subindex of the DS402 status word
- 0x10 is the number of bits for this entry, i. e. 16 bits or 2 bytes.

If this shall be used in the NC, the interpolation set point position has to be linked from the axis to the NC-axis.

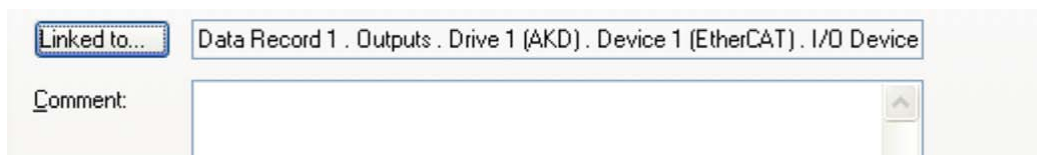
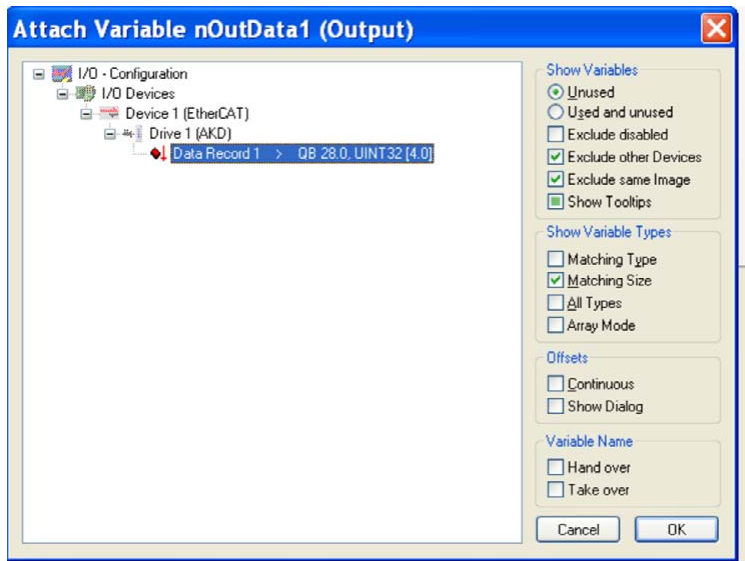
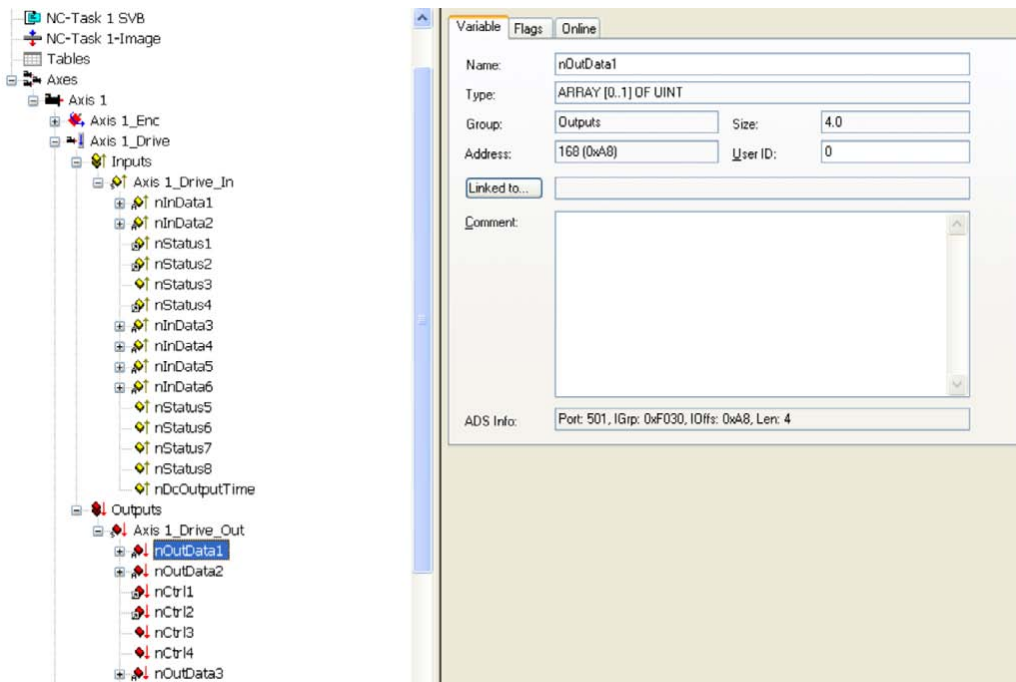

After doing this configuration the mapping can be activated as seen before in this document:

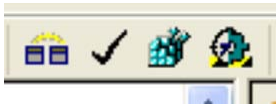

Now the NC-screen should show a position in the online window, which changes a bit in the last digits.

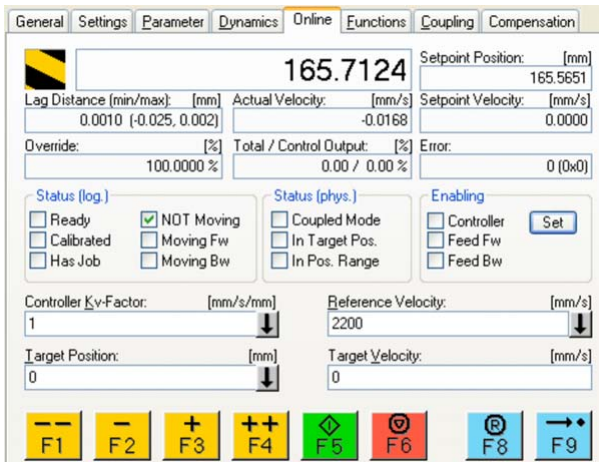

After enabling the power stage with the All-button, the drive can be moved via the jog-buttons or via the functions in the function menu.

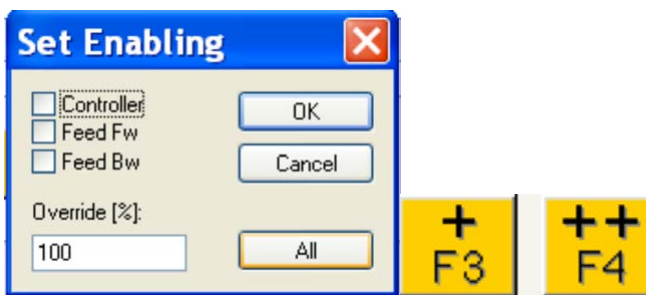

19.32.7 Supported Cyclical Setpoint and Actual Values

Supported cyclical setpoint values

Name	CANopen object	Data type	Description
Target current	0x2071 sub 0	32 bit	scaled in mA
Latch Control word	0x20A4 sub 0	UINT16	
Clear digital Input Change Bit	0x20B8	16 bit	
Analog output value	0x3470 sub 3	16 bit	
External feedback position	0x3497 sub 0	32 bit	
CANopen control-word	0x6040 sub 0	UINT16	CANopen control word.
Modes of Operation	0x6060 sub 0	8 bit	DS402 opmode setpoint
Velocity Window	0x606D sub 0	16 bit	
Velocity Window Time	0x606E sub 0	16 bit	
Target Torque	0x6071 sub 0	16 bit	0.1% resolution
Maximum Torque	0x6072 sub 0	16 bit	
Target position	0x607A sub 0	INT32	Used in profile position mode / cyclic synchronous position mode
Profile position target velocity	0x6081 sub 0	32 bit	related to MT.V
Profile position target acc	0x6083 sub 0	32 bit	related to MT.ACC
Profile position target dec	0x6084 sub 0	32 bit	related to MT.DEC
Velocity feed forward	0x60B1 sub 0	32 bit	
Torque feed forward	0x60B2 sub 0	INT16	
Touch probe function	0x60B8	16 bit	
Position command value	0x60C1 sub 1	INT32	Interpolation data record in IP-mode
Digital outputs	0x60FE sub 1	UINT32	
Velocity command value	0x60FF sub 0	INT32	

Supported cyclical actual values

Name	CANopen object	Data type	Description
Position actual internal value	0x6063 sub 0	INT32	
Velocity actual value	0x606C sub 0	INT32	
CANopen status-word	0x6041 sub 0	UINT16	CANopen status word
Second position feedback	0x2050 sub 0	INT32	
Digital inputs	0x60FD sub 0	UINT32	
Following error actual value	0x60F4 sub 0	INT32	
Latch position positive edge	0x20A0 sub 0	INT32	
Torque actual value	0x6077 sub 0	INT16	
Latch status	0x20A5 sub 0	UINT16	
Analog input value	0x3470 sub 0	INT16	
Actual Current	0x2077 sub 0	32 bit	scaled in mA
Latch1 negative edge	0x20A1 sub 0	32 bit	
Latch2 Positive	0x20A2 sub 0	32 bit	
Latch2 Negative	0x20A3 sub 0	32 bit	
Latch1 positive/negative edge	0x20A6	32 bit	
Latch 2 positive/negative edge	0x20A7	32 bit	
Modes of Operation	0x6061	8 bit	DS402 opmode status
Position Actual Value	0x6064 sub 0	32 bit	WB/ DS402 scale units
Touch probe status	0x60B9 sub 0	16 bit	
Touch probe 1 positive edge pos	0x60BA sub 0	32 bit	
Touch probe 1 negative edge pos	0x60BB sub 0	32 bit	
Touch probe 2 positive edge pos	0x60BC sub 0	32 bit	
Touch probe 2 negative edge pos	0x60BD sub 0	32 bit	
Additional Pos actual value	0x60E4 sub 0	48 bit	
Additional Pos actual value	0x60E4 sub 1	32 bit	
Motor I2t	0x3427 sub 3	32 bit	
Analog output value	0x3470 sub 2	16 bit	
Analog Input & Output value	0x3470 sub 4	16 bit	
Manufacturer status register	0x1002 sub 0	32 bit	

19.32.8 Supported Operation Modes

CANopen mode of operation	AKD PDMM mode of operation	Description
Profile velocity	DRV.OPMODE 1 DRV.CMDSOURCE 1	0x6060Sub0 Data: 3 In this mode, the EtherCAT master sends cyclic velocity command values to the AKD PDMM.
Interpolated position	DRV.OPMODE 2 DRV.CMDSOURCE 1	0x6060Sub0 Data: 7 In this mode of operation the EtherCAT master sends cyclic position command values to the AKD PDMM. These command values are interpolated by the AKD PDMM according to the fieldbus sample rate.
Homing mode	DRV.OPMODE 2 DRV.CMDSOURCE 0	0x6060 sub 0 data : 6 In this mode an AKD PDMM-internal homing can be done.
Profile Position	DRV.OPMODE 2 DRV.CMDSOURCE 0	0x6060sub0 Data: 1 Uses motion task 0 to execute a point to point move
Torque	DRV.OPMODE 0 DRV.CMDSOURCE 1	0x6060sub0 Data: 4 Commands torque in % of drive peak torque
Cyclic Synchronous Position	DRV.OPMODE 2 DRV.CMDSOURCE 1	0x6060sub0 Data: 8 Master calculates move profile and commands motion with position points

19.32.9 Adjusting EtherCAT Cycle Time

The cycle time to be used in the drive for the cyclical setpoints and actual values can either be stored in the FBUS.SAMPLEPERIOD parameter in the amplifier or configured in the startup phase. This happens via SDO mailbox access to objects 60C2 subindex 1 and 2.

Subindex 2, known as the interpolation time index, defines the power of ten of the time value (e.g. -3 means 10⁻³ or milliseconds) while subindex 1, known as interpolation time units, gives the number of units (e.g. 4 means 4 units).

You can run a 2 ms cycle using various combinations. For example,

Index = -3, Units = 2 or

Index = -4, Units = 20 etc.

The FBUS.SAMPLEPERIOD parameter is counted in multiples of 62.5us microseconds within the device. This means, for example that 2 ms equates to FBUS.SAMPLEPERIOD value of 32.

19.32.10 Maximum Cycle Times depending on operation mode

The minimum cycle time for the drive is largely dependent on the drive configuration (second actual position value encoder latch functionality enabled and so on)

Interface	Cycle time AKD PDMM
Position	≥ 0.25 ms (≥ 250 μs)
Velocity	≥ 0.25 ms (≥ 250 μs)
Torque	≥ 0.25 ms (≥ 250 μs)

19.32.11 Synchronization

On all drives, the internal PLL is theoretically able to even out an average deviation of up to 4800 ppm in the cycle time provided by the master. The drive checks once per fieldbus cycle a counter within the drive internal FPGA, which is cleared by a Sync0 (Distributed clock) event. Depending of the counter value, the drive extends or decreases the 62.5 μ s MTS signal within the drive by a maximum of 300 ns.

The theoretical maximum allowed deviation can be calculated by using the following formula:

$$\max_{dev} = \frac{300[\text{ns}]}{62.5[\mu\text{s}]} \cdot 1,000,000 = 4800 [\text{ppm}]$$

The synchronization functionality within the drive can be enabled via setting bit 0 of the FBUS.PARAM02 parameter to high. Therefore FBUS.PARAM02 must be set to the value of 1. Furthermore the distributed clock functionality must be enabled by the EtherCAT master in order to activate cyclic Sync0 events.

19.32.11.1 Synchronization behavior with distributed clocks (DC) enabled

When the EtherCAT master enables distributed clocks, a distributed clock (DC) event is created in the AKD PDMM once per fieldbus cycle. An assigned 62.5 μ s real-time task in the AKD PDMM monitors the elapsed time between the DC events and the AKD PDMM System time and extends or reduces the 62.5 μ s strobe to the CPU as necessary.

The following fieldbus parameters are used for the synchronization feature:

1. FBUS.SYNCDIST = Expected time delay of the AKD PDMM PLL-code to the DC event.
2. FBUS.SYNCACT = Actual time delay of the AKD PDMM PLL-code to the DC event.
3. FBUS.PLLTHRESH = Number of consecutive successful synchronized PLL cycles of the AKD PDMM before the Drive is considered as synchronized.
4. FBUS.SYNCWND = Synchronization window in which the AKD PDMM is considered to be synchronized. The Drive is considered synchronized as long as the following statement is true is true for FBUS.PLLTHRESH consecutive cycles:

$$\text{FBUS.SYNCDIST} - \text{FBUS.SYNCWND} < \text{FBUS.SYNCACT} < \text{FBUS.SYNCDIST} + \text{FBUS.SYNCWND}$$

Example with a 4kHz fieldbus sample rate:

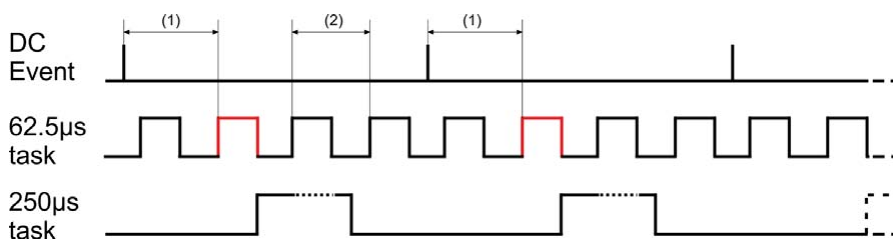

Explanation: The red-marked 62.5[μ s] real-time task displays the AKD PDMM 62.5 μ s real-time task within one fieldbus cycle which is responsible for calling the AKD PDMM PLL-code. The time delay (1) shows the actual delay to the previous DC event, which is ideally close to the adjusted FBUS.SYNCDIST parameter. Depending on (1) the AKD PDMM slightly extends or reduce the 62.5[μ s] IRQ generation of the high-priority real-time task in order to either increase or decrease the measured time delay to the DC event (1) for the next PLL cycle. The time distance (2) shows the 62.5[μ s] \pm x[ms] realtime task of the AKD PDMM.

19.32.11.2 Synchronization behavior with distributed clocks (DC) disabled

The AKD PDMM fieldbus synchronization algorithm is similar to that used by Distributed Clocks. The difference is that the AKD PDMM synchronizes to a SyncManager2 event instead of the DC event. A SyncManager2 event is created when the EtherCAT Master sends a new package of command values to the drive while the network is in the Operational state. This occurs once per fieldbus cycle.

19.32.12 Latch Control Word and Latch Status Word**Latch Control word (2 Byte)**

Bit	Value (bin)	Value (hex)	Description
0	00000000 00000001	zz01	Enable extern latch 1 (positive rise)
1	00000000 00000010	zz02	Enable extern latch 1 (negative rise)
2	00000000 00000100	zz04	Enable extern latch 2 (positive rise)
3	00000000 00001000	zz08	Enable extern latch 2 (negative rise)
4			
5-7			Reserve
8-12	00000001 00000000	01zz	Read external latch 1 (positive rise)
	00000010 00000000	02zz	Read external latch 1 (negative rise)
	00000011 00000000	03zz	Read external latch 2 (positive rise)
	00000100 00000000	04zz	Read external latch 2 (negative rise)
13-15			Reserve

Latch Status word (2 Byte)

Bit	Value (bin)	Value (hex)	Description
0	00000000 00000001	zz01	External latch 1 valid (positive rise)
1	00000000 00000010	zz02	External latch 1 valid (negative rise)
2	00000000 00000100	zz04	External latch 2 valid (positive rise)
3	00000000 00001000	zz08	External latch 2 valid (negative rise)
4			
5-7			Reserve
8-11	00000001 00000000	z1zz	Acknowledge value external latch 1 (positive rise)
	00000010 00000000	z2zz	Acknowledge value external latch 1 (negative rise)
	00000011 00000000	z3zz	Acknowledge value external latch 2 (positive rise)
	00000100 00000000	z4zz	Acknowledge value external latch 2 (negative rise)
12-15	00010000 00000000	1zzz	Zustand Digital Input 4
	00100000 00000000	2zzz	Zustand Digital Input 3
	01000000 00000000	4zzz	Zustand Digital Input 2

Bit	Value (bin)	Value (hex)	Description
	10000000 00000000	8zzz	Zustand Digital Input 1

19.32.13 Mailbox Handling

With EtherCAT, acyclical data traffic (object channel or SDO channel) is called mailbox.

NOTE

Available SDO objects are listed in the ("Appendix" (→ p. 945))("Appendix" (→ p. 1)).

This system is based around the master:

Mailbox Output:

The master (EtherCAT controller) sends data to the slave (drive). This is essentially a (read/write) request from the master. Mailbox output operates via Sync Manager 0.

Mailbox Input:

The slave (drive) sends data to the master (EtherCAT controller). The master reads the slave's response. Mailbox input operates via Sync Manager 1.

Timing diagram

The timing diagram illustrates the mailbox access process:



1. The EtherCAT master writes the mailbox request to the mail-out buffer.
2. On the next interrupt, the EtherCAT interface activates a Sync Manager 0 event (mailbox output event) in the AL event register.
3. The drive reads 16 bytes from the mail-out buffer and copies them to the internal mailbox output array.
4. The drive identifies new data in the internal mailbox output array and performs an SDO access to the object requested by the EtherCAT interface. The response from the drive is written to an internal mailbox input array.
5. The drive deletes all data in the internal mailbox output array so that a new mailbox access attempt can be made.
6. The drive copies the response telegram from the internal mailbox input array to the mail-in buffer of the EtherCAT interface.

19.32.13.1 Mailbox Output

An interrupt by the EtherCAT-interface with a Sync Manager 0 - Event starts a Mailbox Output Process. A 1 in the Mail Out Event-Bit of the AL Event register signalizes the drive, that the EtherCAT-interface wants to send a Mailbox message and that it has already stored the required data in the Mail Out Buffer. Now 16 Byte data are read by the drive with the IRQ process. The bytes are defined as follows

Address 0x1800								Address 0x180F							
0	1	2	3	4	5	6	7	8	9	10	11	12	13	14	15
CAN over EtherCAT specific data (CoE Header)								CAN specific data (standard CAN SDO)							
Byte 0	Length of the data (Low Byte)														
Byte 1	Length of the data (High Byte)														
Byte 2	Address (Low Byte)														
Byte 3	Address (High Byte)														
Byte 4	Bit 0 to 5: Channel Bit 6 to 7: Priority														
Byte 5	Bit 0 to 3: Type							1 = Reserved: ADS over EtherCAT 2 = Reserved: Ethernet over EtherCAT 3 = Can over EtherCAT...)							
	Bit 4 to 7: Reserved														
Byte 6	PDO Number (with PDO transmissions only, Bit 0 = LSB of the PDO number, see Byte 7 for MSB)														
Byte 7	Bit 0: MSB of the PDO number, see Byte 6														
	Bit 1 to 3: Reserved														
	Bit 4 to 7: CoE specific type							0: Reserved							
								1: Emergency message							
								2: SDO request							
								3: SDO answer							
								4: TXPDO							
								5: RxPDO							
								6: Remote transmission request of a TxPDO							
								7: Remote transmission request of a RxPDO							
							8...15: reserved								
Byte 8	Control-Byte in the CAN telegram:														
	write access:							0x23=4Byte, 0x27=3Byte, 0x2B=2Byte, 0x2F-F=1Byte							
	read access:							0x40							
Byte 9	Low Byte of the CAN object number (Index)														
Byte 10	High Byte of the CAN object number (Index)														
Byte 11	Subindex according to CANopen Specification for the drive														
Byte 12	Data with a write access (Low Byte)														
Byte 13	Data with a write access														
Byte 14	Data with a write access														

Byte 15	Data with a write access (High Byte)
---------	--------------------------------------

The drive answers every telegram with an answer in the Mailbox Input buffer.

19.32.13.2 Mailbox Input

The drive answers every CoE telegram with a 16 byte answer telegram in the Mailbox Input buffer. The bytes are defined as follows:

Address 0x1C00								Address 0x1C0F								
0	1	2	3	4	5	6	7	8	9	10	11	12	13	14	15	
CAN over EtherCAT specific data (CoE Header)								CAN specific data (standard CAN SDO)								
Byte 0	Length of the data (Low Byte)															
Byte 1	Length of the data (High Byte)															
Byte 2	Address (Low Byte)															
Byte 3	Address (High Byte)															
Byte 4	Bit 0 to 5: Channel Bit 6 to 7: Priority															
Byte 5	Bit 0 to 3: Type							1 = Reserved: ADS over EtherCAT 2 = Reserved: Ethernet over EtherCAT 3 = Can over EtherCAT...)								
	Bit 4 to 7: Reserved															
Byte 6	PDO Number (with PDO transmissions only, Bit 0 = LSB of the PDO number, see Byte 7 for MSB)															
Byte 7	Bit 0: MSB of the PDO number, see Byte 6															
	Bit 1 to 3: Reserved															
	Bit 4 to 7: CoE specific type							0: Reserved								
								1: Emergency message								
								2: SDO request								
								3: SDO answer								
								4: TXPDO								
								5: RxPDO								
								6: Remote transmission request of a TxPDO								
								7: Remote transmission request of a RxPDO								
Byte 8	Control-Byte in the CAN telegram:															
	write access OK:							0x60								
	read access OK + length of answer:							0x43 (4 Byte), 0x47 (3 Byte), 0x4B (2Byte), 0x4F (1Byte)								
	error with read- or write access:							0x80								
Byte 9	Low Byte of the CAN object number (Index)															
Byte 10	High Byte of the CAN object number (Index)															
Byte 11	Subindex according to CANopen Specification for Kollmorgen drive															
Byte 12	Data (Low Byte)															

Byte 13	Data	error code Fehlercode according to CANopen Specification in case of an error
Byte 14	Data	data value of the object in case of successful read access
Byte 15	Data (High Byte)	

19.32.13.3 Example: Mailbox Access

In the example below, PDOs 0x1704 are mapped (see Chapter "Fixed PDO Mappings" (→ p. 921) "Fixed PDO Mappings"):

The master sends this mailbox output message:

Byte 0	0x0A	The next 10 Bytes contain data (Byte 2 to Byte 11)
Byte 1	0x00	The next 10 Bytes contain data (Byte 2 to Byte 11)
Byte 2	0x00	Address 0
Byte 3	0x00	Address 0
Byte 4	0x00	Channel 0 and Priority 0
Byte 5	0x03	CoE Object
Byte 6	0x00	PDO Number 0
Byte 7	0x20	PDO Number 0 and SDO-Request
Byte 8	0x2B	2 Byte write access
Byte 9	0x12	SDO-Object 0x1C12
Byte 10	0x1C	SDO-Object 0x1C12
Byte 11	0x01	Subindex 1
Byte 12	0x04	Data value 0x00001704
Byte 13	0x17	Data value 0x00001704
Byte 14	0x00	Data value 0x00001704
Byte 15	0x00	Data value 0x00001704

The drive returns the following message:

Byte 0	0x0E	The next 14 Bytes contain data (Byte 2 to Byte 15)
Byte 1	0x00	The next 14 Bytes contain data (Byte 2 to Byte 15)
Byte 2	0x00	Address 0
Byte 3	0x00	Address 0
Byte 4	0x00	Channel 0 and Priority 0
Byte 5	0x03	CoE Object
Byte 6	0x00	PDO Number 0
Byte 7	0x20	PDO Number 0 and SDO-Answer
Byte 8	0x60	Successful write access
Byte 9	0x12	SDO-Object 0x1C12
Byte 10	0x1C	SDO-Object 0x1C12
Byte 11	0x01	Subindex 1
Byte 12	0x00	Data value 0x00000000
Byte 13	0x00	Data value 0x00000000
Byte 14	0x00	Data value 0x00000000
Byte 15	0x00	Data value 0x00000000

19.32.14 Fieldbus Parameters

The AKD PDMM holds several fieldbus-specific, general purpose parameters. Some of them contain the following EtherCAT relevant data:

FBUS.PARAM02:

This parameter activates the synchronization feature of the AKD PDMM. The DC feature must be activated in order to allow the AKD PDMM to get synchronized with the master. A value of 1 enables the drive internal PLL functionality, a value of 0 deactivates this feature.

FBUS.PARAM03:

This parameter contains the Configured Station Alias address of the AKD PDMM. An EEPROM emulation write access to the Configured Station Alias address forces the AKD PDMM to store the drive parameters automatically using the DRV.NVSAVE command.

FBUS.PARAM04:

This parameter enables (1) or disables(0) the synchronization supervision of the CANOpen or EtherCAT fieldbus.

Default values for this parameter are as follows:

CANopen drive: disabled (0)

EtherCAT drive: enabled (1)

Synchronization supervision is active when FBUS.PARAM 04 = 1 and the first CANOpen Sync message or first EtherCAT frame is received. When more than three CANOpen sync messages or seven EtherCAT frames have not been received and the drive is enabled, fault F125 ("Synchronization lost"), occurs.

FBUS.PARAM05

Bit 0	1	Faults can only be reset using DS402 control word bit 7.
	0	The reset can also be done via telnet or digital input and the DS402 state machine reflects this condition.
Bit 1	1	The state of the hardware enable does not change the state machine state Operation Enable.
	0	If the state Operation Enable or Switched on is active it falls back to the state switched On Disabled, if the Hardware enable goes to 0.
Bit 2	1	EWV ¹ /Telnet can not software enable the drive, when CANopen/EtherCAT are Operational.
	0	EWV/Telnet can software enable the drive. NOTE: During commissioning this bit should be set to 1 to avoid influences to DS402 power stage state machine. The field bus should not be in operation as well to avoid influence to test functions of Workbench.
Bit 3	1	DS402-state machine is not influenced, if the software-enable is taken away via Telnet.
	0	DS402-state machine is influenced, if the software-enable is taken away via Telnet.
Bit 4	1	Scaling is done via special DS402 - objects (independent on units)
	0	Scaling for position, velocity and acceleration objects is done via UNIT parameters.

¹Embedded Workbench Views

Bit 5	1	FBUS.PARAM03 defines the station alias address if not 0. If FBUS.PARAM03 set to 0, the address will be taken from rotary switches instead, if they are not 0. The EtherCAT master has the ability to use the alias address, selected by the drive, or issue its own.
	0	The rotary switches define the station alias address if not 0. If the rotary switches are set to 0, the address will be taken from FBUS.PARAM03 instead, if it is not 0.
Bit 6	1	Bit 0 of parameter MT.CNTL (object 35B9 sub 0) can be accessed.
	0	Bit 0 of parameter MT.CNTL (object 35B9 sub 0) is exclusively used for DS402 controlword.
Bit 7		reserved
Bit 8	1	DS402-state SWITCHED ON means power stage disabled.
	0	DS402-state SWITCHED ON means power stage enabled.
Bit 9	1	SDO content of object 0x6063 is the same as PDO content.
	0	SDO content of object 0x6063 depends on AKD PDMM unit parameters.
Bit 10 (Bit 10 is active only, if Bit 8 is set)	1	State "Switch On" can be reached without the high-level voltage being active.
	0	State "Switch On" can only be reached when the high-level voltage is active; otherwise the drive will stay in "Ready to Switch On".

19.32.15 EEPROM Content

AKD PDMM has a built-in emulated EEPROM. This EEPROM can be read by the EtherCAT master to get some information about drive properties, like PDO-information, drive name, serial numbers and communication-specific attributes.

They are organized in categories. There are two manufacturer-specific categories implemented in the AKD PDMM:

- Category 0x0800: Holds a string with the model type in the format AKD PDMM-P00000-NxxC-0000
- Category 0x0801: Holds the firmware version in the format 0x_xx-xx-yyy

This page intentionally left blank.

19.33 Appendix

19.33.1 CANopen Emergency Messages and Error Codes

Emergency messages are triggered by internal equipment errors. They have a high ID-priority to ensure quick access to the bus. An emergency message contains an error field with pre-defined error/fault numbers (2 bytes), an error register (1byte), the error category (1 byte), and additional information. Error numbers 0000h to 7FFFh are defined in the communication or drive profile. Error numbers FF00h to FFFFh have manufacturer-specific definitions.

Error Code	Fault/Warning	Description
0x0000	0	Emergency error free.
0x1080	-	General Warning.
0x1081	-	General Error.
0x3110	F523	DC Bus link over voltage FPGA.
0x3120	F247	DC Bus link voltage exceed allowed thresholds.
0x3130	F503	DC Bus link capacitor overload.
0x3180	n503	Warning: DC Bus link capacitor overload.
0x3210	F501	DC Bus link over-voltage.
0x3220	F502	DC Bus Link under-voltage.
0x3280	n502	Warning: DC Bus Link under-voltage.
0x3281	n521	Warning: Dynamic Braking I ² T.
0x3282	F519	Regen short circuit.
0x3283	n501	Warning: DC Bus link over-voltage.
0x4210	F234	Excessive temperature, device (control board).
0x4310	F235	Excessive temperature, drive (heat sink).
0x4380	F236	Power temperature sensor 2 high.
0x4381	F237	Power temperature sensor 3 high.
0x4382	F535	Power board overtemperature.
0x4390	n234	Warning: Control temperature sensor 1 high.
0x4391	n235	Warning: Power temperature sensor 1 high.
0x4392	n236	Warning: Power temperature sensor 2 high.
0x4393	n237	Warning: Power temperature sensor 3 high.
0x4394	n240	Warning: Control temperature sensor 1 low.
0x4395	n241	Warning: Power temperature sensor 1 low.
0x4396	n242	Warning: Power temperature sensor 2 low.
0x4397	n243	Warning: Control temperature sensor 1 low.
0x4398	F240	Control temperature sensor 1 low.
0x4399	F241	Power temperature sensor 1 low.
0x439A	F242	Power temperature sensor 2 low.
0x439B	F243	Power temperature sensor 3 low.

Error Code	Fault/Warning	Description
0x5113	F512	5V0 under voltage.
0x5114	F505	1V2 under voltage.
0x5115	F507	2V5 under voltage.
0x5116	F509	3V3 under voltage.
0x5117	F514	+12V0 under voltage.
0x5118	F516	-12V0 under voltage.
0x5119	F518	Analog 3V3 under voltage.
0x5180	F504	1V2 over voltage.
0x5181	F506	2V5 over voltage.
0x5182	F508	3V3 over voltage.
0x5183	F510	5V0 over voltage.
0x5184	F513	+12V0 over voltage.
0x5185	F515	-12V0 over voltage.
0x5186	F517	Analog 3V3 over voltage.
0x5530	F105	Hardware memory, non-volatile memory stamp invalid.
0x5580	F106	Hardware memory, non-volatile memory data.
0x5590	F204	Control board EEPROM read failed.
0x5591	F205	Control board EEPROM corrupted serial num stamp.
0x5592	F206	Control board EEPROM corrupted serial num data.
0x5593	F207	Control board EEPROM corrupted parameter stamp.
0x5594	F208	Control board EEPROM corrupted parameter data.
0x5595	F219	Control board EEPROM write failed.
0x55A0	F209	Power board EEPROM read failed.
0x55A1	F210	Power board EEPROM corrupted serial num stamp.
0x55A2	F212	Power board EEPROM corrupted serial num data.
0x55A3	F213	Power board EEPROM corrupted parameter stamp.
0x55A4	F214	Power board EEPROM corrupted parameter data.
0x55A5	F230	Power board EEPROM write failed.
0x55A6	F232	Power board EEPROM invalid data.
0x55B0	F248	Option board EEPROM corrupted.
0x55B1	F249	Option board upstream checksum.
0x55B2	F250	Option board upstream checksum.
0x55B3	F251	Option board watchdog.
0x55B8	F252	Firmware and option board FPGA types are not compatible.
0x55B9	F253	Firmware and option board FPGA versions are not compatible.
0x55C0	F621	Control Board CRC fault.
0x55C1	F623	Power Board CRC fault.
0x55C2	F624	Power Board Watchdog fault.

Error Code	Fault/Warning	Description
0x55C3	F625	Power Board Communication fault.
0x55C4	F626	Power Board FPGA not configured.
0x55C5	F627	Control Board Watchdog fault.
0x55C6	n103	Warning: Resident FPGA .
0x55C7	n104	Warning: Operational FPGA .
0x6380	F532	Drive motor parameters setup incomplete.
0x7180	F301	Motor overheat.
0x7182	F305	Motor Brake open circuit.
0x7183	F306	Motor Brake short circuit.
0x7184	F307	Motor Brake applied during enable state.
0x7185	F436	EnDAT overheated.
0x7186	n301	Warning: Motor overheated.
0x7187	F308	Voltage exceeds motor rating.
0x7188	F560	Regen near capacity, could not prevent over voltage.
0x7189	F312	Brake released when it should be applied.
0x7305	F417	Broken wire in primary feedback.
0x7380	F402	Feedback 1 Analog signal amplitude default.
0x7381	F403	Feedback 1 EnDat communication fault.
0x7382	F404	Feedback 1 illegal hall state.
0x7383	F405	Feedback 1 BiSS watchdog.
0x7384	F406	Feedback 1 BiSS multi cycle.
0x7385	F407	Feedback 1 BiSS sensor.
0x7386	F408	Feedback 1 SFD configuration.
0x7387	F409	Feedback 1 SFD UART overrun.
0x7388	F410	Feedback 1 SFD UART frame.
0x7389	F412	Feedback 1 SFD UART parity.
0x738A	F413	Feedback 1 SFD transfer timeout.
0x738C	F415	Feedback 1 SFD mult. corrupt position.
0x738D	F416	Feedback 1 SFD Transfer incomplete.
0x738E	F418	Feedback 1 power supply fault.
0x738F	F401	Feedback 1 failed to set feedback.
0x7390	n414	Warning: SFD single corrupted position.
0x7391	F419	Encoder init procedure failed.
0x7392	F534	Failed to read motor parameters from feedback device.
0x7393	F421	SFD position sensor fault.
0x7394	F463	Tamagawa encoder: overheat.
0x7395	n451	Warning: Tamagawa encoder battery.
0x7396	n423	Warning: Non volatile memory error, multiturn overflow.

Error Code	Fault/Warning	Description
0x7398	F135	Homing is needed.
0x7399	F468	FB2.Source not set.
0x739A	F469	FB1.ENCRES is not power of two.
0x739B	F423	Non volatile memory error, multiturn overflow.
0x739C	F467	Hiperface DSL fault.
0x739D	F452	Multiturn overflow not supported with this feedback.
0x739E	F465	Excessive shock detected by feedback device.
0x73A0	F453	Tamagawa encoder: communication timeout.
0x73A1	F454	Tamagawa encoder: communication transfer incomplete.
0x73A2	F456	Tamagawa encoder: communication CRC.
0x73A3	F457	Tamagawa encoder: communication start timeout.
0x73A4	F458	Tamagawa encoder: communication UART overrun.
0x73A5	F459	Tamagawa encoder: communication UART framing.
0x73A6	F460	Tamagawa encoder: over speed.
0x73A7	F461	Tamagawa encoder: contouring error.
0x73A8	F462	Tamagawa encoder: counting overflow.
0x73A9	F464	Tamagawa encoder: multiturn error.
0x73AA	F451	Tamagawa encoder: battery.
0x73B0	F486	Motor velocity exceeds emulated encoder maximum speed.
0x73B8	F420	FB3 EnDat communication fault.
0x73C5	F482	Commutation not initialized.
0x73C6	F483	Motor U phase missing.
0x73C7	F484	Motor V phase missing.
0x73C8	F485	Motor W phase missing.
0x73D0	F487	Wake and Shake. Validating positive movement failed.
0x73D1	F489	Wake and Shake. Validating negative movement failed.
0x73D2	F490	Wake and Shake. Validating commutation angle time out.
0x73D3	F491	Wake and Shake. Validating commutation angle moved too far.
0x73D4	F492	Wake and Shake. Validating commutation angle required more than MOTOR.ICONT.
0x73D5	F493	Invalid commutation detected, motor accelerates in wrong direction.
0x8130	F129	Life Guard Error or Heartbeat Error.
0x8180	n702	Warning: Fieldbus communication lost.
0x8280	n601	Warning: Modbus data rate is too high.
0x8311	F304	Motor foldback.
0x8331	F524	Drive foldback.
0x8380	n524	Warning: Drive foldback.

Error Code	Fault/Warning	Description
0x8381	n304	Warning: Motor foldback.
0x8382	n309	Warning: Motor I ² t load.
0x8383	n580	Warning: Using derivate of position when using sensorless feedback type in position mode.
0x8384	n581	Warning: Zero velocity when using induction sensorless feedback type in position mode.
0x8480	F302	Over speed.
0x8481	F703	Emergency timeout occurred while axis should disable.
0x8482	F480	Fieldbus command velocity too high.
0x8483	F481	Fieldbus command velocity too low.
0x8582	n107	Warning: Positive software position limit is exceeded.
0x8583	n108	Warning: Negative software position limit is exceeded.
0x8611	F439	Following error (user).
0x8685	F138	Instability during autotune.
0x8686	n151	Warning: Not enough distance to move; Motion Exception.
0x8687	n152	Warning: Not enough distance to move; Following Motion Exception.
0x8688	n153	Warning: Velocity Limit Violation, Exceeding Max Limit.
0x8689	n154	Warning: Following Motion Failed; Check Motion Parameters.
0x868A	n156	Warning: Target Position crossed due to Stop command.
0x86A0	n157	Warning: Homing Index pulse not found.
0x86A1	n158	Warning: Homing Reference Switch not found.
0x86A2	n159	Warning: Failed to set motion task parameters.
0x86A3	n160	Warning: Motion Task Activation Failed.
0x86A4	n161	Warning: Homing Procedure Failed.
0x86A5	F139	Target Position Over Short due to invalid Motion task activation.
0x86A6	n163	Warning: MT.NUM exceeds limit.
0x86A7	n164	Warning: Motion task is not initialized.
0x86A8	n165	Warning: Motion task target position is out.
0x86A9	n167	Warning: Software limit switch traversed.
0x86AA	n168	Warning: Invalid bit combination in the motion task control word.
0x86AB	n169	Warning: 1:1 profile cannot be triggered on the fly.
0x86AC	n170	Warning: Customer profile table is not initialized.
0x86AD	n171	Warning: Motion task activation is currently pending
0x86AE	n135	Warning: Homing is needed.
0x86AF	n174	Warning: Homing maximum distance exceeded
0x86B0	F438	Following error (numeric).
0x8780	F125	Fieldbus synchronization lost.
0x8781	n125	Warning: Fieldbus synchronization lost.

Error Code	Fault/Warning	Description
0x8AF0	n137	Warning: Homing and feedback mismatch.
0xFF00	F701	Fieldbus runtime.
0xFF01	F702	Fieldbus communication lost.
0xFF02	F529	Iu current offset limit exceeded.
0xFF03	F530	Iv current offset limit exceeded.
0xFF04	F521	Regen over power.
0xFF07	F525	Output over current.
0xFF08	F526	Current sensor short circuit.
0xFF09	F128	MPOLES/FPOLES not an integer.
0xFF0A	F531	Power stage fault.
0xFF0B	F602	Safe torque off.
0xFF0C	F131	Secondary feedback A/B line break.
0xFF0D	F130	Secondary feedback supply over current.
0xFF0E	F134	Secondary feedback illegal state.
0xFF0F	F245	External fault.
0xFF10	F136	Firmware and FPGA versions are not compatible.
0xFF11	F101	Firmware type mismatch.
0xFF12	n439	Warning: Following error (user).
0xFF13	n438	Warning: Following error (numeric).
0xFF14	n102	Warning: Operational FPGA is not a default FPGA.
0xFF15	n101	Warning: The FPGA is a laboratory FPGA.
0xFF16	n602	Warning: Safe torque off.
0xFF17	F132	Secondary feedback Z line break.
0xFF18	n603	Warning: OPMODE incompatible with CMDSOURCE.
0xFF19	n604	Warning: EMUEMODE incompatible with DRV.HANDWHEELSRC.

19.33.2 Object Dictionary

The following tables describe all objects reachable via SDO or PDO. (i.p. = in preparation).

Abbreviations:

U	= UNSIGNED	RO	= Read only
INT	= INTEGER	RW	= Read and Write
VisStr	= Visible String	WO	= Write only
		const	= Constant

19.33.2.1 Float Scaling

The scaling applied to objects which match floating-point parameters in EWV¹/Telnet are listed in the column "Float Scaling."

For example, index 607Ah is listed as 1:1 - this means that commanding a value of 1000 in SDO 607Ah is equivalent to entering MT.P 1000.000 in EWV. On the other hand, index 3598h is listed as 1000:1 - this means that commanding a value of 1000 in SDO 3598h is equivalent to entering IL.KP 1.000 in EWV.

A few parameters are listed as variable (var), because the scaling depends on other settings.

19.33.2.2 Effectiveness of PDO set-points

Some objects are having effect only in the state machine state "Operation Enabled", which is controlled by the DS402 control word. They are marked with an asterisk (*) at the PDO mapping.

19.33.2.3 Communication SDOs

Index	Sub-index	Data Type	Float Scale	Access	PDO map.	Description	ASCII object
1000h	0	U32		RO	no	Device type	—
1001h	0	U8		RO	no	Error register	—
1002h	0	U32		RO	yes	Manufacturer-specific status register	—
1003h		ARRAY				Pre-defined error field	—
1003h	0	U8		RW	no	Number of errors	—
1003h	1 to 10	U32		RO	no	standard error field	—
1005h	0	U32		RW	no	COB—ID SYNC message	—
1006h	0	U32		RW	no	Communication cycle period	—
1008h	0	VisStr		const	no	Manufacturer device name	—
1009h	0	VisStr		const	no	Manufacturer hardware version	—
100Ah	0	VisStr		const	no	Manufacturer software version	—
100Ch	0	U16		RW	no	Guard time	—
100Dh	0	U8		RW	no	Lifetime factor	—
1010h		ARRAY				Save parameters	—
1010h	0	U8		RO	no	highest sub-index	—
1010h	1	U32		RW	no	Saves the drive parameters from the RAM to the NV.	DRV.NVSAVE
1011h		ARRAY				Load parameters	—
1011h	0	U8		RO	no	highest sub-index	—
1011h	1	U32		RW	no	Loads default parameters to the RAM.	DRV.RSTVAR

¹Embedded Workbench Views

Index	Sub-index	Data Type	Float Scale	Access	PDO map.	Description	ASCII object
1012h	0	U32		RW	no	COB—ID for the Time Stamp	—
1014h	0	U32		RW	no	COB—ID for the Emergency Object	—
1016h		RECORD				Consumer heartbeat time	
1016h	0	U8		RO	no	highest sub-index	—
1016h	1	U32		RW	no	Consumer heartbeat time	—
1017h	0	U16		RW	no	Producer heartbeat time	—
1018h		RECORD				Identity Object	—
1018h	0	U8		RO	no	highest sub-index	—
1018h	1	U32		RO	no	Vendor ID	—
1018h	2	U32		RO	no	Product Code	—
1018h	3	U32		RO	no	Revision number	—
1018h	4	U32		RO	no	Serial number	
1026h		ARRAY				OS prompt	—
1026h	0	U8		RO	no	highest sub-index	—
1026h	1	U8		WO	no	StdIn	—
1026h	2	U8		RO	no	StdOut	—
1400h		RECORD				RXPDO1 communication parameter	—
1400h	0	U8		RO	no	highest sub-index	—
1400h	1	U32		RW	no	RXPDO1 COB — ID	—
1400h	2	U8		RW	no	Transmission type RXPDO1	—
1401h		RECORD				RXPDO2 communication parameter	—
1401h	0	U8		RO	no	highest sub-index	—
1401h	1	U32		RW	no	RXPDO2 COB—ID	—
1401h	2	U8		RW	no	Transmission type RXPDO2	—
1402h		RECORD				RXPDO3 communication parameter	—
1402h	0	U8		RO	no	highest sub-index	—
1402h	1	U32		RW	no	RXPDO3 COB—ID	—
1402h	2	U8		RW	no	Transmission type RXPDO3	—
1403h		RECORD				RXPDO4 communication parameter	—
1403h	0	U8		RO	no	highest sub-index	—
1403h	1	U32		RW	no	RXPDO4 COB—ID	—
1403h	2	U8		RW	no	Transmission type RXPDO4	—
1600h		RECORD				RXPDO1 mapping parameter	—
1600h	0	U8		RO	no	highest sub-index	—
1600h	1 to 8	U32		RW	no	Mapping for n—th application object	—
1601h		RECORD				RXPDO2 mapping parameter	—
1601h	0	U8		RO	no	highest sub-index	—
1601h	1 to 8	U32		RW	no	Mapping for n—th application object	—
1602h		RECORD				RXPDO3 mapping parameter	—
1602h	0	U8		RO	no	highest sub-index	—
1602h	1 to 8	U32		RW	no	Mapping for n—th application object	—

Index	Sub-index	Data Type	Float Scale	Access	PDO map.	Description	ASCII object
1603h		RECORD				RXPDO4 mapping parameter	—
1603h	0	U8		RO	no	highest sub-index	—
1603h	1 to 8	U32		RW	no	Mapping for n—th application object	—
1800h		RECORD				TXPDO1 communication parameter	—
1800h	0	U8		RO	no	highest sub-index	—
1800h	1	U32		RW	no	TXPDO1 COB—ID	—
1800h	2	U8		RW	no	Transmission type TXPDO1	—
1800h	3	U16		RW	no	Inhibit time	—
1800h	4	U8		const	no	reserved	—
1800h	5	U16		RW	no	Event timer	—
1801h		RECORD				TXPDO2 communication parameter	—
1801h	0	U8		RO	no	highest sub-index	—
1801h	1	U32		RW	no	TXPDO2 COB—ID	—
1801h	2	U8		RW	no	Transmission type TXPDO2	—
1801h	3	U16		RW	no	Inhibit time	—
1801h	4	U8		const	no	reserved	—
1801h	5	U16		RW	no	Event timer	—
1802h		RECORD				TXPDO3 communication parameter	—
1802h	0	U8		RO	no	highest sub-index	—
1802h	1	U32		RW	no	TXPDO3 COB—ID	—
1802h	2	U8		RW	no	Transmission type TXPDO3	—
1802h	3	U16		RW	no	Inhibit time	—
1802h	4	U8		const	no	reserved	—
1802h	5	U16		RW	no	Event timer	—
1803h		RECORD				TXPDO4 communication parameter	—
1803h	0	U8		RO	no	highest sub-index	—
1803h	1	U32		RW	no	TXPDO4 COB—ID	—
1803h	2	U8		RW	no	Transmission type TXPDO4	—
1803h	3	U16		RW	no	Inhibit time	—
1803h	4	U8		const	no	reserved	—
1803h	5	U16		RW	no	Event timer	—
1A00h		RECORD				Mapping parameter TXPDO1	—
1A00h	0	U8		RO	no	highest sub-index	—
1A00h	1 to 8	U32		RW	no	Mapping for n—th application object	—
1A01h		RECORD				Mapping parameter TXPDO2	—
1A01h	0	U8		RO	no	highest sub-index	—
1A01h	1 to 8	U32		RW	no	Mapping for n—th application object	—
1A02h		RECORD				Mapping parameter TXPDO3	—
1A02h	0	U8		RO	no	highest sub-index	—
1A02h	1 to 8	U32		RW	no	Mapping for n—th application object	—
1A03h		RECORD				Mapping parameter TXPDO4	—

Index	Sub-index	Data Type	Float Scale	Access	PDO map.	Description	ASCII object
1A03h	0	U8		RO	no	highest sub-index	—
1A03h	1 to 8	U32		RW	no	Mapping for n—the application object	—
1C12h		ARRAY		RW	no	RxPDO assign	—
1C12h	0	U8		RO	no	highest sub-index	—
1C13h	1 to 4	U8		RW	no	Subindex 001..004	—
1C13h		ARRAY		RW	no	TxPDO assign	—
1C13h	0	U8		RO	no	highest sub-index	—
1C13h	1 to 4	U8		RW	no	Subindex 001..004	—

19.33.2.4 Manufacturer specific SDOs

Objects 2000h to 3999h

Index	Sub-index	Data Type	Float Scale	Access	PDO map.	Description	ASCII object
2000h		ARRAY				System Warnings	—
2000h	0	U8		RO	no	highest sub-index	—
2000h	1	U32		RO	no	System Warning 1	DRV.WARNING1
2000h	2	U32		RO	no	System Warning 2	DRV.WARNING2
2000h	3	U32		RO	no	System Warning 3	DRV.WARNING3
2001h		ARRAY				System Faults	—
2001h	0	U8		RO	no	highest sub-index	—
2001h	1	U32		RO	no	System Fault 1	DRV.FAULT1
2001h	2	U32		RO	no	System Fault 2	DRV.FAULT2
2001h	3	U32		RO	no	System Fault 3	DRV.FAULT3
2001h	4	U32		RO	no	System Fault 4	DRV.FAULT4
2001h	5	U32		RO	no	System Fault 5	DRV.FAULT5
2001h	6	U32		RO	no	System Fault 6	DRV.FAULT6
2001h	7	U32		RO	no	System Fault 7	DRV.FAULT7
2001h	8	U32		RO	no	System Fault 8	DRV.FAULT8
2001h	9	U32		RO	no	System Fault 9	DRV.FAULT9
2001h	A	U32		RO	no	System Fault 10	DRV.FAULT10
2002h		ARRAY				Manufacturer status bytes	—
2002h	0	U8		RO	no	highest sub-index	—
2002h	1	U8		RO	yes	Manufacturer status bytes 1	—
2002h	2	U8		RO	yes	Manufacturer status bytes 2	—
2002h	3	U8		RO	yes	Manufacturer status bytes 3	—
2002h	4	U8		RO	yes	Manufacturer status bytes 4	—
2011h		VAR		RO		DRV.RUNTIME in seconds	DRV.RUNTIME
2012h		ARRAY				Fault history: Fault numbers	DRV.FAULTHIST
2012h	0	U8		RO	no	highest sub-index	—
2012h	1 to 20	U32		RO	no	Nth-latest entry in fault number list of fault history table	—
2013h		ARRAY				Fault history: Time stamps	DRV.FAULTHIST
2013h	0	U8		RO	no	highest sub-index	—
2013h	1 to 20	U32		RO	no	Nth-latest entry in fault time stamp list of fault history table	—
2014h		ARRAY				Mask TxPDO Channel 1	—
2014h	1	U32		RW	no	Mask (Byte 0..3)	—
2014h	2	U32		RW	no	Mask (Byte 4..7)	—
2015h		ARRAY				Mask TxPDO Channel 2	—
2015h	1	U32		RW	no	Mask (Byte 0..3)	—
2015h	2	U32		RW	no	Mask (Byte 4..7)	—
2016h		ARRAY				Mask TxPDO Channel 3	—
2016h	1	U32		RW	no	Mask (Byte 0..3)	—
2016h	2	U32		RW	no	Mask (Byte 4..7)	—
2017h		ARRAY				Mask TxPDO Channel 4	—
2017h	1	U32		RW	no	Mask (Byte 0..3)	—
2017h	2	U32		RW	no	Mask (Byte 4..7)	—
2018h		ARRAY				Firmware version	—
2018h	0	U16		const	no	highest sub-index	—

Index	Sub-index	Data Type	Float Scale	Access	PDO map.	Description	ASCII object
2018h	1	U16		const	no	Major version	—
2018h	2	U16		const	no	Minor version	—
2018h	3	U16		const	no	Revision	—
2018h	4	U16		const	no	Branch version	—
2026h		ARRAY				ASCII Channel	—
2026h	0	U8		RO	no	highest sub-index	—
2026h	1	VisStr		WO	no	Command	—
2026h	2	VisStr		RO	no	Response	—
2031h	0	VisStr		RW	no	Drive Name, length 10 bits	DRV.NAME
2032h	0	VisStr		RW	no	Drive custom identifier string, length 32 byte	DRV.CUSTOM-IDENTIFIER
204Ch		ARRAY				pv scaling factor	—
204Ch	0	U8		RO	no	highest sub-index	—
204Ch	1	INT32		RW	no	pv scaling factor numerator	—
204Ch	2	INT32		RW	no	pv scaling factor denominator	—
2050h	0	INT32	1:1	RO	yes	Position, secondary feedback	DRV.HANDWHEEL
2071h	0	INT32		RW	yes*	Target current	-
2077h	0	INT32		RO	yes	Current actual value	-
20A0h	0	INT32	var	RO	yes	Latch position 1, positive edge	CAP0.PLFB , CAP0.T
20A1h	0	INT32	var	RO	yes	Latch position 1, negative edge	CAP0.PLFB , CAP0.T
20A2h	0	INT32	var	RO	yes	Latch position 2, positive edge	CAP1.PLFB , CAP1.T
20A3h	0	INT32	var	RO	yes	Latch position 2, negative edge	CAP1.PLFB , CAP1.T
20A4h	0	U16		RW	yes	Latch control register	—
20A5h	0	U16		RW	yes	Latch status register	—
20A6h	0	INT32	var	RO	yes	Gets captured position value	CAP0.PLFB
20A7h	0	INT32	var	RO	yes	Gets captured position value	CAP1.PLFB
20B8h	0	U16		RW	yes	Clear changed digital input information	—
3405h		ARRAY				VL.ARTYPE	—
3405h	0	U8		RO	no	highest sub-index	—
3405h	1	U8		RW	no	Calculation method for BiQuad filter 1	VL.ARTYPE1
3405h	2	U8		RW	no	Calculation method for BiQuad filter 2	VL.ARTYPE2
3405h	3	U8		RW	no	Calculation method for BiQuad filter 3	VL.ARTYPE3
3405h	4	U8		RW	no	Calculation method for BiQuad filter 4	VL.ARTYPE4
3406h		ARRAY				VL BiQuad	—
3406h	0	U8		RO	no	highest sub-index	—
3406h	1	U32	1000:1	RW	no	Natural frequency of pole of anti-resonance (AR) filter 1	VL.ARPF1
3406h	2	U32	1000:1	RW	no	Natural frequency of pole of anti-resonance (AR) filter 2	VL.ARPF2

Index	Sub-index	Data Type	Float Scale	Access	PDO map.	Description	ASCII object
3406h	3	U32	1000:1	RW	no	Natural frequency of pole of anti-resonance (AR) filter 3	VL.ARPF3
3406h	4	U32	1000:1	RW	no	Natural frequency of pole of anti-resonance (AR) filter 4	VL.ARPF4
3406h	5	U32	1000:1	RW	no	Q of pole of anti-resonance (AR) filter 1	VL.ARPQ1
3406h	6	U32	1000:1	RW	no	Q of pole of anti-resonance (AR) filter 2	VL.ARPQ2
3406h	7	U32	1000:1	RW	no	Q of pole of anti-resonance (AR) filter 3	VL.ARPQ3
3406h	8	U32	1000:1	RW	no	Q of pole of anti-resonance (AR) filter 4	VL.ARPQ4
3406h	9	U32	1000:1	RW	no	Natural frequency of zero of anti-resonance (AR) filter 1	VL.ARZF1
3406h	A	U32	1000:1	RW	no	Natural frequency of zero of anti-resonance (AR) filter 2	VL.ARZF2
3406h	B	U32	1000:1	RW	no	Natural frequency of zero of anti-resonance (AR) filter 3	VL.ARZF3
3406h	C	U32	1000:1	RW	no	Natural frequency of zero of anti-resonance (AR) filter 4	VL.ARZF4
3406h	D	U32	1000:1	RW	no	Q of zero of anti-resonance filter 1	VL.ARZQ1
3406h	E	U32	1000:1	RW	no	Q of zero of anti-resonance filter 2	VL.ARZQ2
3406h	F	U32	1000:1	RW	no	Q of zero of anti-resonance filter 3	VL.ARZQ3
3406h	10	U32	1000:1	RW	no	Q of zero of anti-resonance filter 4	VL.ARZQ4
3407h		STRUCT				Velocity Filter	—
3407h	0	U8		RO	no	highest sub-index	—
3407h	1	INT32	1000:1	RW	no	10 Hz filtered VL.FB	VL.FBFILTER
3407h	2	U32	1000:1	RW	no	Gain for the velocity feed-forward	VL.KVFF
3407h	3	U32		RW	no	Gain for the acceleration feed-forward	VL.KBUSFF
3407h	4	U32	1:1	RW	no	Sets the velocity error	VL.ERR
3412h	0	INT8		RW	no	Type of regen resistor	REGEN.TYPE
3414h	0	U8		RW		Returns and sets the regen resistor fault level temperature.	REGEN.WATTEXT
3415h	0	U32	1000:1	RO	no	Thermal regen resistor time constant	REGEN.TEXT
3416h	0	U32		RO	no	Gets regen resistor's calculated power	REGEN.POWER
3417h	0	U32		RO	no	Returns a filtered version of 3416h	REGEN.POWER-FILTERED
3420h	0	U16	1000:1	RW	no	Sets the foldback fault level.	IL.FOLDFTHRESH
3421h	0	U32	1000:1	RW	no	Sets the user value for the foldback fault level.	IL.FOLDFTHRESHU
3422h	0	U32	1000:1		no	Sets friction compensation value.	IL.FRICTION

Index	Sub-index	Data Type	Float Scale	Access	PDO map.	Description	ASCII object
3423h	0	INT32	1000:1		no	A constant current command added to compensate for gravity.	IL.OFFSET
3424h	0	U16			no	Enables/disables the integrator part of the PI loop.	IL.INTEN (Password Protected)
3425h	0	U32	1000:1	RO	no	Reads the overall foldback current limit	IL.IFOLD
3426h	0	U32	1000:1	RW	no	Sets current loop acceleration feedforward gain value	IL.KACFF
3427h		RECORD				Motor protection parameters	—
3427h	0	U8		RO	no	highest sub-index	—
3427h	1	U8		RW	no		IL.MIMODE
3427h	2	U8		RW	no		IL.MI2TWTRESH
3427h	3	U32		RW	yes		IL.MI2T
3430h	0	U8		RW	no	Sets the direction for absolute motion tasks.	PL.MODPDIR
3431h	0	U16		RW	no	Sets the motion task in the drive	MT.SET
3440h		ARRAY				Controlled stop parameters	—
3440h	0	U8		RO	no	highest sub-index	—
3440h	1	U32	1:1	RW	no	Sets the deceleration value for a controlled stop.	CS.DEC
3440h	2	U32	1:1	RW	no	Sets the velocity threshold for a controlled stop.	CS.VTHRESH
3440h	3	U32		RW	no	Sets the time value for the drive velocity to be within CS.VTHRESH.	CS.TO
3441h	0	U8		RO	no	Controlled stop state	CS.STATE
3443h	0	U16		RO	no	Returns the possible reason for a drive disable	DRV.DIS
3444h	0	U16	1000:1	RO	no	Maximum current for dynamic braking	DRV.DBILIMIT
3445h	0	U32		RO	no	Emergency timeout for braking	DRV.DISTO
3450h	0	U8		WO	no	Release or enable brake	MOTOR.BRAKERLS
3451h	0	U8		RW	no	Determines which drive parameters are calculated automatically.	MOTOR.AUTASET
3452h	0	U16		RW	no	Sets the motor maximum voltage	MOTOR.VOLTMAX
3453h	0	U32		RW	no	Sets the motor temperature warning level	MOTOR.TEMPWARN
3454h	0	U32	1000:1	RW	no	Sets the thermal constant of the motor coil	MOTOR.CTF0
3455h	0	U32	1000:1	RW	no	Sets the line-to-line motor Lq	MOTOR.LQLL
3456h	0	U32	1000:1	RW	no	Sets the stator winding resistance phase-phase in ohms	MOTOR.R
3457h		RECORD				Induction Motor parameter	—
3457h	0	U8		RO	no	highest sub-index	—

Index	Sub-index	Data Type	Float Scale	Access	PDO map.	Description	ASCII object
3457h	1	INT32	1000:1	RW	no	Configuration of induction motor's rated velocity.	MOTOR.VRATED
3457h	2	U16		RW	no	Configuration of induction motor's rated voltage.	MOTOR.VOLTRATED
3457h	3	U16		RW	no	Sets the minimum voltage for V/f Control.	MOTOR.VOLTMIN
345Ah		ARRAY				Brake Control	—
345Ah	0	U8		RO	no	highest sub-index	—
345Ah	1	U16		RW	yes	Brake Control Command	—
345Ah	2	U16		RO	yes	Brake Status Response.	—
3460h		RECORD				Capture engines parameters	—
3460h	0	U8		RO	no	highest sub-index	—
3460h	1	U8		RW	no	Specifies the trigger source for the position capture.	CAP0.TRIGGER
3460h	2	U8		RW	no	Specifies the trigger source for the position capture.	CAP1.TRIGGER
3460h	3	U8		RW	no	Selects the captured value.	CAP0.MODE
3460h	4	U8		RW	no	Selects the captured value.	CAP1.MODE
3460h	5	U8		RW	no	Controls the precondition logic.	CAP0.EVENT
3460h	6	U8		RW	no	Controls the precondition logic.	CAP1.EVENT
3460h	7	U8		RW	no	Selects the capture precondition edge.	CAP0.PREEDGE
3460h	8	U8		RW	no	Selects the capture precondition edge.	CAP1.PREEDGE
3460h	9	U8		RW	no	Sets the precondition trigger.	CAP0.PRESELECT
3460h	A	U8		RW	no	Sets the precondition trigger.	CAP1.PRESELECT
3460h	B	U8		RW	no	Selects the feedback source for the capture engine 0.	CAP0.FBSOURCE
3460h	C	U8		RW	no	Selects the feedback source for the capture engine 1.	CAP1.FBSOURCE
3470h		RECORD					—
3470h	0	U8		RO	no	highest sub-index	—
3470h	1	INT8		RW	no	Sets the analog output mode.	AOUT.MODE
3470h	2	INT16	1000:1	RW	yes	Reads the analog output value.	AOUT.VALUE
3470h	3	INT16	1000:1	RW	yes	Reads and writes the analog output value.	AOUT.VALUEU
3470h	4	INT16	1000:1	RO	yes	Reads the value of the analog input signal.	AIN.VALUE
3470h	5	U32	1000:1	RW	no	Sets velocity scale factor for analog output	AOUT.VSCALE
3471h	0	U32	1:1	RW	no	Sets the analog position scale factor	AOUT.PSCALE
3472h	0	U32	1:1	RW	no	Sets analog pscale factor	AIN.PSCALE
3474h		ARRAY				DINx.PARAM	—
3474h	0	U8		RO	no	highest sub-index	—
3474h	1	U32		RW	no	Lower 32-bit part of input parameter 1	DIN1.PARAM

Index	Sub-index	Data Type	Float Scale	Access	PDO map.	Description	ASCII object
3474h	2	U32		RW	no	Lower 32-bit part of input parameter 2	DIN2.PARAM
3474h	3	U32		RW	no	Lower 32-bit part of input parameter 3	DIN3.PARAM
3474h	4	U32		RW	no	Lower 32-bit part of input parameter 4	DIN4.PARAM
3474h	5	U32		RW	no	Lower 32-bit part of input parameter 5	DIN5.PARAM
3474h	6	U32		RW	no	Lower 32-bit part of input parameter 6	DIN6.PARAM
3474h	7	U32		RW	no	Lower 32-bit part of input parameter 7	DIN7.PARAM
3474h	8	U32		RW	no	Higher 32-bit part of input parameter 1	DIN1.PARAM
3474h	9	U32		RW	no	Higher 32-bit part of input parameter 2	DIN2.PARAM
3474h	A	U32		RW	no	Higher 32-bit part of input parameter 3	DIN3.PARAM
3474h	4	U32		RW	no	Higher 32-bit part of input parameter 1	DIN1.PARAM
3474h	5	U32		RW	no	Higher 32-bit part of input parameter 2	DIN2.PARAM
3474h	6	U32		RW	no	Higher 32-bit part of input parameter 3	DIN3.PARAM
3474h	B	U32		RW	no	Higher 32-bit part of input parameter 4	DIN4.PARAM
3474h	C	U32		RW	no	Higher 32-bit part of input parameter 5	DIN5.PARAM
3474h	D	U32		RW	no	Higher 32-bit part of input parameter 6	DIN6.PARAM
3474h	E	U32		RW	no	Higher 32-bit part of input parameter 7	DIN7.PARAM
3475h		ARRAY				DOUTx.PARAM	—
3475h	0	U8		RO	no	highest sub-index	—
3475h	1	U32		RW	no	Lower 32-bit part of output parameter 1	DOUT1.PARAM
3475h	2	U32		RW	no	Lower 32-bit part of output parameter 2	DOUT2.PARAM
3475h	3	U32		RW	no	Higher 32-bit part of output parameter 1	DOUT1.PARAM
3475h	2	U32		RW	no	Higher 32-bit part of output parameter 1	DOUT1.PARAM
3475h	4	U32		RW	no	Higher 32-bit part of output parameter 2	DOUT2.PARAM
3480h	0	U32	1000:1	RW	no	Integral gain of position regulator PID loop	PL.KI
3481h		ARRAY				PL.INTMAX	—
3481h	0	U8		RO	no	highest sub-index	—
3481h	1	U32	1:1	RW	no	Input saturation	PL.INTINMAX
3481h	2	U32	1:1	RW	no	Output saturation	PL.INTOUTMAX

Index	Sub-index	Data Type	Float Scale	Access	PDO map.	Description	ASCII object
3482h	0	INT32	1:1	RO	no	Maximum value of following error in homing	HOME.PERRTHRESH
3483h	0	INT32	1:1	RW	no	Sets the position error warning level	PL.ERRWTHRESH
3484h	0	INT32	1:1	RW	no	Specification of an additional movement after homing is completed.	HOME.DIST
3490h	0	INT32	1:1	RO	no	Position feedback offset	FB1.POFFSET
3491h	0	U32		RO	no	Location of index pulse on EEO	DRV.EMUEMTURN
3492h	0	U32		RO	no	Motion status of the drive	DRV.MOTIONSTAT
3493h	0	U8		RO	no	Direction of EEO (emulated encoder output)	DRV.EMUEDIR
3494h		RECORD				WS parameters	—
3494h	0	U8		RO	no	highest sub-index	—
3494h	1	INT16	1000:1	RW	no	Sets maximum current used for wake and shake	WS.IMAX
3494h	2	INT32	1:1	RW	no	Sets the maximum movement required for wake and shake	WS.DISTMAX
3494h	3	U16		RW	no	Sets the delay for wake and shake between loops in mode 0	WS.TDELAY30
3494h	4	INT32	1:1	RW	no	Defines the maximum allowed velocity for Wake & Shake	WS.VTHRESH
3494h	5	U8		RO	no	Reads wake and shake status	WS.STATE
3494h	6	U8		RW	no	Arm Wake and Shake to start	WS.ARM
3495h	0	U16	1000:1	RW	no	Voltage level for undervoltage warning.	VBUS.UVWTHRESH
3496h		ARRAY				FBUS synchronization parameters	—
3496h	0	U8		RO	no	highest sub-index	—
3496h	1	U32		RW	no	expected time distance between clearing the PLL counter and calling the PLL function	FBUS.SYNCDIST
3496h	2	U32		RW	no	actual time distance between clearing the PLL counter and calling the PLL function	FBUS.SYNCACT
3496h	3	U32		RW	no	Time window, which is used in order to consider the drive as being synchronized	FBUS.SYNCWND
3496h	4	U32		RW	no	Time, which is used for extending or lowering the sample rate of the internal 16 [kHz] IRQ	—
3498h	0	U8		RW	no	Protection level of fieldbus against other communication channels (Telnet, Modbus..)	FBUS.PROTECTION

Index	Sub-index	Data Type	Float Scale	Access	PDO map.	Description	ASCII object
3499h	0	INT32		RW	yes	Set-point for stepper motor output through the emulated encoder output (EEO)	DRV.EMUSTEPCMD
34A0h		ARRAY				PLS Position	
34A0h	0	U8		RO	no	highest sub-index	—
34A0h	1	INT32	1:1	RW	no	Limit switch 1 compare value	PLS.P1
34A0h	2	INT32	1:1	RW	no	Limit switch 2 compare value	PLS.P2
34A0h	3	INT32	1:1	RW	no	Limit switch 3 compare value	PLS.P3
34A0h	4	INT32	1:1	RW	no	Limit switch 4 compare value	PLS.P4
34A0h	5	INT32	1:1	RW	no	Limit switch 5 compare value	PLS.P5
34A0h	6	INT32	1:1	RW	no	Limit switch 6 compare value	PLS.P6
34A0h	7	INT32	1:1	RW	no	Limit switch 7 compare value	PLS.P7
34A0h	8	INT32	1:1	RW	no	Limit switch 8 compare value	PLS.P8
34A1h		ARRAY				PLS Width	—
34A1h	0	U8		RO	no	highest sub-index	—
34A1h	1	INT32	1:1	RW	no	Sets Limit Switch1 Width	PLS.WIDTH1
34A1h	2	INT32	1:1	RW	no	Sets Limit Switch 2 Width	PLS.WIDTH2
34A1h	3	INT32	1:1	RW	no	Sets Limit Switch 3 Width	PLS.WIDTH3
34A1h	4	INT32	1:1	RW	no	Sets Limit Switch 4 Width	PLS.WIDTH4
34A1h	5	INT32	1:1	RW	no	Sets Limit Switch 5 Width	PLS.WIDTH5
34A1h	6	INT32	1:1	RW	no	Sets Limit Switch 6 Width	PLS.WIDTH6
34A1h	7	INT32	1:1	RW	no	Sets Limit Switch 7 Width	PLS.WIDTH7
34A1h	8	INT32	1:1	RW	no	Sets Limit Switch 8 Width	PLS.WIDTH8
34A2h		ARRAY				PLS Time	—
34A2h	0	U8		RO	no	highest sub-index	—
34A2h	1	U16		RW	no	Sets limit switch 1 time	PLS.T1
34A2h	2	U16		RW	no	Sets limit switch 2 time	PLS.T2
34A2h	3	U16		RW	no	Sets limit switch 3 time	PLS.T3
34A2h	4	U16		RW	no	Sets limit switch 4 time	PLS.T4
34A2h	5	U16		RW	no	Sets limit switch 5 time	PLS.T5
34A2h	6	U16		RW	no	Sets limit switch 6 time	PLS.T6
34A2h	7	U16		RW	no	Sets limit switch 7 time	PLS.T7
34A2h	8	U16		RW	no	Sets limit switch 8 time	PLS.T8
34A3h		ARRAY				PLS Configuration	—
34A3h	0	U8		RO	no	highest sub-index	—
34A3h	1	U16		RW	no	Enables the limit switches	PLS.EN
34A3h	2	U16		RW	no	Resets limit switches	PLS.RESET
34A3h	3	U16		RW	no	Selects limit switch mode	PLS.MODE
34A3h	4	U16		RW	no	Reads the limit switch state	PLS.STATE
34A4h	0	U8		RW	no	Sets limit switch units	PLS.UNITS
34A8h	0	INT32		RW	no	Sets the Compare 0 modulo value	CMP0.MODVALUE
34A9h		ARRAY				Compare0 modulo bounds	—
34A9h	0	U8		RO	no	highest sub-index	—
34A9h	1	U8		RW	no	Compare0 modulo bound 1	CMP0.MODBOUND1
34A9h	2	U8		RW	no	Compare0 modulo bound 2	CMP0.MODBOUND2
34AAh		ARRAY				CMP0 setpoints	—
34AAh	0	U8		RO	no	highest sub-index	—
34AAh	1	INT32		RW	no	Compare0 setpoint 0	CMP0.SETPOINT 0

Index	Sub-index	Data Type	Float Scale	Access	PDO map.	Description	ASCII object
34AAh	2	INT32		RW	no	Compare0 setpoint 1	CMP0.SETPOINT 1
34AAh	3	INT32		RW	no	Compare0 setpoint 2	CMP0.SETPOINT 2
34AAh	4	INT32		RW	no	Compare0 setpoint 3	CMP0.SETPOINT 3
34AAh	5	INT32		RW	no	Compare0 setpoint 4	CMP0.SETPOINT 4
34AAh	6	INT32		RW	no	Compare0 setpoint 5	CMP0.SETPOINT 5
34AAh	7	INT32		RW	no	Compare0 setpoint 6	CMP0.SETPOINT 6
34AAh	8	INT32		RW	no	Compare0 setpoint 7	CMP0.SETPOINT 7
34ABh		ARRAY				CMP0 widths	—
34ABh	0	U8		RO	no	highest sub-index	—
34ABh	1	INT32		RW	no	Compare0 width 0	CMP0.WIDTH 0
34ABh	2	INT32		RW	no	Compare0 width 1	CMP0.WIDTH 1
34ABh	3	INT32		RW	no	Compare0 width 2	CMP0.WIDTH 2
34ABh	4	INT32		RW	no	Compare0 width 3	CMP0.WIDTH 3
34ABh	5	INT32		RW	no	Compare0 width 4	CMP0.WIDTH 4
34ABh	6	INT32		RW	no	Compare0 width 5	CMP0.WIDTH 5
34ABh	7	INT32		RW	no	Compare0 width 6	CMP0.WIDTH 6
34ABh	8	INT32		RW	no	Compare0 width 7	CMP0.WIDTH 7
34ACh		ARRAY				CMP0 widthtype	—
34ACh	0	U8		RO	no	highest sub-index	—
34ACh	1	U8		RW	no	Compare0 widthtype 0	CMP0.WIDTHTYPE 0
34ACh	2	U8		RW	no	Compare0 widthtype 1	CMP0.WIDTHTYPE 1
34ACh	3	U8		RW	no	Compare0 widthtype 2	CMP0.WIDTHTYPE 2
34ACh	4	U8		RW	no	Compare0 widthtype 3	CMP0.WIDTHTYPE 3
34ACh	5	U8		RW	no	Compare0 widthtype 4	CMP0.WIDTHTYPE 4
34ACh	6	U8		RW	no	Compare0 widthtype 5	CMP0.WIDTHTYPE 5
34ACh	7	U8		RW	no	Compare0 widthtype 6	CMP0.WIDTHTYPE 6
34ACh	8	U8		RW	no	Compare0 widthtype 7	CMP0.WIDTHTYPE 7
34ADh		ARRAY				CMP0 modes	—
34ADh	0	U8		RO	no	highest sub-index	—
34ADh	1	U8		RW	no	Compare0 mode 0	CMP0.MODE 0
34ADh	2	U8		RW	no	Compare0 mode 1	CMP0.MODE 1
34ADh	3	U8		RW	no	Compare0 mode 2	CMP0.MODE 2
34ADh	4	U8		RW	no	Compare0 mode 3	CMP0.MODE 3
34ADh	5	U8		RW	no	Compare0 mode 4	CMP0.MODE 4
34ADh	6	U8		RW	no	Compare0 mode 5	CMP0.MODE 5
34ADh	7	U8		RW	no	Compare0 mode 6	CMP0.MODE 6
34ADh	8	U8		RW	no	Compare0 mode 7	CMP0.MODE 7
34B0h		ARRAY				USER.DWORDS for writing of feedback memory	—
34B0h	0	U8		RO	no	highest sub-index	—
34B0h	1	U32		RW	no	FB1.USERDWORD1	FB1.USERDWORD1
34B0h	2	U32		RW	no	FB1.USERDWORD2	FB1.USERDWORD2
34B1h		ARRAY				USER.WORDS for writing of feedback memory	—
34B1h	0	U8		RO	no	highest sub-index	—
34B1h	1	U16		RW	no	FB1.USERWORD1	FB1.USERWORD1
34B1h	2	U16		RW	no	FB1.USERWORD2	FB1.USERWORD2
34B1h	3	U16		RW	no	FB1.USERWORD3	FB1.USERWORD3
34B1h	4	U16		RW	no	FB1.USERWORD4	FB1.USERWORD4

Index	Sub-index	Data Type	Float Scale	Access	PDO map.	Description	ASCII object
34B2h		ARRAY				USER.BYTES for writing of feedback memory	—
34B2h	0	U8		RO	no	highest sub-index	—
34B2h	1	U8		RW	no	FB1.USERBYTE1	FB1.USERBYTE1
34B2h	2	U8		RW	no	FB1.USERBYTE2	FB1.USERBYTE2
34B2h	3	U8		RW	no	FB1.USERBYTE3	FB1.USERBYTE3
34B2h	4	U8		RW	no	FB1.USERBYTE4	FB1.USERBYTE4
34B2h	5	U8		RW	no	FB1.USERBYTE5	FB1.USERBYTE5
34B2h	6	U8		RW	no	FB1.USERBYTE6	FB1.USERBYTE6
34B2h	7	U8		RW	no	FB1.USERBYTE7	FB1.USERBYTE7
34B2h	8	U8		RW	no	FB1.USERBYTE8	FB1.USERBYTE8
34B8h	0	INT32		RW	no	Sets the Compare 1 modulo value	CMP1.MODVALUE
34B9h		ARRAY				Compare1 modulo bounds	—
34B9h	0	U8		RO	no	highest sub-index	—
34B9h	1	U8		RW	no	Compare1 modulo bound 1	CMP1.MODBOUND1
34B9h	2	U8		RW	no	Compare1 modulo bound 2	CMP1.MODBOUND2
34BAh		ARRAY				CMP1 setpoints	—
34BAh	0	U8		RO	no	highest sub-index	—
34BAh	1	INT32		RW	no	Compare1 setpoint 0	CMP1.SETPOINT 0
34BAh	2	INT32		RW	no	Compare1 setpoint 1	CMP1.SETPOINT 1
34BAh	3	INT32		RW	no	Compare1 setpoint 2	CMP1.SETPOINT 2
34BAh	4	INT32		RW	no	Compare1 setpoint 3	CMP1.SETPOINT 3
34BAh	5	INT32		RW	no	Compare1 setpoint 4	CMP1.SETPOINT 4
34BAh	6	INT32		RW	no	Compare1 setpoint 5	CMP1.SETPOINT 5
34BAh	7	INT32		RW	no	Compare1 setpoint 6	CMP1.SETPOINT 6
34BAh	8	INT32		RW	no	Compare1 setpoint 7	CMP1.SETPOINT 7
34BBh		ARRAY				CMP1 widths	—
34BBh	0	U8		RO	no	highest sub-index	—
34BBh	1	INT32		RW	no	Compare1 width 0	CMP1.WIDTH 0
34BBh	2	INT32		RW	no	Compare1 width 1	CMP1.WIDTH 1
34BBh	3	INT32		RW	no	Compare1 width 2	CMP1.WIDTH 2
34BBh	4	INT32		RW	no	Compare1 width 3	CMP1.WIDTH 3
34BBh	5	INT32		RW	no	Compare1 width 4	CMP1.WIDTH 4
34BBh	6	INT32		RW	no	Compare1 width 5	CMP1.WIDTH 5
34BBh	7	INT32		RW	no	Compare1 width 6	CMP1.WIDTH 6
34BBh	8	INT32		RW	no	Compare1 width 7	CMP1.WIDTH 7
34BCh		ARRAY				CMP1 widthtype	—
34BCh	0	U8		RO	no	highest sub-index	—
34BCh	1	U8		RW	no	Compare1 widthtype 0	CMP1.WIDTHTYPE 0
34BCh	2	U8		RW	no	Compare1 widthtype 1	CMP1.WIDTHTYPE 1
34BCh	3	U8		RW	no	Compare1 widthtype 2	CMP1.WIDTHTYPE 2
34BCh	4	U8		RW	no	Compare1 widthtype 3	CMP1.WIDTHTYPE 3
34BCh	5	U8		RW	no	Compare1 widthtype 4	CMP1.WIDTHTYPE 4
34BCh	6	U8		RW	no	Compare1 widthtype 5	CMP1.WIDTHTYPE 5
34BCh	7	U8		RW	no	Compare1 widthtype 6	CMP1.WIDTHTYPE 6
34BCh	8	U8		RW	no	Compare1 widthtype 7	CMP1.WIDTHTYPE 7
34BDh		ARRAY				CMP1 modes	—
34BDh	0	U8		RO	no	highest sub-index	—
34BDh	1	U8		RW	no	Compare1 mode 0	CMP1.MODE 0

Index	Sub-index	Data Type	Float Scale	Access	PDO map.	Description	ASCII object
34BDh	2	U8		RW	no	Compare1 mode 1	CMP1.MODE 1
34BDh	3	U8		RW	no	Compare1 mode 2	CMP1.MODE 2
34BDh	4	U8		RW	no	Compare1 mode 3	CMP1.MODE 3
34BDh	5	U8		RW	no	Compare1 mode 4	CMP1.MODE 4
34BDh	6	U8		RW	no	Compare1 mode 5	CMP1.MODE 5
34BDh	7	U8		RW	no	Compare1 mode 6	CMP1.MODE 6
34BDh	8	U8		RW	no	Compare1 mode 7	CMP1.MODE 7
34C0h		ARRAY				Compare0 handling	—
34C0h	0	U8		RO	no	highest sub-index	—
34C0h	1	U16		RW	yes	Compare0 arm setpoints	CMP0.ARM 0..7
34C0h	2	U16		RW	yes	Compare0 states	CMP0.STATE 0..7
34C1h		ARRAY				Compare1 handling	—
34C1h	0	U8		RO	no	highest sub-index	—
34C1h	1	U16		RW	yes	Compare1 arm setpoints	CMP1.ARM 0..7
34C1h	2	U16		RW	yes	Compare1 states	CMP1.STATE 0..7
3501h	0	INT32	1:1	RW	no	Acceleration ramp	DRV.ACC, also see "6083h" (→ p. 972)
3502h	0	INT32	1:1	RW	no	Acceleration ramp for homing/jog modes	HOME.ACC
3506h	0	INT32			no	Action that hardware enable digital input will perform.	DRV.HWENMODE
3509h	0	INT32	1000:1	RO	no	Analog input voltage	AIN.VALUE
3522h	0	INT32	1:1	RW	no	Deceleration rate	DRV.DEC, also see "6084h" (→ p. 972)
3524h	0	INT32	1:1	RW	no	Deceleration ramp for homing/jog modes	HOME.DEC
352Ah	0	INT32		RW	no	Direction of movements	DRV.DIR
3533h	0	U32		RO	no	Resolution of motor encoder	FB1.ENCRES
3534h	0	U32		RO	no	Mode of EEO connector	DRV.EMUEMODE
3535h	0	U32		RO	no	Resolution of EEO	DRV.EMUERES
3537h	0	U32		RO	no	Location of EEO index pulse	DRV.EMUEZOFFSET
353Bh	0	INT32		RO	no	Selection of the feedback type	FB1.SELECT
3542h	0	U32	1000:1	RW	no	Position Control Loop: Proportional Gain	PL.KP
3548h	0	U32	1000:1	RW	no	Velocity Control Loop: Proportional Gain	VL.KP
354Bh	0	INT32	1000:1	RW	no	Sets the velocity loop velocity feedforward gain value	VL.KVFF
354Dh	0	INT32	1000:1	RW	no	Velocity Control Loop: I-Integration Time	VL.KI
3558h	0	INT32	1000:1	RO	no	Current Monitor	IL.FB
3559h	0	INT32	1000:1	RO	no	Drive Ifold	IL.DIFOLD
355Ah	0	INT32	1000:1	RW	no	I2T Warning	IL.FOLDWTHRESH
3562h	0	INT32		RW	no	Function of Digital Input 1	DIN1.MODE
3565h	0	INT32		RW	no	Function of Digital Input 2	DIN2.MODE
3568h	0	INT32		RW	no	Function of Digital Input 3	DIN3.MODE
356Bh	0	INT32		RW	no	Function of Digital Input 4	DIN4.MODE
356Eh	0	INT32	1000:1	RW	no	Application Peak Current, positive direction	IL.LIMITP

Index	Sub-index	Data Type	Float Scale	Access	PDO map.	Description	ASCII object
356Fh	0	INT32	1000:1	RW	no	Application Peak Current, negative direction	IL.LIMITN
3586h	0	U32		RW	no	Sets the motor temperature fault level	MOTOR.TEMPFAULT
3587h	0	INT32		RW	no	Select Motor Holding Brake	MOTOR.BRAKE
358Eh	0	U32	1000:1	RW	no	Motor Continuous Current Rating	MOTOR.ICONT
358Fh	0	U32	1000:1	RW	no	Motor Peak Current Rating	MOTOR.IPEAK
3593h	0	U32	1000:1	RW	no	Sets the torque constant of the motor	MOTOR.KT
3596h	0	U32	1000:1	RO	no	Sets the proportional gain of the d-component current PI-regulator as a percentage of IL.KP	IL.KPDRATIO
3598h	0	INT32	1000:1	RW	no	Absolute Gain of Current Control loop	IL.KP
359Ch	0	U32		RW	no	Sets the motor phase.	MOTOR.PHASE
359Dh	0	U32		RW	no	Sets the number of motor poles	MOTOR.POLES
35A3h	0	U32		RW	no	Sets the maximum motor speed	MOTOR.VMAX
35A4h	0	INT32	1000:1	RW	no	Maximum motor current	IL.MIFOLD
35ABh	0	U32	1000:1	RW	no	Sets the motor inertia	MOTOR.INERTIA
35AFh	0	U32		RW	no	Sets the digital output 1 mode	DOOUT1.MODE
35B2h	0	U32		RW	no	Sets the digital output 2 mode	DOOUT2.MODE
35B4h	0	INT32		RW	no	Operating Mode	DRV.OPMODE
35B9h	0	INT32		RW	no	Control for Motion Task 0	MT.CNTL
35BCh	0	INT32		RW	no	Next Task Number for Motion Task 0	MT.MTNEXT
35C2h	0	INT32		RW	no	Select regen resistor	REGEN.REXT
35C5h	0	INT32	1:1	RO	no	Actual Following Error	PL.ERR
35C6h	0	INT32	1:1	RW	no	In-Position Window	MT.TPOSWND
35C7h	0	INT32	1:1	RW	no	Max. Following Error	PL.ERRFTHRESH
35CAh	0	INT32		RW	no	Position Resolution (Numerator)	UNIT.PIN
35CBh	0	INT32		RW	no	Position Resolution (Denominator)	UNIT.POUT
35CFh	0	INT32		RW	no	reserved	PL.MODPEN
35D2h	0	U32		RO	no	Mechanical Position	FB1.MECHPOS
35E2h	0	U32	1:1	RW	no	Sets the current limit during homing procedure to a mechanical stop	HOME.IPEAK
35EBh	0	INT32		WO	no	Save Data in EEPROM	DRV.NVSAVE
35F0h	0	INT32		WO	no	Set Reference Point	HOME.SET
35FEh	0	INT32		WO	no	Stop Motion Task	DRV.STOP
35FFh	0	U32		RW	no	Selects between disable immediately or stop and then disable	DRV.DISMODE
3610h	0	INT32		RO	no	Ambient Temperature	DRV.TEMPERATURES
3611h	0	INT32		RO	no	Heat Sink Temperature	DRV.TEMPERATURES
3612h	0	INT32		RO	no	Motor Temperature	MOTOR.TEMP

Index	Sub-index	Data Type	Float Scale	Access	PDO map.	Description	ASCII object
3617h	0	U32	1:1	RW	no	Undervoltage mode	VBUS.UVMODE
3618h	0	INT32	1:1	RO	no	Actual Velocity	VL.FB
361Ah	0	INT32		RO	no	DC-bus voltage	VBUS.VALUE
361Dh	0	U32	1000:1	RW	no	Voltage level for undervoltage fault	VBUS.UVFTHRESH
3622h	0	INT32	1:1	RW	no	Max. Velocity	VL.LIMITP
3623h	0	INT32	1:1	RW	no	Max. Negative Velocity	VL.LIMITN
3627h	0	INT32	1:1	RW	no	Overspeed	VL.THRESH
3629h	0	INT32	1000:1	RW	no	SW1 Velocity Scaling Factor	AIN.VSCALE
3637h	0	INT32	1:1	RW	no	reserved	PL.MODP1
3638h	0	INT32	1:1	RW	no	reserved	PL.MODP2
3656h	0	U64	1:1	RW	no	Initial feedback position	FB1.ORIGIN
3659h	0	INT32		RW	no	Type of acceleration setpoint for the system	UNIT.ACCROTARY
365Bh	0	INT32		RW	no	Presetting for motion task that is processed later	MT.NUM
365Fh	0	INT32		RW	no	Systemwide Definition of Velocity/Speed	UNIT.VROTARY
3660h	0	INT32		RW	no	Set Resolution of the Position	UNIT.PROTARY
366Eh	0	INT32		RW	no	Disable Delaytime with Holding Brake	MOTOR.TBRAKEAPP
366Fh	0	INT32		RW	no	Enable Delaytime with Holding Brake	MOTOR.TBRAKERLS
3683h	0	U16		RW	no	Delay for wake and shake timing	WS.TDELAY1
3685h	0	U16		RW	no	Sets delay for wake and shake timing	WS.TDELAY2
36D0h	0	U16		RW	no	Sets wake and shake current-vector appliance time	WS.T
36D1h	0	U32	1:1	RW	no	Sets the minimum movement required for wake and shake	WS.DISTMIN
36D7h	0	U32	1000:1	RW	no	Sets homing auto move flag	HOME.AUTOMOVE
36E2h	0	U8		RW	no	Sets the number of repetitions for wake and shake	WS.NUMLOOPS
36E5h	0	U32		RW	no	CAN baud rate selection	FBUS.PARAM01
36E6h	0	U32		RW	no	pll synchronization	FBUS.PARAM02
36E7h	0	U32		RW	no	-	FBUS.PARAM03
36E8h	0	U32		RW	no	SYNC surveillance	FBUS.PARAM04
36E9h	0	U32		RW	no	-	FBUS.PARAM05
36EAh	0	U32		RW	no	-	FBUS.PARAM06
36EBh	0	U32		RW	no	-	FBUS.PARAM07
36ECh	0	U32		RW	no	-	FBUS.PARAM08
36EDh	0	U32		RW	no	-	FBUS.PARAM09
36EEh	0	U32		RW	no	-	FBUS.PARAM10
36F6h	0	INT32		RW	no	Function of Digital Input 5	DIN5.MODE
36F9h	0	INT32		RW	no	Function of Digital Input 6	DIN6.MODE
36FCh	0	U32		RW	no	Function of Digital Input 7	DIN7.MODE
3856h	0	INT32	1:1	RW	no	velocity window for profile position mode	MT.TVELWND

Objects 5000h to 5999h

Index	Sub-index	Data Type	Float Scale	Access	PDO map.	Description	ASCII object
5000h	0	UINT32		RW	no	Analog input low-pass filter cutoff frequency.	AIN.CUTOFF
5001h	0	UINT32		RW	no	Analog input signal dead-band.	AIN.DEADBAND
5002h	0	UINT32		RW	no	Analog current scale factor.	AIN.ISCALE
5003h	0	UINT32		RW	no	Analog input offset.	AIN.OFFSET
5009h	0	UINT32		RW	no	Analog current scale factor.	AOUT.ISCALE
500Bh	0	UINT32		RW	no	Analog output offset.	AOUT.OFFSET
5013h	0	UINT32		RW	no	Controls how often the excitation is updated.	BODE.EXCITEGAP
5015h	0	UINT32		RW	no	Current command value used during the Bode procedure.	BODE.IAMP
5016h	0	UINT32		RW	no	Sets whether the excitation uses current or velocity excitation type.	BODE.INJECTPOINT
5019h	0	UINT32		RW	no	Length of the PRB signal before it repeats.	BODE.PRBDEPTH
5060h	0	UINT32		RW	no	Sets the fault relay mode.	DOUT.RELAYMODE
5080h	0	UINT32		RW	no	Default state of the software enable.	DRV.ENDEFAULT
5083h	0	UINT32		RW	no	Continuous rated current value.	DRV.ICONT
5084h	0	UINT32		RW	no	Peak rated current value.	DRV.IPEAK
5085h	0	UINT32		RW	no	Current that will be used during the DRV.ZERO procedure.	DRV.IZERO
508Ch	0	UINT32		RW	no	Number of Biss Sensor (Position) Bits for the BiSS Mode C encoder in use.	FB1.BISSBITS
508Fh	0	UINT32		RW	no	Initial feedback value as signed or unsigned.	FB1.INITSIGNED
5096h	0	UINT32		RW	no	Current value used during the phase finding procedure (PFB.PFIND=1)	FB1.PFINDCMDU
5097h	0	UINT32		RW	no	Number of feedback poles.	FB1.POLES
5099h	0	UINT32		RW	no	Resolver nominal transformation ratio.	FB1.RESKTR
509Ah	0	UINT32		RW	no	Electrical degrees of phase lag in the resolver.	FB1.RESREFPHASE
509Ch	0	UINT32		RW	no	Controls tracking calibration algorithm.	FB1.TRACKINGCAL
50B1h	0	UINT32		RW	no	Number of successful synchronized cycles needed to lock the PLL.	FBUS.PLLTHRESH
50BBh	0	UINT32		RW	no	Denominator of the electronic gearing ratio; active in opmode 2 (position) only.	GEAR.IN

Index	Sub-index	Data Type	Float Scale	Access	PDO map.	Description	ASCII object
50BCh	0	UINT32		RW	no	Electronic gearing mode; active in opmode 2 (position) only.	GEAR.MODE
50BEh	0	UINT32		RW	no	Numerator of the electronic gearing ratio; active in opmode 2 (position) only.	GEAR.OUT
50C5h	0	UINT32		RW	no	Homing direction	HOME.DIR
50CBh	0	UINT32		RW	no	Homing mode	HOME.MODE
50E2h	0	UINT32		RW	no	Current loops fieldbus injected feed-forward gain	IL.KBUSFF
50FBh	0	UINT32		RW	no	Motor pitch.	MOTOR.PITCH
50FEh	0	UINT32		RW	no	Type of thermal resistor inside the motor.	MOTOR.RTYPE
5104h	0	UINT32		RW	no	Motor type.	MOTOR.TYPE
510Eh	0	UINT32		RW	no	Motion task to be triggered after an emergency stop procedure; active in opmode 2 (position) only.	MT.EMERGMT
5121h	0	UINT32		RW	no	Type of following error warning and fault usage.	PL.ERRMODE
5128h	0	UINT32		RW	no	Feedback source for the position loop.	PL.FBSOURCE
5175h	0	UINT32		RW	no	Service motion current 1; active in opmode 0 (torque) only.	SM.I1
5176h	0	UINT32		RW	no	Service motion current 2; active in opmode 0 (torque) only.	SM.I2
5177h	0	UINT32		RW	no	Service motion mode.	SM.MODE
5179h	0	UINT32		RW	no	Service motion time 1.	SM.T1
517Ah	0	UINT32		RW	no	Service motion time 2.	SM.T2
517Eh	0	UINT32		RW	no	Enables and disables software travel limit switches.	SWLS.EN
5184h	0	UINT32		RW	no	Linear acceleration/deceleration units.	UNIT.ACCLINEAR
5187h	0	UINT32		RW	no	Linear position units.	UNIT.PLINEAR
518Ah	0	UINT32		RW	no	Linear velocity units.	UNIT.VLINEAR
518Eh	0	UINT32		RW	no	Voltage level for over voltage warning.	VBUS.OVWTHRESH
51AEh	0	UINT32		RW	no	Feedback source for the velocity loop; active in opmodes 1 (velocity) and 2 (position) only.	VL.FBSOURCE
51B0h	0	UINT32		RW	no	Mode of velocity generation (Observer, d/dt); active in opmodes 1 (velocity) and 2 (position) only.	VL.GENMODE
51B3h	0	UINT32		RW	no	Scales the observer velocity signal; active in opmodes 1 (velocity) and 2 (position) only.	VL.KO

Index	Sub-index	Data Type	Float Scale	Access	PDO map.	Description	ASCII object
51B8h	0	UINT32		RW	no	Ratio of the estimated load moment of inertia relative to the motor moment of inertia; active in opmodes 1 and 2 only.	VL.LMJR
51BAh	0	UINT32		RW	no	Bandwidth of the observer in Hz.	VL.OBSBW
51BBh	0	UINT32		RW	no	Observer operating mode.	VL.OBSMODE
51CBh	0	UINT32		RW	no	Filter mode for Digital In 1.	DIN1.FILTER
51CCh	0	UINT32		RW	no	Filter mode for Digital In 2.	DIN2.FILTER
51CDh	0	UINT32		RW	no	Filter mode for Digital In 3.	DIN3.FILTER
51CEh	0	UINT32		RW	no	Filter mode for Digital In 4.	DIN4.FILTER
51CFh	0	UINT32		RW	no	Filter mode for Digital In 5.	DIN5.FILTER
51D0h	0	UINT32		RW	no	Filter mode for Digital In 6.	DIN6.FILTER
51D1h	0	UINT32		RW	no	Filter mode for Digital In 7.	DIN7.FILTER
51E7h	0	UINT32		RW	no	Modbus User Units Input parameter	MODBUS.PIN
51E8h	0	UINT32		RW	no	Modbus User Units Output parameter.	MODBUS.POUT
51E9h	0	UINT32		RW	no	Feedback Resolution (per rev) over Modbus.	MODBUS.PSCALE
51ECh	0	UINT32		RW	no	Secondary feedback (FB2) resolution.	FB2.ENCRECRES
51EDh	0	UINT32		RW	no	Mode for the second feedback inputs and high speed digital inputs.	FB2.MODE
51EEh	0	UINT32		RW	no	Source for the second feedback input.	FB2.SOURCE
51EFh	0	UINT32		RW	no	Brake apply timeout for vertical axis.	MOTOR.TBRAKETO
51F0h	0	UINT32		RW	no	i.p.	MODBUS.MSGLOG
520Ch	0	UINT32		RW	no	Scaling mode for Modbus values.	MODBUS.SCALING
520Dh	0	UINT32		RW	no	Encoder output pulse width for modes 6 to 7.	DRV.EMUEPULSE-WIDTH
520Eh	0	UINT32		RW	no	Enable/disable motor velocity vs. maximum emulated encoder velocity monitoring function.	DRV.EMUECHECK-SPEED
5251h	0	UINT32		RW	no	Analog input deadband mode.	AIN.DEADBANDMODE
5252h	0	UINT32		RW	no	Analog input mode	AIN.MODE
5253h	0	UINT32		RW	no	Direction of IOs from X9.	DIO10.DIR
5254h	0	UINT32		RW	no	Inverting the output voltage of the IO, when in the output direction.	DIO10.INV
5255h	0	UINT32		RW	no	Direction of IOs from X9.	DIO11.DIR
5256h	0	UINT32		RW	no	Inverting the output voltage of the IO, when in the output direction.	DIO11.INV
5257h	0	UINT32		RW	no	Direction of IOs from X9.	DIO9.DIR

Index	Sub-index	Data Type	Float Scale	Access	PDO map.	Description	ASCII object
5258h	0	UINT32		RW	no	Inverting the output voltage of the IO, when in the output direction.	DIO9.INV
5259h	0	UINT32		RW	no	Fault Action for Fault 130.	FAULT130.ACTION
525Ah	0	UINT32		RW	no	Fault Action for Fault 131.	FAULT131.ACTION
525Bh	0	UINT32		RW	no	Fault Action for Fault 132.	FAULT132.ACTION
525Ch	0	UINT32		RW	no	Fault Action for Fault 133.	FAULT134.ACTION
525Dh	0	UINT32		RW	no	Fault Action for Fault 702.	FAULT702.ACTION
525Eh	0	UINT32		RW	no	Method of acquiring IP Address.	IP.MODE
525Fh	0	UINT32		RW	no	Load inertia.	LOAD.INERTIA
5260h	0	UINT32		RW	no	Motor back EMF constant.	MOTOR.KE
5261h	0	UINT32		RW	no	Changing voltage thresholds.	VBUS.HALFVOLT
5262h	0	UINT32		RW	no	Direction for the second feedback input (X9 and X7).	FB2.DIR
5263h	0	UINT32		RW	no	Feedback for handwheel operation.	DRV.HANDWHEELSRC
5264h	0	UINT32		RW	no	Delay time between inactive Hardware Enable input and drive disable.	DRV.HWENDELAY
5265h	0	UINT32		RW	no	Index into the Current Loop Gain Scheduling Table.	IL.KPLOOKUPINDEX
5266h	0	UINT32		RW	no	Value of the current loop gain scheduling index.	IL.KPLOOKUPVALUE
5267h	0	UINT32		RW	no	Fault Action for Fault 451.	FAULT451.ACTION
5268h	0	UINT32		RW	no	Brake Immediately in the case of a drive disable.	MOTOR.BRAKEIMM
5352h	0	UINT16		RW	no	Amount of time a communication error must be present before an W&S-fault is thrown.	WS.CHECKT
535Ch	0	UINT16		RW	no	Sets the calming time of the motor for Wake & Shake mode 1.	WS.TSTANDSTILL
535Dh	0	UINT16		RW	no	Time for the ramp up current in Wake & Shake mode 1.	WS.TIRAMP
5360h	0	UINT16		RW	no	Rotor time constant.	MOTOR.IMTR
5361h	0	UINT8		RW	no	Sets the feedback source for the current loop for MOTOR.TYPE4.	IL.FBSOURCE
5362h	0	UINT32		RW	no	The direct-axis current set point used for induction machine closed-loop control.	MOTOR.IMID
538Bh	0	UINT16		RW	no	tbd	DRV.EMUESTEPMODE
538Ch	0	UINT16		RW	no	tbd	DRV.EMUESTEPSTATUS
538Dh	0	UINT16		RW	no	tbd	DRV.EMUESTEPVMAX
538Fh	0	INT8		RW	no	Compare engine 0 source	CMP0.SOURCE
5390h	0	INT8		RW	no	Compare engine 1 source	CMP1.SOURCE
5394h	0	U16		RW	no	Compare engine 0 output mask	CMP0.OUTMASK

Index	Sub-index	Data Type	Float Scale	Access	PDO map.	Description	ASCII object
539Bh	0	U16		RW	no	Compare engine 1 output mask	CMP1.OUTMASK
53A6h	0	U8		RW	no	Compare engine 0 modulo enable	CMP0.MODEN
53ADh	0	U8		RW	no	Compare engine 1 modulo enable	CMP1.MODEN
53B1h	0	U32		RW	no	Compare engine 0 advance	CMP0.ADVANCE
53B2h	0	U32		RW	no	Compare engine 1 advance	CMP1.ADVANCE

19.33.2.5 Profile specific SDOs

Index	Sub-index	Data Type	Float Scale	Access	PDO map.	Description	ASCII object
6040h	0	U16		WO	yes	Control word	—
6041h	0	U16		RO	yes	Status word	—
6060h	0	INT8		RW	yes	Modes of Operation	—
6061h	0	INT8		RO	yes	Modes of Operation Display	—
6063h	0	INT32		RO	yes	Position actual value (increments)	—
6064h	0	INT32	1:1	RO	yes	Position actual value (position units)	PL.FB
6065h	0	U32	1:1	RW	no	Following error window	PL.ERRFTHRESH
606Bh	0	INT32	1:1	RO	no	Velocity demand value	VL.CMD
606Ch	0	INT32	1000:1	RO	yes	Velocity actual value (PDO in RPM)	VL.FB
606Dh	0	U16		RW	yes	Velocity window	—
606Eh	0	U16		RW	yes	Velocity window time	—
6071h	0	INT16		RW	yes*	Target torque	—
6072h	0	U16		RW	yes*	Max torque	—
6073h	0	U16		RW	no	Max current	—
6077h	0	INT16		RO	yes	Torque actual value	—
607Ah	0	INT32	1:1	RW	yes	Target position	MT.P
607Ch	0	INT32	1:1	RW	no	Reference offset	HOME.P
607Dh		ARRAY				Software position limit	
607Dh	0	U8		RO	no	highest sub-index	—
607Dh	1	INT32	1:1	RW	no	Software position limit 1	SWLS.LIMIT0
607Dh	2	INT32	1:1	RW	no	Software position limit 2	SWLS.LIMIT1
6081h	0	U32	1:1	RW	yes	Profile Velocity	MT.V
6083h	0	U32	1:1	RW	yes	Profile Acceleration	MT.ACC , DRV.ACC
6084h	0	U32	1:1	RW	yes	Profile Deceleration	MT.DEC , DRV.DEC
608Fh		ARRAY				Position encoder resolution	—
608Fh	0	U8		RO	no	highest sub-index	—
608Fh	1	U32		RW	no	Encoder increments	—
608Fh	2	U32		RW	no	Motor revolutions	—
6091h		ARRAY				Gear ratio	—
6091h	0	U8		RO	no	highest sub-index	—
6091h	1	U32		RW	no	Motor revolution	—
6091h	2	U32		RW	no	Shaft revolutions	—

Index	Sub-index	Data Type	Float Scale	Access	PDO map.	Description	ASCII object
6092h		ARRAY				Feed constant	—
6092h	0	U8		RO	no	highest sub-index	—
6092h	1	U32		RW	no	Feed	UNIT.PIN
6092h	2	U32		RW	no	Shaft revolutions	—
6098h	0	INT8		RW	no	Homing type	HOME.MODE , HOME.DIR
6099h		ARRAY				Homing velocity	—
6099h	0	U8		RO	no	highest sub-index	—
6099h	1	U32	1:1	RW	no	Speed while searching for limit switch	HOME.V
6099h	2	U32		RW	no	Speed while searching for zero mark	HOME. FEEDRATE
609Ah	0	U32	1:1	RW	no	Homing acceleration	HOME.ACC , HOME.DEC
60B1h	0	INT32	1:1	RW	yes*	Velocity offset	VL.BUSFF
60B2h	0	INT16		RW	yes*	Torque offset (PDO only)	—
60B8h	0	U16		RW	yes	Touch probe function	—
60B9h	0	U16		RW	yes	Touch probe status	—
60BAh	0	INT32		RW	yes	Touch probe 1 positive edge	—
60BBh	0	INT32		RW	yes	Touch probe 1 negative edge	—
60BCh	0	INT32		RW	yes	Touch probe 2 positive edge	—
60BDh	0	INT32		RW	yes	Touch probe 2 negative edge	—
60C0h	0	INT16		RW	no	Interpolation submode select	—
60C1h		ARRAY				Interpolation data record	—
60C1h	0	U8		RO	no	highest sub-index	—
60C1h	1	INT32		RW	yes*	Interpolation target position	—
60C1h	2	U32		RW	yes	Interpolation time	—
60C1h	3	INT32		RW	yes	Interpolation target velocity	—
60C2h		RECORD				Interpolation time period	—
60C2h	0	U8		RO	no	highest sub-index	FBUS. SAMPLEPERIOD
60C2h	1	U8		RW	no	Interpolation time units	—
60C2h	2	INT8		RW	no	Interpolation time index	—
60C4h		RECORD				Interpolation data configuration	—
60C4h	0	U8		RO	no	highest sub-index	—
60C4h	1	U32		RO	no	Maximum buffer size	—
60C4h	2	U32		RO	yes	Actual buffer size	—
60C4h	3	U8		RW	no	Buffer organization	—
60C4h	4	U16		RW	no	Buffer position	—
60C4h	5	U8		WO	no	Size of data record	—
60C4h	6	U8		WO	no	Buffer clear	—
60D0h		ARRAY				Touch probe source	—
60D0h	0	U8		RO	no	highest sub-index	-
60D0h	1	INT16		RW	no	Touch probe 1 source	—
60D0h	2	INT16		RW	no	Touch probe 2 source	—
60E0h	0	UINT16		RO	yes*	Positive torque limit value	IL.LIMITP
60E1h	0	UINT16		RO	yes*	Negative torque limit value	IL.LIMITN
60E4h		ARRAY				Additional position actual value	—

Index	Sub-index	Data Type	Float Scale	Access	PDO map.	Description	ASCII object
60E4h	0	U8		RO	no	highest sub-index	—
60E4h	1	INT32		RW	no	1st additional position actual value	—
60E4h	2	INT32		RW	no	reserved	—
60E4h	3	INT32		RW	no	3rd additional position actual value	—
60E8h		ARRAY				Additional gear ratio - motor shaft revolutions	—
60E8h	0	U8		RO	no	highest sub-index	—
60E8h	1	U32		RW	no	1st additional gear ratio - motor shaft revolutions	—
60E8h	2	U32		RW	no	reserved	—
60E8h	3	U32		RW	no	3rd additional gear ratio - motor shaft revolutions	—
60E9h		ARRAY				Additional feed constant - feed	—
60E9h	0	U8		RO	no	highest sub-index	—
60E9h	1	U32		RW	no	1st additional feed constant - feed	—
60E9h	2	U32		RW	no	reserved	—
60E9h	3	U32		RW	no	3rd additional feed constant - feed	—
60EDh		ARRAY				Additional gear ratio - driving shaft revolutions	—
60EDh	0	U8		RO	no	highest sub-index	—
60EDh	1	U32		RW	no	1st additional gear ratio - driving shaft revolutions	—
60EDh	2	U32		RW	no	reserved	—
60EDh	3	U32		RW	no	3rd additional gear ratio - driving shaft revolutions	—
60EEh		ARRAY				Additional feed constant - driving shaft revolutions	—
60EEh	0	U8		RO	no	highest sub-index	—
60EEh	1	U32		RW	no	1st additional feed constant - driving shaft revolutions	—
60EEh	2	U32		RW	no	reserved	—
60EEh	3	U32		RW	no	3rd additional feed constant - driving shaft revolutions	—
60F4h	0	INT32		RO	yes	Following error actual value	PL.ERR
60FCh	0	INT32		RO	yes	Position demand internal value	PL.CMD
60FDh	0	U32		RO	yes	Digital inputs	DIN1.MODE TO DIN6.MODE DIN1.MODE TO DIN3.MODE
60FEh		ARRAY				Digital outputs	
60FEh	0	U8		RO	no	highest sub-index	
60FEh	1	U32		RW	yes	Physical outputs	
60FEh	2	U32		RW	no	Bit mask	
60FFh	0	INT32	1000:1	RW	yes*	Target velocity	VL.CMDU
6502h	0	U32		RO	no	Supported drive modes	—

19.33.3 Object descriptions

The objects in this section are sorted by object number.

19.33.3.1 Object 1000h: Device Type (DS301)

This object describes the device type (servo drive) and device functionality (DS402 drive profile). Definition:

MSB				LSB			
Additional information				Device profile number			
Mode bits		Type		402d=192h			
31	24	23	16	15			0

The device profile number is DS402, the type is 2 for drives, the mode bits 28 to 31 are manufacturer specific and may be changed from its actual value of 0. A read access delivers 0x00020192 at the moment.

Index	1000h
Name	device type
Object code	VAR
Data type	UNSIGNED32
Category	mandatory
Access	R/O
PDO mapping	not possible
Value range	UNSIGNED32
Default value	no

19.33.3.2 Object 1001h: Error register (DS301)

This object is an error register for the device. The device can map internal errors into this byte. It is a part of an Emergency object.

Index	1001h
Name	Error register
Object code	VAR
Data type	UNSIGNED8
Category	mandatory
Access	R/O
PDO mapping	not possible
Value range	UNSIGNED8
Default value	no

Error reasons to be signaled: If a bit is set to 1 the specified error has occurred. The generic error is signaled at any error situation.

Bit	Description	Bit	Description
0	generic error	4	communication error (overrun, error state)
1	current	5	device profile specific
2	voltage	6	reserved (always 0)
3	temperature	7	manufacturer specific

19.33.3.3 Object 1002h: Manufacturer Status Register (DS301)

The manufacturer status register contains important drive informations.

Index	1002h
Name	Manufacturer Status Register
Object code	VAR
Data type	UNSIGNED32
Category	optional
Access	R/O
PDO mapping	possible
Value range	UNSIGNED32
Default value	no

The following table shows the bit assignment for the status register:

Bit	Description	Bit	Description
0	1 = Movement (positioning, homing) active	16	1 = Homing move active
1	reference position set	17	reserved
2	1 = reference switch high (home-position)	18	reserved
3	1 = In Position	19	1 = Emergency stop active
4	reserved	20	reserved
5	reserved	21	reserved
6	reserved	22	reserved
7	Active Disabel activated	23	1 = Homing move finished
8	Warning active	24	Power stage deactivating
9	1 = target velocity reached (pp- or pv-Mode)	25	1 = digital input 1 set
10	reserved	26	1 = digital input 2 set
11	1 = Homing error	27	1 = digital input 3 set
12	reserved	28	1 = digital input 4 set
13	1 = Safe Torque Off selected	29	1 = digital input hardware enable set
14	1 = Power stage enabled		
15	1 = Error state	31	Braking, 1 = set points not accepted

19.33.3.4 Object 1003h: Predefined Error Field (DS301)

The object 1003h provides an error history with a maximum size of 10 entries.

Subindex 0 contains the number of errors which have occurred since the last reset of the error history, either by startup of the drive or resetting the error history by writing 0 to subindex 0.

A new Emergency-message is written into subindex 1 shifting the old entries one subindex higher. The old content of subindex 8 is lost.

The UNSIGNED32-information written to the subindexes is defined in the field Error Code in the description of the Emergency Messages (→ p. 945).

Index	1003h
Name	pre-defined Error Field
Object code	ARRAY
Data type	UNSIGNED32
Category	optional
Subindex	0
Description	highest sub-index supported
Data type	UNSIGNED8
Category	mandatory
Access	R/W
PDO mapping	not possible
Value range	0 to 10
Default value	0
Subindex	1 to 10
Description	Standard error field (→ p. 945)
Category	optional
Access	R/O
PDO mapping	not possible
Value range	UNSIGNED32
Default value	no

19.33.3.5 Object 1005h: COB-ID of the SYNC Message (DS301)

This object defines the COB-Id of the synchronisation object (SYNC).

Index	1005h
Name	COB-ID for the SYNC message
Object code	VAR
Data type	UNSIGNED32
Category	conditional
Access	R/W
PDO mapping	not possible
Value range	UNSIGNED32
Default value	0x80

Bit coded information:

Bit	Value	Meaning
31 (MSB)	X	—
30	0	Device not generate SYNC message
	1	Device generates SYNC message
29	0	11 Bit ID (CAN 2.0A)
	1	29 Bit ID (CAN 2.0B)
28 to 11	X	—
	0	if Bit 29=0
10 to 0 (LSB)	X	Bit 0 to 10 of SYNC COB-ID

The device does not support the generation of SYNC-messages and only the 11-bit IDs. So the bits 11 to 30 are always 0.

19.33.3.6 Object 1006h: Communication Cycle Period (DS301)

This object can be used to define the period (in μ s) for the transmission of the SYNC telegram.

Index	1006h
Name	Period of the communication cycle
Object code	VAR
Data type	UNSIGNED32
Category	O
Access	R/W
PDO mapping	not possible
Value range	UNSIGNED32
Default value	00h

19.33.3.7 Object 1008h: Manufacturer Device Name (DS301)

The device name consists of four ASCII characters in the form Yzzz, whereby Y stands for the mains voltage (L, M, H or U, e.g. H for High Voltage) zzz stands for the power stage current.

Index	1008h
Name	Manufacturer Device Name
Object code	VAR
Data type	Visible String
Category	Optional
Access	const
PDO mapping	not possible
Value range	
Default value	no

19.33.3.8 Object 1009h: Manufacturer Hardware Version

This object will be supported in the future.

Index	1009h
Name	manufacturer hardware version
Object code	VAR
Data type	Visible String
Category	Optional
Access	const
PDO mapping	not possible
Value range	-
Default value	no

19.33.3.9 Object 100Ah: Manufacturer Software Version (DS301)

The object contains the manufacturer software version (here: the CANopen-part of the drive firmware).

Index	100Ah
Name	Manufacturer Software Version
Object code	VAR
Data type	Visible String
Category	Optional
Access	const
PDO mapping	not possible
Value range	0.01 to 9.99
Default value	no

19.33.3.10 Object 100Ch: Guard Time (DS301)Response monitoring

The arithmetical product of the Objects 100Ch Guard Time and 100Dh Lifetime Factor is the response monitoring time. The Guard Time is given in milliseconds. The response monitoring is activated with the first Nodeguard object. If the value of the object Guard Time is set to zero, then the response monitoring is inactive.

Index	100Ch
Name	Guard Time
Object code	VAR
Data type	UNSIGNED16
Category	conditional; mandatory, if heartbeat not supported
Access	R/W
PDO mapping	not possible
Value range	UNSIGNED16
Default value	0

19.33.3.11 Object 100Dh: Lifetime Factor (DS301)

The product of Guard Time and Life Time Factor gives the life time for the nodeguarding protocol. If it's 0, the protocol is not used.

Index	100Dh
Name	Lifetime Factor
Object code	VAR
Data type	UNSIGNED8
Category	conditional; (mandatory, if heartbeat not supported)
Access	R/W
PDO mapping	not possible
Value range	UNSIGNED8
Default value	0

19.33.3.12 Object 1010h: Store Parameters (DS301)

This object supports the saving of parameters to a flash EEPROM. Only the subindex 1 for saving of all parameters, which can also be saved in the parameter files via the GUI, is supported.

Index	1010h
Name	store parameters (DRV.NVSAVE)
Object code	ARRAY
Data type	UNSIGNED32
Category	optional
Subindex	0
Name	highest sub-index supported
Object code	VAR
Data type	UNSIGNED8
Category	mandatory
Access	R/O
PDO Mapping	not possible
Value range	1
Default value	1
Subindex	1
Name	save all parameters
Object code	VAR
Data type	UNSIGNED32
Category	mandatory
Access	R/W
PDO Mapping	not possible
Value range	UNSIGNED32
Default value	1

Data definition:

Bit	Value	Meaning
31 to 2	0	reserved (=0)
1	0	Device does not save parameters autonomously
	1	Device does save parameters autonomously
0	0	Device does not save parameters on command
	1	Device does save parameters on command

By read access to subindex 1 the drive provides information about its storage functionality.

This drive provides a constant value of 1 by read access, i.e. all parameters can be saved by writing to Object 1010 sub 1. In general the drive does not save parameters autonomously with the exception of e.g. the special treatment of the homing of multiturn absolute encoders.

Storing of parameters is only done if a special signature ("save") is written to subindex 1. "save" is equivalent to the unsigned32 - number 65766173h.

19.33.3.13 Object 1011h: Restore Default Parameters DS301

With this object the default values of parameters according to the communication or device profile are restored. The AKD PDMM gives the possibility to restore all default values.

Index	1011h
Name	restore default parameters
Object code	ARRAY
Data type	UNSIGNED32
Category	optional
Subindex	0
Name	highest sub-index supported
Object code	VAR
Data type	UNSIGNED8
Category	mandatory
Access	R/O
PDO Mapping	not possible
Value range	1
Default value	1
Subindex	1
Name	restore all default parameters (DRV.RSTVAR)
Object code	VAR
Data type	UNSIGNED32
Category	mandatory
Access	R/W
PDO Mapping	not possible
Value range	UNSIGNED32
Default value	1 (device restores parameter)

Restoring default parameters to the RAM will be done, if a special signature ("load") is written to subindex 1. "load" has to be transmitted as unsigned32 - number 64616F6Ch.

19.33.3.14 Object 1012h: COB-ID of the Time Stamp (DS301)

This object defines the COB-ID of the time stamp.

Index	1012h
Name	COB-ID for the time stamp
Object code	VAR
Data type	UNSIGNED32
Category	optional
Access	R/W
PDO mapping	not possible
Value range	UNSIGNED32
Default value	100h

Bit coded information:

Bit	Content	Value	Meaning
31 (MSB)	consume	0	Drive does not consume time message
		1	Drive does consume time message
30	produce	0	Drive does not produce time message
		1	Drive does produce time message
29	frame	0	Value fixed to 0
28 to 11	reserved	–	reserved
10 to 0 (LSB)	CAN-ID	0h - 800h	COB-ID of the time stamp

19.33.3.15 Object 1014h: COB-ID for Emergency Message (DS301)

This object defines the COB-ID of the Emergency message.

Index	1014h
Name	COB-ID emergency message
Object code	VAR
Data type	UNSIGNED32
Category	conditional; mandatory, if Emergency is supported
Access	R/O
PDO mapping	not possible
Value range	UNSIGNED32
Default value	80h + Node - ID

19.33.3.16 Object 1016h: Consumer Heartbeat Time

The consumer heartbeat time defines the expected heartbeat cycle time (ms) and must be higher than the corresponding producer heartbeat time configured on the device producing this heartbeat. Monitoring starts after the reception of the first heartbeat. If the consumer heartbeat time is 0 ms the corresponding entry is not used.

Index	1016h
Name	consumer heartbeat time
Object code	ARRAY
Data type	UNSIGNED32
Category	optional
Subindex	0
Description	highest sub-index supported
Data type	UNSIGNED8
Category	mandatory
Access	R/O
PDO Mapping	not possible
Value range	1
Default value	1
Subindex	1
Description	Consumer heartbeat time
Category	mandatory
Access	R/W
PDO Mapping	not possible
Value range	unsigned 32
Default value	0

Definition of the entry value of Subindex 1

	MSB			LSB	
Value	reserved (value: 00)		Node-ID		heartbeat time
Encoded as	-		UNSIGNED8		UNSIGNED16
Bit	31	24	23	16	15 0

19.33.3.17 Object 1017h: Producer Heartbeat Time

The producer heartbeat time defines the cycle time of the heartbeat in ms. If it's 0, it is not used.

Index	1017h
Name	Producer heartbeat time
Object code	VAR
Data type	UNSIGNED16
Category	conditional; mandatory, if guarding is not supported
Access	R/W
PDO mapping	not possible
Value range	UNSIGNED16
Default value	0

19.33.3.18 Object 1018h: Identity Object (DS301)

The Identity Object contains general device information.

Index	1018h
Name	Identity Object
Object code	RECORD
Data type	Identity
Category	mandatory
Subindex	0
Description	highest sub-index supported
Data type	UNSIGNED8
Category	mandatory
Access	R/O
PDO mapping	not possible
Value range	1 to 4
Default value	4

Subindex 1 is a unique number for a device manufacturer.

Subindex	1
Description	Vendor ID
Category	mandatory
Access	R/O
PDO mapping	not possible
Value range	UNSIGNED32
Default value	0x6Ah (Kollmorgen)

Subindex 2 contains four ASCII - characters, which determine the voltage range and current class of the device. The voltage range is one character L, M or H for low, medium and high voltage. The next three characters are showing the continuous current of the drive.

Subindex	2
Description	Product Code
Category	optional
Access	R/O
PDO mapping	not possible
Value range	e.g. M006 for an MV6 drive
Default value	no

Subindex 3 consists of two revision numbers:

- the major revision number in the upper word containing the CAN-version
- the minor revision number is not used in the AKD PDMM. The firmware version can be retrieved as a string via object 0x100A or as numbers via object 0x2018 subindex 1 to 4.

E.g. a value of 0x0014 0000 means CAN-version 0.20.

Subindex	3
Description	Revision Number
Category	optional
Access	R/O
PDO mapping	not possible
Value range	UNSIGNED32
Default value	no

Subindex 4 gives the serial number of the drive. This number contains the following information in it:

- bits 0..14: Board serial number (production in week of year)
- bits 15..20: week of production
- bits 21..24: year of production - 2009
- bits 25..31: ASCII-code of MFR-ID

Subindex	4
Description	Serial Number
Category	optional
Access	R/O
PDO mapping	not possible
Value range	UNSIGNED32
Default value	no

19.33.3.19 Object 1026h: OS Prompt

The OS prompt is used to build up an ASCII - communication channel to the drive.

Index	1026h
Name	OS Prompt
Object code	ARRAY
Data type	UNSIGNED8
Category	optional
Subindex	0
Description	highest sub-index supported
Data type	UNSIGNED8
Category	mandatory
Access	R/O
PDO mapping	not possible
Value range	2
Default value	2

Subindex 1 is used to send one character to the drive.

Subindex	1
Description	StdIn
Category	mandatory
Access	W
PDO mapping	not possible
Value range	UNSIGNED8
Default value	—

Subindex 2 is used to receive one character from the drive.

Subindex	2
Description	StdOut
Category	mandatory
Access	R/O
PDO mapping	not possible
Value range	UNSIGNED8
Default value	0

19.33.3.20 Objects 1400-1403h: 1st - 4th RxPDO communication parameter (DS301)

1400h to 1403h for RxPDO 1 to 4

Index	1400h 1401h 1402h 1403h
Name	receive PDO parameter
Object code	RECORD
Data type	PDO CommPar
Category	mandatory

Defined sub-indices

Subindex	0	
Name	highest sub-index supported	
Data type	UNSIGNED8	
Category	mandatory	
Access	R/O	
PDO Mapping	not possible	
Value Range	2	
Default Value	2	
Subindex	1	
Name	COB-ID used by PDO	
Category	mandatory	
Access	R/W	
PDO Mapping	not possible	
Value Range	UNSIGNED32	
Default Value	Index 1400h: 200h + Node-ID Index 1402h: 400h + Node-ID	Index 1401h: 300h + Node-ID Index 1403h: 500h + Node-ID

Subindex 1 contains the COB-Id of the PDO as a bit coded information:

Bit	Value	Meaning
31	0	PDO exists/is valid
	1	PDO does not exist/is not valid
30	0	RTR allowed on this PDO, not to be used (Can in Automation organisation)
	1	RTR not allowed on this PDO
29	0	11 bit-ID (CAN 2.0A)
	1	29 bit-ID (CAN 2.0B), not supported
28 to 11	X	Identifier-bits with 29 bit-ID, not relevant
10 to 0	X	Bits 10-0 of COB-ID

Subindex	2
Name	transmission type
Category	mandatory
Access	R/W
PDO Mapping	not possible
Value Range	UNSIGNED8
Default Value	FFh

Subindex 2 contains the transmission type of the PDO. There are two ways of setting:

- the value FFh or 255 for event-triggered PDO, which is directly interpreted by reception and taken into actions,
- values from 0 to 240, which cause a SYNC-telegram-controlled interpretation of the PDO contents. Values of 1 to 240 mean, that 0 to 239 SYNC-telegrams are ignored, before one is interpreted. The value 0 means, that only the next SYNC-telegram is interpreted.

19.33.3.21 Objects 1600-1603h: 1st - 4th RxPDO mapping parameter (DS301)

1600h to 1603h for RxPDO 1 to 4.

Index	1600h 1601h 1602h 1603h
Name	receive PDO mapping
Object Code	RECORD
Data Type	PDO Mapping
Category	mandatory
Subindex	0
Name	highest sub-index supported
Data type	UNSIGNED8
Category	mandatory
Access	R/W
PDO Mapping	not possible
Value Range	0: PDO is not active 1 - 8: PDO activated, mappings are taken only byte-wise
Default Value	PDO1: 1 PDO2: 2 PDO3: 2 PDO4: 2
Subindex	1 - 8
Name	PDO - mapping for the n-th application object
Category	Conditional, depends on number and size of object be mapped
Access	R/W
PDO Mapping	not possible
Value Range	UNSIGNED32

Default Value	See below
---------------	-----------

19.33.3.22 Objects 1800-1803h: 1st - 4th TxPDO communication parameter (DS301)

1800h to 1803h for TxPDO 1 to 4.

Index	1800h 1801h 1802h 1803h
Name	transmit PDO parameter
Object code	RECORD
Data type	PDO CommPar
Category	mandatory
Subindex	0
Name	highest sub-index supported
Data type	UNSIGNED8
Category	mandatory
Access	R/O
PDO Mapping	not possible
Value Range	5
Default Value	5
Subindex	1
Name	COB-ID used by PDO
Category	mandatory
Access	R/W
PDO Mapping	not possible
Value Range	UNSIGNED32
Default Value	Index 1800h: 180h + Node-ID Index 1801h: 280h + Node-ID Index 1802h: 380h + Node-ID Index 1803h: 480h + Node-ID
Subindex	2
Name	transmission type
Category	mandatory
Access	R/W
PDO Mapping	not possible
Value Range	UNSIGNED8
Default Value	FFh
Subindex	3
Name	inhibit time
Category	optional
Access	R/W
PDO Mapping	not possible
Value Range	UNSIGNED16 (n*1/10ms)
Default Value	0h

Subindex	4
Name	reserved
Category	optional
Access	R/W
PDO Mapping	not possible
Value Range	0
Default Value	0

Subindex	5
Name	event timer
Category	optional
Access	R/W
PDO Mapping	not possible
Value Range	UNSIGNED16 (0=not used, ms)
Default Value	0h

Subindex 1 contains the COB-Id of the PDO as a bit coded information:

Bit-Number	Value	Meaning
31	0	PDO exists/is valid
	1	PDO does not exist/is not valid
30	0	RTR allowed on this PDO, not supported
	1	RTR not allowed on this PDO, not supported
29	0	11 bit-ID (CAN 2.0A)
	1	29 bit-ID (CAN 2.0B), not supported
28 to 11	X	Identifier-bits with 29 bit-ID, not relevant
10 to 0	X	Bits 10-0 of COB-ID

Subindex 2 contains the transmission type of the PDO. There are two ways of setting:

- A value of FFh or 255d for an event-triggered PDO, which is sent immediately after a change in the mapped application objects. Setting of Subindex 3 or 5 has an influence on the sending of a PDO. With Subindex 3 you can configure, in which minimal time the so configured Transmit-PDOs are sent, if PDO-data contents change (reduction of bus-load). With Subindex 5 (event time) a timer is used, which is reset with every event-triggered sending of this PDO. If there is no change of the PDO-content in this time, the PDO is sent caused by this timer event.
- Values from 0 to 240 cause a SYNC-Telegram controlled sending of the PDO.
- Values from 1 to 240 define how often the SYNC-telegram leads to a sending of a PDO.
- The value 0 means, that only the next SYNC-telegram leads to a sending of the so configured PDOs.

19.33.3.23 Objects 1A00-1A03h: 1st - 4th TxPDO mapping parameter (DS301)

1A00h to 1A03h for TxPDO 1 to 4.

Index	1A00h 1A01h 1A02h 1A03h
Name	transmit PDO mapping
Object Code	RECORD
Data Type	PDO Mapping
Category	mandatory
Subindex	0
Name	number of mapped application objects in PDO
Data type	UNSIGNED8
Category	mandatory
Access	R/W
PDO Mapping	not possible
Value Range	0: PDO is not active 1 - 8: PDO activated, mappings are taken only byte-wise
Default Value	PDO1: 1 PDO2: 2 PDO3: 2 PDO4: 2
Subindex	1 - 8
Name	PDO - mapping for the n-th application object
Category	Conditional, depends on number and size of object be mapped
Access	R/W
PDO Mapping	not possible
Value Range	UNSIGNED32
Default Value	See below

19.33.3.24 Object 1C12h: RxPDO assign (DS301)

This object is used to define the mapping for receive direction of EtherCAT data. Either one of the fixed RxPDO mappings 1701h to 1724h is chosen or 1 to 4 of the free mappings 1600h to 1603h.

Index	1C12h
Name	RxPDO assign
Object code	ARRAY
Data type	UNSIGNED16
Category	optional

Defined sub-indices

Subindex	0
Name	highest sub-index supported
Data type	UNSIGNED8
Category	mandatory
Access	R/W
PDO Mapping	not possible
Value Range	0: pdo not active, 1-4 PDO activated
Default Value	1

Subindex	1 to 4
Name	Subindex 001..004
Data type	UNSIGNED8
Category	optional
Access	R/W
PDO Mapping	not possible
Value Range	UNSIGNED16
Default Value	1701h via ESI-file

19.33.3.25 Object 1C13h: TxPDO assign (DS301)

This object is used to define the mapping for transmit direction of EtherCAT data. Either one of the fixed TxPDO mappings 1B01h to 1B25h is chosen or 1 to 4 of the free mappings 1A00h to 1A03h.

Index	1C13h
Name	TxPDO assign
Object code	ARRAY
Data type	UNSIGNED16
Category	optional

Defined sub-indices

Subindex	0
Name	highest sub-index supported
Data type	UNSIGNED8
Category	mandatory
Access	R/O
PDO Mapping	not possible
Value Range	0: pdo not active, 1-4 PDO activated
Default Value	1

Subindex	1 to 4
Name	Subindex 001..004
Data type	UNSIGNED16
Category	optional
Access	R/W
PDO Mapping	not possible
Value Range	UNSIGNED16
Default Value	1B01h via ESI-file

19.33.3.26 Object 2000h: System Warnings

This object is used to show up to three actual warnings with their AKD PDMM- specific warning number.

Index	2000h
Name	System Warnings
Object code	ARRAY
Data type	UNSIGNED32
Subindex	0
Description	highest sub-index supported
Category	mandatory
Access	R/O
PDO mapping	not possible
Value range	3
Default value	3
Subindex	1 to 3
Description	DRV.WARNING1 to DRV.WARNINGS3
Mode	independent
Access	R/O
PDO mapping	not possible
Unit	—
Value range	0 to 999
Default value	0

19.33.3.27 Object 2001h: System Faults

This object is used to show up to ten actual faults with their AKD PDMM- specific fault number.

Index	2001h
Name	System Faults
Object code	ARRAY
Data type	UNSIGNED32
Subindex	0
Description	highest sub-index supported
Category	mandatory
Access	R/O
PDO mapping	not possible
Value range	0xA
Default value	0xA
Subindex	1 to A
Description	DRV.FAULT1 to DRV.FAULT10
Mode	independent

Access	R/O
PDO mapping	not possible
Unit	—
Value range	0 to 999
Default value	0

19.33.3.28 Object 2002h: Manufacturer status bytes

This object delivers the information of the manufacturer status (object 0x1002 sub 0) as four separate, mappable, bytes.

Index	2002h
Name	Manufacturer status bytes
Object code	ARRAY
Data type	UNSIGNED8
Subindex	0
Description	highest sub-index supported
Category	mandatory
Access	R/O
PDO mapping	not possible
Value range	0x4
Default value	0x4
Subindex	1 to 4
Description	Manufacturer status byte 1 to Manufacturer status byte 4
Mode	independent
Access	R/O
PDO mapping	possible
Unit	—
Value range	0 to 0xFF
Default value	-

19.33.3.29 Object 2011h: DRV.RUNTIME in seconds

This object delivers the runtime of the drive in seconds.

Index	2011h
Name	DRV.RUNTIME in seconds
Object code	VAR
Data type	UNSIGNED32
Access	R/O
Unit	—
Value range	UNSIGNED32
Default value	0

19.33.3.30 Object 2012h: Fault history: Fault numbers

This object delivers the 20 latest entries of the fault numbers of the fault history table. The latest event can be read via sub-index 1. With new events the list is shifted to higher sub-indices.

Index	2012h
Name	Fault history: Fault numbers
Object code	ARRAY
Data type	UNSIGNED32
Subindex	0
Description	highest sub-index supported
Category	mandatory
Access	R/O
PDO mapping	not possible
Value range	0x14h
Default value	0x14h
Subindex	1 to 20
Description	Nth-latest entry in fault number list of fault history table (DRV.FAULHIST)
Mode	independent
Access	R/O
PDO mapping	not possible
Unit	—
Value range	0 - 999
Default value	0

19.33.3.31 Object 2013h: Fault history: Time stamps

This object delivers the 20 latest entries of the fault time stamps of the fault history table in seconds related to DRV.RUNTIME. The latest event can be read via sub-index 1. With new events the list is shifted to higher sub-indices.

Index	2013h
Name	Fault history: Time stamps
Object code	ARRAY
Data type	UNSIGNED32
Subindex	0
Description	highest sub-index supported
Category	mandatory
Access	R/O
PDO mapping	not possible
Value range	0x14h
Default value	0x14h
Subindex	1 to 20
Description	Nth-latest entry in fault time stamp list of fault history table (DRV.FAULTHIST)
Mode	independent
Access	R/O
PDO mapping	not possible
Unit	—
Value range	UNSIGNED32
Default value	—

19.33.3.32 Object 2014-2017h: 1st-4th Mask 1 to 4 for Transmit-PDO

In order to reduce the bus loading with event-triggered PDOs, masking can be used to switch off the monitoring for individual bits in the PDO. In this way it can be arranged, for instance, that actual position values are only signaled once per turn.

This Object masks the PDO-channels 1 to 4. If only two bytes have been defined in a PDO, then it masks just two bytes, although 4 bytes of mask information have been transmitted.

An activated bit in the mask means that monitoring is active for the corresponding bit in the PDO.

Index	2014h 2015h 2016h 2017h
Name	tx_mask 1 to 4
Object code	ARRAY
Data type	UNSIGNED32
Subindex	1
Description	tx_mask1 to 4_low
Mode	independent
Access	R/W
PDO mapping	not possible
Unit	—
Value range	UNSIGNED32
Default value	FFFFFFFFh
Subindex	2
Description	tx_mask1 to 4_high
Mode	independent
Access	R/W
PDO mapping	not possible
Unit	—
Value range	UNSIGNED32
Default value	FFFFFFFFh

19.33.3.33 Object 2018h: Firmware Version

This object gives all information regarding the firmware version.

Example: Firmware version M_01_00_01_005 would show the numbers 1, 0, 1, 5 in the sub-indices 1 to 4.

Index	2018h
Name	firmware version
Object code	ARRAY
Data type	UNSIGNED16
Subindex	1
Description	major version
Mode	independent
Access	R/O
PDO mapping	not possible
Unit	—
Value range	UNSIGNED16
Default value	0
Subindex	2
Description	minor version
Mode	independent
Access	R/O
PDO mapping	not possible
Unit	—
Value range	UNSIGNED16
Default value	0
Subindex	3
Description	revision
Mode	independent
Access	R/O
PDO mapping	not possible
Unit	—
Value range	UNSIGNED16
Default value	0
Subindex	4
Description	branch revision
Mode	independent
Access	R/O
PDO mapping	not possible
Unit	—
Value range	UNSIGNED16
Default value	0

19.33.3.34 Object 2026h: ASCII Channel

This object is used to build up an ASCII - communication channel to the drive with 4-byte ASCII-strings.

Index	2026h
Name	ASCII Channel
Object code	ARRAY
Data type	Visible String
Category	optional
Subindex	0
Description	highest sub-index supported
Data type	UNSIGNED8
Category	mandatory
Access	R/O
PDO mapping	not possible
Value range	2
Default value	2

Subindex 1 is used to send four ASCII-characters to the drive.

Subindex	1
Description	Command
Category	mandatory
Access	wo
PDO mapping	no
Value range	Visible String
Default value	—

Subindex 2 is used to receive four characters from the drive.

Subindex	2
Description	Response
Category	mandatory
Access	R/O
PDO mapping	no
Value range	Visible String
Default value	-

19.33.3.35 Object 204Ch: PV Scaling Factor

This object shall indicate the configured numerator and denominator of the pv scaling factor. The pv scaling factor serves to modify the resolution or directing range of the specified setpoint. It is also included in calculation of the vl velocity demand, and vl velocity actual value. It does not influence the velocity limit function and the ramp function. The value shall have no physical unit and shall be given in the range from -32 768 to +32 767, but the value of 0 shall not be used.

The velocity scaling factor is only active, when bit 4 of FBUS.PARAM05 is set to 1. Otherwise velocities are scaled as 1/1000 rpm.

Index	204Ch
Name	pv scaling factor
Object code	ARRAY
Data type	INTEGER32
Category	optional
Subindex	0
Description	highest sub-index supported
Data type	UNSIGNED8
Category	mandatory
Access	R/O
PDO mapping	not possible
Value range	2
Default value	no
Subindex	1
Description	pv scaling factor numerator
Category	optional
Access	R/W
PDO mapping	not possible
Value range	INTEGER32
Default value	+1
Subindex	2
Description	pv scaling factor denominator
Category	optional
Access	R/W
PDO mapping	not possible
Value range	INTEGER32
Default value	+1

19.33.3.36 Object 2071h: Target Current

This parameter can be used alternatively to the DS402 parameter 6071h and is the input to the torque controller. The value is scaled in mA (milli Amperes).

Index	2071h
Name	Target current
Object code	VAR
Data type	INTEGER 32
Category	optional
Access	RW
PDO mapping	possible
Value range	depends on DRV.IPEAK and MOTOR.IPEAK
Default value	0

19.33.3.37 Object 2077h: Current Actual Value

This parameter can be used alternatively to the DS402 parameter 6077h. The value is scaled in mA (milli Amperes).

Index	2077h
Name	Current actual value
Object code	VAR
Data type	INTEGER 32
Category	optional
Access	RO
PDO mapping	possible
Value range	depends on DRV.IPEAK and MOTOR.IPEAK
Default value	0

19.33.3.38 Object 20A0h: Latch position 1, positive edge

This object is used to output the position or a time, depending on CAP0.MODE, at which the first positive edge occurred on a signal, which can be configured with CAP0.TRIGGER. The latch enable must be active for that purpose(see object 20A4 and 20A5). With CAP0.MODE = 3 the latched position of the encoder index pulse is transferred via this object.

Index	20A0h
Name	Latch position 1 positive edge CAP0.PLFB, Time capture CAP0.T
Object code	VAR
Data type	INTEGER32
Category	optional
Access	R/O
PDO mapping	possible
Value range	INTEGER32
Float scaling	var
Default value	0

19.33.3.39 Object 20A1h: Latch position 1, negative edge

This object is used to output the position or a time, depending on CAP0.MODE, at which the first negative edge occurred on a signal, which can be configured with CAP0.TRIGGER. The latch enable must be active for that purpose(see object 20A4 and 20A5).

Index	20A1h
Name	Latch position 1 negative edge CAP0.PLFB, Time capture CAP0.T
Object code	VAR
Data type	INTEGER32
Category	optional
Access	R/O
PDO mapping	possible
Value range	INTEGER32
Float scaling	var
Default value	0

19.33.3.40 Object 20A2h: Latch position 2, positive edge

This object is used to output the position or a time, depending on CAP1.MODE, at which the first positive edge occurred on a signal, which can be configured with CAP1.TRIGGER. The latch enable must be active for that purpose(see object 20A4 and 20A5).

Index	20A2h
Name	Latch position 2 positive edge CAP1.PLFB, Time capture CAP1.T
Object code	VAR
Data type	INTEGER32
Category	optional
Access	R/O
PDO mapping	possible
Value range	INTEGER32
Float scaling	var
Default value	0

19.33.3.41 Object 20A3h: Latch position 2, negative edge

This object is used to output the position or a time, depending on CAP1.MODE, at which the first negative edge occurred on a signal, which can be configured with CAP1.TRIGGER. The latch enable must be active for that purpose(see object 20A4 and 20A5).

Index	20A3h
Name	Latch position 2 negative edge CAP1.PLFB, Time capture CAP1.T
Object code	VAR
Data type	INTEGER32
Category	optional
Access	R/O
PDO mapping	possible
Value range	INTEGER32
Float scaling	var
Default value	0

19.33.3.42 Object 20A4h: Latch Control Register

The latch control register is used to enable the latch monitoring of the capture engines 0 and 1. The latch is enabled with a 1 signal and disabled with a 0 signal. Whether or not a latch event has occurred can be recognised by the latch status register (object 20A5).

Index	20A4h
Name	Latch Control Register
Object code	VAR
Data type	UNSIGNED16
Category	optional
Access	rww
PDO mapping	possible
Value range	0 to 15
Default value	0

Bit	Value (bin)	Value (hex)	Description
0	00000000 00000001	xx01	Enable extern latch 1 (positive rise)
1	00000000 00000010	xx02	Enable extern latch 1 (negative rise)
2	00000000 00000100	xx04	Enable extern latch 2 (positive rise)
3	00000000 00001000	xx08	Enable extern latch 2 (negative rise)
4 to 7			Reserve
8	00000001 00000000	01xx	Read external latch 1 (positive rise)
9	00000010 00000000	02xx	Read external latch 1 (negative rise)
10	00000011 00000000	03xx	Read external latch 2 (positive rise)
11	00000100 00000000	04xx	Read external latch 2 (negative rise)
12 to 15			Reserve

19.33.3.43 Object 20A5h: Latch Status Register

The latch status register is used to look for the states of the capture engines 0 and 1.

Index	20A5h
Name	Latch Status Register
Object code	VAR
Data type	UNSIGNED16
Category	optional
Access	rwr
PDO mapping	possible
Value range	-
Default value	0

Bit	Value (bin)	Value (hex)	Description
0	00000000 00000001	zz01	External latch 1 valid (positive rise)
1	00000000 00000010	zz02	External latch 1 valid (negative rise)
2	00000000 00000100	zz04	External latch 2 valid (positive rise)
3	00000000 00001000	zz08	External latch 2 valid (negative rise)
4 to 7			Reserve
8	00000001 00000000	z1zz	Acknowledge value external latch 1 (positive rise)
9	00000010 00000000	z2zz	Acknowledge value external latch 1 (negative rise)
10	00000011 00000000	z3zz	Acknowledge value external latch 2 (positive rise)
11	00000100 00000000	z4zz	Acknowledge value external latch 2 (negative rise)
12	00010000 00000000	1zzz	State Digital Input 4
13	00100000 00000000	2zzz	State Digital Input 3
14	01000000 00000000	4zzz	State Digital Input 2
15	10000000 00000000	8zzz	State Digital Input 1

19.33.3.44 Object 20A6h: Latch position 1, positive or negative edge

This object is used to output the position or a time, depending on CAP0.MODE, at which the first positive or negative edge occurred on a signal, that can be configured with CAP0.TRIGGER. Latch enable must be active for that purpose (see object 20A4 and 20A5).

Index	20A6h
Name	Latch position 1 positive or negative CAP0.PLFB
Object code	VAR
Data type	INTEGER32
Category	optional
Access	ro
PDO mapping	possible
Value range	INTEGER32
Float scaling	var
Default value	0

19.33.3.45 Object 20A7h: Latch position 2, positive or negative edge

This object is used to output the position or a time, depending on CAP1.MODE, at which the first positive or negative edge occurred on a signal, that can be configured with CAP1.TRIGGER. Latch enable must be active for that purpose (see object 20A4 and 20A5).

Index	20A7h
Name	Latch position 2 positive or negative CAP1.PLFB
Object code	VAR
Data type	INTEGER32
Category	optional
Access	ro
PDO mapping	possible
Value range	INTEGER32
Float scaling	var
Default value	0

19.33.3.46 Object 20B8h: Reset of changed input information

This object is used in PDOs to reset the state change information for the digital inputs shown in the Bits 24 to 30 in the object 60FD. Bit 0 to 6 are used to reset the information of the digital input 1 to 7.

Index	20B8h
Name	Reset of changed input information
Object code	VAR
Data type	UNSIGNED16
Category	optional
Access	rw
PDO mapping	possible
Value range	UNSIGNED16
Default value	0

19.33.3.47 Object 345Ah: Brake Control

These objects implement the possibility to control the brake directly, overriding the drive logic. When the brake state is controlled by the fieldbus, the drive state (enabled, disabled, faulted) will have no effect on the brake - the fieldbus will be in control.



CAUTION

Applying or releasing the brake at the wrong time can be a safety hazard and can destroy your mechanic as well as drive or motor. Unexpected behaviour might be possible. It is the responsibility of the customer using this mode to use this function appropriately.

When fieldbus control is disabled, the drive will control the brake as defined by existing AKD PDMM brake related parameters. As soon as fieldbus control is enabled, the Brake Command received over the field bus will take effect. So, if the Brake Command is set to APPLY and the current state is RELEASE, the brake will begin to apply .

The default value of the fieldbus control will be disabled, so that the drive is always in control until the fieldbus is operational. It is recommended that this bit remain 0 except for special operating conditions where the fieldbus will control the brake. When fieldbus communication is lost, the drive will regain control of the brake if the fieldbus had previously taken control.

Enable Fieldbus Control	Serious Failure condition present	Brake Command	Fieldbus Control Status	Controlled by...	Final Brake State
0	x	x	0	Drive	Drive
1*	no	0	1	Fieldbus	Applied
1*	no	1	1	Fieldbus	Released
x	yes	any	0	Drive	Drive

1* indicates that a rising edge was seen since the last time the drive applied the brake

Index	345Ah
Name	Brake Control
Object code	ARRAY
Data type	UNSIGNED16
Category	optional

Defined sub-indices

Subindex	0
Name	highest sub-index supported
Data type	UNSIGNED8
Category	mandatory
Access	R/O
PDO Mapping	not possible
Value Range	2
Default Value	2

Subindex	1
Name	Brake Control Command
Category	optional
Access	R/W
PDO Mapping	possible
Value Range	UNSIGNED16
Default Value	0

With subindex 1 the brake is controlled. Bit definition:

Bit	Name	Description
0	Enable fieldbus control	0 - brake is not controlled via this object 1 - enable fieldbus control via this object. This function works edge triggered, i.e. this bit has to have a 0 -> 1 transition to activate the brake control functionality. After a fault the functionality is reset and has to be activated again. The activation can be controlled by subindex 2 bit 0.
1	Brake Command	This command bit is only active, if the functionality was activated via bit 0. The function is as follows: 0 - apply the brake 1 - release the brake

Subindex	2
Name	Brake Status Response
Category	optional
Access	R/O
PDO Mapping	possible
Value Range	UNSIGNED16
Default Value	0

With subindex 2 the brake status can be checked. Bit definition:

Bit	Name	Description
0	Fieldbus control Status	0 - brake control via 0x345A is disabled or not possible due to drive failure. 1 - enable fieldbus control via this object. This function works edge triggered, i.e. this bit has to have a 0 -> 1 transition to activate the brake control functionality. After a fault the functionality is reset and has to be activated again. The activation can be controlled by subindex 2 bit 0.
1	Brake Status	0 - apply the brake 1 - release the brake Note: When the brake is applied or released, there is a time delay MOTOR.TBRAKEAPP or MOTOR.TBRAKEREL, after the receipt of the command before this status bit changes. The status is always reported: it is not affected by fieldbus control.

2	STO Status	0 - STO is not active (drive may be enabled) 1 - STO is active (drive can not be enabled)
3	HW Enable Status	0 - HW enable is disabled, drive function can not be enabled 1 - HW enable is enabled, drive function can be enabled

19.33.3.48 Object 3474h: Parameters for digital inputs

This set of objects is used to set extended parameters for some digital input functions. The parameters can be used for different DINx.MODEs. Therefore the scaling might be different or no scaling is used at all.

Two subindices build an access object to one of these parameters, because they are 64-bit numbers internally, e.g. object 3474 sub 1 gives access to the low 32 bits of DIN1.PARAM whereas 3474 sub 8 sub 4 gives access to the high 32 bits.

If access to the whole 64 bit number is needed the higher bits must be written first. The access to the lower 32 bits then writes the parameter. If the to be written value fits into 32 bit, only the lower part needs to be written. The most-significant bit is then taken as sign-bit for the number.

Index	3474h
Name	DINx.PARAM
Object code	Array
Data type	UNSIGNED32
Category	optional
Subindex	0
Description	highest sub-index supported
Category	mandatory
Access	R/O
PDO mapping	not possible
Value range	0xE
Default value	0xE
Subindex	1 to 7 1 to 3
Description	DINx.PARAM low 32 bits, x = 1 .. 7 1 .. 3
Category	optional
Access	R/W
PDO mapping	not possible
Value range	UNSIGNED32
Default value	0
Subindex	8 to 0xE 4 to 6
Description	DINx.PARAM high 32 bits, x = 1 .. 7 1 .. 3
Category	optional
Access	R/W
PDO mapping	not possible
Value range	UNSIGNED32
Default value	0

19.33.3.49 Object 3475h: Parameters for digital outputs

This set of objects is used to set extended parameters for some digital output functions. The parameters can be used for different DOUTx.MODEs. Therefore the scaling might be different or no scaling is used at all.

Two subindices build an access object to one of these parameters, because they are 64-bit numbers internally, e.g. object 3475 sub 1 gives access to the low 32 bits of DOUT1.PARAM whereas 3475 sub 32 gives access to the high 32 bits.

If access to the whole 64 bit number is needed the higher bits must be written first. The access to the lower 32 bits then writes the parameter. If the to be written value fits into 32 bit, only the lower part needs to be written. The most-significant bit is then taken as sign-bit for the number.

Index	3475h
Name	DOUTx.PARAM
Object code	Array
Data type	UNSIGNED32
Category	optional
Subindex	0
Description	highest sub-index supported
Category	mandatory
Access	R/O
PDO mapping	not possible
Value range	0x4
Default value	0x4
Subindex	1 to 2
Description	DOUTx.PARAM low 32 bits, x = 1 .. 2
Category	optional
Access	R/W
PDO mapping	not possible
Value range	UNSIGNED32
Default value	0
Subindex	3 to 42
Description	DOUTx.PARAM high 32 bits, x = 1 .. 2
Category	optional
Access	R/W
PDO mapping	not possible
Value range	UNSIGNED32
Default value	0

19.33.3.50 Object 3496h: Fieldbus synchronization parameters

This set of objects is used to set or read parameters for the fieldbus synchronization used in the interpolated position mode (7) and the cyclic-modes 8 etc. The synchronization between a fieldbus master and the AKD PDMM is similar in all the supported fieldbus systems.

The AKD PDMM internal 16[kHz] interrupt function is responsible for calling the PLL function. This PLL function is called once per fieldbus cycle (set by object 60C2 sub 1 and 2). If the fieldbus sample period is for example 1[ms], the PLL code is called every 16th time of the 16[kHz] IRQ of the AKD PDMM.

Once in a fieldbus sample the SYNC-telegram must arrive, which resets a PLL counter in the Drive. After some time the already mentioned PLL function is called and reads back the time from that PLL counter.

Depending on the measured time the PLL function extends (in case that the measured time is too low) or lowers (in case that the measured time is too high) the sample time of the upcoming 16[kHz] tasks for one fieldbus sample by a selectable value (object 3496 sub 4) in order to move the PLL function closer to the expected distance (object 3496 sub 1).

Beside the objects mentioned here the parameter FBUS.SAMPLEPERIOD is important, which is set by object 60C2 sub 1 and 2. This setting is required in order to share the fieldbus sample time with the slave. This information is e.g. needed for being able to call the AKD PDMM internal PLL function once per fieldbus sample.

Index	3496h
Name	FBUS synchronization parameters
Object code	Array
Data type	UNSIGNED32
Category	optional
Subindex	0
Description	highest sub-index supported
Category	mandatory
Access	R/O
PDO mapping	not possible
Value range	0x4
Default value	0x4
Subindex	1
Description	FBUS.SYNCDIST
Category	optional
Access	R/W
PDO mapping	not possible
Value range	UNSIGNED32
Default value	320000 [ns]

Sub 1 is the expected time distance in nano seconds between clearing the PLL counter and calling the PLL function.

Subindex	2
Description	FBUS.SYNCACT
Category	optional
Access	R/W
PDO mapping	not possible
Value range	UNSIGNED32
Default value	320000 [ns]

Sub 2 is the actual time distance in nano seconds between clearing the PLL counter and calling the PLL function.

Subindex	3
Description	FBUS.SYNCWND
Category	optional
Access	R/W
PDO mapping	not possible
Value range	UNSIGNED32
Default value	70000 [ns]

Sub 3 is a window, which is used in order to consider the drive as being synchronized. The AKD PDMM is considered as synchronized in the following case:

$$FBUS.SYNCDIST - FBUS.SYNCWND < FBUS.SYNCACT < FBUS.SYNCDIST + FBUS.SYNCWND$$

Subindex	4
Description	FBUS.COMPTIME
Category	optional
Access	R/W
PDO mapping	not possible
Value range	UNSIGNED32
Default value	150 [ns]

Sub 4 value indicates the time, which is used for extending or lowering the sample rate of the AKD PDMM internal 16[kHz] IRQ, which is responsible for calling the PLL function. The default sample time is $32 * 1/16$ [kHz] = 2[ms].

The sample time of the AKD PDMM high prior interrupt is determined by $62.5[\mu\text{s}] - FBUS.COMPTIME$ if $FBUS.SYNCACT > FBUS.SYNCDIST$.

The sample time of the AKD PDMM high prior interrupt is determined by $62.5[\mu\text{s}] + FBUS.COMPTIME$ if $FBUS.SYNCACT < FBUS.SYNCDIST$.

19.33.3.51 Object 6040h: Control word (DS402)

The control commands are built up from the logical combination of the bits in the control word and external signals (e.g enable output stage). The definitions of the bits are shown below:

Index	6040h
Name	control word
Object code	VAR
Data type	UNSIGNED16
Access	R/W
PDO mapping	possible
Unit	—
Value range	0 to 65535
EEPROM	no
Default value	0

Bit assignment im control word

Bit	Name	Bit	Name
0	Switch on	8	Pause/halt
1	Disable Voltage	9	reserved
2	Quick Stop	10	reserved
3	Enable Operation	11	reserved
4	Operation mode specific	12	reserved
5	Operation mode specific	13	Manufacturer-specific
6	Operation mode specific	14	Manufacturer-specific
7	Reset Fault (only effective for faults)	15	Manufacturer-specific

Commands in the control word

Command	Bit 7 Fault Reset	Bit 3 Enable Operation	Bit 2 Quick Stop	Bit 1 Disable Voltage	Bit 0 Switch on	Transitions
Shutdown	X	X	1	1	0	2, 6, 8
Switch on	X	X	1	1	1	3
Disable Voltage	X	X	X	0	X	7, 9, 10, 12
Quick Stop	X	X	0	1	X	7, 10, 11
Disable Oper- ation	X	0	1	1	1	5
Enable Operation	X	1	1	1	1	4, 16
Fault Reset	1	X	X	X	X	15

Bits marked by an X are irrelevant.

Mode-dependent bits in the control word

The following table shows the mode-dependent bits in the control word. Only manufacturer-specific modes are supported at present. The individual modes are set by Object 6060_h Modes of operation.

Operation mode	No.	Bit 4	Bit 5	Bit 6
Profile Position Mode (pp)	01h	new_setpoint	change_set_immediately	absolute/relative
Profile Velocity Mode (pv)	03h	reserved	reserved	reserved
Profile Torque Mode (tq)	04h	reserved	reserved	reserved
Homing Mode (hm)	06h	homing_operation_start	reserved	reserved
Interpolated Position Mode (ip)	07h	Enable Interpolation	reserved	reserved
Cyclic sync position Mode (csp)	08h	reserved	reserved	reserved

Description of the remaining bits in the control word

The remaining bits in the control word are described below.

Bit 8 Pause If Bit 8 is set, then the drive halts (pauses) in all modes. The setpoints (speed for homing or jogging, motion task number, setpoints for digital mode) for the individual modes are retained.

Bit 9,10 These bits are reserved for the drive profile (DS402).

Bit 13, 14, 15 These bits are manufacturer-specific, and reserved at present.

19.33.3.52 Object 6041h: Status word (DS402)

The momentary state of the state machine can be read out with the aid of the status word.

Index	6041h
Name	Status word
Object code	VAR
Data type	UNSIGNED16
Access	R/W
PDO mapping	possible
Unit	—
Value range	0 to 65535
EEPROM	yes
Default value	0

Bit assignment in the status word

Bit	Name	Bit	Name
0	Ready to switch on	8	Manufacturer-specific (reserved)
1	Switched on	9	Remote
2	Operation enabled	10	Target reached
3	Fault	11	Internal limit active
4	Voltage enabled	12	Operation mode specific (reserved)
5	Quick stop	13	Operation mode specific (reserved)

6	Switch on disabled	14	Manufacturer-specific (reserved)
7	Warning	15	Manufacturer-specific (reserved)

States of the state machine

State	Bit 6 switch on disabled	Bit 5 quick stop	Bit 3 fault	Bit 2 operation enabled	Bit 1 switched on	Bit 0 ready to switch on
Not ready to switch on	0	X	0	0	0	0
Switch on disabled	1	X	0	0	0	0
Ready to switch on	0	1	0	0	0	1
Switched on	0	1	0	0	1	1
Operation enabled	0	1	0	1	1	1
Fault	0	X	1	0	0	0
Fault reaction active	0	X	1	1	1	1
Quick stop active	0	0	0	1	1	1

Bits marked by X are irrelevant

Description of the remaining bits in the status word

Bit 4: `voltage_enabled` The DC-link voltage is present if this bit is set.

Bit 7: `warning` There are several possible reasons for Bit 7 being set and this warning being produced. The reason of a warning can be seen by the Error code of the Emergency message, which is sent on the bus caused by this warning.

Bit 9: The remote-bit is set by the telnet command `FBUS.REMOTE`. The default state is 1 indicating that the power stage shall be only controlled by the DS402 control word. For special actions via telnet like tuning or commutation finding, `FBUS.REMOTE` shall be set to 0 via telnet to inform the fieldbus master.

Bit 10: `target_reached` This is set when the drive has reached the target position.

Bit 11: `internal_limit_active` This bit specifies that a movement was or is limited. In different modes, different warnings cause the bit to be set. The following assignments exist:

Mode of operation	Warnings which set Bit 11
all	n04, n06, n07, n10, n11, n14
0x1 (PP), 0x88	n03, n08, n09, n20

Mode-dependent bits in the status word

The following table shows the mode-dependent bits in the status word. The individual modes are set by " Object 6060h: Modes of Operation (DS402)" (→ p. 1027).

Operation mode	No.	Bit 12	Bit 13
Profile Position Mode (pp)	01h	setpoint acknowledge	following error
Homing Mode (hm)	06h	homing attained	homing error
Interpolated Position Mode (ip)	07h	ip mode active	following error
Cyclic sync position Mode (csp)	08h	This bit stays on 1 as long as the drive is following the position set-points.	following error

19.33.3.53 Object 6060h: Modes of Operation (DS402)

This object is used to set the mode, which can be read out by Object 6061h. Two types of operating mode are used:

- manufacturer-specific operating modes
- operating modes as per CANopen drive profile DS402

These operating modes are defined in the CANopen drive profile DS402. After the mode has been changed, the corresponding setpoint must be set once more (for instance, the homing velocity in the mode homing_setpoint). If the position or jogging mode is stored, then the Homing mode is set after a RESET of the drive.

NOTE

An operating mode only becomes valid when it can be read by Object 6061h.

**WARNING**

Never change the mode while the motor is running! The drive could move unexpectedly. When the drive is enabled, a mode change is only permissible at zero speed. Set the speed setpoint to 0 before changing over.

Index	6060h
Name	mode of operation
Object code	VAR
Data type	INTEGER8
Category	mandatory
Access	R/W
PDO mapping	possible
Value range	-3, -2, -1, 1, 3, 4, 6, 7, 8
Default value	—

Supported modes (negative values are manufacturer specific modes):

Value (hex)	Mode
-3	Analog current mode
-2	Analog velocity mode
-1	Electronic gearing mode
1	Profile position mode
3	Profile velocity mode
4	Profile torque mode
6	Homing mode
7	Interpolated position mode
8	Cyclic synchronous position mode

19.33.3.54 Object 6061h: Modes of Operation Display (DS402)

This object can be used to read the mode that is set by Object 6060h. An operating mode only becomes valid when it can be read by Object 6061h (see also Object 6060h).

Index	6061h
Name	mode of operation display
Object code	VAR
Data type	INTEGER8
Category	mandatory
Access	R/O
PDO mapping	possible
Value range	-3, -2, -1, 1, 3, 4, 6, 7, 8
Default value	—

19.33.3.55 Object 6063h: position actual value* (DS402)

The object position actual value provides the momentary actual position in increments. The resolution is defined with Object 608F as power-of-two number.

Index	6063h
Name	position actual value
Object code	VAR
Data type	INTEGER32
Mode	pc, pp
Access	R/W
PDO mapping	possible
Unit	increments (1 turn = 2^{PRBASE})
Value range	(-2^{31}) to $(2^{31}-1)$
Default value	2^{20}
EEPROM	no

19.33.3.56 Object 6064h: position actual value (DS402)

The object position actual value provides the actual position. The resolution can be altered by the gearing factors of the position controller (Object 6091/6092).

Index	6064h
Name	position actual value, PL.FB
Object code	VAR
Data type	INTEGER32
Mode	pp, csp
Access	R/W
PDO mapping	possible
Unit	position units

Value range	(-2^{31}) to $(2^{31}-1)$
Default value	—
EEPROM	no

19.33.3.57 Object 6065h: Following error window

The following error window defines a range of tolerated position values symmetrically to the position demand value. A following error might occur when a drive is blocked, unreachable profile velocity occurs, or at wrong closed loop coefficients. If the value of the following error window is 0, the following control is switched off.

Index	6065h
Name	Following error window
Object code	VAR
Data type	UNSIGNED32
Category	optional
Access	R/W
PDO mapping	not possible
Value range	UNSIGNED32
Default value	0

19.33.3.58 Object 606Ch: Velocity actual value (DS402)

The object velocity actual value represents the actual speed.

Index	606Ch
Name	velocity actual value, VL.FB
Object code	VAR
Data type	INTEGER32
Mode	pv
Access	R/O
PDO mapping	possible
Unit	velocity units (SDO is in user units and the PDO is in RPM)
Value range	(-2^{31}) to $(2^{31}-1)$
Default value	—
Float scaling	1000:1
EEPROM	no

19.33.3.59 Object 6071h: Target torque (DS402)

This parameter is the input value for the torque controller in profile torque mode and the value is given per thousand (1‰) of rated torque.

Index	6071h
Name	Target torque
Object code	VAR
Data type	INTEGER16
Category	conditional; mandatory, if tq supported
Access	R/W
PDO mapping	possible
Value range	INTEGER16
Default value	0

19.33.3.60 Object 6073h: Max current (DS402)

This value represents the maximum permissible torque creating current in the motor and is given per thousand (1‰) of rated current.

Index	6073h
Name	Max current
Object code	VAR
Data type	UNSIGNED16
Category	optional
Access	R/W
PDO mapping	not possible
Value range	UNSIGNED16
Default value	0

19.33.3.61 Object 6077h: Torque actual value (DS402)

The torque actual value corresponds to the instantaneous torque in the drive motor. The value is given per thousand (1‰) of rated torque.

Index	6077h
Name	Torque actual value
Object code	VAR
Data type	INTEGER16
Category	optional
Access	R/O
PDO mapping	possible
Value range	INTEGER16
Default value	0

19.33.3.62 Object 607Ah: Target position (DS402)

The object target position defines the target position for the drive. The target position is interpreted as a relative distance or an absolute position, depending on Bit 6 of the control word. The type of relative movement can be further defined by the manufacturer-specific parameter 35B9h Subindex 0. Other properties like following motion tasks can be set with this object as well. The mechanical resolution is set via the scaling objects 6091h and 6092h.

Index	607Ah
Name	target position, MT.P
Object code	VAR
Data type	INTEGER32
Mode	pp, csp
Access	R/W
PDO mapping	possible
Unit	user-defined
Value range	$-(2^{31}-1)$ to $(2^{31}-1)$
Default value	—

19.33.3.63 Object 607Ch: Homing offset (DS402)

The reference offset (home offset) is the difference between the zero position for the application and the zero point of the machine. All subsequent absolute motion tasks take account of the reference offset.

Index	607Ch
Name	home offset, HOME.P
Object code	VAR
Data type	INTEGER32
Mode	hm
Access	R/W
PDO mapping	not possible
Unit	user-defined
Value range	(-2^{31}) to $(2^{31}-1)$
Default value	0

19.33.3.64 Object 607Dh: Software position limit (DS402)

Software position limit contains the sub-parameters min position limit and max position limit. New target positions are checked against these limits. The limits are relative to the machine home position, which is the result of homing (including the home offset (Object 607Ch)). As default the software position limits are switched off. Changed values must be saved and the drive must be restarted to take enable the new the software limits.

Index	607Dh
Name	Software position limit, SWLS.LIMIT0
Object code	ARRAY
Data type	INTEGER32
Category	optional
Subindex	0
Description	highest sub-index supported
Category	mandatory
Access	R/O
PDO mapping	not possible
Value range	2
Default value	2
Subindex	1
Description	min position limit 1, SWLS.LIMIT0
Category	mandatory
Access	R/W
PDO mapping	not possible
Value range	INTEGER32
Default value	0 (switched off)
Subindex	2
Description	Min Position Limit 2, SWLS.LIMIT1
Category	mandatory
Access	R/W
PDO mapping	not possible
Value range	INTEGER32
Default value	0 (switched off)

19.33.3.65 Object 6081h: Profile velocity (DS402)

The profile velocity is the final velocity that should be reached after the acceleration phase of a motion task.

Index	6081h
Name	profile velocity, MT.V
Object code	VAR
Data type	UNSIGNED32
Mode	pp
Access	R/W
PDO mapping	possible
Unit	speed units
Value range	0 to $(2^{32}-1)$
Default value	10

19.33.3.66 Object 6083h: Profile acceleration (DS402)

The acceleration ramp (profile acceleration) is given in units that are defined by the user (position units per s²). The position units are scaled via the objects 6091 and 6092. This object is connected to the AKD PDMM-parameter DRV.ACC in the Profile Velocity Mode and to the motion task parameter MT.ACC in all other modes.

Index	6083h
Name	profile acceleration, MT.ACC (DRV.ACC in Profile Velocity Mode)
Object code	VAR
Data type	UNSIGNED32
Mode	pp, pv
Access	R/W
PDO mapping	possible
Unit	acceleration units
Value range	0 to $(2^{32}-1)$
Default value	0

19.33.3.67 Object 6084h: Profile deceleration (DS402)

The braking/deceleration ramp is handled in the same way as the acceleration ramp (" Object 6083h: Profile acceleration (DS402)" (→ p. 1033)).

Index	6084h
Name	profile deceleration, MT.DEC (DRV.DEC in Profile Velocity Mode)
Object code	VAR
Data type	UNSIGNED32
Mode	pp, pv
Access	R/W
PDO mapping	possible
Unit	deceleration units

Value range	0 to $(2^{32}-1)$
Default value	0

19.33.3.68 Object 608Fh: Position encoder resolution (DS402)

The position encoder resolution defines the ratio of encoder increments per motor revolution on the CANopen end. Encoder increments are set either directly by subindex 1 (only powers of 2 available) or implicit by writing to the parameter FB1.PSCALE.

Index	608Fh
Name	Position encoder resolution
Object Code	ARRAY
Data Type	UNSIGNED 32
Category	optional
Subindex	0
Name	highest sub-index supported
Data type	UNSIGNED8
Category	mandatory
Access	R/O
PDO Mapping	not possible
Value Range	2
Default Value	2
Subindex	1
Name	Encoder increments
Category	mandatory
Access	R/W
PDO Mapping	not possible
Value Range	UNSIGNED 32
Default Value	2 ²⁰
Subindex	2
Name	Motor revolutions
Category	mandatory
Access	R/W
PDO Mapping	not possible
Value Range	UNSIGNED 32
Default Value	1

19.33.3.69 Object 6091h: Gear Ratio (DS402)

The gear ratio defines the ratio of feed in position units per driving shaft revolutions. This includes the gear if present.

gear ratio = motor shaft revolutions / driving shaft revolutions

Index	6091h
Name	Gear Ratio
Object Code	ARRAY
Data Type	UNSIGNED 32
Category	optional
Subindex	0
Name	highest sub-index supported
Data type	UNSIGNED8
Category	mandatory
Access	R/O
PDO Mapping	not possible
Value Range	2
Default Value	2
Subindex	1
Name	Motor revolution
Category	mandatory
Access	R/W
PDO Mapping	not possible
Value Range	UNSIGNED 32
Default Value	1
Subindex	2
Name	Shaft revolutions
Category	mandatory
Access	R/W
PDO Mapping	not possible
Value Range	UNSIGNED 32
Default Value	1

19.33.3.70 Object 6092h: Feed constant (DS402)

The feed constant defines the ratio of feed in position units per driving shaft revolutions. This includes the gear if present.

Index	6092h
Name	Feed constant
Object Code	ARRAY
Data Type	UNSIGNED 32
Category	optional
Subindex	0
Name	highest sub-index supported
Data type	UNSIGNED8
Category	mandatory
Access	R/O
PDO Mapping	not possible
Value Range	2
Default Value	2
Subindex	1
Name	Feed
Category	mandatory
Access	R/W
PDO Mapping	not possible
Value Range	UNSIGNED 32
Default Value	1
Subindex	2
Name	Shaft revolutions
Category	mandatory
Access	R/W
PDO Mapping	not possible
Value Range	UNSIGNED 32
Default Value	1

19.33.3.71 Object 6098h: Homing method (DS402)

Index	6098h
Name	homing method, HOME.MODE, HOME.DIR
Object code	VAR
Data type	INTEGER8
Mode	hm
Access	R/W
PDO mapping	not possible
Unit	position units
Value range	-128 to 127
Default value	0

Description of the homing methods

Choosing a homing method by writing a value to homing method (Object 6098h) will clearly establish:

- the homing signal (P-Stop, N-Stop, reference switch)
- the direction of actuation

and where appropriate

- the position of the index pulse.

The reference position is give by the reference offset (Object 607Ch).

A detailed description of the types of homing movement can be found in the description of [EWV](#)¹.

The following homing methods are supported:

Method as per DS402	Brief description: Homing	command
-128 to -5	reserved	—
-4	find reference switch with fast velocity (6099h sub1) and home on reference switch with low velocity (6099h sub 2), positive count direction	HOME.MODE=16, HOME.DIR=0
-3	find reference switch with fast velocity (6099h sub 1) and home on reference switch with low velocity (6099h sub 2), negative count direction	HOME.MODE=16, HOME.DIR=0
-2 to -1	reserved	—
0	reserved	—
1	homing to negative limit switch, with zeroing, negative count direction	HOME.MODE=2, HOME.DIR=0
2	homing to positive limit switch, with zeroing, positive count direction	HOME.MODE=2, HOME.DIR=1
3 to 7	not supported	—
8	homing to reference switch, with zeroing, positive count direction	HOME.MODE=5, HOME.DIR=1
9 to 11	not supported	—

¹Embedded Workbench Views

Method as per DS402	Brief description: Homing	command
12	homing to reference switch, with zeroing, negative count direction	HOME.MODE=5, HOME.DIR=0
13 to 14	not supported	—
15 to 16	reserved	—
17	homing to negative limit switch, without zeroing, negative count direction	HOME.MODE=1, HOME.DIR=0
18	homing to negative limit switch, without zeroing, positive count direction	HOME.MODE=1, HOME.DIR=1
19 to 23	not supported	—
24	homing to reference switch, without zeroing, positive count direction	HOME.MODE=4, HOME.DIR=1
25 to 27	not supported	—
28	homing to reference switch, without zeroing, negative count direction	HOME.MODE=4, HOME.DIR=0
29 to 30	not supported	—
31 to 32	reserved	—
33	homing within a single turn, negative count direction. If the feedback has an index pulse, HOME.MODE 11 will be used.	HOME.MODE=7,11 HOME.DIR=0
34	homing within a single turn, positive count direction. If the feedback has an index pulse, HOME.MODE 11 will be used.	HOME.MODE=7,11 HOME.DIR=1
35	set reference point at present position	HOME.MODE=0, HOME.DIR=0
36 to 127	reserved	—

19.33.3.72 Object 6099h: Homing speeds (DS402)

Index	6099h
Name	homing speeds
Object code	ARRAY
Data type	UNSIGNED32
Subindex	1
Description	speed during search for switch, HOME.V
Mode	hm
Access	R/W
PDO mapping	not possible
Unit	velocity units
Value range	0 to $(2^{32}-1)$
Default value	equivalent 60 rpm
Subindex	2

Description	speed during search for zero, HOME.FEEDRATE
Mode	hm
Access	R/W
PDO mapping	not possible
Unit	velocity units
Value range	0 to $(2^{32}-1)$
Default value	1/8 * Object 6099 sub 1

19.33.3.73 Object 609Ah: Homing acceleration (DS402)

Index	609Ah
Name	homing acceleration
Object code	VAR
Data type	UNSIGNED32
Mode	hm
Access	R/W
PDO mapping	not possible
Unit	acceleration units
Value range	0 to $(2^{32}-1)$
Default value	0

19.33.3.74 Object 60B1h: Velocity Offset

This object provides the offset of the velocity value in cyclic synchronous position mode. It is scaled via the object 204Ch.

Index	60B1h
Name	Velocity Offset
Object code	VAR
Data type	INTEGER32
Category	optional
Access	R/W
PDO mapping	possible
Value range	INTEGER32
Default value	0

19.33.3.75 Object 60B2h: Torque Offset

This object provides the offset of the commanded torque value in cyclic synchronous position mode. Scaling is 1/1000 of rated torque.

Index	60B2h
Name	Torque Offset
Object code	VAR
Data type	INTEGER16
Category	optional
Access	R/O
PDO mapping	possible
Value range	INTEGER16
Default value	0

19.33.3.76 Object 60B8h: Touch probe function

This object indicates the configured function of the touch probe.

Index	60B8h
Name	Touch probe function
Object code	Variable
Data type	UNSIGNED16
Category	optional
Access	R/W
PDO Mapping	yes
Value range	UNSIGNED16
Default value	0

Definition of the possible functions:

Bit	Value	Meaning
0	0	Switch off touch probe 1
	1	Enable touch probe 1
1	0	Trigger first event
	1	Continuous
3, 2	00b*	Trigger with touch probe 1 input
	01b	Trigger with zero impulse signal or position encoder
	10b	Touch probe source as defined in object 60D0h, sub-index 01h
	11b	reserved
4	0	Switch off sampling at positive edge of touch probe 1
	1	Enable sampling at positive edge of touch probe 1
5	0	Switch off sampling at negative edge of touch probe 1
	1	Enable sampling at negative edge of touch probe 1
6, 7	-	User-defined (e.g. for testing)
8	0	Switch off touch probe 2
	1	Enable touch probe 2
9	0	Trigger first event
	1	continuous
11, 10	00b	Trigger with touch probe 2 input
	01b	Trigger with zero impulse signal or position encoder
	10b	Touch probe source as defined in object 60D0h, sub-index 02h
	11b	reserved
12	0	Switch off sampling at positive edge of touch probe 2
	1	Enable sampling at positive edge of touch probe 2
13	0	Switch off sampling at negative edge of touch probe 2
	1	Enable sampling at negative edge of touch probe 2
14, 15	-	User-defined (e.g. for testing)

* b = binary

If both edges are selected at the same time (bit 4=1 and bit 5=1 for probe 1 or bit 12=1 and bit 13=1 for probe 2), the first edge (positive or negative) triggers the probe function. The position, latched at this edge, is taken over for both edges (positive and negative).

19.33.3.77 Object 60B9h: Touch probe status

This object indicates the status of the touch probe.

Index	60B9h
Name	Touch probe status
Object code	Variable
Data type	UNSIGNED16
Category	optional
Access	R/O
PDO Mapping	yes
Value range	UNSIGNED16
Default value	0

Definition of the status:

Bit	Value	Meaning
0	0	Touch probe 1 is switched off
	1	Touch probe 1 is enabled
1	0	Touch probe 1 no positive edge value stored
	1	Touch probe 1 positive edge position stored
2	0	Touch probe 1 no negative edge value stored
	1	Touch probe 1 negative edge position stored
3 to 5	0	reserved
6, 7	-	User-defined (e.g. for testing)
8	0	Touch probe 2 is switched off
	1	Touch probe 2 is enabled
9	0	Touch probe 2 no positive edge value stored
	1	Touch probe 2 positive edge position stored
10	0	Touch probe 2 no negative edge value stored
	1	Touch probe2 negative edge position stored
11 to 13	0	reserved
14, 15	-	User-defined (e.g. for testing)

19.33.3.78 Object 60BAh: Touch probe 1 positive edge

This object provides the position value of the touch probe 1 at positive edge.

Index	60BAh
Name	Touch probe 1 positive edge
Object code	Variable
Data type	INTEGER32
Category	optional
Access	R/O
PDO Mapping	yes
Value range	INTEGER32
Default value	no

19.33.3.79 Object 60BBh: Touch probe 1 negative edge

This object provides the position value of the touch probe 1 at negative edge.

Index	60BBh
Name	Touch probe 1 negative edge
Object code	Variable
Data type	INTEGER32
Category	optional
Access	R/O
PDO Mapping	yes
Value range	INTEGER32
Default value	no

19.33.3.80 Object 60BCh: Touch probe 2 positive edge

This object provides the position value of the touch probe 2 at positive edge.

Index	60BCh
Name	Touch probe 2 positive edge
Object code	Variable
Data type	INTEGER32
Category	optional
Access	R/O
PDO Mapping	yes
Value range	INTEGER32
Default value	no

19.33.3.81 Object 60BDh: Touch probe 2 negative edge

This object provides the position value of the touch probe 2 at negative edge.

Index	60BDh
Name	Touch probe 2 negative edge
Object code	Variable
Data type	INTEGER32
Category	optional
Access	R/O
PDO Mapping	yes
Value range	INTEGER32
Default value	no

19.33.3.82 Object 60C0h: Interpolation sub mode select

In the AKD PDMM, linear interpolation between position setpoints is supported.

Index	60C0h
Name	Interpolation sub mode select
Object code	VAR
Data type	INTEGER16
Category	optional
Access	R/W
PDO mapping	not possible
Value range	0
Default value	0

Value description

Value(decimal)	Description
0	Linear interpolation with a constant time.

19.33.3.83 Object 60C1h: Interpolation data record

In the AKD PDMM, a single setpoint (target position, Subindex 1) is supported for the linear interpolation. After the last item of an interpolation data record is written to the devices input buffer, the buffer pointer is automatically incremented to the next buffer.

Index	60C1h
Name	Interpolation data record
Object code	ARRAY
Data type	INTEGER32
Category	optional
Subindex	0
Description	highest sub-index supported
Data type	UNSIGNED8
Category	mandatory
Access	R/O
PDO mapping	not possible
Value range	1
Default value	1
Subindex	1
Description	Interpolation target position in counts, the first parameter of interpolation function
Category	mandatory
Access	R/W
PDO mapping	possible
Value range	INTEGER32
Default value	no

NOTE

A set-point value of the Interpolation data record is only taken, if beside the state machine state "Operation Enable" also the bit 4 of the DS402 controlword (Enable Interpolation, see "Object 6040h: Control word (DS402)" (→ p. 1023)) is set.

19.33.3.84 Object 60C2h: Interpolation time period

The interpolation time period is used for the PLL (phase locked loop) synchronized position modes. The unit (subindex 1) of the time is given in $10^{\text{interpolation time index}}$ seconds.

Only multiples of 1 ms are allowed. The two values define the internal AKD PDMM parameter FBUS.SAMPLEPERIOD (given in multiples of 62.5 Mikroseconds). Both values must be written to set a new interpolation time period. FBUS.SAMPLEPERIOD will only be updated then.

Index	60C2h
Name	Interpolation time period
Object code	RECORD
Data type	Interpolation time period record (0080h)
Category	optional
Subindex	0
Description	highest sub-index supported, FBUS.SAMPLEPERIOD
Category	mandatory
Access	R/O
PDO mapping	not possible
Value range	2
Default value	2
Subindex	1
Description	Interpolation time units
Category	mandatory
Access	R/W
PDO mapping	not possible
Value range	UNSIGNED8
Default value	2
Subindex	2
Description	Interpolation time index
Category	mandatory
Access	R/W
PDO mapping	not possible
Value range	INTEGER8
Default value	-3

19.33.3.85 Object 60C4h: Interpolation data configuration

In the AKD PDMM, for linear interpolation, only the value 1 in Subindex 5 is possible. For cubic interpolation, Subindex 1 and Subindex 2 is possible for manage the buffer of cubic interpolation.

Index	60C4h
Name	Interpolation data configuration
Object code	RECORD
Data type	Interpolation data configuration record (0081h)
Category	optional
Subindex	0
Description	highest sub-index supported
Category	mandatory
Access	R/O
PDO mapping	not possible
Value range	6
Default value	6
Subindex	1
Description	Maximum buffer size
Category	mandatory
Access	R/O
PDO mapping	not possible
Value range	UNSIGNED32
Default value	10
Subindex	2
Description	Actual buffer size
Category	mandatory
Access	R/O
PDO mapping	possible
Value range	0 to 9
Default value	9
Subindex	3
Description	Buffer organization
Category	mandatory
Access	R/W
PDO mapping	not possible
Value range	UNSIGND8
Default value	0

Subindex	4
Description	Buffer position
Category	mandatory
Access	R/W
PDO mapping	not possible
Value range	UNSIGNED16
Default value	0
Subindex	5
Description	Size of data record
Category	mandatory
Access	W
PDO mapping	not possible
Value range	1 to 254
Default value	1
Subindex	6
Description	Buffer clear
Category	mandatory
Access	W
PDO mapping	not possible
Value range	UNSIGNED8
Default value	0

19.33.3.86 Object 60D0h: Touch probe source

This object provides the source of the touch probe function, when the dedicated bits 2/3 or 10/11 of the touch probe function (object 60B8h) are set accordingly.

Index	60D0h
Name	Touch probe source
Object code	Array
Data type	Integer 16
Category	optional
Subindex	0
Description	Highest sub-index supported
Category	mandatory
Access	R/O
PDO mapping	not possible
Value range	2
Default value	2
Subindex	1
Description	Touch probe 1 source
Category	mandatory
Access	R/W
PDO mapping	not possible
Value range	-11 to -1, 1 to 5
Default value	1
Subindex	2
Description	Touch probe 2 source
Category	mandatory
Access	R/W
PDO mapping	not possible
Value range	-11 to -1, 1 to 5
Default value	1

Value description:

Value	Description	Value	Description
1	Touch Probe 1 Input	3	Touch Probe 3 Input
2	Touch Probe 2 Input	4	Touch Probe 4 Input
-1 to -11	AKD PDMM Input related to CAPx.TRIGGER 0 to 10		

19.33.3.87 Object 60E0h: Positive Torque Limit Value

The object gives the configured maximum motor torque in positive direction. The value is given per thousand (1 ‰) of rated torque.

Index	60E0h
Name	Positive Torque Limit Value
Object code	Variable
Data type	UIINTEGER16
Category	optional
Access	R/O
PDO Mapping	yes
Value range	UIINTEGER16 (limited by DRV.IPEAK and MOTOR.IPEAK)
Default value	0

19.33.3.88 Object 60E1h: Negative Torque Limit Value

The object gives the configured maximum motor torque in negative direction. The value is given per thousand (1 ‰) of rated torque.

Index	60E1h
Name	Negative Torque Limit Value
Object code	Variable
Data type	UIINTEGER16
Category	optional
Access	R/O
PDO Mapping	yes
Value range	UIINTEGER16 (limited by DRV.IPEAK and MOTOR.IPEAK)
Default value	0

19.33.3.89 Object 60E4h: Additional position actual value

This object provides the additional position actual values. The values are given in user-defined position units. The value is calculated analog to the calculation for the actual position 6064h via object 6091h and 6092h, but for this with the factors given by the objects 60E8h, 60E9h, 60EDh and 60EEh.

Index	60E4h
Name	Additional position actual value
Object code	ARRAY
Data type	INTEGER32
Category	optional
Subindex	0
Description	highest sub-index supported
Category	mandatory
Access	R/O
PDO mapping	not possible
Value range	3
Default value	3
Subindex	1
Description	1st additional position actual value
Category	mandatory
Access	R/W
PDO mapping	not possible
Value range	INTEGER32
Default value	1
Subindex	2
Description	reserved
Category	
Access	
PDO mapping	
Value range	
Default value	
Subindex	3
Description	3rd additional position actual value
Category	optional
Access	R/W
PDO mapping	not possible
Value range	INTEGER32
Default value	0

19.33.3.90 Object 60E8h: Additional gear ratio – motor shaft revolutions

This object provides the motor shaft revolutions for the additional gear ratio calculation. This object shall be used with the corresponding subindex of the object 60EDh (driving shaft revolutions for the additional gear ratio calculation). The value of the object 60E4h is calculated analog to the gear ration calculation for the actual position 6064h via object 6091h.

Index	60E8h
Name	Additional gear ratio – motor shaft revolutions
Object code	ARRAY
Data type	UNSIGNED32
Category	optional
Subindex	0
Description	highest sub-index supported
Category	mandatory
Access	R/O
PDO mapping	not possible
Value range	3
Default value	3
Subindex	1
Description	1st additional gear ratio - motor shaft
Category	mandatory
Access	R/W
PDO mapping	not possible
Value range	UNSIGNED32
Default value	1
Subindex	2
Description	reserved
Category	
Access	
PDO mapping	
Value range	
Default value	
Subindex	3
Description	3rd additional gear ratio - motor shaft
Category	optional
Access	R/W
PDO mapping	not possible
Value range	UNSIGNED32
Default value	1

19.33.3.91 Object 60E9h: Additional feed constant – feed

This object provides the feed for the additional feed constant calculation. This object shall be used with the corresponding subindex of the object 60EEh (driving shaft revolutions for the additional feed constant calculation). The value of the object 60E4h is calculated analog to the feed constant calculation for the actual position 6064h via object 6092h.

Index	60E9h
Name	Additional feed constant – feed
Object code	ARRAY
Data type	UNSIGNED32
Category	optional
Subindex	0
Description	highest sub-index supported
Category	mandatory
Access	R/O
PDO mapping	not possible
Value range	3
Default value	3
Subindex	1
Description	1st additional feed constant – feed
Category	mandatory
Access	R/W
PDO mapping	not possible
Value range	UNSIGNED32
Default value	1
Subindex	2
Description	reserved
Category	
Access	
PDO mapping	
Value range	
Default value	
Subindex	3
Description	3rd additional feed constant – feed
Category	optional
Access	R/W
PDO mapping	not possible
Value range	UNSIGNED32
Default value	1

19.33.3.92 Object 60EDh: Additional gear ratio – driving shaft revolutions

This object provides the driving shaft revolutions for the additional gear ratio calculation. This object shall be used with the corresponding subindex of the object 60E8h (motor shaft revolutions for the additional gear ratio calculation). The value of the object 60E4h is calculated analog to the gear ration calculation for the actual position 6064h via object 6091h.

Index	60EDh
Name	Additional gear ratio – driving shaft revolutions
Object code	ARRAY
Data type	UNSIGNED32
Category	optional
Subindex	0
Description	highest sub-index supported
Category	mandatory
Access	R/O
PDO mapping	not possible
Value range	3
Default value	3
Subindex	1
Description	1st additional gear ratio - driving shaft
Category	mandatory
Access	R/W
PDO mapping	not possible
Value range	UNSIGNED32
Default value	1
Subindex	2
Description	reserved
Category	
Access	
PDO mapping	
Value range	
Default value	
Subindex	3
Description	3rd additional gear ratio - driving shaft
Category	optional
Access	R/W
PDO mapping	not possible
Value range	UNSIGNED32
Default value	1

19.33.3.93 Object 60EEh: Additional feed constant - driving shaft revolutions

This object provides the driving shaft revolutions for the additional feed constant calculation. This object shall be used with the corresponding subindex of the object 60E9h (feed for the additional feed constant calculation). The value of the object 60E4h is calculated analog to the feed constant calculation for the actual position 6064h via object 6092h.

Index	60EEh
Name	Additional feed constant - driving shaft revolutions
Object code	ARRAY
Data type	UNSIGNED32
Category	optional
Subindex	0
Description	highest sub-index supported
Category	mandatory
Access	R/O
PDO mapping	not possible
Value range	3
Default value	3
Subindex	1
Description	1st additional feed constant – driving shaft revolutions
Category	mandatory
Access	R/W
PDO mapping	not possible
Value range	UNSIGNED32
Default value	1
Subindex	2
Description	reserved
Category	
Access	
PDO mapping	
Value range	
Default value	
Subindex	3
Description	3rd additional feed constant – driving shaft revolutions
Category	optional
Access	R/W
PDO mapping	not possible
Value range	UNSIGNED32
Default value	1

19.33.3.94 Object 60F4h: Following error actual value (DS402)

This object returns the current value of the following error in units defined by the user.

Index	60F4h
Name	Following error actual value
Object code	VAR
Data type	Integer32
Category	optional
Access	R/O
PDO mapping	possible
Value range	INTEGER32
Default value	0

19.33.3.95 Object 60FCh: Position demand internal value (DS402)

This object provides the output of the trajectory generator in position modes. The value is consistent in scaling to the actual internal position value (6063h) and the first setpoint in object 60C1h.

Index	60FCh
Name	Position demand internal value
Object code	VAR
Data type	INTEGER32
Category	optional
Access	R/O
PDO mapping	possible
Value range	INTEGER32
Default value	0

19.33.3.96 Object 60FDh: Digital inputs (DS402)

This index defines simple digital inputs for drives. The manufacturer bits 16 to 2216 to 18 display the actual state of the digital inputs 1 to 71 to 3 (DINx.STATE). The manufacturer bits 24 to 3024 to 26 latch a state change of the digital inputs 1 to 71 to 3. Bits 24 to 3024 to 26 can be reset with object"20B8h" (→ p. 1015).

Index	60FDh
Name	digital inputs
Object code	VAR
Data type	UNSIGNED32
Category	optional
Access	R/O
PDO mapping	possible
Value range	UNSIGNED32
Default value	0

31	16	15	4	3	2	1	0
manufacturer specific		reserved		enable	home switch	pos. limit switch	neg. limit switch
MSB							LSB

19.33.3.97 Object 60FEh: Digital outputs (DS402)

This index defines simple digital outputs for drives. The manufacturer bits 16 and 17 are bit 16 is show the actual status of the digital outputs 1 and 2 output 1.

Index	60FEh					
Name	digital outputs					
Object code	Array					
Data type	UNSIGNED32					
Category	optional					
Subindex	0					
Description	highest sub-index supported					
Category	mandatory					
Access	R/O					
PDO mapping	not possible					
Value range	2					
Default value	2					
Subindex	1					
Description	physical outputs					
Category	mandatory					
Access	R/W					
PDO mapping	possible					
Value range	UNSIGNED32					
Default value	0					
Subindex	2					
Description	bit mask					
Category	optional					
Access	R/W					
PDO mapping	not possible					
Value range	UNSIGNED32					
Default value	0					
31	18	17	16	15	1	0
manufacturer specific	DOUT2	DOUT1	reserved		set brake	
MSB					LSB	

19.33.3.98 Object 60FFh: Target velocity (DS402)

The speed setpoint (target velocity) represents the setpoint for the ramp generator.

Index	60FFh
Name	target velocity, VL.CMDU
Object code	VAR
Data type	INTEGER32
Mode	pv
Access	R/W
PDO mapping	possible
Unit	increments
Value range	(-2^{31}) to $(2^{31}-1)$
Default value	—
Float scaling	1000:1
EEPROM	no

19.33.3.99 Object 6502h: Supported drive modes (DS402)

A drive can support more than one and several distinct modes of operation. This object gives an overview of the implemented operating modes in the device. This object is read only.

Index	6502h
Name	supported drive modes
Object code	VAR
Data type	UNSIGNED32
Category	optional
Access	R/O
PDO mapping	not possible
Value range	UNSIGNED32
Default value	0xE5 (csp ip hm pv pp)

31	16	15	11	10	9	8	7	6	5	4	3	2	1	0
manufacturer specific	reserved	cstca	cst	csv	csp	ip	hm	reserved	tq	pv	vl	pp		
MSB														LSB

This page intentionally left blank.

20 EtherCAT Profile

20.1 Slave Register	910
20.2 AL Event (Interrupt Event) and Interrupt Enable	911
20.3 Phase Run-Up	913
20.4 CANopen over EtherCAT (CoE) State Machine	916
20.5 Fixed PDO Mappings	921
20.6 Flexible PDO Mappings	923
20.7 Supported Cyclical Setpoint and Actual Values	929
20.8 Supported Operation Modes	931
20.9 Adjusting EtherCAT Cycle Time	931
20.10 Maximum Cycle Times depending on operation mode	931
20.11 Synchronization	933
20.12 Latch Control Word and Latch Status Word	934
20.13 Mailbox Handling	936
20.14 Fieldbus Parameters	942
20.15 EEPROM Content	943

20.1 Slave Register

The table below gives the addresses of individual registers in the FPGA memory. The data is provided in little-endian format, with the 'least significant byte' occupying the lowest address. A detailed description of all registers and FPGA memory locations is available in the "EtherCAT Slave Controller" description of the EtherCAT user organization (www.EtherCAT.org).

Address	Length (Byte)	Description	ZA ECAT*	ZA Drive*
0x0120	2	AL Control	R/W	R/O
0x0130	2	AL Status	R/O	R/W
0x0134	2	AL Status Code	R/O	R/W
0x0204	2	Interrupt Enable Register	R/O	R/W
0x0220	2	AL Event (IRQ Event)	R/W	R/O
0x0800	8	Sync Manager 0 (Mail Out Control Register)	R/W	R/O
0x0808	8	Sync Manager 1 (Mail In Control Register)	R/W	R/O
0x0810	8	Sync Manager 2 (Process data Output Control Register)	R/W	R/O
0x0818	8	Sync Manager 3 (Process data Input Control Register)	R/W	R/O
0x0820	8	Sync Manager 4	R/W	R/O
0x0828	8	Sync Manager 5	R/W	R/O
0x0830	8	Sync Manager 6	R/W	R/O
0x0838	8	Sync Manager 7	R/W	R/O
0x0840	8	Sync Manager 8	R/W	R/O
0x1100	Max. 64	ProOut Buffer (Process data Output, set-points ECAT)	R/W	R/O
0x1140	Max. 64	ProIn (Process data Input, act. values ECAT)	R/O	R/W
0x1800	512	Mail Out Buffer (Object Channel Buffer ECAT, byte-length is specified in the device description file)	R/W	R/O
0x1C00	512	Mail In Buffer (Object Channel Buffer Drive, byte-length is specified in the device description file)	R/O	R/W

* ZA ECAT = Access mode EtherCAT

* ZA Drive = Access mode drive

20.2 AL Event (Interrupt Event) and Interrupt Enable

Communication between the drive and the EtherCAT FPGA can be interrupt-driven. The interrupt enable register and the AL event register are responsible for the EtherCAT interface interrupt functionality.

There are two events which lead also to a HW interrupt within the drive, the EEPROM emulation event and the SyncManager 2 event. The actual values of the drive (SyncManager 3 data) are written without any AL event request during each HW IRQ, e.g. triggered by a SyncManager 2 event. The Mailbox exchange between the master and the AKD PDMM is completely handled by polling the AL event register within the background task of the drive.

The drive activates individual EtherCAT interface events when the corresponding bit of the interrupt enable register is set to 1. When it is set to 0, the hardware interrupts for the specific events are deactivated.

20.2.1 Interrupt Enable Register (Address 0x0204:0x0205)

Parameter	Address	Bit	ZA Drive	ZA ECAT	Description
AL Control Event	0x204	0	R/W	R/O	Activation of AL control event for phase run-up
-	0x204	1	R/W	R/O	Reserved
Sync0 DC Distributed Clock	0x204	2	R/W	R/O	Activation of distributed clock (DC) sync 0 interrupts for entire communication
Sync1 DC Distributed Clock	0x204	3	R/W	R/O	Activation of distributed clock (DC) sync 1 interrupts for entire communication
SyncManager activation register change	0x204	4	R/W	R/O	Activation of 'SyncManager activation register change' IRQ.
EEPROM emulation event	0x204	5	R/W	R/O	Activation of the EEPROM emulation interrupts.
-	0x204	3 to 7	R/W	R/O	Reserved
Sync Manager 0 Event (Mail Out Event)	0x205	0	R/W	R/O	Activation of output event mailbox (SDO, Sync Manager 0) for object channel.
Sync Manager 1 Event (Mail In Event)	0x205	1	R/W	R/O	Activation of input event mailbox (SDO, Sync Manager 1) for object channel.
Sync Manager 2 Event (Pro Out Event)	0x205	2	R/W	R/O	Activation of output event process data (PDO, card's cyclical setpoints)
Sync Manager 3 Event (Pro In Event)	0x205	3	R/W	R/O	Activation of input event process data (PDO, drive's cyclical actual values)
-	0x205	4 to 7	R/W	R/O	Reserved

20.2.2 AL Event Request (Address 0x0220:0x0221)

When the relevant bit of the AL event request register is set to 1, the EtherCAT interface tells the drive which event it should process by the AKD PDMM.

Parameter	Address	Bit	ZA Drive	ZA ECAT	Description
AL Control Event	0x220	0	R/O	R/W	Processing of AL control event for phase run-up
Sync0 Distributed Clock (DC) Event	0x220	2	R/O	R/W	Processing of a distributed clock (DC) event
Sync1 Distributed Clock (DC) Event	0x220	3	R/O	R/W	Processing of a distributed clock (DC) event
SyncManager activation register change	0x220	4	R/O	R/W	The content of the SyncManager activation register has been changed.
EEPROM emulation event	0x220	5	R/O	R/W	Processing of an EEPROM emulation event in order to identify the AKD PDMM within the network.
-	0x220	6 to 7	R/O	R/W	Reserved
Sync Manager 0 Event	0x221	0	R/O	R/W	Mailbox request (SDO, Sync Manager 0) for object channel.
Sync Manager 1 Event	0x221	1	R/O	R/W	Mailbox response (SDO, Sync Manager 1) for object channel.
Sync Manager 2 Event	0x201	2	R/O	R/W	Process data output (PDO, card's cyclical setpoints)
Sync Manager 3 Event	0x201	3	R/O	R/W	Process data input (PDO, drive's cyclical actual values)
Sync Manager 4 –					
Sync Manager 7 Event	0x221	4 to 7	R/O	R/W	Reserved
Sync Manager 8 –					
Sync Manager 15 Event	0x222	0 to 7	R/O	R/W	Reserved

20.3 Phase Run-Up

The AL control, AL status and AL status code registers are responsible for communication phase run-up (also referred to as EtherCAT status change), for current status display and for any fault messages. The drive responds to every EtherCAT interface transition request made by the AL control register via the AL Status and AL Status Code registers. Any fault messages are displayed in the AL status code register.

A status change within the AL control register is polled within the AKD PDMM, which means that an AL control event does not lead to a HW interrupt within the drive.

20.3.1 AL Control (Address 0x0120:0x0121)

Parameter	Address	Bit	ZA Drive	ZA ECAT	Description
Status	0x120	3 to 0	R/O	W/O	0x01: Init Request
0x02: PreOperational Request					
0x03: Bootstrap Mode Request					
0x04: Safe Operational Request					
0x08: Operational Request					
Acknowledgement	0x120	4	R/O	W/O	0x00: No fault acknowledgement 0x01: Fault acknowledgement (positive edge)
Reserved	0x120	7 to 5	R/O	W/O	-
Applic. specific	0x120	15 to 8	R/O	W/O	-

20.3.2 AL Status (Address 0x0130:0x0131)

Parameter	Address	Bit	ZA Drive	ZA ECAT	Description
Status	0x130	3 to 0	W/O	R/O	0x01: Init
0x02: PreOperational					
0x03: Bootstrap Mode					
0x04: Safe Operational					
0x08: Operational					
Status change	0x130	4	W/O	R/O	0x00: Acknowledgement 0x01: Error, e.g. forbidden transition
Reserved	0x130	7 to 5	W/O	R/O	-
Applic. specific	0x130	15 to 8	W/O	R/O	-

20.3.3 AL Status Code (Address 0x0134:0x0135)

Parameter	Address	Bit	ZA Drive	ZA ECAT	Description
Status	0x134	7 to 0	W/O	R/O	See table below
Status	0x135	7 to 0	W/O	R/O	See table below
Code	Description		Current Status (Status change)		Resulting Status
0x0000	No error		All		Current Status
0x0011	Invalid requested state change		I -> S, I -> O, P -> O, O -> B, S -> B, P -> B		Current Status + E
0x0017	Invalid sync manager configuration		I -> P, P -> S		Current Status + E

No other codes are supported.

20.3.4 EtherCAT communication phases

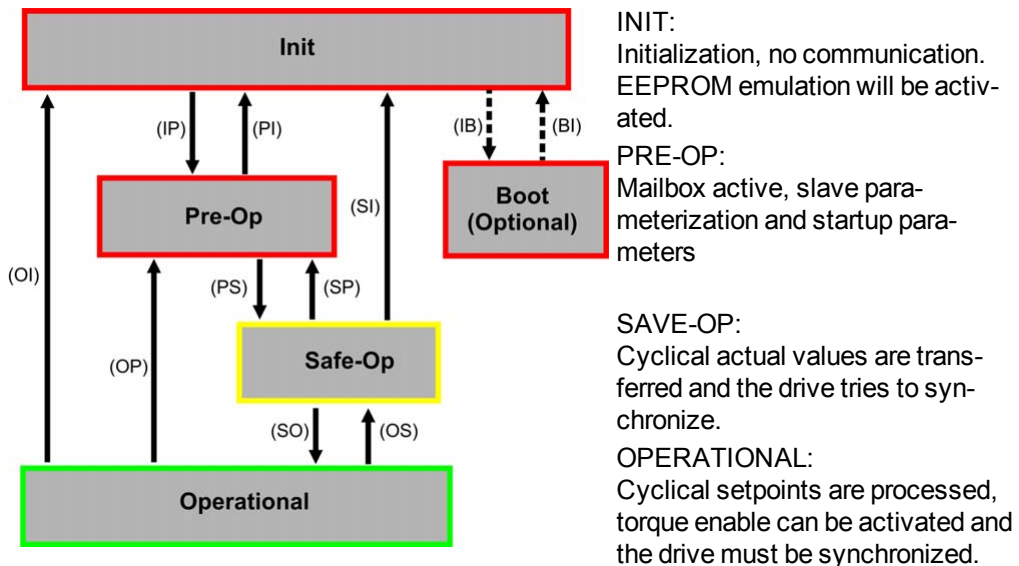

Individual communication transitions

Transition	AL Control (Bit 3 to 0)	Description
(IB)	0x03	-
(BI)	-	-
(IP)	0x02	AKD PDMM reads the SyncManager 0 & 1 configuration and verifies the value of the start-address and the length. The AKD PDMM prepares itself for handling SyncManager 0 events.
(PI)	0x01	-
(PS)	0x04	AKD PDMM reads the SyncManager 2 & 3 configuration and verifies the value of the start-address and the length.
(SP)	0x02	-
(SI)	0x01	-

Transition	AL Control (Bit 3 to 0)	Description
(SO)	0x08	The SsyncManager 2 hardware interrupt will be enabled by the drive.
(OS)	0x04	Deactivation of SsyncManager 2 hardware interrupt.
(OP)	0x02	Deactivation of SsyncManager 2 hardware interrupt..
(OI)	0x01	Deactivation of SsyncManager 2 hardware interrupt.

20.4 CANopen over EtherCAT (CoE) State Machine

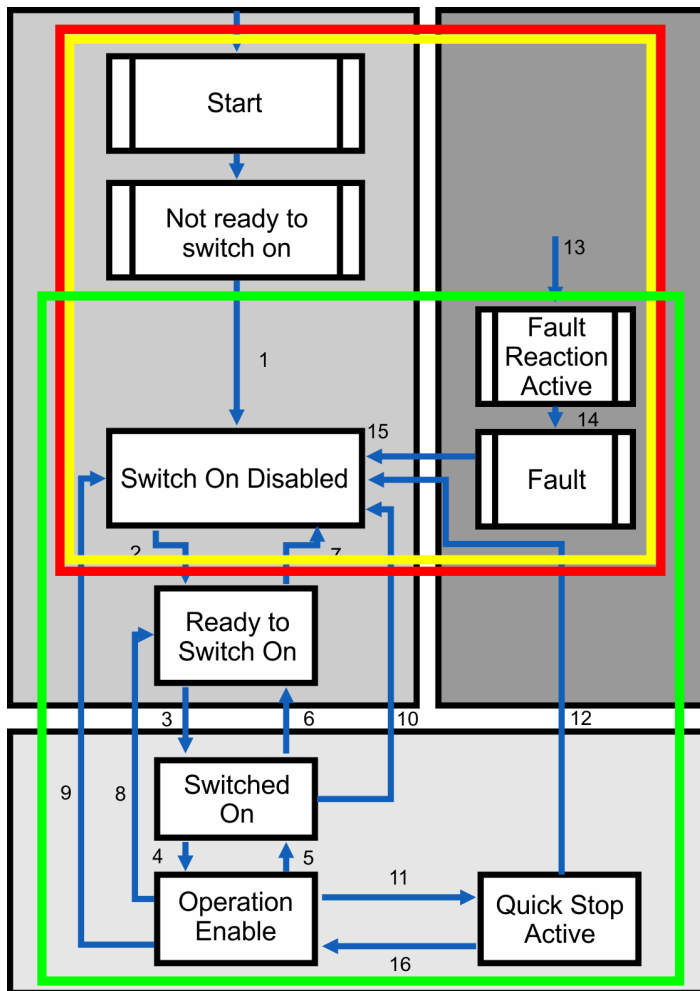

The state machine for the control and status words corresponds to the CANopen state machine in accordance with DS402.

CANopen control and status words are captured in every instance of fixed PDO mapping (see chapter "Fixed PDO Mappings" (→ p. 921)).

20.4.1 Status Description

Status	Description
Not Ready to Switch On	The drive is not ready to switch on; the controller has not indicated readiness for service. The drive is still in the boot phase or in fault status.
Switch On Disable	In 'Switch On Disable' status, the amplifier cannot be enabled via the EtherCAT interface, because (for example) there is no connection to a power source.
Ready to Switch On	In 'Ready to Switch On' status, the drive can be enabled via the control word.
Switched On	In 'Switched On' status, the amplifier is enabled, but the setpoints of the EtherCAT-interface are not yet transferred. The amplifier is idle, and a positive edge in bit 3 of the control word activates setpoint transfer (transition to 'Operation Enable' status).
Operation Enable	In this status, the drive is enabled and setpoints are transferred from the EtherCAT interface.
Quick Stop Active	The drive follows a quick stop ramp.
Fault Reaction Active	The drive responds to a fault with an emergency stop ramp.

Status	Description
Fault	A fault is pending, the drive is stopped and disabled.

20.4.2 Commands in the Control Word

Bit assignment in the control word

Bit	Name	Bit	Name
0	Switch on	8	Pause/halt
1	Disable Voltage	9	reserved
2	Quick Stop	10	reserved
3	Enable Operation	11	reserved
4	Operation mode specific	12	reserved
5	Operation mode specific	13	Manufacturer-specific
6	Operation mode specific	14	Manufacturer-specific
7	Reset Fault (only effective for faults)	15	Manufacturer-specific

Commands in the control word

Command	Bit 7 Fault Reset	Bit 3 Enable Operation	Bit 2 Quick Stop	Bit 1 Disable Voltage	Bit 0 Switch On	Transitions
Shutdown	X	X	1	1	0	2, 6, 8
Switch on	X	X	1	1	1	3
Disable Voltage	X	X	X	0	X	7, 9, 10, 12
Quick Stop	X	X	0	1	X	7, 10, 11
Disable Operation	X	0	1	1	1	5
Enable Operation	X	1	1	1	1	4, 16
Fault Reset	1	X	X	X	X	15

Bits labeled **X** are irrelevant. **0** and **1** indicate the status of individual bits.

Mode-dependent bits in the control word

The following table shows the mode-dependent bits in the control word. Only manufacturer-specific modes are supported at present. The individual modes are set by Object 6060h Modes of operation.

Operation mode	No	Bit 4	Bit 5	Bit 6
Profile Position Mode (pp)	01h	new_setpoint	change_set_immediately	absolute/relative
Profile Velocity Mode (pv)	03h	reserved	reserved	reserved
Profile Torque Mode (tq)	04h	reserved	reserved	reserved
Homing Mode (hm)	06h	homing_operation_start	reserved	reserved
Interpolated Position Mode (ip)	07h		reserved	reserved
Cyclic synchronous position mode	08h	reserved	reserved	reserved

Description of the remaining bits in the control word

Bit 8: (Pause) If Bit 8 is set, then the drive halts (pauses) in all modes. The setpoints (speed for homing or jogging, motion task number, setpoints for digital mode) for the individual modes are retained.

Bit 9,10: These bits are reserved for the drive profile (DS402).

Bit 13, 14, 15: These bits are manufacturer-specific, and reserved at present.

20.4.3 State Machine Bits (status word)

Bit assignment in the status word

Bit	Name	Bit	Name
0	Ready to switch on	8	Manufacturer-specific (reserved)
1	Switched on	9	Remote (always 1)
2	Operation enable	10	Target reached
3	Fault	11	Internal limit active
4	Voltage enabled	12	Operation mode specific (reserved)
5	Quick stop	13	Operation mode specific (reserved)
6	Switch on disabled	14	Manufacturer-specific (reserved)
7	Warning	15	Manufacturer-specific (reserved)

States of the state machine

State	Bit 6 switch on disable	Bit 5 quick stop	Bit 3 fault	Bit 2 operation enable	Bit 1 switched on	Bit 0 ready to switch on
Not ready to switch on	0	X	0	0	0	0
Switch on disabled	1	X	0	0	0	0
Ready to switch on	0	1	0	0	0	1
Switched on	0	1	0	0	1	1
Operation enabled	0	1	0	1	1	1
Fault	0	X	1	0	0	0
Fault reaction active	0	X	1	1	1	1
Quick stop active	0	0	0	1	1	1

Bits labeled **X** are irrelevant. **0** and **1** indicate the status of individual bits.

Description of the remaining bits in the status word

Bit 4: voltage_enabled The DC-link voltage is present if this bit is set.

Bit 7: warning There are several possible reasons for Bit 7 being set and this warning being produced. The reason for this warning can be revealed by using the Object 20subindex manufacturer warnings.

Bit 9: remote is always set to 1, i.e. the drive can always communicate and be influenced via the RS232 - interface.

Bit 10: target_reached This is set when the drive has reached the target position.

Bit 11: internal_limit_active This bit specifies that a movement was or is limited. In different modes, different warnings cause the bit to be set.

20.5 Fixed PDO Mappings

Various ready-to-use mappings can be selected for cyclic data exchange via SDO's of the object 0x1C12 and 0x1C13. Using object 0x1C12 subindex 1 (Sync Manager 2 assignment), a fixed mapping for the cyclic command values can be set with the values 0x1701, 0x1702, 0x1720 to 0x1724. Using object 0x1C13 subindex 1 (Sync Manager 3 assignment), a fixed mapping for the cyclic actual values can be set via the data 0x1B01, 0x1B20 to 0x1B25.

Use the sequence below to select the fixed command value mapping 0x1701 via SDO's:

1. SDO write access to object 0x1C12Sub0 Data:0x00
2. SDO write access to object 0x1C12Sub1 Data:0x1701
3. SDO write access to object 0x1C12Sub0 Data:0x01

NOTE

Up to firmware version 1.8.x.x AKD.XML file, fixed mapping 0x1701 called out 0x6062sub0 as the "Position Command". From AKD PDMM firmware release 1.8.5.0, the AKD.XML will be changed to call out 0x60C1sub1 as the "Position Command" and an additional XML file called "AKD_TwinCAT.XML" will be added to support TwinCat 2x and older. In reality, SDO 0x6062sub0 is not supported in the AKD PDMM firmware but was called in the fixed mapping to support a TwinCat issue.

Position interface, supported fixed mappings:

0x1701	Position command value (4 bytes), Control word (2 bytes), total (6 bytes)
0x1720	Control Word (2 bytes), Interpolated position command value (4 bytes), Latch control word (2 bytes), Torque feed forward (2 bytes), Digital outputs (2 bytes)
0x1721	Interpolated position command value (4 bytes), Control Word (2 bytes), Torque feed forward (2 bytes)
0x1722	Control word (2 byte), Interpolated position command value (4 bytes), Latch control word (2 bytes), Torque feed forward (2 bytes), Digital outputs (2 bytes), max. torque (2 bytes)
0x1723	Control word (2 bytes), Interpolated position command value (4 bytes), Latch control word (2 bytes), Torque feed forward (2 bytes), Digital outputs (2 bytes), Reset of changed input information (2 bytes)
0x1724	Target position for cyclic synchronous position mode (4 bytes), Control word (2 byte), Torque feed forward (2 bytes)
0x1B01	Position actual value (4 bytes), Status word (2 bytes), total (6 bytes)
0x1B20	Position actual internal value (4 bytes), 2nd position feedback position (4 bytes), velocity actual value (4 bytes), digital inputs (4 bytes), following error (4 bytes), latch position positive (4 bytes), status word (2 bytes), torque actual value (2 bytes), latch status (2 bytes), analogue input value (2 bytes)
0x1B21	Position Actual Internal Value (4 bytes), Status word (2 bytes)
0x1B22	Position actual internal value (4 bytes), 2nd position feedback position (4 bytes), velocity actual value (4 bytes), digital inputs (4 bytes), following error (4 bytes), latch position negative (4 bytes), status word (2 bytes), torque actual value (2 bytes), latch status (2 bytes), analogue input value (2 bytes)
0x1B23	Position actual internal value (4 bytes), 2nd position feedback position (4 bytes), velocity actual value (4 bytes), digital inputs (4 bytes), following error (4 bytes), latch position positive / negative (4 bytes), status word (2 bytes), torque actual value (2 bytes), latch status (2 bytes), analogue input value (2 bytes)
0x1B24	Position actual value (4 bytes), status word (2 bytes)

0x1B25	Position actual internal value (4 bytes), 2nd position feedback position (4 bytes), latch position 2 positive / negative (4 bytes), digital inputs (4 bytes), following error (4 bytes), latch position 1 positive / negative (4 bytes), status word (2 bytes), torque actual value (2 bytes), latch status (2 bytes), analogue input value (2 bytes)
--------	---

Velocity interface, supported fixed mappings:

0x1702	Velocity command value (4 bytes), Control word (2 bytes), total (6 bytes)
--------	---

The objects, which are mapped into the fixed PDOs can be read via the subindices 1 to n of the above indices. The number of mapped entries is available by reading subindex 0 of the above indices.

Example:

A read access to object 1702 sub 0 gives a value of 2, a read on subindex 1 gives 0x60ff0020, on subindex 2 0x60400010. The meaning of these numbers can be seen in the CANopen manual or the flexible-mapping example (→ p. 926.).

20.6 Flexible PDO Mappings

In addition to the fixed PDO mapping the so-called flexible mapping of real-time objects is possible.

NOTE

Available objects for PDO mapping are listed in the object dictionaries ("Appendix" (→ p. 945))("Appendix" (→ p. 1)). All objects with the entry "yes" in column "PDO map." can be used.

Restrictions of flexible mapping:

- An odd length PDO is not allowed.
- In the Rx(=set-point)-direction the dummy-object 0x0002 sub 0 with a length of 8 bits can be used to make the PDO-length even.
- In the Tx(=actual value)-direction one sub-index of the manufacturer status object 0x2002 sub 1..4 can be used to guarantee the even length of the Tx-PDO.
- These special mappings may be used if the objects 0x6060 and 0x6061 have to be used in the mapping.
- The allowed PDOs have up to 32 bytes (Tx) or 22 bytes (Rx). They are built from smaller PDO modules with a maximum length of 8 bytes. These are built by using the mapping objects 0x1600 to 0x1603 and 0x1a00 to 0x1a03.

The configuration is similar to the described sequence for the fixed mappings:

1. The mapping selection is cleared (write 0 to object 0x1C12 sub 0 and 1C13 sub 0)
2. As the AKD PDMM - implementation is based on CANopen the real-time data are build from up to 4 PDOs with 8 bytes in both directions. These PDOs are built in the same way as in a CAN-drive with the objects 0x1600 - 0x1603 and 0x1A00 - 0x1A03. Unused PDOs must be cleared with writing 0 to the subindex 0.
3. SDO write access to object 0x1C12 sub 1 .. 4 with the PDOs (0x1600 .. 0x1603), that should be used in receive direction of the AKD PDMM (set point values).
4. SDO write access to object 0x1C13 sub 1 .. 4 with the PDOs (0x1A00 .. 0x1A03), that should be used in transmit direction of the AKD PDMM (actual values).
5. SDO write access to the objects 0x1C12 sub 0 and 0x1C13 sub 0 with the number of mapped PDOs in this direction.

See an example in chapter "Flexible PDO Mappings" (→ p. 923) .

The cyclically used data are visible in the PDO-assignment window for the Inputs and Outputs of the Sync Managers. Default setting are the fixed PDOs 0x1701 and 0x1B01 (visible contents when selected in the PDO list).

The screenshot shows the configuration interface for EtherCAT. On the left is a tree view of the system configuration. The main window is titled 'EtherCAT' and shows the 'PDO Assignment (0x1C12)' window. It contains two tables: 'Sync Manager' and 'PDO List'.

Sync Manager:

SM	Size	Type	Flags
0	512	MbxOut	
1	512	MbxIn	
2	6	Outputs	
3	6	Inputs	

PDO List:

Index	Size	Name	Flags	SM	SU
0x1A00	2.0	Inputs			0
0x1A01	0.0	Inputs			0
0x1A02	0.0	Inputs			0
0x1A03	0.0	Inputs			0
0x1B01	6.0	Inputs	F	3	0
0x1B20	32.0	Inputs	F		0
0x1B21	6.0	Inputs	F		0
0x1B22	32.0	Inputs	F		0
0x1B23	32.0	Inputs	F		0
0x1B24	6.0	Inputs	F		0
0x1600	2.0	Outputs			0

PDO Assignment (0x1C12):

<input type="checkbox"/>	0x1600	(excluded by 0x1701)
<input type="checkbox"/>	0x1601	(excluded by 0x1701)
<input type="checkbox"/>	0x1602	(excluded by 0x1701)
<input type="checkbox"/>	0x1603	(excluded by 0x1701)
<input checked="" type="checkbox"/>	0x1701	
<input type="checkbox"/>	0x1702	(excluded by 0x1701)
<input type="checkbox"/>	0x1703	(excluded by 0x1701)

PDO Content (0x1A00):

Index	Size	Offs	Name	Type	Default (hex)
0x6041:00	2.0	0.0	Status word	UINT	
		2.0			

Buttons: Download, PDO Assignment, PDO Configuration, Load PDO info from device, Sync Unit Assignment...

If the flexible mapping is required, the PDO configuration check box must be changed.

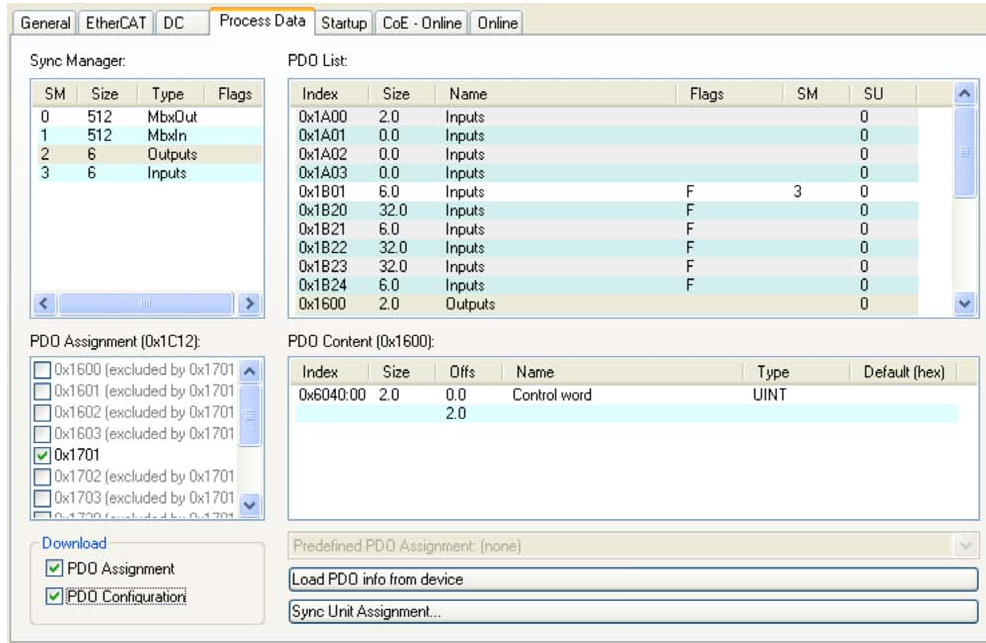

20.6.1 Example: Flexible PDO Mapping

For the flexible mapping of the Outputs the fixed mapping 0x1701 has to be switched off and up to 4 free-mappable PDOs (0x1600-0x1603) can be used instead. The maximum number of bytes for each of these PDOs is 8.

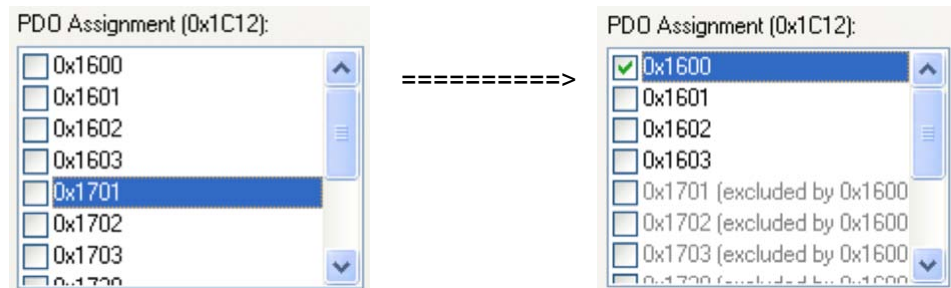

After that the default mapping of e.g. the PDO 0x1600 can be extended:

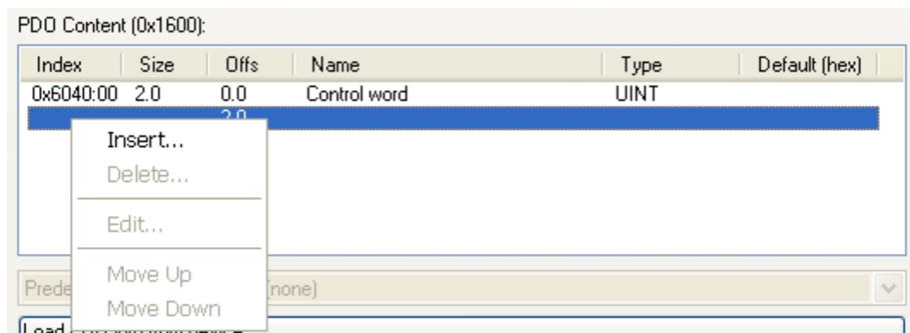

A list of possible objects for the mapping will be shown and a new entry can be chosen.

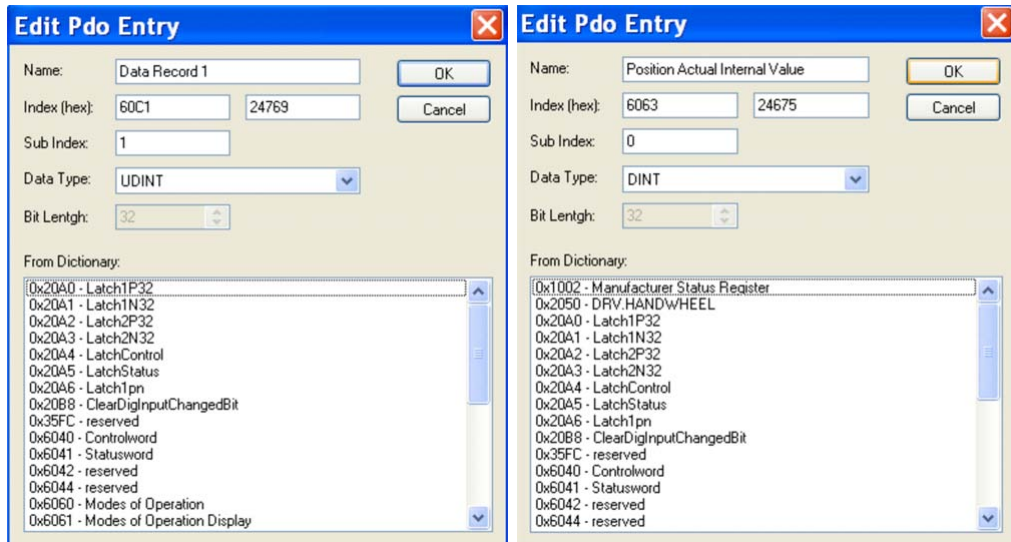

In this case the setpoint for the interpolated position mode is selected.

The same is valid for the Tx-PDO-direction. Here the value of the actual internal position is selected.

This results in the startup-SDO-list for this sample free-mapped-configuration.

Transition	Protocol	Index	Data	Comment
<PS>	CoE	0x1C12:00	0x00 (0)	clear sm pdos (0x1C12)
<PS>	CoE	0x1C13:00	0x00 (0)	clear sm pdos (0x1C13)
<PS>	CoE	0x1A00:00	0x00 (0)	clear pdo 0x1A00 entries
<PS>	CoE	0x1A00:01	0x60410010 (1614872592)	download pdo 0x1A00 entry
<PS>	CoE	0x1A00:02	0x60630020 (1617100832)	download pdo 0x1A00 entry
<PS>	CoE	0x1A00:00	0x02 (2)	download pdo 0x1A00 entr...
<PS>	CoE	0x1A01:00	0x00 (0)	clear pdo 0x1A01 entries
<PS>	CoE	0x1A02:00	0x00 (0)	clear pdo 0x1A02 entries
<PS>	CoE	0x1A03:00	0x00 (0)	clear pdo 0x1A03 entries
<PS>	CoE	0x1600:00	0x00 (0)	clear pdo 0x1600 entries
<PS>	CoE	0x1600:01	0x60400010 (1614807056)	download pdo 0x1600 entry
<PS>	CoE	0x1600:02	0x60C10120 (1623261472)	download pdo 0x1600 entry
<PS>	CoE	0x1600:00	0x02 (2)	download pdo 0x1600 entr...
<PS>	CoE	0x1601:00	0x00 (0)	clear pdo 0x1601 entries
<PS>	CoE	0x1602:00	0x00 (0)	clear pdo 0x1602 entries
<PS>	CoE	0x1603:00	0x00 (0)	clear pdo 0x1603 entries
<PS>	CoE	0x1C12:01	0x1600 (5632)	download pdo 0x1C12:01 i...
<PS>	CoE	0x1C12:00	0x01 (1)	download pdo 0x1C12 count
<PS>	CoE	0x1C13:01	0x1B01 (6913)	download pdo 0x1C13:01 i...
<PS>	CoE	0x1C13:00	0x01 (1)	download pdo 0x1C13 count
PS	CoE	0x6060:00	0x07 (7)	Opmode
PS	CoE	0x60C2:01	0x02 (2)	Cycle time
PS	CoE	0x60C2:02	0xFD (253)	Cycle exp

The meaning of the data (for example 0x60410010 in the mapping of 0x1A00 sub 1) is as follows:

- 0x6041 is the index of the DS402 status word
- 0x00 is the subindex of the DS402 status word
- 0x10 is the number of bits for this entry, i. e. 16 bits or 2 bytes.

If this shall be used in the NC, the interpolation set point position has to be linked from the axis to the NC-axis.

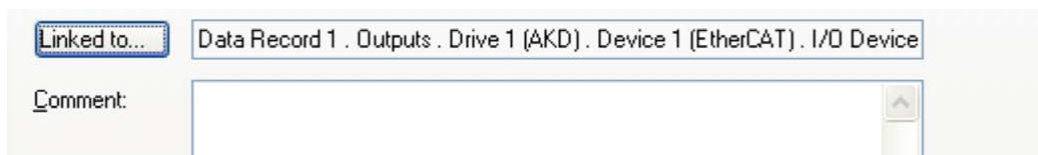
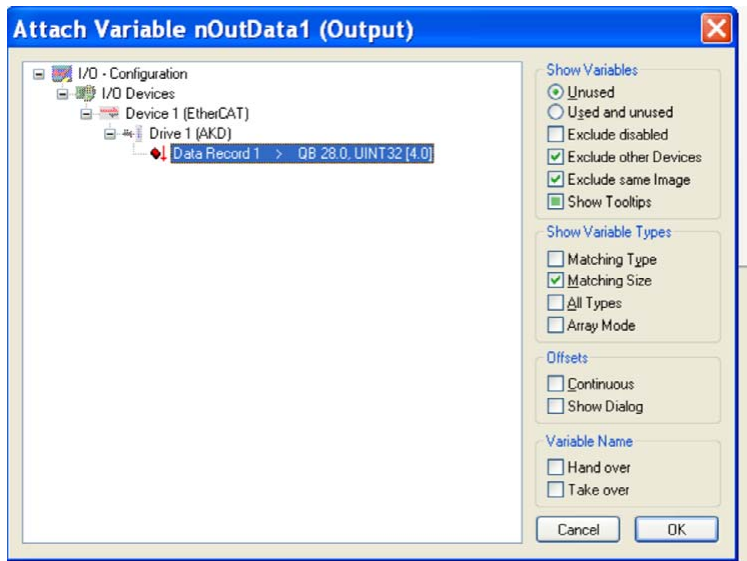
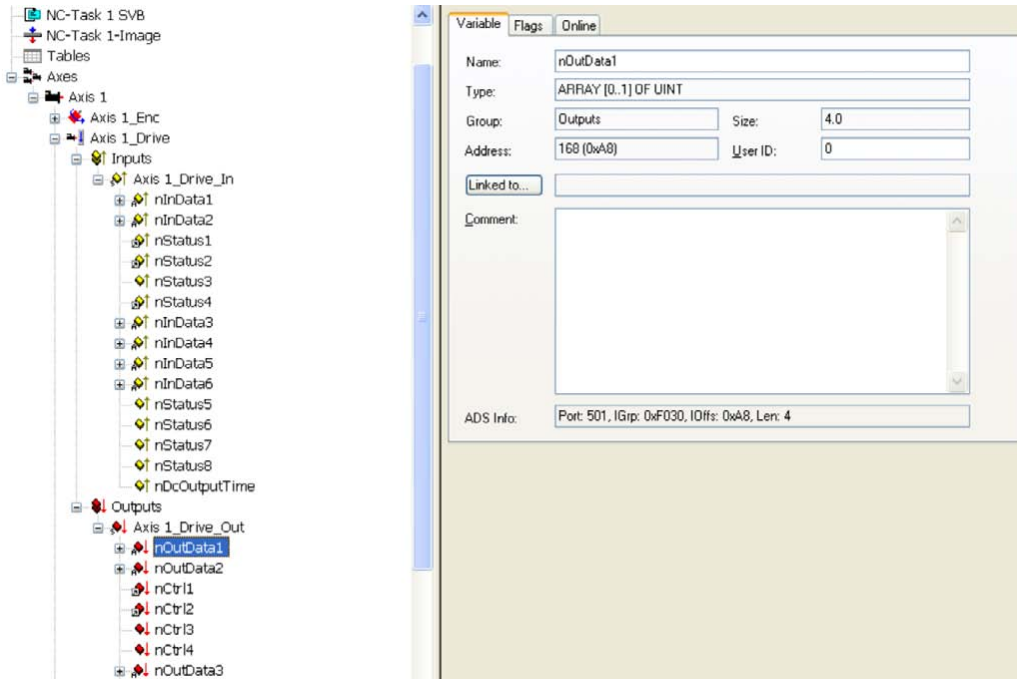

After doing this configuration the mapping can be activated as seen before in this document:

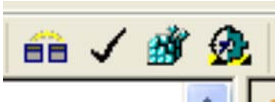

Now the NC-screen should show a position in the online window, which changes a bit in the last digits.

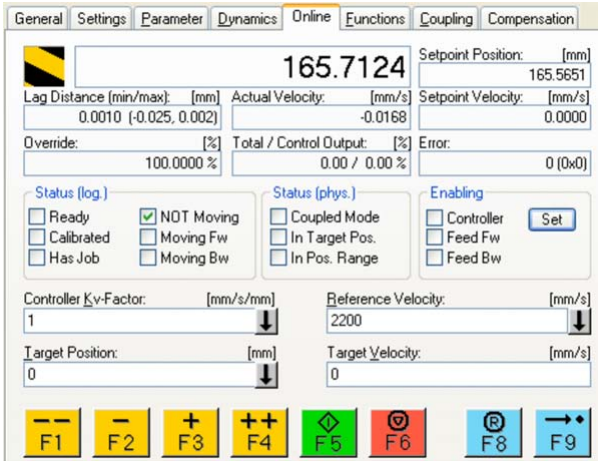

After enabling the power stage with the All-button, the drive can be moved via the jog-buttons or via the functions in the function menu.



20.7 Supported Cyclical Setpoint and Actual Values

Supported cyclical setpoint values

Name	CANopen object	Data type	Description
Target current	0x2071 sub 0	32 bit	scaled in mA
Latch Control word	0x20A4 sub 0	UINT16	
Clear digital Input Change Bit	0x20B8	16 bit	
Analog output value	0x3470 sub 3	16 bit	
External feedback position	0x3497 sub 0	32 bit	
CANopen control-word	0x6040 sub 0	UINT16	CANopen control word.
Modes of Operation	0x6060 sub 0	8 bit	DS402 opmode setpoint
Velocity Window	0x606D sub 0	16 bit	
Velocity Window Time	0x606E sub 0	16 bit	
Target Torque	0x6071 sub 0	16 bit	0.1% resolution
Maximum Torque	0x6072 sub 0	16 bit	
Target position	0x607A sub 0	INT32	Used in profile position mode / cyclic synchronous position mode
Profile position target velocity	0x6081 sub 0	32 bit	related to MT.V
Profile position target acc	0x6083 sub 0	32 bit	related to MT.ACC
Profile position target dec	0x6084 sub 0	32 bit	related to MT.DEC
Velocity feed forward	0x60B1 sub 0	32 bit	
Torque feed forward	0x60B2 sub 0	INT16	
Touch probe function	0x60B8	16 bit	
Position command value	0x60C1 sub 1	INT32	Interpolation data record in IP-mode
Digital outputs	0x60FE sub 1	UINT32	
Velocity command value	0x60FF sub 0	INT32	

Supported cyclical actual values

Name	CANopen object	Data type	Description
Position actual internal value	0x6063 sub 0	INT32	
Velocity actual value	0x606C sub 0	INT32	
CANopen status-word	0x6041 sub 0	UINT16	CANopen status word
Second position feedback	0x2050 sub 0	INT32	
Digital inputs	0x60FD sub 0	UINT32	
Following error actual value	0x60F4 sub 0	INT32	
Latch position positive edge	0x20A0 sub 0	INT32	
Torque actual value	0x6077 sub 0	INT16	
Latch status	0x20A5 sub 0	UINT16	
Analog input value	0x3470 sub 0	INT16	
Actual Current	0x2077 sub 0	32 bit	scaled in mA
Latch1 negative edge	0x20A1 sub 0	32 bit	
Latch2 Positive	0x20A2 sub 0	32 bit	
Latch2 Negative	0x20A3 sub 0	32 bit	
Latch1 positive/negative edge	0x20A6	32 bit	
Latch 2 positive/negative edge	0x20A7	32 bit	
Modes of Operation	0x6061	8 bit	DS402 opmode status
Position Actual Value	0x6064 sub 0	32 bit	WB/ DS402 scale units
Touch probe status	0x60B9 sub 0	16 bit	
Touch probe 1 positive edge pos	0x60BA sub 0	32 bit	
Touch probe 1 negative edge pos	0x60BB sub 0	32 bit	
Touch probe 2 positive edge pos	0x60BC sub 0	32 bit	
Touch probe 2 negative edge pos	0x60BD sub 0	32 bit	
Additional Pos actual value	0x60E4 sub 0	48 bit	
Additional Pos actual value	0x60E4 sub 1	32 bit	
Motor I2t	0x3427 sub 3	32 bit	
Analog output value	0x3470 sub 2	16 bit	
Analog Input & Output value	0x3470 sub 4	16 bit	
Manufacturer status register	0x1002 sub 0	32 bit	

20.8 Supported Operation Modes

CANopen mode of operation	AKD PDMM mode of operation	Description
Profile velocity	DRV.OPMODE 1 DRV.CMDSOURCE 1	0x6060Sub0 Data: 3 In this mode, the EtherCAT master sends cyclic velocity command values to the AKD PDMM.
Interpolated position	DRV.OPMODE 2 DRV.CMDSOURCE 1	0x6060Sub0 Data: 7 In this mode of operation the EtherCAT master sends cyclic position command values to the AKD PDMM. These command values are interpolated by the AKD PDMM according to the fieldbus sample rate.
Homing mode	DRV.OPMODE 2 DRV.CMDSOURCE 0	0x6060 sub 0 data : 6 In this mode an AKD PDMM-internal homing can be done.
Profile Position	DRV.OPMODE 2 DRV.CMDSOURCE 0	0x6060sub0 Data: 1 Uses motion task 0 to execute a point to point move
Torque	DRV.OPMODE 0 DRV.CMDSOURCE 1	0x6060sub0 Data: 4 Commands torque in % of drive peak torque
Cyclic Synchronous Position	DRV.OPMODE 2 DRV.CMDSOURCE 1	0x6060sub0 Data: 8 Master calculates move profile and commands motion with position points

20.9 Adjusting EtherCAT Cycle Time

The cycle time to be used in the drive for the cyclical setpoints and actual values can either be stored in the FBUS.SAMPLEPERIOD parameter in the amplifier or configured in the startup phase. This happens via SDO mailbox access to objects 60C2 subindex 1 and 2.

Subindex 2, known as the interpolation time index, defines the power of ten of the time value (e.g. -3 means 10⁻³ or milliseconds) while subindex 1, known as interpolation time units, gives the number of units (e.g. 4 means 4 units).

You can run a 2 ms cycle using various combinations. For example,

Index = -3, Units = 2 or

Index = -4, Units = 20 etc.

The FBUS.SAMPLEPERIOD parameter is counted in multiples of 62.5us microseconds within the device. This means, for example that 2 ms equates to FBUS.SAMPLEPERIOD value of 32.

20.10 Maximum Cycle Times depending on operation mode

The minimum cycle time for the drive is largely dependent on the drive configuration (second actual position value encoder latch functionality enabled and so on)

Interface	Cycle time AKD PDMM
Position	≥ 0.25 ms (≥ 250 μs)
Velocity	≥ 0.25 ms (≥ 250 μs)
Torque	≥ 0.25 ms (≥ 250 μs)

20.11 Synchronization

On all drives, the internal PLL is theoretically able to even out an average deviation of up to 4800 ppm in the cycle time provided by the master. The drive checks once per fieldbus cycle a counter within the drive internal FPGA, which is cleared by a Sync0 (Distributed clock) event. Depending of the counter value, the drive extends or decreases the 62.5 μ s MTS signal within the drive by a maximum of 300 ns.

The theoretical maximum allowed deviation can be calculated by using the following formula:

$$\max_{dev} = \frac{300[\text{ns}]}{62.5[\mu\text{s}]} \cdot 1,000,000 = 4800 [\text{ppm}]$$

The synchronization functionality within the drive can be enabled via setting bit 0 of the FBUS.PARAM02 parameter to high. Therefore FBUS.PARAM02 must be set to the value of 1. Furthermore the distributed clock functionality must be enabled by the EtherCAT master in order to activate cyclic Sync0 events.

20.11.1 Synchronization behavior with distributed clocks (DC) enabled

When the EtherCAT master enables distributed clocks, a distributed clock (DC) event is created in the AKD PDMM once per fieldbus cycle. An assigned 62.5 μ s real-time task in the AKD PDMM monitors the elapsed time between the DC events and the AKD PDMM System time and extends or reduces the 62.5 μ s strobe to the CPU as necessary.

The following fieldbus parameters are used for the synchronization feature:

1. FBUS.SYNCDIST = Expected time delay of the AKD PDMM PLL-code to the DC event.
2. FBUS.SYNCACT = Actual time delay of the AKD PDMM PLL-code to the DC event.
3. FBUS.PLLTHRESH = Number of consecutive successful synchronized PLL cycles of the AKD PDMM before the Drive is considered as synchronized.
4. FBUS.SYNCWND = Synchronization window in which the AKD PDMM is considered to be synchronized. The Drive is considered synchronized as long as the following statement is true is true for FBUS.PLLTHRESH consecutive cycles:

$$\text{FBUS.SYNCDIST} - \text{FBUS.SYNCWND} < \text{FBUS.SYNCACT} < \text{FBUS.SYNCDIST} + \text{FBUS.SYNCWND}$$

Example with a 4kHz fieldbus sample rate:

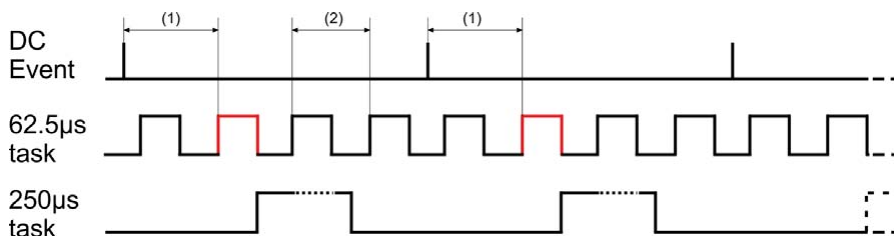

Explanation: The red-marked 62.5 μ s real-time task displays the AKD PDMM 62.5 μ s real-time task within one fieldbus cycle which is responsible for calling the AKD PDMM PLL-code. The time delay (1) shows the actual delay to the previous DC event, which is ideally close to the adjusted FBUS.SYNCDIST parameter. Depending on (1) the AKD PDMM slightly extends or reduce the 62.5 μ s IRQ generation of the high-priority real-time task in order to either increase or decrease the measured time delay to the DC event (1) for the next PLL cycle. The time distance (2) shows the 62.5 μ s \pm x[ms] realtime task of the AKD PDMM.

20.11.2 Synchronization behavior with distributed clocks (DC) disabled

The AKD PDMM fieldbus synchronization algorithm is similar to that used by Distributed Clocks. The difference is that the AKD PDMM synchronizes to a SyncManager2 event instead of the DC event. A SyncManager2 event is created when the EtherCAT Master sends a new package of command values to the drive while the network is in the Operational state. This occurs once per fieldbus cycle.

20.12 Latch Control Word and Latch Status Word

Latch Control word (2 Byte)

Bit	Value (bin)	Value (hex)	Description
0	00000000 00000001	zz01	Enable extern latch 1 (positive rise)
1	00000000 00000010	zz02	Enable extern latch 1 (negative rise)
2	00000000 00000100	zz04	Enable extern latch 2 (positive rise)
3	00000000 00001000	zz08	Enable extern latch 2 (negative rise)
4			
5-7			Reserve
8-12	00000001 00000000	01zz	Read external latch 1 (positive rise)
	00000010 00000000	02zz	Read external latch 1 (negative rise)
	00000011 00000000	03zz	Read external latch 2 (positive rise)
	00000100 00000000	04zz	Read external latch 2 (negative rise)
13-15			Reserve

Latch Status word (2 Byte)

Bit	Value (bin)	Value (hex)	Description
0	00000000 00000001	zz01	External latch 1 valid (positive rise)
1	00000000 00000010	zz02	External latch 1 valid (negative rise)
2	00000000 00000100	zz04	External latch 2 valid (positive rise)
3	00000000 00001000	zz08	External latch 2 valid (negative rise)
4			
5-7			Reserve
8-11	00000001 00000000	z1zz	Acknowledge value external latch 1 (positive rise)
	00000010 00000000	z2zz	Acknowledge value external latch 1 (negative rise)
	00000011 00000000	z3zz	Acknowledge value external latch 2 (positive rise)
	00000100 00000000	z4zz	Acknowledge value external latch 2 (negative rise)
12-15	00010000 00000000	1zzz	Zustand Digital Input 4
	00100000 00000000	2zzz	Zustand Digital Input 3

Bit	Value (bin)	Value (hex)	Description
	01000000 00000000	4zzz	Zustand Digital Input 2
	10000000 00000000	8zzz	Zustand Digital Input 1

20.13 Mailbox Handling

With EtherCAT, acyclical data traffic (object channel or SDO channel) is called mailbox.

NOTE

Available SDO objects are listed in the ("Appendix" (→ p. 945))("Appendix" (→ p. 1)).

This system is based around the master:

Mailbox Output:

The master (EtherCAT controller) sends data to the slave (drive). This is essentially a (read/write) request from the master. Mailbox output operates via Sync Manager 0.

Mailbox Input:

The slave (drive) sends data to the master (EtherCAT controller). The master reads the slave's response. Mailbox input operates via Sync Manager 1.

Timing diagram

The timing diagram illustrates the mailbox access process:



1. The EtherCAT master writes the mailbox request to the mail-out buffer.
2. On the next interrupt, the EtherCAT interface activates a Sync Manager 0 event (mailbox output event) in the AL event register.
3. The drive reads 16 bytes from the mail-out buffer and copies them to the internal mailbox output array.
4. The drive identifies new data in the internal mailbox output array and performs an SDO access to the object requested by the EtherCAT interface. The response from the drive is written to an internal mailbox input array.
5. The drive deletes all data in the internal mailbox output array so that a new mailbox access attempt can be made.
6. The drive copies the response telegram from the internal mailbox input array to the mail-in buffer of the EtherCAT interface.

20.13.1 Mailbox Output

An interrupt by the EtherCAT-interface with a Sync Manager 0 - Event starts a Mailbox Output Process. A 1 in the Mail Out Event-Bit of the AL Event register signalizes the drive, that the EtherCAT-interface wants to send a Mailbox message and that it has already stored the required data in the Mail Out Buffer. Now 16 Byte data are read by the drive with the IRQ process. The bytes are defined as follows

Address 0x1800								Address 0x180F							
0	1	2	3	4	5	6	7	8	9	10	11	12	13	14	15
CAN over EtherCAT specific data (CoE Header)								CAN specific data (standard CAN SDO)							
Byte 0	Length of the data (Low Byte)														
Byte 1	Length of the data (High Byte)														
Byte 2	Address (Low Byte)														
Byte 3	Address (High Byte)														
Byte 4	Bit 0 to 5: Channel Bit 6 to 7: Priority														
Byte 5	Bit 0 to 3: Type							1 = Reserved: ADS over EtherCAT 2 = Reserved: Ethernet over EtherCAT 3 = Can over EtherCAT...)							
	Bit 4 to 7: Reserved														
Byte 6	PDO Number (with PDO transmissions only, Bit 0 = LSB of the PDO number, see Byte 7 for MSB)														
Byte 7	Bit 0: MSB of the PDO number, see Byte 6														
	Bit 1 to 3: Reserved														
	Bit 4 to 7: CoE specific type							0: Reserved							
								1: Emergency message							
								2: SDO request							
								3: SDO answer							
								4: TXPDO							
								5: RxPDO							
								6: Remote transmission request of a TxPDO							
							7: Remote transmission request of a RxPDO								
							8...15: reserved								
Byte 8	Control-Byte in the CAN telegram:														
	write access:							0x23=4Byte, 0x27=3Byte, 0x2B=2Byte, 0x2F-F=1Byte							
	read access:							0x40							
Byte 9	Low Byte of the CAN object number (Index)														
Byte 10	High Byte of the CAN object number (Index)														
Byte 11	Subindex according to CANopen Specification for the drive														
Byte 12	Data with a write access (Low Byte)														
Byte 13	Data with a write access														
Byte 14	Data with a write access														

Byte 15	Data with a write access (High Byte)
---------	--------------------------------------

The drive answers every telegram with an answer in the Mailbox Input buffer.

20.13.2 Mailbox Input

The drive answers every CoE telegram with a 16 byte answer telegram in the Mailbox Input buffer. The bytes are defined as follows:

Address 0x1C00								Address 0x1C0F							
0	1	2	3	4	5	6	7	8	9	10	11	12	13	14	15
CAN over EtherCAT specific data (CoE Header)								CAN specific data (standard CAN SDO)							
Byte 0	Length of the data (Low Byte)														
Byte 1	Length of the data (High Byte)														
Byte 2	Address (Low Byte)														
Byte 3	Address (High Byte)														
Byte 4	Bit 0 to 5: Channel Bit 6 to 7: Priority														
Byte 5	Bit 0 to 3: Type							1 = Reserved: ADS over EtherCAT 2 = Reserved: Ethernet over EtherCAT 3 = Can over EtherCAT...							
	Bit 4 to 7: Reserved														
Byte 6	PDO Number (with PDO transmissions only, Bit 0 = LSB of the PDO number, see Byte 7 for MSB)														
Byte 7	Bit 0: MSB of the PDO number, see Byte 6														
	Bit 1 to 3: Reserved														
	Bit 4 to 7: CoE specific type							0: Reserved							
								1: Emergency message							
								2: SDO request							
								3: SDO answer							
								4: TXPDO							
								5: RxPDO							
								6: Remote transmission request of a TxPDO							
							7: Remote transmission request of a RxPDO								
							8... 15: reserved								
Byte 8	Control-Byte in the CAN telegram:														
	write access OK:							0x60							
	read access OK + length of answer:							0x43 (4 Byte), 0x47 (3 Byte), 0x4B (2Byte), 0x4F (1Byte)							
	error with read- or write access:							0x80							
Byte 9	Low Byte of the CAN object number (Index)														
Byte 10	High Byte of the CAN object number (Index)														
Byte 11	Subindex according to CANopen Specification for Kollmorgen drive														
Byte 12	Data (Low Byte)														

Byte 13	Data	error code Fehlercode according to CANopen Specification in case of an error
Byte 14	Data	data value of the object in case of successful read access
Byte 15	Data (High Byte)	

20.13.3 Example: Mailbox Access

In the example below, PDOs 0x1704 are mapped (see Chapter "Fixed PDO Mappings" (→ p. 921) "Fixed PDO Mappings"):

The master sends this mailbox output message:

Byte 0	0x0A	The next 10 Bytes contain data (Byte 2 to Byte 11)
Byte 1	0x00	The next 10 Bytes contain data (Byte 2 to Byte 11)
Byte 2	0x00	Address 0
Byte 3	0x00	Address 0
Byte 4	0x00	Channel 0 and Priority 0
Byte 5	0x03	CoE Object
Byte 6	0x00	PDO Number 0
Byte 7	0x20	PDO Number 0 and SDO-Request
Byte 8	0x2B	2 Byte write access
Byte 9	0x12	SDO-Object 0x1C12
Byte 10	0x1C	SDO-Object 0x1C12
Byte 11	0x01	Subindex 1
Byte 12	0x04	Data value 0x00001704
Byte 13	0x17	Data value 0x00001704
Byte 14	0x00	Data value 0x00001704
Byte 15	0x00	Data value 0x00001704

The drive returns the following message:

Byte 0	0x0E	The next 14 Bytes contain data (Byte 2 to Byte 15)
Byte 1	0x00	The next 14 Bytes contain data (Byte 2 to Byte 15)
Byte 2	0x00	Address 0
Byte 3	0x00	Address 0
Byte 4	0x00	Channel 0 and Priority 0
Byte 5	0x03	CoE Object
Byte 6	0x00	PDO Number 0
Byte 7	0x20	PDO Number 0 and SDO-Answer
Byte 8	0x60	Successful write access
Byte 9	0x12	SDO-Object 0x1C12
Byte 10	0x1C	SDO-Object 0x1C12
Byte 11	0x01	Subindex 1
Byte 12	0x00	Data value 0x00000000
Byte 13	0x00	Data value 0x00000000
Byte 14	0x00	Data value 0x00000000
Byte 15	0x00	Data value 0x00000000

20.14 Fieldbus Parameters

The AKD PDMM holds several fieldbus-specific, general purpose parameters. Some of them contain the following EtherCAT relevant data:

FBUS.PARAM02:

This parameter activates the synchronization feature of the AKD PDMM. The DC feature must be activated in order to allow the AKD PDMM to get synchronized with the master. A value of 1 enables the drive internal PLL functionality, a value of 0 deactivates this feature.

FBUS.PARAM03:

This parameter contains the Configured Station Alias address of the AKD PDMM. An EEPROM emulation write access to the Configured Station Alias address forces the AKD PDMM to store the drive parameters automatically using the DRV.NVSAVE command.

FBUS.PARAM04:

This parameter enables (1) or disables(0) the synchronization supervision of the CANOpen or EtherCAT fieldbus.

Default values for this parameter are as follows:

CANopen drive: disabled (0)

EtherCAT drive: enabled (1)

Synchronization supervision is active when FBUS.PARAM 04 = 1 and the first CANOpen Sync message or first EtherCAT frame is received. When more than three CANOpen sync messages or seven EtherCAT frames have not been received and the drive is enabled, fault F125 ("Synchronization lost"), occurs.

FBUS.PARAM05

Bit 0	1	Faults can only be reset using DS402 control word bit 7.
	0	The reset can also be done via telnet or digital input and the DS402 state machine reflects this condition.
Bit 1	1	The state of the hardware enable does not change the state machine state Operation Enable.
	0	If the state Operation Enable or Switched on is active it falls back to the state switched On Disabled, if the Hardware enable goes to 0.
Bit 2	1	EWV ¹ /Telnet can not software enable the drive, when CANopen/EtherCAT are Operational.
	0	EWV/Telnet can software enable the drive. NOTE: During commissioning this bit should be set to 1 to avoid influences to DS402 power stage state machine. The field bus should not be in operation as well to avoid influence to test functions of Workbench.
Bit 3	1	DS402-state machine is not influenced, if the software-enable is taken away via Telnet.
	0	DS402-state machine is influenced, if the software-enable is taken away via Telnet.
Bit 4	1	Scaling is done via special DS402 - objects (independent on units)
	0	Scaling for position, velocity and acceleration objects is done via UNIT parameters.

¹Embedded Workbench Views

Bit 5	1	FBUS.PARAM03 defines the station alias address if not 0. If FBUS.PARAM03 set to 0, the address will be taken from rotary switches instead, if they are not 0. The EtherCAT master has the ability to use the alias address, selected by the drive, or issue its own.
	0	The rotary switches define the station alias address if not 0. If the rotary switches are set to 0, the address will be taken from FBUS.PARAM03 instead, if it is not 0.
Bit 6	1	Bit 0 of parameter MT.CNTL (object 35B9 sub 0) can be accessed.
	0	Bit 0 of parameter MT.CNTL (object 35B9 sub 0) is exclusively used for DS402 controlword.
Bit 7		reserved
Bit 8	1	DS402-state SWITCHED ON means power stage disabled.
	0	DS402-state SWITCHED ON means power stage enabled.
Bit 9	1	SDO content of object 0x6063 is the same as PDO content.
	0	SDO content of object 0x6063 depends on AKD PDMM unit parameters.
Bit 10 (Bit 10 is active only, if Bit 8 is set)	1	State "Switch On" can be reached without the high-level voltage being active.
	0	State "Switch On" can only be reached when the high-level voltage is active; otherwise the drive will stay in "Ready to Switch On".

20.15 EEPROM Content

AKD PDMM has a built-in emulated EEPROM. This EEPROM can be read by the EtherCAT master to get some information about drive properties, like PDO-information, drive name, serial numbers and communication-specific attributes.

They are organized in categories. There are two manufacturer-specific categories implemented in the AKD PDMM:

- Category 0x0800: Holds a string with the model type in the format AKD PDMM-P00000-NxxC-0000
- Category 0x0801: Holds the firmware version in the format 0x_xx-xx-yyy

This page intentionally left blank.

21 Appendix

21.1 CANopen Emergency Messages and Error Codes

Emergency messages are triggered by internal equipment errors. They have a high ID-priority to ensure quick access to the bus. An emergency message contains an error field with pre-defined error/fault numbers (2 bytes), an error register (1byte), the error category (1 byte), and additional information. Error numbers 0000h to 7FFFh are defined in the communication or drive profile. Error numbers FF00h to FFFFh have manufacturer-specific definitions.

Error Code	Fault/Warning	Description
0x0000	0	Emergency error free.
0x1080	-	General Warning.
0x1081	-	General Error.
0x3110	F523	DC Bus link over voltage FPGA.
0x3120	F247	DC Bus link voltage exceed allowed thresholds.
0x3130	F503	DC Bus link capacitor overload.
0x3180	n503	Warning: DC Bus link capacitor overload.
0x3210	F501	DC Bus link over-voltage.
0x3220	F502	DC Bus Link under-voltage.
0x3280	n502	Warning: DC Bus Link under-voltage.
0x3281	n521	Warning: Dynamic Braking I ² T.
0x3282	F519	Regen short circuit.
0x3283	n501	Warning: DC Bus link over-voltage.
0x4210	F234	Excessive temperature, device (control board).
0x4310	F235	Excessive temperature, drive (heat sink).
0x4380	F236	Power temperature sensor 2 high.
0x4381	F237	Power temperature sensor 3 high.
0x4382	F535	Power board overtemperature.
0x4390	n234	Warning: Control temperature sensor 1 high.
0x4391	n235	Warning: Power temperature sensor 1 high.
0x4392	n236	Warning: Power temperature sensor 2 high.
0x4393	n237	Warning: Power temperature sensor 3 high.
0x4394	n240	Warning: Control temperature sensor 1 low.
0x4395	n241	Warning: Power temperature sensor 1 low.
0x4396	n242	Warning: Power temperature sensor 2 low.
0x4397	n243	Warning: Control temperature sensor 1 low.
0x4398	F240	Control temperature sensor 1 low.
0x4399	F241	Power temperature sensor 1 low.
0x439A	F242	Power temperature sensor 2 low.

Error Code	Fault/Warning	Description
0x439B	F243	Power temperature sensor 3 low.
0x5113	F512	5V0 under voltage.
0x5114	F505	1V2 under voltage.
0x5115	F507	2V5 under voltage.
0x5116	F509	3V3 under voltage.
0x5117	F514	+12V0 under voltage.
0x5118	F516	-12V0 under voltage.
0x5119	F518	Analog 3V3 under voltage.
0x5180	F504	1V2 over voltage.
0x5181	F506	2V5 over voltage.
0x5182	F508	3V3 over voltage.
0x5183	F510	5V0 over voltage.
0x5184	F513	+12V0 over voltage.
0x5185	F515	-12V0 over voltage.
0x5186	F517	Analog 3V3 over voltage.
0x5530	F105	Hardware memory, non-volatile memory stamp invalid.
0x5580	F106	Hardware memory, non-volatile memory data.
0x5590	F204	Control board EEPROM read failed.
0x5591	F205	Control board EEPROM corrupted serial num stamp.
0x5592	F206	Control board EEPROM corrupted serial num data.
0x5593	F207	Control board EEPROM corrupted parameter stamp.
0x5594	F208	Control board EEPROM corrupted parameter data.
0x5595	F219	Control board EEPROM write failed.
0x55A0	F209	Power board EEPROM read failed.
0x55A1	F210	Power board EEPROM corrupted serial num stamp.
0x55A2	F212	Power board EEPROM corrupted serial num data.
0x55A3	F213	Power board EEPROM corrupted parameter stamp.
0x55A4	F214	Power board EEPROM corrupted parameter data.
0x55A5	F230	Power board EEPROM write failed.
0x55A6	F232	Power board EEPROM invalid data.
0x55B0	F248	Option board EEPROM corrupted.
0x55B1	F249	Option board upstream checksum.
0x55B2	F250	Option board upstream checksum.
0x55B3	F251	Option board watchdog.
0x55B8	F252	Firmware and option board FPGA types are not compatible.
0x55B9	F253	Firmware and option board FPGA versions are not compatible.
0x55C0	F621	Control Board CRC fault.
0x55C1	F623	Power Board CRC fault.

Error Code	Fault/Warning	Description
0x55C2	F624	Power Board Watchdog fault.
0x55C3	F625	Power Board Communication fault.
0x55C4	F626	Power Board FPGA not configured.
0x55C5	F627	Control Board Watchdog fault.
0x55C6	n103	Warning: Resident FPGA .
0x55C7	n104	Warning: Operational FPGA .
0x6380	F532	Drive motor parameters setup incomplete.
0x7180	F301	Motor overheat.
0x7182	F305	Motor Brake open circuit.
0x7183	F306	Motor Brake short circuit.
0x7184	F307	Motor Brake applied during enable state.
0x7185	F436	EnDAT overheated.
0x7186	n301	Warning: Motor overheated.
0x7187	F308	Voltage exceeds motor rating.
0x7188	F560	Regen near capacity, could not prevent over voltage.
0x7189	F312	Brake released when it should be applied.
0x7305	F417	Broken wire in primary feedback.
0x7380	F402	Feedback 1 Analog signal amplitude default.
0x7381	F403	Feedback 1 EnDat communication fault.
0x7382	F404	Feedback 1 illegal hall state.
0x7383	F405	Feedback 1 BiSS watchdog.
0x7384	F406	Feedback 1 BiSS multi cycle.
0x7385	F407	Feedback 1 BiSS sensor.
0x7386	F408	Feedback 1 SFD configuration.
0x7387	F409	Feedback 1 SFD UART overrun.
0x7388	F410	Feedback 1 SFD UART frame.
0x7389	F412	Feedback 1 SFD UART parity.
0x738A	F413	Feedback 1 SFD transfer timeout.
0x738C	F415	Feedback 1 SFD mult. corrupt position.
0x738D	F416	Feedback 1 SFD Transfer incomplete.
0x738E	F418	Feedback 1 power supply fault.
0x738F	F401	Feedback 1 failed to set feedback.
0x7390	n414	Warning: SFD single corrupted position.
0x7391	F419	Encoder init procedure failed.
0x7392	F534	Failed to read motor parameters from feedback device.
0x7393	F421	SFD position sensor fault.
0x7394	F463	Tamagawa encoder: overheat.
0x7395	n451	Warning: Tamagawa encoder battery.

Error Code	Fault/Warning	Description
0x7396	n423	Warning: Non volatile memory error, multiturn overflow.
0x7398	F135	Homing is needed.
0x7399	F468	FB2.Source not set.
0x739A	F469	FB1.ENCRESES is not power of two.
0x739B	F423	Non volatile memory error, multiturn overflow.
0x739C	F467	Hiperface DSL fault.
0x739D	F452	Multiturn overflow not supported with this feedback.
0x739E	F465	Excessive shock detected by feedback device.
0x73A0	F453	Tamagawa encoder: communication timeout.
0x73A1	F454	Tamagawa encoder: communication transfer incomplete.
0x73A2	F456	Tamagawa encoder: communication CRC.
0x73A3	F457	Tamagawa encoder: communication start timeout.
0x73A4	F458	Tamagawa encoder: communication UART overrun.
0x73A5	F459	Tamagawa encoder: communication UART framing.
0x73A6	F460	Tamagawa encoder: over speed.
0x73A7	F461	Tamagawa encoder: contouring error.
0x73A8	F462	Tamagawa encoder: counting overflow.
0x73A9	F464	Tamagawa encoder: multiturn error.
0x73AA	F451	Tamagawa encoder: battery.
0x73B0	F486	Motor velocity exceeds emulated encoder maximum speed.
0x73B8	F420	FB3 EnDat communication fault.
0x73C5	F482	Commutation not initialized.
0x73C6	F483	Motor U phase missing.
0x73C7	F484	Motor V phase missing.
0x73C8	F485	Motor W phase missing.
0x73D0	F487	Wake and Shake. Validating positive movement failed.
0x73D1	F489	Wake and Shake. Validating negative movement failed.
0x73D2	F490	Wake and Shake. Validating commutation angle time out.
0x73D3	F491	Wake and Shake. Validating commutation angle moved too far.
0x73D4	F492	Wake and Shake. Validating commutation angle required more than MOTOR.ICONT.
0x73D5	F493	Invalid commutation detected, motor accelerates in wrong direction.
0x8130	F129	Life Guard Error or Heartbeat Error.
0x8180	n702	Warning: Fieldbus communication lost.
0x8280	n601	Warning: Modbus data rate is too high.
0x8311	F304	Motor foldback.
0x8331	F524	Drive foldback.

Error Code	Fault/Warning	Description
0x8380	n524	Warning: Drive foldback.
0x8381	n304	Warning: Motor foldback.
0x8382	n309	Warning: Motor I ² t load.
0x8383	n580	Warning: Using derivate of position when using sensorless feedback type in position mode.
0x8384	n581	Warning: Zero velocity when using induction sensorless feedback type in position mode.
0x8480	F302	Over speed.
0x8481	F703	Emergency timeout occurred while axis should disable.
0x8482	F480	Fieldbus command velocity too high.
0x8483	F481	Fieldbus command velocity too low.
0x8582	n107	Warning: Positive software position limit is exceeded.
0x8583	n108	Warning: Negative software position limit is exceeded.
0x8611	F439	Following error (user).
0x8685	F138	Instability during autotune.
0x8686	n151	Warning: Not enough distance to move; Motion Exception.
0x8687	n152	Warning: Not enough distance to move; Following Motion Exception.
0x8688	n153	Warning: Velocity Limit Violation, Exceeding Max Limit.
0x8689	n154	Warning: Following Motion Failed; Check Motion Parameters.
0x868A	n156	Warning: Target Position crossed due to Stop command.
0x86A0	n157	Warning: Homing Index pulse not found.
0x86A1	n158	Warning: Homing Reference Switch not found.
0x86A2	n159	Warning: Failed to set motion task parameters.
0x86A3	n160	Warning: Motion Task Activation Failed.
0x86A4	n161	Warning: Homing Procedure Failed.
0x86A5	F139	Target Position Over Short due to invalid Motion task activation.
0x86A6	n163	Warning: MT.NUM exceeds limit.
0x86A7	n164	Warning: Motion task is not initialized.
0x86A8	n165	Warning: Motion task target position is out.
0x86A9	n167	Warning: Software limit switch traversed.
0x86AA	n168	Warning: Invalid bit combination in the motion task control word.
0x86AB	n169	Warning: 1:1 profile cannot be triggered on the fly.
0x86AC	n170	Warning: Customer profile table is not initialized.
0x86AD	n171	Warning: Motion task activation is currently pending
0x86AE	n135	Warning: Homing is needed.
0x86AF	n174	Warning: Homing maximum distance exceeded
0x86B0	F438	Following error (numeric).
0x8780	F125	Fieldbus synchronization lost.

Error Code	Fault/Warning	Description
0x8781	n125	Warning: Fieldbus synchronization lost.
0x8AF0	n137	Warning: Homing and feedback mismatch.
0xFF00	F701	Fieldbus runtime.
0xFF01	F702	Fieldbus communication lost.
0xFF02	F529	Iu current offset limit exceeded.
0xFF03	F530	Iv current offset limit exceeded.
0xFF04	F521	Regen over power.
0xFF07	F525	Output over current.
0xFF08	F526	Current sensor short circuit.
0xFF09	F128	MPOLES/FPOLES not an integer.
0xFF0A	F531	Power stage fault.
0xFF0B	F602	Safe torque off.
0xFF0C	F131	Secondary feedback A/B line break.
0xFF0D	F130	Secondary feedback supply over current.
0xFF0E	F134	Secondary feedback illegal state.
0xFF0F	F245	External fault.
0xFF10	F136	Firmware and FPGA versions are not compatible.
0xFF11	F101	Firmware type mismatch.
0xFF12	n439	Warning: Following error (user).
0xFF13	n438	Warning: Following error (numeric).
0xFF14	n102	Warning: Operational FPGA is not a default FPGA.
0xFF15	n101	Warning: The FPGA is a laboratory FPGA.
0xFF16	n602	Warning: Safe torque off.
0xFF17	F132	Secondary feedback Z line break.
0xFF18	n603	Warning: OPMODE incompatible with CMDSOURCE.
0xFF19	n604	Warning: EMUEMODE incompatible with DRV.HANDWHEELSRC.

21.2 Object Dictionary

The following tables describe all objects reachable via SDO or PDO. (i.p. = in preparation).

Abbreviations:

U	= UNSIGNED	RO	= Read only
INT	= INTEGER	RW	= Read and Write
VisStr	= Visible String	WO	= Write only
		const	= Constant

21.2.1 Float Scaling

The scaling applied to objects which match floating-point parameters in EWV¹/Telnet are listed in the column "Float Scaling."

For example, index 607Ah is listed as 1:1 - this means that commanding a value of 1000 in SDO 607Ah is equivalent to entering MT.P 1000.000 in EWV. On the other hand, index 3598h is listed as 1000:1 - this means that commanding a value of 1000 in SDO 3598h is equivalent to entering IL.KP 1.000 in EWV.

A few parameters are listed as variable (var), because the scaling depends on other settings.

21.2.2 Effectiveness of PDO set-points

Some objects are having effect only in the state machine state "Operation Enabled", which is controlled by the DS402 control word. They are marked with an asterisk (*) at the PDO mapping.

21.2.3 Communication SDOs

Index	Sub-index	Data Type	Float Scale	Access	PDO map.	Description	ASCII object
1000h	0	U32		RO	no	Device type	—
1001h	0	U8		RO	no	Error register	—
1002h	0	U32		RO	yes	Manufacturer-specific status register	—
1003h		ARRAY				Pre-defined error field	—
1003h	0	U8		RW	no	Number of errors	—
1003h	1 to 10	U32		RO	no	standard error field	—
1005h	0	U32		RW	no	COB—ID SYNC message	—
1006h	0	U32		RW	no	Communication cycle period	—
1008h	0	VisStr		const	no	Manufacturer device name	—
1009h	0	VisStr		const	no	Manufacturer hardware version	—
100Ah	0	VisStr		const	no	Manufacturer software version	—
100Ch	0	U16		RW	no	Guard time	—
100Dh	0	U8		RW	no	Lifetime factor	—
1010h		ARRAY				Save parameters	—
1010h	0	U8		RO	no	highest sub-index	—
1010h	1	U32		RW	no	Saves the drive parameters from the RAM to the NV.	DRV.NVSAVE
1011h		ARRAY				Load parameters	—
1011h	0	U8		RO	no	highest sub-index	—

¹Embedded Workbench Views

Index	Sub-index	Data Type	Float Scale	Access	PDO map.	Description	ASCII object
1011h	1	U32		RW	no	Loads default parameters to the RAM.	DRV.RSTVAR
1012h	0	U32		RW	no	COB—ID for the Time Stamp	—
1014h	0	U32		RW	no	COB—ID for the Emergency Object	—
1016h		RECORD				Consumer heartbeat time	
1016h	0	U8		RO	no	highest sub-index	—
1016h	1	U32		RW	no	Consumer heartbeat time	—
1017h	0	U16		RW	no	Producer heartbeat time	—
1018h		RECORD				Identity Object	—
1018h	0	U8		RO	no	highest sub-index	—
1018h	1	U32		RO	no	Vendor ID	—
1018h	2	U32		RO	no	Product Code	—
1018h	3	U32		RO	no	Revision number	—
1018h	4	U32		RO	no	Serial number	—
1026h		ARRAY				OS prompt	—
1026h	0	U8		RO	no	highest sub-index	—
1026h	1	U8		WO	no	StdIn	—
1026h	2	U8		RO	no	StdOut	—
1400h		RECORD				RXPDO1 communication parameter	—
1400h	0	U8		RO	no	highest sub-index	—
1400h	1	U32		RW	no	RXPDO1 COB — ID	—
1400h	2	U8		RW	no	Transmission type RXPDO1	—
1401h		RECORD				RXPDO2 communication parameter	—
1401h	0	U8		RO	no	highest sub-index	—
1401h	1	U32		RW	no	RXPDO2 COB—ID	—
1401h	2	U8		RW	no	Transmission type RXPDO2	—
1402h		RECORD				RXPDO3 communication parameter	—
1402h	0	U8		RO	no	highest sub-index	—
1402h	1	U32		RW	no	RXPDO3 COB—ID	—
1402h	2	U8		RW	no	Transmission type RXPDO3	—
1403h		RECORD				RXPDO4 communication parameter	—
1403h	0	U8		RO	no	highest sub-index	—
1403h	1	U32		RW	no	RXPDO4 COB—ID	—
1403h	2	U8		RW	no	Transmission type RXPDO4	—
1600h		RECORD				RXPDO1 mapping parameter	—
1600h	0	U8		RO	no	highest sub-index	—
1600h	1 to 8	U32		RW	no	Mapping for n—th application object	—
1601h		RECORD				RXPDO2 mapping parameter	—
1601h	0	U8		RO	no	highest sub-index	—
1601h	1 to 8	U32		RW	no	Mapping for n—th application object	—
1602h		RECORD				RXPDO3 mapping parameter	—
1602h	0	U8		RO	no	highest sub-index	—

Index	Sub-index	Data Type	Float Scale	Access	PDO map.	Description	ASCII object
1602h	1 to 8	U32		RW	no	Mapping for n—th application object	—
1603h		RECORD				RXPDO4 mapping parameter	—
1603h	0	U8		RO	no	highest sub-index	—
1603h	1 to 8	U32		RW	no	Mapping for n—th application object	—
1800h		RECORD				TXPDO1 communication parameter	—
1800h	0	U8		RO	no	highest sub-index	—
1800h	1	U32		RW	no	TXPDO1 COB—ID	—
1800h	2	U8		RW	no	Transmission type TXPDO1	—
1800h	3	U16		RW	no	Inhibit time	—
1800h	4	U8		const	no	reserved	—
1800h	5	U16		RW	no	Event timer	—
1801h		RECORD				TXPDO2 communication parameter	—
1801h	0	U8		RO	no	highest sub-index	—
1801h	1	U32		RW	no	TXPDO2 COB—ID	—
1801h	2	U8		RW	no	Transmission type TXPDO2	—
1801h	3	U16		RW	no	Inhibit time	—
1801h	4	U8		const	no	reserved	—
1801h	5	U16		RW	no	Event timer	—
1802h		RECORD				TXPDO3 communication parameter	—
1802h	0	U8		RO	no	highest sub-index	—
1802h	1	U32		RW	no	TXPDO3 COB—ID	—
1802h	2	U8		RW	no	Transmission type TXPDO3	—
1802h	3	U16		RW	no	Inhibit time	—
1802h	4	U8		const	no	reserved	—
1802h	5	U16		RW	no	Event timer	—
1803h		RECORD				TXPDO4 communication parameter	—
1803h	0	U8		RO	no	highest sub-index	—
1803h	1	U32		RW	no	TXPDO4 COB—ID	—
1803h	2	U8		RW	no	Transmission type TXPDO4	—
1803h	3	U16		RW	no	Inhibit time	—
1803h	4	U8		const	no	reserved	—
1803h	5	U16		RW	no	Event timer	—
1A00h		RECORD				Mapping parameter TXPDO1	—
1A00h	0	U8		RO	no	highest sub-index	—
1A00h	1 to 8	U32		RW	no	Mapping for n—th application object	—
1A01h		RECORD				Mapping parameter TXPDO2	—
1A01h	0	U8		RO	no	highest sub-index	—
1A01h	1 to 8	U32		RW	no	Mapping for n—th application object	—
1A02h		RECORD				Mapping parameter TXPDO3	—
1A02h	0	U8		RO	no	highest sub-index	—
1A02h	1 to 8	U32		RW	no	Mapping for n—th application object	—

Index	Sub-index	Data Type	Float Scale	Access	PDO map.	Description	ASCII object
1A03h		RECORD				Mapping parameter TXPDO4	—
1A03h	0	U8		RO	no	highest sub-index	—
1A03h	1 to 8	U32		RW	no	Mapping for n—the application object	—
1C12h		ARRAY		RW	no	RxPDO assign	—
1C12h	0	U8		RO	no	highest sub-index	—
1C13h	1 to 4	U8		RW	no	Subindex 001..004	—
1C13h		ARRAY		RW	no	TxPDO assign	—
1C13h	0	U8		RO	no	highest sub-index	—
1C13h	1 to 4	U8		RW	no	Subindex 001..004	—

21.2.4 Manufacturer specific SDOs

Objects 2000h to 3999h

Index	Sub-index	Data Type	Float Scale	Access	PDO map.	Description	ASCII object
2000h		ARRAY				System Warnings	—
2000h	0	U8		RO	no	highest sub-index	—
2000h	1	U32		RO	no	System Warning 1	DRV.WARNING1
2000h	2	U32		RO	no	System Warning 2	DRV.WARNING2
2000h	3	U32		RO	no	System Warning 3	DRV.WARNING3
2001h		ARRAY				System Faults	—
2001h	0	U8		RO	no	highest sub-index	—
2001h	1	U32		RO	no	System Fault 1	DRV.FAULT1
2001h	2	U32		RO	no	System Fault 2	DRV.FAULT2
2001h	3	U32		RO	no	System Fault 3	DRV.FAULT3
2001h	4	U32		RO	no	System Fault 4	DRV.FAULT4
2001h	5	U32		RO	no	System Fault 5	DRV.FAULT5
2001h	6	U32		RO	no	System Fault 6	DRV.FAULT6
2001h	7	U32		RO	no	System Fault 7	DRV.FAULT7
2001h	8	U32		RO	no	System Fault 8	DRV.FAULT8
2001h	9	U32		RO	no	System Fault 9	DRV.FAULT9
2001h	A	U32		RO	no	System Fault 10	DRV.FAULT10
2002h		ARRAY				Manufacturer status bytes	—
2002h	0	U8		RO	no	highest sub-index	—
2002h	1	U8		RO	yes	Manufacturer status bytes 1	—
2002h	2	U8		RO	yes	Manufacturer status bytes 2	—
2002h	3	U8		RO	yes	Manufacturer status bytes 3	—
2002h	4	U8		RO	yes	Manufacturer status bytes 4	—
2011h		VAR		RO		DRV.RUNTIME in seconds	DRV.RUNTIME
2012h		ARRAY				Fault history: Fault numbers	DRV.FAULTHIST
2012h	0	U8		RO	no	highest sub-index	—
2012h	1 to 20	U32		RO	no	Nth-latest entry in fault number list of fault history table	—
2013h		ARRAY				Fault history: Time stamps	DRV.FAULTHIST
2013h	0	U8		RO	no	highest sub-index	—
2013h	1 to 20	U32		RO	no	Nth-latest entry in fault time stamp list of fault history table	—
2014h		ARRAY				Mask TxPDO Channel 1	—
2014h	1	U32		RW	no	Mask (Byte 0..3)	—
2014h	2	U32		RW	no	Mask (Byte 4..7)	—
2015h		ARRAY				Mask TxPDO Channel 2	—
2015h	1	U32		RW	no	Mask (Byte 0..3)	—
2015h	2	U32		RW	no	Mask (Byte 4..7)	—
2016h		ARRAY				Mask TxPDO Channel 3	—
2016h	1	U32		RW	no	Mask (Byte 0..3)	—
2016h	2	U32		RW	no	Mask (Byte 4..7)	—
2017h		ARRAY				Mask TxPDO Channel 4	—
2017h	1	U32		RW	no	Mask (Byte 0..3)	—
2017h	2	U32		RW	no	Mask (Byte 4..7)	—
2018h		ARRAY				Firmware version	—

Index	Sub-index	Data Type	Float Scale	Access	PDO map.	Description	ASCII object
2018h	0	U16		const	no	highest sub-index	—
2018h	1	U16		const	no	Major version	—
2018h	2	U16		const	no	Minor version	—
2018h	3	U16		const	no	Revision	—
2018h	4	U16		const	no	Branch version	—
2026h		ARRAY				ASCII Channel	—
2026h	0	U8		RO	no	highest sub-index	—
2026h	1	VisStr		WO	no	Command	—
2026h	2	VisStr		RO	no	Response	—
2031h	0	VisStr		RW	no	Drive Name, length 10 bits	DRV.NAME
2032h	0	VisStr		RW	no	Drive custom identifier string, length 32 byte	DRV.CUSTOM-IDENTIFIER
204Ch		ARRAY				pv scaling factor	—
204Ch	0	U8		RO	no	highest sub-index	—
204Ch	1	INT32		RW	no	pv scaling factor numerator	—
204Ch	2	INT32		RW	no	pv scaling factor denominator	—
2050h	0	INT32	1:1	RO	yes	Position, secondary feedback	DRV.HANDWHEEL
2071h	0	INT32		RW	yes*	Target current	-
2077h	0	INT32		RO	yes	Current actual value	-
20A0h	0	INT32	var	RO	yes	Latch position 1, positive edge	CAP0.PLFB , CAP0.T
20A1h	0	INT32	var	RO	yes	Latch position 1, negative edge	CAP0.PLFB , CAP0.T
20A2h	0	INT32	var	RO	yes	Latch position 2, positive edge	CAP1.PLFB , CAP1.T
20A3h	0	INT32	var	RO	yes	Latch position 2, negative edge	CAP1.PLFB , CAP1.T
20A4h	0	U16		RW	yes	Latch control register	—
20A5h	0	U16		RW	yes	Latch status register	—
20A6h	0	INT32	var	RO	yes	Gets captured position value	CAP0.PLFB
20A7h	0	INT32	var	RO	yes	Gets captured position value	CAP1.PLFB
20B8h	0	U16		RW	yes	Clear changed digital input information	—
3405h		ARRAY				VL.ARTYPE	—
3405h	0	U8		RO	no	highest sub-index	—
3405h	1	U8		RW	no	Calculation method for BiQuad filter 1	VL.ARTYPE1
3405h	2	U8		RW	no	Calculation method for BiQuad filter 2	VL.ARTYPE2
3405h	3	U8		RW	no	Calculation method for BiQuad filter 3	VL.ARTYPE3
3405h	4	U8		RW	no	Calculation method for BiQuad filter 4	VL.ARTYPE4
3406h		ARRAY				VL BiQuad	—
3406h	0	U8		RO	no	highest sub-index	—
3406h	1	U32	1000:1	RW	no	Natural frequency of pole of anti-resonance (AR) filter 1	VL.ARPF1
3406h	2	U32	1000:1	RW	no	Natural frequency of pole of anti-resonance (AR) filter 2	VL.ARPF2

Index	Sub-index	Data Type	Float Scale	Access	PDO map.	Description	ASCII object
3406h	3	U32	1000:1	RW	no	Natural frequency of pole of anti-resonance (AR) filter 3	VL.ARPF3
3406h	4	U32	1000:1	RW	no	Natural frequency of pole of anti-resonance (AR) filter 4	VL.ARPF4
3406h	5	U32	1000:1	RW	no	Q of pole of anti-resonance (AR) filter 1	VL.ARPQ1
3406h	6	U32	1000:1	RW	no	Q of pole of anti-resonance (AR) filter 2	VL.ARPQ2
3406h	7	U32	1000:1	RW	no	Q of pole of anti-resonance (AR) filter 3	VL.ARPQ3
3406h	8	U32	1000:1	RW	no	Q of pole of anti-resonance (AR) filter 4	VL.ARPQ4
3406h	9	U32	1000:1	RW	no	Natural frequency of zero of anti-resonance (AR) filter 1	VL.ARZF1
3406h	A	U32	1000:1	RW	no	Natural frequency of zero of anti-resonance (AR) filter 2	VL.ARZF2
3406h	B	U32	1000:1	RW	no	Natural frequency of zero of anti-resonance (AR) filter 3	VL.ARZF3
3406h	C	U32	1000:1	RW	no	Natural frequency of zero of anti-resonance (AR) filter 4	VL.ARZF4
3406h	D	U32	1000:1	RW	no	Q of zero of anti-resonance filter 1	VL.ARZQ1
3406h	E	U32	1000:1	RW	no	Q of zero of anti-resonance filter 2	VL.ARZQ2
3406h	F	U32	1000:1	RW	no	Q of zero of anti-resonance filter 3	VL.ARZQ3
3406h	10	U32	1000:1	RW	no	Q of zero of anti-resonance filter 4	VL.ARZQ4
3407h		STRUCT				Velocity Filter	—
3407h	0	U8		RO	no	highest sub-index	—
3407h	1	INT32	1000:1	RW	no	10 Hz filtered VL.FB	VL.FBFILTER
3407h	2	U32	1000:1	RW	no	Gain for the velocity feed-forward	VL.KVFF
3407h	3	U32		RW	no	Gain for the acceleration feed-forward	VL.KBUSFF
3407h	4	U32	1:1	RW	no	Sets the velocity error	VL.ERR
3412h	0	INT8		RW	no	Type of regen resistor	REGEN.TYPE
3414h	0	U8		RW		Returns and sets the regen resistor fault level temperature.	REGEN.WATTEXT
3415h	0	U32	1000:1	RO	no	Thermal regen resistor time constant	REGEN.TEXT
3416h	0	U32		RO	no	Gets regen resistor's calculated power	REGEN.POWER
3417h	0	U32		RO	no	Returns a filtered version of 3416h	REGEN.POWER-FILTERED
3420h	0	U16	1000:1	RW	no	Sets the foldback fault level.	IL.FOLDFTHRESH
3421h	0	U32	1000:1	RW	no	Sets the user value for the foldback fault level.	IL.FOLDFTHRESHU
3422h	0	U32	1000:1		no	Sets friction compensation value.	IL.FRICTION

Index	Sub-index	Data Type	Float Scale	Access	PDO map.	Description	ASCII object
3423h	0	INT32	1000:1		no	A constant current command added to compensate for gravity.	IL.OFFSET
3424h	0	U16			no	Enables/disables the integrator part of the PI loop.	IL.INTEN (Password Protected)
3425h	0	U32	1000:1	RO	no	Reads the overall foldback current limit	IL.IFOLD
3426h	0	U32	1000:1	RW	no	Sets current loop acceleration feedforward gain value	IL.KACFF
3427h		RECORD				Motor protection parameters	—
3427h	0	U8		RO	no	highest sub-index	—
3427h	1	U8		RW	no		IL.MIMODE
3427h	2	U8		RW	no		IL.MI2TWTRESH
3427h	3	U32		RW	yes		IL.MI2T
3430h	0	U8		RW	no	Sets the direction for absolute motion tasks.	PL.MODPDIR
3431h	0	U16		RW	no	Sets the motion task in the drive	MT.SET
3440h		ARRAY				Controlled stop parameters	—
3440h	0	U8		RO	no	highest sub-index	—
3440h	1	U32	1:1	RW	no	Sets the deceleration value for a controlled stop.	CS.DEC
3440h	2	U32	1:1	RW	no	Sets the velocity threshold for a controlled stop.	CS.VTHRESH
3440h	3	U32		RW	no	Sets the time value for the drive velocity to be within CS.VTHRESH.	CS.TO
3441h	0	U8		RO	no	Controlled stop state	CS.STATE
3443h	0	U16		RO	no	Returns the possible reason for a drive disable	DRV.DIS
3444h	0	U16	1000:1	RO	no	Maximum current for dynamic braking	DRV.DBILIMIT
3445h	0	U32		RO	no	Emergency timeout for braking	DRV.DISTO
3450h	0	U8		WO	no	Release or enable brake	MOTOR.BRAKERLS
3451h	0	U8		RW	no	Determines which drive parameters are calculated automatically.	MOTOR.AUTASET
3452h	0	U16		RW	no	Sets the motor maximum voltage	MOTOR.VOLTMAX
3453h	0	U32		RW	no	Sets the motor temperature warning level	MOTOR.TEMPWARN
3454h	0	U32	1000:1	RW	no	Sets the thermal constant of the motor coil	MOTOR.CTF0
3455h	0	U32	1000:1	RW	no	Sets the line-to-line motor Lq	MOTOR.LQLL
3456h	0	U32	1000:1	RW	no	Sets the stator winding resistance phase-phase in ohms	MOTOR.R
3457h		RECORD				Induction Motor parameter	—
3457h	0	U8		RO	no	highest sub-index	—

Index	Sub-index	Data Type	Float Scale	Access	PDO map.	Description	ASCII object
3457h	1	INT32	1000:1	RW	no	Configuration of induction motor's rated velocity.	MOTOR.VRATED
3457h	2	U16		RW	no	Configuration of induction motor's rated voltage.	MOTOR.VOLTRATED
3457h	3	U16		RW	no	Sets the minimum voltage for V/f Control.	MOTOR.VOLTMIN
345Ah		ARRAY				Brake Control	—
345Ah	0	U8		RO	no	highest sub-index	—
345Ah	1	U16		RW	yes	Brake Control Command	—
345Ah	2	U16		RO	yes	Brake Status Response.	—
3460h		RECORD				Capture engines parameters	—
3460h	0	U8		RO	no	highest sub-index	—
3460h	1	U8		RW	no	Specifies the trigger source for the position capture.	CAP0.TRIGGER
3460h	2	U8		RW	no	Specifies the trigger source for the position capture.	CAP1.TRIGGER
3460h	3	U8		RW	no	Selects the captured value.	CAP0.MODE
3460h	4	U8		RW	no	Selects the captured value.	CAP1.MODE
3460h	5	U8		RW	no	Controls the precondition logic.	CAP0.EVENT
3460h	6	U8		RW	no	Controls the precondition logic.	CAP1.EVENT
3460h	7	U8		RW	no	Selects the capture precondition edge.	CAP0.PREEDGE
3460h	8	U8		RW	no	Selects the capture precondition edge.	CAP1.PREEDGE
3460h	9	U8		RW	no	Sets the precondition trigger.	CAP0.PRESELECT
3460h	A	U8		RW	no	Sets the precondition trigger.	CAP1.PRESELECT
3460h	B	U8		RW	no	Selects the feedback source for the capture engine 0.	CAP0.FBSOURCE
3460h	C	U8		RW	no	Selects the feedback source for the capture engine 1.	CAP1.FBSOURCE
3470h		RECORD					—
3470h	0	U8		RO	no	highest sub-index	—
3470h	1	INT8		RW	no	Sets the analog output mode.	AOUT.MODE
3470h	2	INT16	1000:1	RW	yes	Reads the analog output value.	AOUT.VALUE
3470h	3	INT16	1000:1	RW	yes	Reads and writes the analog output value.	AOUT.VALUEU
3470h	4	INT16	1000:1	RO	yes	Reads the value of the analog input signal.	AIN.VALUE
3470h	5	U32	1000:1	RW	no	Sets velocity scale factor for analog output	AOUT.VSCALE
3471h	0	U32	1:1	RW	no	Sets the analog position scale factor	AOUT.PSCALE
3472h	0	U32	1:1	RW	no	Sets analog pscale factor	AIN.PSCALE
3474h		ARRAY				DINx.PARAM	—
3474h	0	U8		RO	no	highest sub-index	—
3474h	1	U32		RW	no	Lower 32-bit part of input parameter 1	DIN1.PARAM

Index	Sub-index	Data Type	Float Scale	Access	PDO map.	Description	ASCII object
3474h	2	U32		RW	no	Lower 32-bit part of input parameter 2	DIN2.PARAM
3474h	3	U32		RW	no	Lower 32-bit part of input parameter 3	DIN3.PARAM
3474h	4	U32		RW	no	Lower 32-bit part of input parameter 4	DIN4.PARAM
3474h	5	U32		RW	no	Lower 32-bit part of input parameter 5	DIN5.PARAM
3474h	6	U32		RW	no	Lower 32-bit part of input parameter 6	DIN6.PARAM
3474h	7	U32		RW	no	Lower 32-bit part of input parameter 7	DIN7.PARAM
3474h	8	U32		RW	no	Higher 32-bit part of input parameter 1	DIN1.PARAM
3474h	9	U32		RW	no	Higher 32-bit part of input parameter 2	DIN2.PARAM
3474h	A	U32		RW	no	Higher 32-bit part of input parameter 3	DIN3.PARAM
3474h	4	U32		RW	no	Higher 32-bit part of input parameter 1	DIN1.PARAM
3474h	5	U32		RW	no	Higher 32-bit part of input parameter 2	DIN2.PARAM
3474h	6	U32		RW	no	Higher 32-bit part of input parameter 3	DIN3.PARAM
3474h	B	U32		RW	no	Higher 32-bit part of input parameter 4	DIN4.PARAM
3474h	C	U32		RW	no	Higher 32-bit part of input parameter 5	DIN5.PARAM
3474h	D	U32		RW	no	Higher 32-bit part of input parameter 6	DIN6.PARAM
3474h	E	U32		RW	no	Higher 32-bit part of input parameter 7	DIN7.PARAM
3475h		ARRAY				DOUTx.PARAM	—
3475h	0	U8		RO	no	highest sub-index	—
3475h	1	U32		RW	no	Lower 32-bit part of output parameter 1	DOUT1.PARAM
3475h	2	U32		RW	no	Lower 32-bit part of output parameter 2	DOUT2.PARAM
3475h	3	U32		RW	no	Higher 32-bit part of output parameter 1	DOUT1.PARAM
3475h	2	U32		RW	no	Higher 32-bit part of output parameter 1	DOUT1.PARAM
3475h	4	U32		RW	no	Higher 32-bit part of output parameter 2	DOUT2.PARAM
3480h	0	U32	1000:1	RW	no	Integral gain of position regulator PID loop	PL.KI
3481h		ARRAY				PL.INTMAX	—
3481h	0	U8		RO	no	highest sub-index	—
3481h	1	U32	1:1	RW	no	Input saturation	PL.INTINMAX
3481h	2	U32	1:1	RW	no	Output saturation	PL.INTOUTMAX

Index	Sub-index	Data Type	Float Scale	Access	PDO map.	Description	ASCII object
3482h	0	INT32	1:1	RO	no	Maximum value of following error in homing	HOME.PERRTHRESH
3483h	0	INT32	1:1	RW	no	Sets the position error warning level	PL.ERRWTHRESH
3484h	0	INT32	1:1	RW	no	Specification of an additional movement after homing is completed.	HOME.DIST
3490h	0	INT32	1:1	RO	no	Position feedback offset	FB1.POFFSET
3491h	0	U32		RO	no	Location of index pulse on EEO	DRV.EMUEMTURN
3492h	0	U32		RO	no	Motion status of the drive	DRV.MOTIONSTAT
3493h	0	U8		RO	no	Direction of EEO (emulated encoder output)	DRV.EMUEDIR
3494h		RECORD				WS parameters	—
3494h	0	U8		RO	no	highest sub-index	—
3494h	1	INT16	1000:1	RW	no	Sets maximum current used for wake and shake	WS.IMAX
3494h	2	INT32	1:1	RW	no	Sets the maximum movement required for wake and shake	WS.DISTMAX
3494h	3	U16		RW	no	Sets the delay for wake and shake between loops in mode 0	WS.TDELAY30
3494h	4	INT32	1:1	RW	no	Defines the maximum allowed velocity for Wake & Shake	WS.VTHRESH
3494h	5	U8		RO	no	Reads wake and shake status	WS.STATE
3494h	6	U8		RW	no	Arm Wake and Shake to start	WS.ARM
3495h	0	U16	1000:1	RW	no	Voltage level for undervoltage warning.	VBUS.UVWTHRESH
3496h		ARRAY				FBUS synchronization parameters	—
3496h	0	U8		RO	no	highest sub-index	—
3496h	1	U32		RW	no	expected time distance between clearing the PLL counter and calling the PLL function	FBUS.SYNCDIST
3496h	2	U32		RW	no	actual time distance between clearing the PLL counter and calling the PLL function	FBUS.SYNCACT
3496h	3	U32		RW	no	Time window, which is used in order to consider the drive as being synchronized	FBUS.SYNCWND
3496h	4	U32		RW	no	Time, which is used for extending or lowering the sample rate of the internal 16 [kHz] IRQ	—
3498h	0	U8		RW	no	Protection level of fieldbus against other communication channels (Telnet, Modbus..)	FBUS.PROTECTION

Index	Sub-index	Data Type	Float Scale	Access	PDO map.	Description	ASCII object
3499h	0	INT32		RW	yes	Set-point for stepper motor output through the emulated encoder output (EEO)	DRV.EMUSTEPCMD
34A0h		ARRAY				PLS Position	
34A0h	0	U8		RO	no	highest sub-index	—
34A0h	1	INT32	1:1	RW	no	Limit switch 1 compare value	PLS.P1
34A0h	2	INT32	1:1	RW	no	Limit switch 2 compare value	PLS.P2
34A0h	3	INT32	1:1	RW	no	Limit switch 3 compare value	PLS.P3
34A0h	4	INT32	1:1	RW	no	Limit switch 4 compare value	PLS.P4
34A0h	5	INT32	1:1	RW	no	Limit switch 5 compare value	PLS.P5
34A0h	6	INT32	1:1	RW	no	Limit switch 6 compare value	PLS.P6
34A0h	7	INT32	1:1	RW	no	Limit switch 7 compare value	PLS.P7
34A0h	8	INT32	1:1	RW	no	Limit switch 8 compare value	PLS.P8
34A1h		ARRAY				PLS Width	—
34A1h	0	U8		RO	no	highest sub-index	—
34A1h	1	INT32	1:1	RW	no	Sets Limit Switch1 Width	PLS.WIDTH1
34A1h	2	INT32	1:1	RW	no	Sets Limit Switch 2 Width	PLS.WIDTH2
34A1h	3	INT32	1:1	RW	no	Sets Limit Switch 3 Width	PLS.WIDTH3
34A1h	4	INT32	1:1	RW	no	Sets Limit Switch 4 Width	PLS.WIDTH4
34A1h	5	INT32	1:1	RW	no	Sets Limit Switch 5 Width	PLS.WIDTH5
34A1h	6	INT32	1:1	RW	no	Sets Limit Switch 6 Width	PLS.WIDTH6
34A1h	7	INT32	1:1	RW	no	Sets Limit Switch 7 Width	PLS.WIDTH7
34A1h	8	INT32	1:1	RW	no	Sets Limit Switch 8 Width	PLS.WIDTH8
34A2h		ARRAY				PLS Time	—
34A2h	0	U8		RO	no	highest sub-index	—
34A2h	1	U16		RW	no	Sets limit switch 1 time	PLS.T1
34A2h	2	U16		RW	no	Sets limit switch 2 time	PLS.T2
34A2h	3	U16		RW	no	Sets limit switch 3 time	PLS.T3
34A2h	4	U16		RW	no	Sets limit switch 4 time	PLS.T4
34A2h	5	U16		RW	no	Sets limit switch 5 time	PLS.T5
34A2h	6	U16		RW	no	Sets limit switch 6 time	PLS.T6
34A2h	7	U16		RW	no	Sets limit switch 7 time	PLS.T7
34A2h	8	U16		RW	no	Sets limit switch 8 time	PLS.T8
34A3h		ARRAY				PLS Configuration	—
34A3h	0	U8		RO	no	highest sub-index	—
34A3h	1	U16		RW	no	Enables the limit switches	PLS.EN
34A3h	2	U16		RW	no	Resets limit switches	PLS.RESET
34A3h	3	U16		RW	no	Selects limit switch mode	PLS.MODE
34A3h	4	U16		RW	no	Reads the limit switch state	PLS.STATE
34A4h	0	U8		RW	no	Sets limit switch units	PLS.UNITS
34A8h	0	INT32		RW	no	Sets the Compare 0 modulo value	CMP0.MODVALUE
34A9h		ARRAY				Compare0 modulo bounds	—
34A9h	0	U8		RO	no	highest sub-index	—
34A9h	1	U8		RW	no	Compare0 modulo bound 1	CMP0.MODBOUND1
34A9h	2	U8		RW	no	Compare0 modulo bound 2	CMP0.MODBOUND2
34AAh		ARRAY				CMP0 setpoints	—
34AAh	0	U8		RO	no	highest sub-index	—
34AAh	1	INT32		RW	no	Compare0 setpoint 0	CMP0.SETPOINT 0

Index	Sub-index	Data Type	Float Scale	Access	PDO map.	Description	ASCII object
34AAh	2	INT32		RW	no	Compare0 setpoint 1	CMP0.SETPOINT 1
34AAh	3	INT32		RW	no	Compare0 setpoint 2	CMP0.SETPOINT 2
34AAh	4	INT32		RW	no	Compare0 setpoint 3	CMP0.SETPOINT 3
34AAh	5	INT32		RW	no	Compare0 setpoint 4	CMP0.SETPOINT 4
34AAh	6	INT32		RW	no	Compare0 setpoint 5	CMP0.SETPOINT 5
34AAh	7	INT32		RW	no	Compare0 setpoint 6	CMP0.SETPOINT 6
34AAh	8	INT32		RW	no	Compare0 setpoint 7	CMP0.SETPOINT 7
34ABh		ARRAY				CMP0 widths	—
34ABh	0	U8		RO	no	highest sub-index	—
34ABh	1	INT32		RW	no	Compare0 width 0	CMP0.WIDTH 0
34ABh	2	INT32		RW	no	Compare0 width 1	CMP0.WIDTH 1
34ABh	3	INT32		RW	no	Compare0 width 2	CMP0.WIDTH 2
34ABh	4	INT32		RW	no	Compare0 width 3	CMP0.WIDTH 3
34ABh	5	INT32		RW	no	Compare0 width 4	CMP0.WIDTH 4
34ABh	6	INT32		RW	no	Compare0 width 5	CMP0.WIDTH 5
34ABh	7	INT32		RW	no	Compare0 width 6	CMP0.WIDTH 6
34ABh	8	INT32		RW	no	Compare0 width 7	CMP0.WIDTH 7
34ACh		ARRAY				CMP0 widthtype	—
34ACh	0	U8		RO	no	highest sub-index	—
34ACh	1	U8		RW	no	Compare0 widthtype 0	CMP0.WIDTHTYPE 0
34ACh	2	U8		RW	no	Compare0 widthtype 1	CMP0.WIDTHTYPE 1
34ACh	3	U8		RW	no	Compare0 widthtype 2	CMP0.WIDTHTYPE 2
34ACh	4	U8		RW	no	Compare0 widthtype 3	CMP0.WIDTHTYPE 3
34ACh	5	U8		RW	no	Compare0 widthtype 4	CMP0.WIDTHTYPE 4
34ACh	6	U8		RW	no	Compare0 widthtype 5	CMP0.WIDTHTYPE 5
34ACh	7	U8		RW	no	Compare0 widthtype 6	CMP0.WIDTHTYPE 6
34ACh	8	U8		RW	no	Compare0 widthtype 7	CMP0.WIDTHTYPE 7
34ADh		ARRAY				CMP0 modes	—
34ADh	0	U8		RO	no	highest sub-index	—
34ADh	1	U8		RW	no	Compare0 mode 0	CMP0.MODE 0
34ADh	2	U8		RW	no	Compare0 mode 1	CMP0.MODE 1
34ADh	3	U8		RW	no	Compare0 mode 2	CMP0.MODE 2
34ADh	4	U8		RW	no	Compare0 mode 3	CMP0.MODE 3
34ADh	5	U8		RW	no	Compare0 mode 4	CMP0.MODE 4
34ADh	6	U8		RW	no	Compare0 mode 5	CMP0.MODE 5
34ADh	7	U8		RW	no	Compare0 mode 6	CMP0.MODE 6
34ADh	8	U8		RW	no	Compare0 mode 7	CMP0.MODE 7
34B0h		ARRAY				USER.DWORDS for writing of feedback memory	—
34B0h	0	U8		RO	no	highest sub-index	—
34B0h	1	U32		RW	no	FB1.USERDWORD1	FB1.USERDWORD1
34B0h	2	U32		RW	no	FB1.USERDWORD2	FB1.USERDWORD2
34B1h		ARRAY				USER.WORDS for writing of feedback memory	—
34B1h	0	U8		RO	no	highest sub-index	—
34B1h	1	U16		RW	no	FB1.USERWORD1	FB1.USERWORD1
34B1h	2	U16		RW	no	FB1.USERWORD2	FB1.USERWORD2
34B1h	3	U16		RW	no	FB1.USERWORD3	FB1.USERWORD3
34B1h	4	U16		RW	no	FB1.USERWORD4	FB1.USERWORD4

Index	Sub-index	Data Type	Float Scale	Access	PDO map.	Description	ASCII object
34B2h		ARRAY				USER.BYTES for writing of feedback memory	—
34B2h	0	U8		RO	no	highest sub-index	—
34B2h	1	U8		RW	no	FB1.USERBYTE1	FB1.USERBYTE1
34B2h	2	U8		RW	no	FB1.USERBYTE2	FB1.USERBYTE2
34B2h	3	U8		RW	no	FB1.USERBYTE3	FB1.USERBYTE3
34B2h	4	U8		RW	no	FB1.USERBYTE4	FB1.USERBYTE4
34B2h	5	U8		RW	no	FB1.USERBYTE5	FB1.USERBYTE5
34B2h	6	U8		RW	no	FB1.USERBYTE6	FB1.USERBYTE6
34B2h	7	U8		RW	no	FB1.USERBYTE7	FB1.USERBYTE7
34B2h	8	U8		RW	no	FB1.USERBYTE8	FB1.USERBYTE8
34B8h	0	INT32		RW	no	Sets the Compare 1 modulo value	CMP1.MODVALUE
34B9h		ARRAY				Compare1 modulo bounds	—
34B9h	0	U8		RO	no	highest sub-index	—
34B9h	1	U8		RW	no	Compare1 modulo bound 1	CMP1.MODBOUND1
34B9h	2	U8		RW	no	Compare1 modulo bound 2	CMP1.MODBOUND2
34BAh		ARRAY				CMP1 setpoints	—
34BAh	0	U8		RO	no	highest sub-index	—
34BAh	1	INT32		RW	no	Compare1 setpoint 0	CMP1.SETPOINT 0
34BAh	2	INT32		RW	no	Compare1 setpoint 1	CMP1.SETPOINT 1
34BAh	3	INT32		RW	no	Compare1 setpoint 2	CMP1.SETPOINT 2
34BAh	4	INT32		RW	no	Compare1 setpoint 3	CMP1.SETPOINT 3
34BAh	5	INT32		RW	no	Compare1 setpoint 4	CMP1.SETPOINT 4
34BAh	6	INT32		RW	no	Compare1 setpoint 5	CMP1.SETPOINT 5
34BAh	7	INT32		RW	no	Compare1 setpoint 6	CMP1.SETPOINT 6
34BAh	8	INT32		RW	no	Compare1 setpoint 7	CMP1.SETPOINT 7
34BBh		ARRAY				CMP1 widths	—
34BBh	0	U8		RO	no	highest sub-index	—
34BBh	1	INT32		RW	no	Compare1 width 0	CMP1.WIDTH 0
34BBh	2	INT32		RW	no	Compare1 width 1	CMP1.WIDTH 1
34BBh	3	INT32		RW	no	Compare1 width 2	CMP1.WIDTH 2
34BBh	4	INT32		RW	no	Compare1 width 3	CMP1.WIDTH 3
34BBh	5	INT32		RW	no	Compare1 width 4	CMP1.WIDTH 4
34BBh	6	INT32		RW	no	Compare1 width 5	CMP1.WIDTH 5
34BBh	7	INT32		RW	no	Compare1 width 6	CMP1.WIDTH 6
34BBh	8	INT32		RW	no	Compare1 width 7	CMP1.WIDTH 7
34BCh		ARRAY				CMP1 widthtype	—
34BCh	0	U8		RO	no	highest sub-index	—
34BCh	1	U8		RW	no	Compare1 widthtype 0	CMP1.WIDTHTYPE 0
34BCh	2	U8		RW	no	Compare1 widthtype 1	CMP1.WIDTHTYPE 1
34BCh	3	U8		RW	no	Compare1 widthtype 2	CMP1.WIDTHTYPE 2
34BCh	4	U8		RW	no	Compare1 widthtype 3	CMP1.WIDTHTYPE 3
34BCh	5	U8		RW	no	Compare1 widthtype 4	CMP1.WIDTHTYPE 4
34BCh	6	U8		RW	no	Compare1 widthtype 5	CMP1.WIDTHTYPE 5
34BCh	7	U8		RW	no	Compare1 widthtype 6	CMP1.WIDTHTYPE 6
34BCh	8	U8		RW	no	Compare1 widthtype 7	CMP1.WIDTHTYPE 7
34BDh		ARRAY				CMP1 modes	—
34BDh	0	U8		RO	no	highest sub-index	—
34BDh	1	U8		RW	no	Compare1 mode 0	CMP1.MODE 0

Index	Sub-index	Data Type	Float Scale	Access	PDO map.	Description	ASCII object
34BDh	2	U8		RW	no	Compare1 mode 1	CMP1.MODE 1
34BDh	3	U8		RW	no	Compare1 mode 2	CMP1.MODE 2
34BDh	4	U8		RW	no	Compare1 mode 3	CMP1.MODE 3
34BDh	5	U8		RW	no	Compare1 mode 4	CMP1.MODE 4
34BDh	6	U8		RW	no	Compare1 mode 5	CMP1.MODE 5
34BDh	7	U8		RW	no	Compare1 mode 6	CMP1.MODE 6
34BDh	8	U8		RW	no	Compare1 mode 7	CMP1.MODE 7
34C0h		ARRAY				Compare0 handling	—
34C0h	0	U8		RO	no	highest sub-index	—
34C0h	1	U16		RW	yes	Compare0 arm setpoints	CMP0.ARM 0..7
34C0h	2	U16		RW	yes	Compare0 states	CMP0.STATE 0..7
34C1h		ARRAY				Compare1 handling	—
34C1h	0	U8		RO	no	highest sub-index	—
34C1h	1	U16		RW	yes	Compare1 arm setpoints	CMP1.ARM 0..7
34C1h	2	U16		RW	yes	Compare1 states	CMP1.STATE 0..7
3501h	0	INT32	1:1	RW	no	Acceleration ramp	DRV.ACC, also see "6083h" (→ p. 972)
3502h	0	INT32	1:1	RW	no	Acceleration ramp for homing/jog modes	HOME.ACC
3506h	0	INT32			no	Action that hardware enable digital input will perform.	DRV.HWENMODE
3509h	0	INT32	1000:1	RO	no	Analog input voltage	AIN.VALUE
3522h	0	INT32	1:1	RW	no	Deceleration rate	DRV.DEC, also see "6084h" (→ p. 972)
3524h	0	INT32	1:1	RW	no	Deceleration ramp for homing/jog modes	HOME.DEC
352Ah	0	INT32		RW	no	Direction of movements	DRV.DIR
3533h	0	U32		RO	no	Resolution of motor encoder	FB1.ENCRES
3534h	0	U32		RO	no	Mode of EEO connector	DRV.EMUEMODE
3535h	0	U32		RO	no	Resolution of EEO	DRV.EMUERES
3537h	0	U32		RO	no	Location of EEO index pulse	DRV.EMUEZOFFSET
353Bh	0	INT32		RO	no	Selection of the feedback type	FB1.SELECT
3542h	0	U32	1000:1	RW	no	Position Control Loop: Proportional Gain	PL.KP
3548h	0	U32	1000:1	RW	no	Velocity Control Loop: Proportional Gain	VL.KP
354Bh	0	INT32	1000:1	RW	no	Sets the velocity loop velocity feedforward gain value	VL.KVFF
354Dh	0	INT32	1000:1	RW	no	Velocity Control Loop: I-Integration Time	VL.KI
3558h	0	INT32	1000:1	RO	no	Current Monitor	IL.FB
3559h	0	INT32	1000:1	RO	no	Drive Ifold	IL.DIFOLD
355Ah	0	INT32	1000:1	RW	no	I2T Warning	IL.FOLDWTHRESH
3562h	0	INT32		RW	no	Function of Digital Input 1	DIN1.MODE
3565h	0	INT32		RW	no	Function of Digital Input 2	DIN2.MODE
3568h	0	INT32		RW	no	Function of Digital Input 3	DIN3.MODE
356Bh	0	INT32		RW	no	Function of Digital Input 4	DIN4.MODE
356Eh	0	INT32	1000:1	RW	no	Application Peak Current, positive direction	IL.LIMITP

Index	Sub-index	Data Type	Float Scale	Access	PDO map.	Description	ASCII object
356Fh	0	INT32	1000:1	RW	no	Application Peak Current, negative direction	IL.LIMITN
3586h	0	U32		RW	no	Sets the motor temperature fault level	MOTOR.TEMPFAULT
3587h	0	INT32		RW	no	Select Motor Holding Brake	MOTOR.BRAKE
358Eh	0	U32	1000:1	RW	no	Motor Continuous Current Rating	MOTOR.ICONT
358Fh	0	U32	1000:1	RW	no	Motor Peak Current Rating	MOTOR.IPEAK
3593h	0	U32	1000:1	RW	no	Sets the torque constant of the motor	MOTOR.KT
3596h	0	U32	1000:1	RO	no	Sets the proportional gain of the d-component current PI-regulator as a percentage of IL.KP	IL.KPDRATIO
3598h	0	INT32	1000:1	RW	no	Absolute Gain of Current Control loop	IL.KP
359Ch	0	U32		RW	no	Sets the motor phase.	MOTOR.PHASE
359Dh	0	U32		RW	no	Sets the number of motor poles	MOTOR.POLES
35A3h	0	U32		RW	no	Sets the maximum motor speed	MOTOR.VMAX
35A4h	0	INT32	1000:1	RW	no	Maximum motor current	IL.MIFOLD
35ABh	0	U32	1000:1	RW	no	Sets the motor inertia	MOTOR.INERTIA
35AFh	0	U32		RW	no	Sets the digital output 1 mode	DOOUT1.MODE
35B2h	0	U32		RW	no	Sets the digital output 2 mode	DOOUT2.MODE
35B4h	0	INT32		RW	no	Operating Mode	DRV.OPMODE
35B9h	0	INT32		RW	no	Control for Motion Task 0	MT.CNTL
35BCh	0	INT32		RW	no	Next Task Number for Motion Task 0	MT.MTNEXT
35C2h	0	INT32		RW	no	Select regen resistor	REGEN.REXT
35C5h	0	INT32	1:1	RO	no	Actual Following Error	PL.ERR
35C6h	0	INT32	1:1	RW	no	In-Position Window	MT.TPOSWND
35C7h	0	INT32	1:1	RW	no	Max. Following Error	PL.ERRFTHRESH
35CAh	0	INT32		RW	no	Position Resolution (Numerator)	UNIT.PIN
35CBh	0	INT32		RW	no	Position Resolution (Denominator)	UNIT.POUT
35CFh	0	INT32		RW	no	reserved	PL.MODPEN
35D2h	0	U32		RO	no	Mechanical Position	FB1.MECHPOS
35E2h	0	U32	1:1	RW	no	Sets the current limit during homing procedure to a mechanical stop	HOME.IPEAK
35EBh	0	INT32		WO	no	Save Data in EEPROM	DRV.NVSAVE
35F0h	0	INT32		WO	no	Set Reference Point	HOME.SET
35FEh	0	INT32		WO	no	Stop Motion Task	DRV.STOP
35FFh	0	U32		RW	no	Selects between disable immediately or stop and then disable	DRV.DISMODE
3610h	0	INT32		RO	no	Ambient Temperature	DRV.TEMPERATURES
3611h	0	INT32		RO	no	Heat Sink Temperature	DRV.TEMPERATURES
3612h	0	INT32		RO	no	Motor Temperature	MOTOR.TEMP

Index	Sub-index	Data Type	Float Scale	Access	PDO map.	Description	ASCII object
3617h	0	U32	1:1	RW	no	Undervoltage mode	VBUS.UVMODE
3618h	0	INT32	1:1	RO	no	Actual Velocity	VL.FB
361Ah	0	INT32		RO	no	DC-bus voltage	VBUS.VALUE
361Dh	0	U32	1000:1	RW	no	Voltage level for undervoltage fault	VBUS.UVFTHRESH
3622h	0	INT32	1:1	RW	no	Max. Velocity	VL.LIMITP
3623h	0	INT32	1:1	RW	no	Max. Negative Velocity	VL.LIMITN
3627h	0	INT32	1:1	RW	no	Overspeed	VL.THRESH
3629h	0	INT32	1000:1	RW	no	SW1 Velocity Scaling Factor	AIN.VSCALE
3637h	0	INT32	1:1	RW	no	reserved	PL.MODP1
3638h	0	INT32	1:1	RW	no	reserved	PL.MODP2
3656h	0	U64	1:1	RW	no	Initial feedback position	FB1.ORIGIN
3659h	0	INT32		RW	no	Type of acceleration setpoint for the system	UNIT.ACCROTARY
365Bh	0	INT32		RW	no	Presetting for motion task that is processed later	MT.NUM
365Fh	0	INT32		RW	no	Systemwide Definition of Velocity/Speed	UNIT.VROTARY
3660h	0	INT32		RW	no	Set Resolution of the Position	UNIT.PROTARY
366Eh	0	INT32		RW	no	Disable Delaytime with Holding Brake	MOTOR.TBRAKEAPP
366Fh	0	INT32		RW	no	Enable Delaytime with Holding Brake	MOTOR.TBRAKERLS
3683h	0	U16		RW	no	Delay for wake and shake timing	WS.TDELAY1
3685h	0	U16		RW	no	Sets delay for wake and shake timing	WS.TDELAY2
36D0h	0	U16		RW	no	Sets wake and shake current-vector appliance time	WS.T
36D1h	0	U32	1:1	RW	no	Sets the minimum movement required for wake and shake	WS.DISTMIN
36D7h	0	U32	1000:1	RW	no	Sets homing auto move flag	HOME.AUTOMOVE
36E2h	0	U8		RW	no	Sets the number of repetitions for wake and shake	WS.NUMLOOPS
36E5h	0	U32		RW	no	CAN baud rate selection	FBUS.PARAM01
36E6h	0	U32		RW	no	pll synchronization	FBUS.PARAM02
36E7h	0	U32		RW	no	-	FBUS.PARAM03
36E8h	0	U32		RW	no	SYNC surveillance	FBUS.PARAM04
36E9h	0	U32		RW	no	-	FBUS.PARAM05
36EAh	0	U32		RW	no	-	FBUS.PARAM06
36EBh	0	U32		RW	no	-	FBUS.PARAM07
36ECh	0	U32		RW	no	-	FBUS.PARAM08
36EDh	0	U32		RW	no	-	FBUS.PARAM09
36EEh	0	U32		RW	no	-	FBUS.PARAM10
36F6h	0	INT32		RW	no	Function of Digital Input 5	DIN5.MODE
36F9h	0	INT32		RW	no	Function of Digital Input 6	DIN6.MODE
36FCh	0	U32		RW	no	Function of Digital Input 7	DIN7.MODE
3856h	0	INT32	1:1	RW	no	velocity window for profile position mode	MT.TVELWND

Objects 5000h to 5999h

Index	Sub-index	Data Type	Float Scale	Access	PDO map.	Description	ASCII object
5000h	0	UINT32		RW	no	Analog input low-pass filter cutoff frequency.	AIN.CUTOFF
5001h	0	UINT32		RW	no	Analog input signal dead-band.	AIN.DEADBAND
5002h	0	UINT32		RW	no	Analog current scale factor.	AIN.ISCALE
5003h	0	UINT32		RW	no	Analog input offset.	AIN.OFFSET
5009h	0	UINT32		RW	no	Analog current scale factor.	AOUT.ISCALE
500Bh	0	UINT32		RW	no	Analog output offset.	AOUT.OFFSET
5013h	0	UINT32		RW	no	Controls how often the excitation is updated.	BODE.EXCITEGAP
5015h	0	UINT32		RW	no	Current command value used during the Bode procedure.	BODE.IAMP
5016h	0	UINT32		RW	no	Sets whether the excitation uses current or velocity excitation type.	BODE.INJECTPOINT
5019h	0	UINT32		RW	no	Length of the PRB signal before it repeats.	BODE.PRBDEPTH
5060h	0	UINT32		RW	no	Sets the fault relay mode.	DOUT.RELAYMODE
5080h	0	UINT32		RW	no	Default state of the software enable.	DRV.ENDEFAULT
5083h	0	UINT32		RW	no	Continuous rated current value.	DRV.ICONT
5084h	0	UINT32		RW	no	Peak rated current value.	DRV.IPEAK
5085h	0	UINT32		RW	no	Current that will be used during the DRV.ZERO procedure.	DRV.IZERO
508Ch	0	UINT32		RW	no	Number of Biss Sensor (Position) Bits for the BiSS Mode C encoder in use.	FB1.BISSBITS
508Fh	0	UINT32		RW	no	Initial feedback value as signed or unsigned.	FB1.INITSIGNED
5096h	0	UINT32		RW	no	Current value used during the phase finding procedure (PFB.PFIND=1)	FB1.PFINDCMDU
5097h	0	UINT32		RW	no	Number of feedback poles.	FB1.POLES
5099h	0	UINT32		RW	no	Resolver nominal transformation ratio.	FB1.RESKTR
509Ah	0	UINT32		RW	no	Electrical degrees of phase lag in the resolver.	FB1.RESREFPHASE
509Ch	0	UINT32		RW	no	Controls tracking calibration algorithm.	FB1.TRACKINGCAL
50B1h	0	UINT32		RW	no	Number of successful synchronized cycles needed to lock the PLL.	FBUS.PLLTHRESH
50BBh	0	UINT32		RW	no	Denominator of the electronic gearing ratio; active in opmode 2 (position) only.	GEAR.IN

Index	Sub-index	Data Type	Float Scale	Access	PDO map.	Description	ASCII object
50BCh	0	UINT32		RW	no	Electronic gearing mode; active in opmode 2 (position) only.	GEAR.MODE
50BEh	0	UINT32		RW	no	Numerator of the electronic gearing ratio; active in opmode 2 (position) only.	GEAR.OUT
50C5h	0	UINT32		RW	no	Homing direction	HOME.DIR
50CBh	0	UINT32		RW	no	Homing mode	HOME.MODE
50E2h	0	UINT32		RW	no	Current loops fieldbus injected feed-forward gain	IL.KBUSFF
50FBh	0	UINT32		RW	no	Motor pitch.	MOTOR.PITCH
50FEh	0	UINT32		RW	no	Type of thermal resistor inside the motor.	MOTOR.RTYPE
5104h	0	UINT32		RW	no	Motor type.	MOTOR.TYPE
510Eh	0	UINT32		RW	no	Motion task to be triggered after an emergency stop procedure; active in opmode 2 (position) only.	MT.EMERGMT
5121h	0	UINT32		RW	no	Type of following error warning and fault usage.	PL.ERRMODE
5128h	0	UINT32		RW	no	Feedback source for the position loop.	PL.FBSOURCE
5175h	0	UINT32		RW	no	Service motion current 1; active in opmode 0 (torque) only.	SM.I1
5176h	0	UINT32		RW	no	Service motion current 2; active in opmode 0 (torque) only.	SM.I2
5177h	0	UINT32		RW	no	Service motion mode.	SM.MODE
5179h	0	UINT32		RW	no	Service motion time 1.	SM.T1
517Ah	0	UINT32		RW	no	Service motion time 2.	SM.T2
517Eh	0	UINT32		RW	no	Enables and disables software travel limit switches.	SWLS.EN
5184h	0	UINT32		RW	no	Linear acceleration/deceleration units.	UNIT.ACCLINEAR
5187h	0	UINT32		RW	no	Linear position units.	UNIT.PLINEAR
518Ah	0	UINT32		RW	no	Linear velocity units.	UNIT.VLINEAR
518Eh	0	UINT32		RW	no	Voltage level for over voltage warning.	VBUS.OVWTHRESH
51AEh	0	UINT32		RW	no	Feedback source for the velocity loop; active in opmodes 1 (velocity) and 2 (position) only.	VL.FBSOURCE
51B0h	0	UINT32		RW	no	Mode of velocity generation (Observer, d/dt); active in opmodes 1 (velocity) and 2 (position) only.	VL.GENMODE
51B3h	0	UINT32		RW	no	Scales the observer velocity signal; active in opmodes 1 (velocity) and 2 (position) only.	VL.KO

Index	Sub-index	Data Type	Float Scale	Access	PDO map.	Description	ASCII object
51B8h	0	UINT32		RW	no	Ratio of the estimated load moment of inertia relative to the motor moment of inertia; active in opmodes 1 and 2 only.	VL.LMJR
51BAh	0	UINT32		RW	no	Bandwidth of the observer in Hz.	VL.OBSBW
51BBh	0	UINT32		RW	no	Observer operating mode.	VL.OBSMODE
51CBh	0	UINT32		RW	no	Filter mode for Digital In 1.	DIN1.FILTER
51CCh	0	UINT32		RW	no	Filter mode for Digital In 2.	DIN2.FILTER
51CDh	0	UINT32		RW	no	Filter mode for Digital In 3.	DIN3.FILTER
51CEh	0	UINT32		RW	no	Filter mode for Digital In 4.	DIN4.FILTER
51CFh	0	UINT32		RW	no	Filter mode for Digital In 5.	DIN5.FILTER
51D0h	0	UINT32		RW	no	Filter mode for Digital In 6.	DIN6.FILTER
51D1h	0	UINT32		RW	no	Filter mode for Digital In 7.	DIN7.FILTER
51E7h	0	UINT32		RW	no	Modbus User Units Input parameter	MODBUS.PIN
51E8h	0	UINT32		RW	no	Modbus User Units Output parameter.	MODBUS.POUT
51E9h	0	UINT32		RW	no	Feedback Resolution (per rev) over Modbus.	MODBUS.PSCALE
51ECh	0	UINT32		RW	no	Secondary feedback (FB2) resolution.	FB2.ENCRECRES
51EDh	0	UINT32		RW	no	Mode for the second feedback inputs and high speed digital inputs.	FB2.MODE
51EEh	0	UINT32		RW	no	Source for the second feedback input.	FB2.SOURCE
51EFh	0	UINT32		RW	no	Brake apply timeout for vertical axis.	MOTOR.TBRAKETO
51F0h	0	UINT32		RW	no	i.p.	MODBUS.MSGLOG
520Ch	0	UINT32		RW	no	Scaling mode for Modbus values.	MODBUS.SCALING
520Dh	0	UINT32		RW	no	Encoder output pulse width for modes 6 to 7.	DRV.EMUEPULSE-WIDTH
520Eh	0	UINT32		RW	no	Enable/disable motor velocity vs. maximum emulated encoder velocity monitoring function.	DRV.EMUECHECK-SPEED
5251h	0	UINT32		RW	no	Analog input deadband mode.	AIN.DEADBANDMODE
5252h	0	UINT32		RW	no	Analog input mode	AIN.MODE
5253h	0	UINT32		RW	no	Direction of IOs from X9.	DIO10.DIR
5254h	0	UINT32		RW	no	Inverting the output voltage of the IO, when in the output direction.	DIO10.INV
5255h	0	UINT32		RW	no	Direction of IOs from X9.	DIO11.DIR
5256h	0	UINT32		RW	no	Inverting the output voltage of the IO, when in the output direction.	DIO11.INV
5257h	0	UINT32		RW	no	Direction of IOs from X9.	DIO9.DIR

Index	Sub-index	Data Type	Float Scale	Access	PDO map.	Description	ASCII object
5258h	0	UINT32		RW	no	Inverting the output voltage of the IO, when in the output direction.	DIO9.INV
5259h	0	UINT32		RW	no	Fault Action for Fault 130.	FAULT130.ACTION
525Ah	0	UINT32		RW	no	Fault Action for Fault 131.	FAULT131.ACTION
525Bh	0	UINT32		RW	no	Fault Action for Fault 132.	FAULT132.ACTION
525Ch	0	UINT32		RW	no	Fault Action for Fault 133.	FAULT134.ACTION
525Dh	0	UINT32		RW	no	Fault Action for Fault 702.	FAULT702.ACTION
525Eh	0	UINT32		RW	no	Method of acquiring IP Address.	IP.MODE
525Fh	0	UINT32		RW	no	Load inertia.	LOAD.INERTIA
5260h	0	UINT32		RW	no	Motor back EMF constant.	MOTOR.KE
5261h	0	UINT32		RW	no	Changing voltage thresholds.	VBUS.HALFVOLT
5262h	0	UINT32		RW	no	Direction for the second feedback input (X9 and X7).	FB2.DIR
5263h	0	UINT32		RW	no	Feedback for handwheel operation.	DRV.HANDWHEELSRC
5264h	0	UINT32		RW	no	Delay time between inactive Hardware Enable input and drive disable.	DRV.HWENDELAY
5265h	0	UINT32		RW	no	Index into the Current Loop Gain Scheduling Table.	IL.KPLOOKUPINDEX
5266h	0	UINT32		RW	no	Value of the current loop gain scheduling index.	IL.KPLOOKUPVALUE
5267h	0	UINT32		RW	no	Fault Action for Fault 451.	FAULT451.ACTION
5268h	0	UINT32		RW	no	Brake Immediately in the case of a drive disable.	MOTOR.BRAKEIMM
5352h	0	UINT16		RW	no	Amount of time a communication error must be present before an W&S-fault is thrown.	WS.CHECKT
535Ch	0	UINT16		RW	no	Sets the calming time of the motor for Wake & Shake mode 1.	WS.TSTANDSTILL
535Dh	0	UINT16		RW	no	Time for the ramp up current in Wake & Shake mode 1.	WS.TIRAMP
5360h	0	UINT16		RW	no	Rotor time constant.	MOTOR.IMTR
5361h	0	UINT8		RW	no	Sets the feedback source for the current loop for MOTOR.TYPE4.	IL.FBSOURCE
5362h	0	UINT32		RW	no	The direct-axis current set point used for induction machine closed-loop control.	MOTOR.IMID
538Bh	0	UINT16		RW	no	tbd	DRV.EMUESTEPMODE
538Ch	0	UINT16		RW	no	tbd	DRV.EMUESTEPSTATUS
538Dh	0	UINT16		RW	no	tbd	DRV.EMUESTEPVMAX
538Fh	0	INT8		RW	no	Compare engine 0 source	CMP0.SOURCE
5390h	0	INT8		RW	no	Compare engine 1 source	CMP1.SOURCE
5394h	0	U16		RW	no	Compare engine 0 output mask	CMP0.OUTMASK

Index	Sub-index	Data Type	Float Scale	Access	PDO map.	Description	ASCII object
539Bh	0	U16		RW	no	Compare engine 1 output mask	CMP1.OUTMASK
53A6h	0	U8		RW	no	Compare engine 0 modulo enable	CMP0.MODEN
53ADh	0	U8		RW	no	Compare engine 1 modulo enable	CMP1.MODEN
53B1h	0	U32		RW	no	Compare engine 0 advance	CMP0.ADVANCE
53B2h	0	U32		RW	no	Compare engine 1 advance	CMP1.ADVANCE

21.2.5 Profile specific SDOs

Index	Sub-index	Data Type	Float Scale	Access	PDO map.	Description	ASCII object
6040h	0	U16		WO	yes	Control word	—
6041h	0	U16		RO	yes	Status word	—
6060h	0	INT8		RW	yes	Modes of Operation	—
6061h	0	INT8		RO	yes	Modes of Operation Display	—
6063h	0	INT32		RO	yes	Position actual value (increments)	—
6064h	0	INT32	1:1	RO	yes	Position actual value (position units)	PL.FB
6065h	0	U32	1:1	RW	no	Following error window	PL.ERRFTHRESH
606Bh	0	INT32	1:1	RO	no	Velocity demand value	VL.CMD
606Ch	0	INT32	1000:1	RO	yes	Velocity actual value (PDO in RPM)	VL.FB
606Dh	0	U16		RW	yes	Velocity window	
606Eh	0	U16		RW	yes	Velocity window time	
6071h	0	INT16		RW	yes*	Target torque	—
6072h	0	U16		RW	yes*	Max torque	—
6073h	0	U16		RW	no	Max current	
6077h	0	INT16		RO	yes	Torque actual value	—
607Ah	0	INT32	1:1	RW	yes	Target position	MT.P
607Ch	0	INT32	1:1	RW	no	Reference offset	HOME.P
607Dh		ARRAY				Software position limit	
607Dh	0	U8		RO	no	highest sub-index	
607Dh	1	INT32	1:1	RW	no	Software position limit 1	SWLS.LIMIT0
607Dh	2	INT32	1:1	RW	no	Software position limit 2	SWLS.LIMIT1
6081h	0	U32	1:1	RW	yes	Profile Velocity	MT.V
6083h	0	U32	1:1	RW	yes	Profile Acceleration	MT.ACC , DRV.ACC
6084h	0	U32	1:1	RW	yes	Profile Deceleration	MT.DEC , DRV.DEC
608Fh		ARRAY				Position encoder resolution	—
608Fh	0	U8		RO	no	highest sub-index	—
608Fh	1	U32		RW	no	Encoder increments	—
608Fh	2	U32		RW	no	Motor revolutions	
6091h		ARRAY				Gear ratio	—
6091h	0	U8		RO	no	highest sub-index	—
6091h	1	U32		RW	no	Motor revolution	
6091h	2	U32		RW	no	Shaft revolutions	

Index	Sub-index	Data Type	Float Scale	Access	PDO map.	Description	ASCII object
6092h		ARRAY				Feed constant	—
6092h	0	U8		RO	no	highest sub-index	—
6092h	1	U32		RW	no	Feed	UNIT.PIN
6092h	2	U32		RW	no	Shaft revolutions	—
6098h	0	INT8		RW	no	Homing type	HOME.MODE , HOME.DIR
6099h		ARRAY				Homing velocity	—
6099h	0	U8		RO	no	highest sub-index	—
6099h	1	U32	1:1	RW	no	Speed while searching for limit switch	HOME.V
6099h	2	U32		RW	no	Speed while searching for zero mark	HOME.FEEDRATE
609Ah	0	U32	1:1	RW	no	Homing acceleration	HOME.ACC , HOME.DEC
60B1h	0	INT32	1:1	RW	yes*	Velocity offset	VL.BUSFF
60B2h	0	INT16		RW	yes*	Torque offset (PDO only)	—
60B8h	0	U16		RW	yes	Touch probe function	—
60B9h	0	U16		RW	yes	Touch probe status	—
60BAh	0	INT32		RW	yes	Touch probe 1 positive edge	—
60BBh	0	INT32		RW	yes	Touch probe 1 negative edge	—
60BCh	0	INT32		RW	yes	Touch probe 2 positive edge	—
60BDh	0	INT32		RW	yes	Touch probe 2 negative edge	—
60C0h	0	INT16		RW	no	Interpolation submode select	—
60C1h		ARRAY				Interpolation data record	—
60C1h	0	U8		RO	no	highest sub-index	—
60C1h	1	INT32		RW	yes*	Interpolation target position	—
60C1h	2	U32		RW	yes	Interpolation time	—
60C1h	3	INT32		RW	yes	Interpolation target velocity	—
60C2h		RECORD				Interpolation time period	—
60C2h	0	U8		RO	no	highest sub-index	FBUS.SAMPLEPERIOD
60C2h	1	U8		RW	no	Interpolation time units	—
60C2h	2	INT8		RW	no	Interpolation time index	—
60C4h		RECORD				Interpolation data configuration	—
60C4h	0	U8		RO	no	highest sub-index	—
60C4h	1	U32		RO	no	Maximum buffer size	—
60C4h	2	U32		RO	yes	Actual buffer size	—
60C4h	3	U8		RW	no	Buffer organization	—
60C4h	4	U16		RW	no	Buffer position	—
60C4h	5	U8		WO	no	Size of data record	—
60C4h	6	U8		WO	no	Buffer clear	—
60D0h		ARRAY				Touch probe source	—
60D0h	0	U8		RO	no	highest sub-index	-
60D0h	1	INT16		RW	no	Touch probe 1 source	—
60D0h	2	INT16		RW	no	Touch probe 2 source	—
60E0h	0	UINT16		RO	yes*	Positive torque limit value	IL.LIMITP
60E1h	0	UINT16		RO	yes*	Negative torque limit value	IL.LIMITN
60E4h		ARRAY				Additional position actual value	—

Index	Sub-index	Data Type	Float Scale	Access	PDO map.	Description	ASCII object
60E4h	0	U8		RO	no	highest sub-index	—
60E4h	1	INT32		RW	no	1st additional position actual value	—
60E4h	2	INT32		RW	no	reserved	—
60E4h	3	INT32		RW	no	3rd additional position actual value	—
60E8h		ARRAY				Additional gear ratio - motor shaft revolutions	—
60E8h	0	U8		RO	no	highest sub-index	—
60E8h	1	U32		RW	no	1st additional gear ratio - motor shaft revolutions	—
60E8h	2	U32		RW	no	reserved	—
60E8h	3	U32		RW	no	3rd additional gear ratio - motor shaft revolutions	—
60E9h		ARRAY				Additional feed constant - feed	—
60E9h	0	U8		RO	no	highest sub-index	—
60E9h	1	U32		RW	no	1st additional feed constant - feed	—
60E9h	2	U32		RW	no	reserved	—
60E9h	3	U32		RW	no	3rd additional feed constant - feed	—
60EDh		ARRAY				Additional gear ratio - driving shaft revolutions	—
60EDh	0	U8		RO	no	highest sub-index	—
60EDh	1	U32		RW	no	1st additional gear ratio - driving shaft revolutions	—
60EDh	2	U32		RW	no	reserved	—
60EDh	3	U32		RW	no	3rd additional gear ratio - driving shaft revolutions	—
60EEh		ARRAY				Additional feed constant - driving shaft revolutions	—
60EEh	0	U8		RO	no	highest sub-index	—
60EEh	1	U32		RW	no	1st additional feed constant - driving shaft revolutions	—
60EEh	2	U32		RW	no	reserved	—
60EEh	3	U32		RW	no	3rd additional feed constant - driving shaft revolutions	—
60F4h	0	INT32		RO	yes	Following error actual value	PL.ERR
60FCh	0	INT32		RO	yes	Position demand internal value	PL.CMD
60FDh	0	U32		RO	yes	Digital inputs	DIN1.MODE TO DIN6.MODE DIN1.MODE TO DIN3.MODE
60FEh		ARRAY				Digital outputs	
60FEh	0	U8		RO	no	highest sub-index	
60FEh	1	U32		RW	yes	Physical outputs	
60FEh	2	U32		RW	no	Bit mask	
60FFh	0	INT32	1000:1	RW	yes*	Target velocity	VL.CMDU
6502h	0	U32		RO	no	Supported drive modes	—

21.3 Object descriptions

The objects in this section are sorted by object number.

21.3.1 Object 1000h: Device Type (DS301)

This object describes the device type (servo drive) and device functionality (DS402 drive profile). Definition:

MSB		LSB	
Additional information		Device profile number	
Mode bits	Type	402d=192h	
31	24	23	16 15 0

The device profile number is DS402, the type is 2 for drives, the mode bits 28 to 31 are manufacturer specific and may be changed from its actual value of 0. A read access delivers 0x00020192 at the moment.

Index	1000h
Name	device type
Object code	VAR
Data type	UNSIGNED32
Category	mandatory
Access	R/O
PDO mapping	not possible
Value range	UNSIGNED32
Default value	no

21.3.2 Object 1001h: Error register (DS301)

This object is an error register for the device. The device can map internal errors into this byte. It is a part of an Emergency object.

Index	1001h
Name	Error register
Object code	VAR
Data type	UNSIGNED8
Category	mandatory
Access	R/O
PDO mapping	not possible
Value range	UNSIGNED8
Default value	no

Error reasons to be signaled: If a bit is set to 1 the specified error has occurred. The generic error is signaled at any error situation.

Bit	Description	Bit	Description
0	generic error	4	communication error (overrun, error state)
1	current	5	device profile specific
2	voltage	6	reserved (always 0)
3	temperature	7	manufacturer specific

21.3.3 Object 1002h: Manufacturer Status Register (DS301)

The manufacturer status register contains important drive informations.

Index	1002h
Name	Manufacturer Status Register
Object code	VAR
Data type	UNSIGNED32
Category	optional
Access	R/O
PDO mapping	possible
Value range	UNSIGNED32
Default value	no

The following table shows the bit assignment for the status register:

Bit	Description	Bit	Description
0	1 = Movement (positioning, homing) active	16	1 = Homing move active
1	reference position set	17	reserved
2	1 = reference switch high (home-position)	18	reserved
3	1 = In Position	19	1 = Emergency stop active
4	reserved	20	reserved
5	reserved	21	reserved
6	reserved	22	reserved
7	Active Disabel activated	23	1 = Homing move finished
8	Warning active	24	Power stage deactivating
9	1 = target velocity reached (pp- or pv-Mode)	25	1 = digital input 1 set
10	reserved	26	1 = digital input 2 set
11	1 = Homing error	27	1 = digital input 3 set
12	reserved	28	1 = digital input 4 set
13	1 = Safe Torque Off selected	29	1 = digital input hardware enable set
14	1 = Power stage enabled		
15	1 = Error state	31	Braking, 1 = set points not accepted

21.3.4 Object 1003h: Predefined Error Field (DS301)

The object 1003h provides an error history with a maximum size of 10 entries.

Subindex 0 contains the number of errors which have occurred since the last reset of the error history, either by startup of the drive or resetting the error history by writing 0 to subindex 0.

A new Emergency-message is written into subindex 1 shifting the old entries one subindex higher. The old content of subindex 8 is lost.

The UNSIGNED32-information written to the subindexes is defined in the field Error Code in the description of the Emergency Messages (→ p. 945).

Index	1003h
Name	pre-defined Error Field
Object code	ARRAY
Data type	UNSIGNED32
Category	optional
Subindex	0
Description	highest sub-index supported
Data type	UNSIGNED8
Category	mandatory
Access	R/W
PDO mapping	not possible
Value range	0 to 10
Default value	0
Subindex	1 to 10
Description	Standard error field (→ p. 945)
Category	optional
Access	R/O
PDO mapping	not possible
Value range	UNSIGNED32
Default value	no

21.3.5 Object 1005h: COB-ID of the SYNC Message (DS301)

This object defines the COB-Id of the synchronisation object (SYNC).

Index	1005h
Name	COB-ID for the SYNC message
Object code	VAR
Data type	UNSIGNED32
Category	conditional
Access	R/W
PDO mapping	not possible
Value range	UNSIGNED32
Default value	0x80

Bit coded information:

Bit	Value	Meaning
31 (MSB)	X	—
30	0	Device not generate SYNC message
	1	Device generates SYNC message
29	0	11 Bit ID (CAN 2.0A)
	1	29 Bit ID (CAN 2.0B)
28 to 11	X	—
	0	if Bit 29=0
10 to 0 (LSB)	X	Bit 0 to 10 of SYNC COB-ID

The device does not support the generation of SYNC-messages and only the 11-bit IDs. So the bits 11 to 30 are always 0.

21.3.6 Object 1006h: Communication Cycle Period (DS301)

This object can be used to define the period (in μ s) for the transmission of the SYNC telegram.

Index	1006h
Name	Period of the communication cycle
Object code	VAR
Data type	UNSIGNED32
Category	O
Access	R/W
PDO mapping	not possible
Value range	UNSIGNED32
Default value	00h

21.3.7 Object 1008h: Manufacturer Device Name (DS301)

The device name consists of four ASCII characters in the form Yzzz, whereby Y stands for the mains voltage (L, M, H or U, e.g. H for High Voltage) zzz stands for the power stage current.

Index	1008h
Name	Manufacturer Device Name
Object code	VAR
Data type	Visible String
Category	Optional
Access	const
PDO mapping	not possible
Value range	
Default value	no

21.3.8 Object 1009h: Manufacturer Hardware Version

This object will be supported in the future.

Index	1009h
Name	manufacturer hardware version
Object code	VAR
Data type	Visible String
Category	Optional
Access	const
PDO mapping	not possible
Value range	-
Default value	no

21.3.9 Object 100Ah: Manufacturer Software Version (DS301)

The object contains the manufacturer software version (here: the CANopen-part of the drive firmware).

Index	100Ah
Name	Manufacturer Software Version
Object code	VAR
Data type	Visible String
Category	Optional
Access	const
PDO mapping	not possible
Value range	0.01 to 9.99
Default value	no

21.3.10 Object 100Ch: Guard Time (DS301)Response monitoring

The arithmetical product of the Objects 100Ch Guard Time and 100Dh Lifetime Factor is the response monitoring time. The Guard Time is given in milliseconds. The response monitoring is activated with the first Nodeguard object. If the value of the object Guard Time is set to zero, then the response monitoring is inactive.

Index	100Ch
Name	Guard Time
Object code	VAR
Data type	UNSIGNED16
Category	conditional; mandatory, if heartbeat not supported
Access	R/W
PDO mapping	not possible
Value range	UNSIGNED16
Default value	0

21.3.11 Object 100Dh: Lifetime Factor (DS301)

The product of Guard Time and Life Time Factor gives the life time for the nodeguarding protocol. If it's 0, the protocol is not used.

Index	100Dh
Name	Lifetime Factor
Object code	VAR
Data type	UNSIGNED8
Category	conditional; (mandatory, if heartbeat not supported)
Access	R/W
PDO mapping	not possible
Value range	UNSIGNED8
Default value	0

21.3.12 Object 1010h: Store Parameters (DS301)

This object supports the saving of parameters to a flash EEPROM. Only the subindex 1 for saving of all parameters, which can also be saved in the parameter files via the GUI, is supported.

Index	1010h
Name	store parameters (DRV.NVSAVE)
Object code	ARRAY
Data type	UNSIGNED32
Category	optional
Subindex	0
Name	highest sub-index supported
Object code	VAR
Data type	UNSIGNED8
Category	mandatory
Access	R/O
PDO Mapping	not possible
Value range	1
Default value	1
Subindex	1
Name	save all parameters
Object code	VAR
Data type	UNSIGNED32
Category	mandatory
Access	R/W
PDO Mapping	not possible
Value range	UNSIGNED32
Default value	1

Data definition:

Bit	Value	Meaning
31 to 2	0	reserved (=0)
1	0	Device does not save parameters autonomously
	1	Device does save parameters autonomously
0	0	Device does not save parameters on command
	1	Device does save parameters on command

By read access to subindex 1 the drive provides information about its storage functionality.

This drive provides a constant value of 1 by read access, i.e. all parameters can be saved by writing to Object 1010 sub 1. In general the drive does not save parameters autonomously with the exception of e.g. the special treatment of the homing of multiturn absolute encoders.

Storing of parameters is only done if a special signature ("save") is written to subindex 1. "save" is equivalent to the unsigned32 - number 65766173h.

21.3.13 Object 1011h: Restore Default Parameters DS301

With this object the default values of parameters according to the communication or device profile are restored. The AKD PDMM gives the possibility to restore all default values.

Index	1011h
Name	restore default parameters
Object code	ARRAY
Data type	UNSIGNED32
Category	optional
Subindex	0
Name	highest sub-index supported
Object code	VAR
Data type	UNSIGNED8
Category	mandatory
Access	R/O
PDO Mapping	not possible
Value range	1
Default value	1
Subindex	1
Name	restore all default parameters (DRV.RSTVAR)
Object code	VAR
Data type	UNSIGNED32
Category	mandatory
Access	R/W
PDO Mapping	not possible
Value range	UNSIGNED32
Default value	1 (device restores parameter)

Restoring default parameters to the RAM will be done, if a special signature ("load") is written to subindex 1. "load" has to be transmitted as unsigned32 - number 64616F6Ch.

21.3.14 Object 1012h: COB-ID of the Time Stamp (DS301)

This object defines the COB-ID of the time stamp.

Index	1012h
Name	COB-ID for the time stamp
Object code	VAR
Data type	UNSIGNED32
Category	optional
Access	R/W
PDO mapping	not possible
Value range	UNSIGNED32
Default value	100h

Bit coded information:

Bit	Content	Value	Meaning
31 (MSB)	consume	0	Drive does not consume time message
		1	Drive does consume time message
30	produce	0	Drive does not produce time message
		1	Drive does produce time message
29	frame	0	Value fixed to 0
28 to 11	reserved	–	reserved
10 to 0 (LSB)	CAN-ID	0h - 800h	COB-ID of the time stamp

21.3.15 Object 1014h: COB-ID for Emergency Message (DS301)

This object defines the COB-ID of the Emergency message.

Index	1014h
Name	COB-ID emergency message
Object code	VAR
Data type	UNSIGNED32
Category	conditional; mandatory, if Emergency is supported
Access	R/O
PDO mapping	not possible
Value range	UNSIGNED32
Default value	80h + Node - ID

21.3.16 Object 1016h: Consumer Heartbeat Time

The consumer heartbeat time defines the expected heartbeat cycle time (ms) and must be higher than the corresponding producer heartbeat time configured on the device producing this heartbeat. Monitoring starts after the reception of the first heartbeat. If the consumer heartbeat time is 0 ms the corresponding entry is not used.

Index	1016h
Name	consumer heartbeat time
Object code	ARRAY
Data type	UNSIGNED32
Category	optional
Subindex	0
Description	highest sub-index supported
Data type	UNSIGNED8
Category	mandatory
Access	R/O
PDO Mapping	not possible
Value range	1
Default value	1
Subindex	1
Description	Consumer heartbeat time
Category	mandatory
Access	R/W
PDO Mapping	not possible
Value range	unsigned 32
Default value	0

Definition of the entry value of Subindex 1

	MSB				LSB	
Value	reserved (value: 00)		Node-ID		heartbeat time	
Encoded as	-		UNSIGNED8		UNSIGNED16	
Bit	31	24	23	16	15	0

21.3.17 Object 1017h: Producer Heartbeat Time

The producer heartbeat time defines the cycle time of the heartbeat in ms. If it's 0, it is not used.

Index	1017h
Name	Producer heartbeat time
Object code	VAR
Data type	UNSIGNED16
Category	conditional; mandatory, if guarding is not supported
Access	R/W
PDO mapping	not possible
Value range	UNSIGNED16
Default value	0

21.3.18 Object 1018h: Identity Object (DS301)

The Identity Object contains general device information.

Index	1018h
Name	Identity Object
Object code	RECORD
Data type	Identity
Category	mandatory
Subindex	0
Description	highest sub-index supported
Data type	UNSIGNED8
Category	mandatory
Access	R/O
PDO mapping	not possible
Value range	1 to 4
Default value	4

Subindex 1 is a unique number for a device manufacturer.

Subindex	1
Description	Vendor ID
Category	mandatory
Access	R/O
PDO mapping	not possible
Value range	UNSIGNED32
Default value	0x6Ah (Kollmorgen)

Subindex 2 contains four ASCII - characters, which determine the voltage range and current class of the device. The voltage range is one character L, M or H for low, medium and high voltage. The next three characters are showing the continuous current of the drive.

Subindex	2
Description	Product Code
Category	optional
Access	R/O
PDO mapping	not possible
Value range	e.g. M006 for an MV6 drive
Default value	no

Subindex 3 consists of two revision numbers:

- the major revision number in the upper word containing the CAN-version
- the minor revision number is not used in the AKD PDMM. The firmware version can be retrieved as a string via object 0x100A or as numbers via object 0x2018 subindex 1 to 4.

E.g. a value of 0x0014 0000 means CAN-version 0.20.

Subindex	3
Description	Revision Number
Category	optional
Access	R/O
PDO mapping	not possible
Value range	UNSIGNED32
Default value	no

Subindex 4 gives the serial number of the drive. This number contains the following information in it:

- bits 0..14: Board serial number (production in week of year)
- bits 15..20: week of production
- bits 21..24: year of production - 2009
- bits 25..31: ASCII-code of MFR-ID

Subindex	4
Description	Serial Number
Category	optional
Access	R/O
PDO mapping	not possible
Value range	UNSIGNED32
Default value	no

21.3.19 Object 1026h: OS Prompt

The OS prompt is used to build up an ASCII - communication channel to the drive.

Index	1026h
Name	OS Prompt
Object code	ARRAY
Data type	UNSIGNED8
Category	optional
Subindex	0
Description	highest sub-index supported
Data type	UNSIGNED8
Category	mandatory
Access	R/O
PDO mapping	not possible
Value range	2
Default value	2

Subindex 1 is used to send one character to the drive.

Subindex	1
Description	StdIn
Category	mandatory
Access	W
PDO mapping	not possible
Value range	UNSIGNED8
Default value	—

Subindex 2 is used to receive one character from the drive.

Subindex	2
Description	StdOut
Category	mandatory
Access	R/O
PDO mapping	not possible
Value range	UNSIGNED8
Default value	0

21.3.20 Objects 1400-1403h: 1st - 4th RxPDO communication parameter (DS301)

1400h to 1403h for RxPDO 1 to 4

Index	1400h 1401h 1402h 1403h
Name	receive PDO parameter
Object code	RECORD
Data type	PDO CommPar
Category	mandatory

Defined sub-indices

Subindex	0	
Name	highest sub-index supported	
Data type	UNSIGNED8	
Category	mandatory	
Access	R/O	
PDO Mapping	not possible	
Value Range	2	
Default Value	2	
Subindex	1	
Name	COB-ID used by PDO	
Category	mandatory	
Access	R/W	
PDO Mapping	not possible	
Value Range	UNSIGNED32	
Default Value	Index 1400h: 200h + Node-ID Index 1402h: 400h + Node-ID	Index 1401h: 300h + Node-ID Index 1403h: 500h + Node-ID

Subindex 1 contains the COB-Id of the PDO as a bit coded information:

Bit	Value	Meaning
31	0	PDO exists/is valid
	1	PDO does not exist/is not valid
30	0	RTR allowed on this PDO, not to be used (Can in Automation organisation)
	1	RTR not allowed on this PDO
29	0	11 bit-ID (CAN 2.0A)
	1	29 bit-ID (CAN 2.0B), not supported
28 to 11	X	Identifier-bits with 29 bit-ID, not relevant
10 to 0	X	Bits 10-0 of COB-ID

Subindex	2
Name	transmission type
Category	mandatory
Access	R/W
PDO Mapping	not possible
Value Range	UNSIGNED8
Default Value	FFh

Subindex 2 contains the transmission type of the PDO. There are two ways of setting:

- the value FFh or 255 for event-triggered PDO, which is directly interpreted by reception and taken into actions,
- values from 0 to 240, which cause a SYNC-telegram-controlled interpretation of the PDO contents. Values of 1 to 240 mean, that 0 to 239 SYNC-telegrams are ignored, before one is interpreted. The value 0 means, that only the next SYNC-telegram is interpreted.

21.3.21 Objects 1600-1603h: 1st - 4th RxPDO mapping parameter (DS301)

1600h to 1603h for RxPDO 1 to 4.

Index	1600h 1601h 1602h 1603h
Name	receive PDO mapping
Object Code	RECORD
Data Type	PDO Mapping
Category	mandatory
Subindex	0
Name	highest sub-index supported
Data type	UNSIGNED8
Category	mandatory
Access	R/W
PDO Mapping	not possible
Value Range	0: PDO is not active 1 - 8: PDO activated, mappings are taken only byte-wise
Default Value	PDO1: 1 PDO2: 2 PDO3: 2 PDO4: 2
Subindex	1 - 8
Name	PDO - mapping for the n-th application object
Category	Conditional, depends on number and size of object be mapped
Access	R/W
PDO Mapping	not possible

Value Range	UNSIGNED32
Default Value	See below

21.3.22 Objects 1800-1803h: 1st - 4th TxPDO communication parameter (DS301)

1800h to 1803h for TxPDO 1 to 4.

Index	1800h 1801h 1802h 1803h
Name	transmit PDO parameter
Object code	RECORD
Data type	PDO CommPar
Category	mandatory

Subindex	0
Name	highest sub-index supported
Data type	UNSIGNED8
Category	mandatory
Access	R/O
PDO Mapping	not possible
Value Range	5
Default Value	5

Subindex	1
Name	COB-ID used by PDO
Category	mandatory
Access	R/W
PDO Mapping	not possible
Value Range	UNSIGNED32
Default Value	Index 1800h: 180h + Node-ID Index 1801h: 280h + Node-ID Index 1802h: 380h + Node-ID Index 1803h: 480h + Node-ID

Subindex	2
Name	transmission type
Category	mandatory
Access	R/W
PDO Mapping	not possible
Value Range	UNSIGNED8
Default Value	FFh

Subindex	3
Name	inhibit time
Category	optional
Access	R/W
PDO Mapping	not possible
Value Range	UNSIGNED16 (n*1/10ms)
Default Value	0h

Subindex	4
Name	reserved
Category	optional
Access	R/W
PDO Mapping	not possible
Value Range	0
Default Value	0

Subindex	5
Name	event timer
Category	optional
Access	R/W
PDO Mapping	not possible
Value Range	UNSIGNED16 (0=not used, ms)
Default Value	0h

Subindex 1 contains the COB-Id of the PDO as a bit coded information:

Bit-Number	Value	Meaning
31	0	PDO exists/is valid
	1	PDO does not exist/is not valid
30	0	RTR allowed on this PDO, not supported
	1	RTR not allowed on this PDO, not supported
29	0	11 bit-ID (CAN 2.0A)
	1	29 bit-ID (CAN 2.0B), not supported
28 to 11	X	Identifier-bits with 29 bit-ID, not relevant
10 to 0	X	Bits 10-0 of COB-ID

Subindex 2 contains the transmission type of the PDO. There are two ways of setting:

- A value of FFh or 255d for an event-triggered PDO, which is sent immediately after a change in the mapped application objects. Setting of Subindex 3 or 5 has an influence on the sending of a PDO. With Subindex 3 you can configure, in which minimal time the so configured Transmit-PDOs are sent, if PDO-data contents change (reduction of bus-load). With Subindex 5 (event time) a timer is used, which is reset with every event-triggered sending of this PDO. If there is no change of the PDO-content in this time, the PDO is sent caused by this timer event.
- Values from 0 to 240 cause a SYNC-Telegram controlled sending of the PDO.
- Values from 1 to 240 define how often the SYNC-telegram leads to a sending of a PDO.
- The value 0 means, that only the next SYNC-telegram leads to a sending of the so configured PDOs.

21.3.23 Objects 1A00-1A03h: 1st - 4th TxPDO mapping parameter (DS301)

1A00h to 1A03h for TxPDO 1 to 4.

Index	1A00h 1A01h 1A02h 1A03h
Name	transmit PDO mapping
Object Code	RECORD
Data Type	PDO Mapping
Category	mandatory
Subindex	0
Name	number of mapped application objects in PDO
Data type	UNSIGNED8
Category	mandatory
Access	R/W
PDO Mapping	not possible
Value Range	0: PDO is not active 1 - 8: PDO activated, mappings are taken only byte-wise
Default Value	PDO1: 1 PDO2: 2 PDO3: 2 PDO4: 2
Subindex	1 - 8
Name	PDO - mapping for the n-th application object
Category	Conditional, depends on number and size of object be mapped
Access	R/W
PDO Mapping	not possible
Value Range	UNSIGNED32
Default Value	See below

21.3.24 Object 1C12h: RxPDO assign (DS301)

This object is used to define the mapping for receive direction of EtherCAT data. Either one of the fixed RxPDO mappings 1701h to 1724h is chosen or 1 to 4 of the free mappings 1600h to 1603h.

Index	1C12h
Name	RxPDO assign
Object code	ARRAY
Data type	UNSIGNED16
Category	optional

Defined sub-indices

Subindex	0
Name	highest sub-index supported
Data type	UNSIGNED8
Category	mandatory
Access	R/W
PDO Mapping	not possible
Value Range	0: pdo not active, 1-4 PDO activated
Default Value	1

Subindex	1 to 4
Name	Subindex 001..004
Data type	UNSIGNED8
Category	optional
Access	R/W
PDO Mapping	not possible
Value Range	UNSIGNED16
Default Value	1701h via ESI-file

21.3.25 Object 1C13h: TxPDO assign (DS301)

This object is used to define the mapping for transmit direction of EtherCAT data. Either one of the fixed TxPDO mappings 1B01h to 1B25h is chosen or 1 to 4 of the free mappings 1A00h to 1A03h.

Index	1C13h
Name	TxPDO assign
Object code	ARRAY
Data type	UNSIGNED16
Category	optional

Defined sub-indices

Subindex	0
Name	highest sub-index supported
Data type	UNSIGNED8
Category	mandatory
Access	R/O
PDO Mapping	not possible
Value Range	0: pdo not active, 1-4 PDO activated
Default Value	1

Subindex	1 to 4
Name	Subindex 001..004
Data type	UNSIGNED16
Category	optional
Access	R/W
PDO Mapping	not possible
Value Range	UNSIGNED16
Default Value	1B01h via ESI-file

21.3.26 Object 2000h: System Warnings

This object is used to show up to three actual warnings with their AKD PDMM- specific warning number.

Index	2000h
Name	System Warnings
Object code	ARRAY
Data type	UNSIGNED32
Subindex	0
Description	highest sub-index supported
Category	mandatory
Access	R/O
PDO mapping	not possible
Value range	3
Default value	3
Subindex	1 to 3
Description	DRV.WARNING1 to DRV.WARNINGS3
Mode	independent
Access	R/O
PDO mapping	not possible
Unit	—
Value range	0 to 999
Default value	0

21.3.27 Object 2001h: System Faults

This object is used to show up to ten actual faults with their AKD PDMM- specific fault number.

Index	2001h
Name	System Faults
Object code	ARRAY
Data type	UNSIGNED32
Subindex	0
Description	highest sub-index supported
Category	mandatory
Access	R/O
PDO mapping	not possible
Value range	0xA
Default value	0xA
Subindex	1 to A
Description	DRV.FAULT1 to DRV.FAULT10
Mode	independent

Access	R/O
PDO mapping	not possible
Unit	—
Value range	0 to 999
Default value	0

21.3.28 Object 2002h: Manufacturer status bytes

This objects delivers the information of the manufacturer status (object 0x1002 sub 0) as four separate, map-pable, bytes.

Index	2002h
Name	Manufacturer status bytes
Object code	ARRAY
Data type	UNSIGNED8
Subindex	0
Description	highest sub-index supported
Category	mandatory
Access	R/O
PDO mapping	not possible
Value range	0x4
Default value	0x4
Subindex	1 to 4
Description	Manufacturer status byte 1 to Manufacturer status byte 4
Mode	independent
Access	R/O
PDO mapping	possible
Unit	—
Value range	0 to 0xFF
Default value	-

21.3.29 Object 2011h: DRV.RUNTIME in seconds

This object delivers the runtime of the drive in seconds.

Index	2011h
Name	DRV.RUNTIME in seconds
Object code	VAR
Data type	UNSIGNED32
Access	R/O
Unit	—
Value range	UNSIGNED32
Default value	0

21.3.30 Object 2012h: Fault history: Fault numbers

This object delivers the 20 latest entries of the fault numbers of the fault history table. The latest event can be read via sub-index 1. With new events the list is shifted to higher sub-indices.

Index	2012h
Name	Fault history: Fault numbers
Object code	ARRAY
Data type	UNSIGNED32
Subindex	0
Description	highest sub-index supported
Category	mandatory
Access	R/O
PDO mapping	not possible
Value range	0x14h
Default value	0x14h
Subindex	1 to 20
Description	Nth-latest entry in fault number list of fault history table (DRV.FAULHIST)
Mode	independent
Access	R/O
PDO mapping	not possible
Unit	—
Value range	0 - 999
Default value	0

21.3.31 Object 2013h: Fault history: Time stamps

This object delivers the 20 latest entries of the fault time stamps of the fault history table in seconds related to DRV.RUNTIME. The latest event can be read via sub-index 1. With new events the list is shifted to higher sub-indices.

Index	2013h
Name	Fault history: Time stamps
Object code	ARRAY
Data type	UNSIGNED32
Subindex	0
Description	highest sub-index supported
Category	mandatory
Access	R/O
PDO mapping	not possible
Value range	0x14h
Default value	0x14h
Subindex	1 to 20
Description	Nth-latest entry in fault time stamp list of fault history table (DRV.FAULTHIST)
Mode	independent
Access	R/O
PDO mapping	not possible
Unit	—
Value range	UNSIGNED32
Default value	—

21.3.32 Object 2014-2017h: 1st-4th Mask 1 to 4 for Transmit-PDO

In order to reduce the bus loading with event-triggered PDOs, masking can be used to switch off the monitoring for individual bits in the PDO. In this way it can be arranged, for instance, that actual position values are only signaled once per turn.

This Object masks the PDO-channels 1 to 4. If only two bytes have been defined in a PDO, then it masks just two bytes, although 4 bytes of mask information have been transmitted.

An activated bit in the mask means that monitoring is active for the corresponding bit in the PDO.

Index	2014h 2015h 2016h 2017h
Name	tx_mask 1 to 4
Object code	ARRAY
Data type	UNSIGNED32
Subindex	1
Description	tx_mask1 to 4_low
Mode	independent
Access	R/W
PDO mapping	not possible
Unit	—
Value range	UNSIGNED32
Default value	FFFFFFFFh
Subindex	2
Description	tx_mask1 to 4_high
Mode	independent
Access	R/W
PDO mapping	not possible
Unit	—
Value range	UNSIGNED32
Default value	FFFFFFFFh

21.3.33 Object 2018h: Firmware Version

This object gives all information regarding the firmware version.

Example: Firmware version M_01_00_01_005 would show the numbers 1, 0, 1, 5 in the sub-indices 1 to 4.

Index	2018h
Name	firmware version
Object code	ARRAY
Data type	UNSIGNED16
Subindex	1
Description	major version
Mode	independent
Access	R/O
PDO mapping	not possible
Unit	—
Value range	UNSIGNED16
Default value	0
Subindex	2
Description	minor version
Mode	independent
Access	R/O
PDO mapping	not possible
Unit	—
Value range	UNSIGNED16
Default value	0
Subindex	3
Description	revision
Mode	independent
Access	R/O
PDO mapping	not possible
Unit	—
Value range	UNSIGNED16
Default value	0
Subindex	4
Description	branch revision
Mode	independent
Access	R/O
PDO mapping	not possible
Unit	—
Value range	UNSIGNED16
Default value	0

21.3.34 Object 2026h: ASCII Channel

This object is used to build up an ASCII - communication channel to the drive with 4-byte ASCII-strings.

Index	2026h
Name	ASCII Channel
Object code	ARRAY
Data type	Visible String
Category	optional
Subindex	0
Description	highest sub-index supported
Data type	UNSIGNED8
Category	mandatory
Access	R/O
PDO mapping	not possible
Value range	2
Default value	2

Subindex 1 is used to send four ASCII-characters to the drive.

Subindex	1
Description	Command
Category	mandatory
Access	wo
PDO mapping	no
Value range	Visible String
Default value	—

Subindex 2 is used to receive four characters from the drive.

Subindex	2
Description	Response
Category	mandatory
Access	R/O
PDO mapping	no
Value range	Visible String
Default value	-

21.3.35 Object 204Ch: PV Scaling Factor

This object shall indicate the configured numerator and denominator of the pv scaling factor. The pv scaling factor serves to modify the resolution or directing range of the specified setpoint. It is also included in calculation of the vl velocity demand, and vl velocity actual value. It does not influence the velocity limit function and the ramp function. The value shall have no physical unit and shall be given in the range from -32 768 to +32 767, but the value of 0 shall not be used.

The velocity scaling factor is only active, when bit 4 of FBUS.PARAM05 is set to 1. Otherwise velocities are scaled as 1/1000 rpm.

Index	204Ch
Name	pv scaling factor
Object code	ARRAY
Data type	INTEGER32
Category	optional
Subindex	0
Description	highest sub-index supported
Data type	UNSIGNED8
Category	mandatory
Access	R/O
PDO mapping	not possible
Value range	2
Default value	no
Subindex	1
Description	pv scaling factor numerator
Category	optional
Access	R/W
PDO mapping	not possible
Value range	INTEGER32
Default value	+1
Subindex	2
Description	pv scaling factor denominator
Category	optional
Access	R/W
PDO mapping	not possible
Value range	INTEGER32
Default value	+1

21.3.36 Object 2071h: Target Current

This parameter can be used alternatively to the DS402 parameter 6071h and is the input to the torque controller. The value is scaled in mA (milli Amperes).

Index	2071h
Name	Target current
Object code	VAR
Data type	INTEGER 32
Category	optional
Access	RW
PDO mapping	possible
Value range	depends on DRV.IPEAK and MOTOR.IPEAK
Default value	0

21.3.37 Object 2077h: Current Actual Value

This parameter can be used alternatively to the DS402 parameter 6077h. The value is scaled in mA (milli Amperes).

Index	2077h
Name	Current actual value
Object code	VAR
Data type	INTEGER 32
Category	optional
Access	RO
PDO mapping	possible
Value range	depends on DRV.IPEAK and MOTOR.IPEAK
Default value	0

21.3.38 Object 20A0h: Latch position 1, positive edge

This object is used to output the position or a time, depending on CAP0.MODE, at which the first positive edge occurred on a signal, which can be configured with CAP0.TRIGGER. The latch enable must be active for that purpose(see object 20A4 and 20A5). With CAP0.MODE = 3 the latched position of the encoder index pulse is transferred via this object.

Index	20A0h
Name	Latch position 1 positive edge CAP0.PLFB, Time capture CAP0.T
Object code	VAR
Data type	INTEGER32
Category	optional
Access	R/O
PDO mapping	possible
Value range	INTEGER32
Float scaling	var

Default value	0
---------------	---

21.3.39 Object 20A1h: Latch position 1, negative edge

This object is used to output the position or a time, depending on CAP0.MODE, at which the first negative edge occurred on a signal, which can be configured with CAP0.TRIGGER. The latch enable must be active for that purpose(see object 20A4 and 20A5).

Index	20A1h
Name	Latch position 1 negative edge CAP0.PLFB, Time capture CAP0.T
Object code	VAR
Data type	INTEGER32
Category	optional
Access	R/O
PDO mapping	possible
Value range	INTEGER32
Float scaling	var
Default value	0

21.3.40 Object 20A2h: Latch position 2, positive edge

This object is used to output the position or a time, depending on CAP1.MODE, at which the first positive edge occurred on a signal, which can be configured with CAP1.TRIGGER. The latch enable must be active for that purpose(see object 20A4 and 20A5).

Index	20A2h
Name	Latch position 2 positive edge CAP1.PLFB, Time capture CAP1.T
Object code	VAR
Data type	INTEGER32
Category	optional
Access	R/O
PDO mapping	possible
Value range	INTEGER32
Float scaling	var
Default value	0

21.3.41 Object 20A3h: Latch position 2, negative edge

This object is used to output the position or a time, depending on CAP1.MODE, at which the first negative edge occurred on a signal, which can be configured with CAP1.TRIGGER. The latch enable must be active for that purpose(see object 20A4 and 20A5).

Index	20A3h
Name	Latch position 2 negative edge CAP1.PLFB, Time capture CAP1.T
Object code	VAR
Data type	INTEGER32
Category	optional
Access	R/O
PDO mapping	possible
Value range	INTEGER32
Float scaling	var
Default value	0

21.3.42 Object 20A4h: Latch Control Register

The latch control register is used to enable the latch monitoring of the capture engines 0 and 1. The latch is enabled with a 1 signal and disabled with a 0 signal. Whether or not a latch event has occurred can be recognised by the latch status register (object 20A5).

Index	20A4h
Name	Latch Control Register
Object code	VAR
Data type	UNSIGNED16
Category	optional
Access	rww
PDO mapping	possible
Value range	0 to 15
Default value	0

Bit	Value (bin)	Value (hex)	Description
0	00000000 00000001	xx01	Enable extern latch 1 (positive rise)
1	00000000 00000010	xx02	Enable extern latch 1 (negative rise)
2	00000000 00000100	xx04	Enable extern latch 2 (positive rise)
3	00000000 00001000	xx08	Enable extern latch 2 (negative rise)
4 to 7			Reserve
8	00000001 00000000	01xx	Read external latch 1 (positive rise)
9	00000010 00000000	02xx	Read external latch 1 (negative rise)
10	00000011 00000000	03xx	Read external latch 2 (positive rise)
11	00000100 00000000	04xx	Read external latch 2 (negative rise)
12 to 15			Reserve

21.3.43 Object 20A5h: Latch Status Register

The latch status register is used to look for the states of the capture engines 0 and 1.

Index	20A5h
Name	Latch Status Register
Object code	VAR
Data type	UNSIGNED16
Category	optional
Access	rwr
PDO mapping	possible
Value range	-
Default value	0

Bit	Value (bin)	Value (hex)	Description
0	00000000 00000001	zz01	External latch 1 valid (positive rise)
1	00000000 00000010	zz02	External latch 1 valid (negative rise)
2	00000000 00000100	zz04	External latch 2 valid (positive rise)
3	00000000 00001000	zz08	External latch 2 valid (negative rise)
4 to 7			Reserve
8	00000001 00000000	z1zz	Acknowledge value external latch 1 (positive rise)
9	00000010 00000000	z2zz	Acknowledge value external latch 1 (negative rise)
10	00000011 00000000	z3zz	Acknowledge value external latch 2 (positive rise)
11	00000100 00000000	z4zz	Acknowledge value external latch 2 (negative rise)
12	00010000 00000000	1zzz	State Digital Input 4
13	00100000 00000000	2zzz	State Digital Input 3
14	01000000 00000000	4zzz	State Digital Input 2
15	10000000 00000000	8zzz	State Digital Input 1

21.3.44 Object 20A6h: Latch position 1, positive or negative edge

This object is used to output the position or a time, depending on CAP0.MODE, at which the first positive or negative edge occurred on a signal, that can be configured with CAP0.TRIGGER. Latch enable must be active for that purpose (see object 20A4 and 20A5).

Index	20A6h
Name	Latch position 1 positive or negative CAP0.PLFB
Object code	VAR
Data type	INTEGER32
Category	optional
Access	ro
PDO mapping	possible
Value range	INTEGER32
Float scaling	var
Default value	0

21.3.45 Object 20A7h: Latch position 2, positive or negative edge

This object is used to output the position or a time, depending on CAP1.MODE, at which the first positive or negative edge occurred on a signal, that can be configured with CAP1.TRIGGER. Latch enable must be active for that purpose (see object 20A4 and 20A5).

Index	20A7h
Name	Latch position 2 positive or negative CAP1.PLFB
Object code	VAR
Data type	INTEGER32
Category	optional
Access	ro
PDO mapping	possible
Value range	INTEGER32
Float scaling	var
Default value	0

21.3.46 Object 20B8h: Reset of changed input information

This object is used in PDOs to reset the state change information for the digital inputs shown in the Bits 24 to 30 in the object 60FD. Bit 0 to 6 are used to reset the information of the digital input 1 to 7.

Index	20B8h
Name	Reset of changed input information
Object code	VAR
Data type	UNSIGNED16
Category	optional
Access	rw
PDO mapping	possible
Value range	UNSIGNED16
Default value	0

21.3.47 Object 345Ah: Brake Control

These objects implement the possibility to control the brake directly, overriding the drive logic. When the brake state is controlled by the fieldbus, the drive state (enabled, disabled, faulted) will have no effect on the brake - the fieldbus will be in control.



CAUTION

Applying or releasing the brake at the wrong time can be a safety hazard and can destroy your mechanic as well as drive or motor. Unexpected behaviour might be possible. It is the responsibility of the customer using this mode to use this function appropriately.

When fieldbus control is disabled, the drive will control the brake as defined by existing AKD PDMM brake related parameters. As soon as fieldbus control is enabled, the Brake Command received over the field bus will take effect. So, if the Brake Command is set to APPLY and the current state is RELEASE, the brake will begin to apply .

The default value of the fieldbus control will be disabled, so that the drive is always in control until the fieldbus is operational. It is recommended that this bit remain 0 except for special operating conditions where the fieldbus will control the brake. When fieldbus communication is lost, the drive will regain control of the brake if the fieldbus had previously taken control.

Enable Fieldbus Control	Serious Failure condition present	Brake Command	Fieldbus Control Status	Controlled by...	Final Brake State
0	x	x	0	Drive	Drive
1*	no	0	1	Fieldbus	Applied
1*	no	1	1	Fieldbus	Released
x	yes	any	0	Drive	Drive

1* indicates that a rising edge was seen since the last time the drive applied the brake

Index	345Ah
Name	Brake Control
Object code	ARRAY
Data type	UNSIGNED16
Category	optional

Defined sub-indices

Subindex	0
Name	highest sub-index supported
Data type	UNSIGNED8
Category	mandatory
Access	R/O
PDO Mapping	not possible
Value Range	2
Default Value	2

Subindex	1
Name	Brake Control Command
Category	optional
Access	R/W
PDO Mapping	possible
Value Range	UNSIGNED16
Default Value	0

With subindex 1 the brake is controlled. Bit definition:

Bit	Name	Description
0	Enable fieldbus control	0 - brake is not controlled via this object 1 - enable fieldbus control via this object. This function works edge triggered, i.e. this bit has to have a 0 -> 1 transition to activate the brake control functionality. After a fault the functionality is reset and has to be activated again. The activation can be controlled by subindex 2 bit 0.
1	Brake Command	This command bit is only active, if the functionality was activated via bit 0. The function is as follows: 0 - apply the brake 1 - release the brake

Subindex	2
Name	Brake Status Response
Category	optional
Access	R/O
PDO Mapping	possible
Value Range	UNSIGNED16
Default Value	0

With subindex 2 the brake status can be checked. Bit definition:

Bit	Name	Description
0	Fieldbus control Status	0 - brake control via 0x345A is disabled or not possible due to drive failure. 1 - enable fieldbus control via this object. This function works edge triggered, i.e. this bit has to have a 0 -> 1 transition to activate the brake control functionality. After a fault the functionality is reset and has to be activated again. The activation can be controlled by subindex 2 bit 0.
1	Brake Status	0 - apply the brake 1 - release the brake Note: When the brake is applied or released, there is a time delay MOTOR.TBRAKEAPP or MOTOR.TBRAKEREL, after the receipt of the command before this status bit changes. The status is always reported: it is not affected by fieldbus control.

2	STO Status	0 - STO is not active (drive may be enabled) 1 - STO is active (drive can not be enabled)
3	HW Enable Status	0 - HW enable is disabled, drive function can not be enabled 1 - HW enable is enabled, drive function can be enabled

21.3.48 Object 3474h: Parameters for digital inputs

This set of objects is used to set extended parameters for some digital input functions. The parameters can be used for different DINx.MODEs. Therefore the scaling might be different or no scaling is used at all.

Two subindices build an access object to one of these parameters, because they are 64-bit numbers internally, e.g. object 3474 sub 1 gives access to the low 32 bits of DIN1.PARAM whereas 3474 sub 8 sub 4 gives access to the high 32 bits.

If access to the whole 64 bit number is needed the higher bits must be written first. The access to the lower 32 bits then writes the parameter. If the to be written value fits into 32 bit, only the lower part needs to be written. The most-significant bit is then taken as sign-bit for the number.

Index	3474h
Name	DINx.PARAM
Object code	Array
Data type	UNSIGNED32
Category	optional
Subindex	0
Description	highest sub-index supported
Category	mandatory
Access	R/O
PDO mapping	not possible
Value range	0xE
Default value	0xE
Subindex	1 to 7 1 to 3
Description	DINx.PARAM low 32 bits, x = 1 .. 7 1 .. 3
Category	optional
Access	R/W
PDO mapping	not possible
Value range	UNSIGNED32
Default value	0
Subindex	8 to 0xE 4 to 6
Description	DINx.PARAM high 32 bits, x = 1 .. 7 1 .. 3
Category	optional
Access	R/W
PDO mapping	not possible
Value range	UNSIGNED32
Default value	0

21.3.49 Object 3475h: Parameters for digital outputs

This set of objects is used to set extended parameters for some digital output functions. The parameters can be used for different DOUTx.MODEs. Therefore the scaling might be different or no scaling is used at all.

Two subindices build an access object to one of these parameters, because they are 64-bit numbers internally, e.g. object 3475 sub 1 gives access to the low 32 bits of DOUT1.PARAM whereas 3475 sub 32 gives access to the high 32 bits.

If access to the whole 64 bit number is needed the higher bits must be written first. The access to the lower 32 bits then writes the parameter. If the to be written value fits into 32 bit, only the lower part needs to be written. The most-significant bit is then taken as sign-bit for the number.

Index	3475h
Name	DOUTx.PARAM
Object code	Array
Data type	UNSIGNED32
Category	optional
Subindex	0
Description	highest sub-index supported
Category	mandatory
Access	R/O
PDO mapping	not possible
Value range	0x4
Default value	0x4
Subindex	1 to 2
Description	DOUTx.PARAM low 32 bits, x = 1 .. 2
Category	optional
Access	R/W
PDO mapping	not possible
Value range	UNSIGNED32
Default value	0
Subindex	3 to 42
Description	DOUTx.PARAM high 32 bits, x = 1 .. 2
Category	optional
Access	R/W
PDO mapping	not possible
Value range	UNSIGNED32
Default value	0

21.3.50 Object 3496h: Fieldbus synchronization parameters

This set of objects is used to set or read parameters for the fieldbus synchronization used in the interpolated position mode (7) and the cyclic-modes 8 etc. The synchronization between a fieldbus master and the AKD PDMM is similar in all the supported fieldbus systems.

The AKD PDMM internal 16[kHz] interrupt function is responsible for calling the PLL function. This PLL function is called once per fieldbus cycle (set by object 60C2 sub 1 and 2). If the fieldbus sample period is for example 1[ms], the PLL code is called every 16th time of the 16[kHz] IRQ of the AKD PDMM.

Once in a fieldbus sample the SYNC-telegram must arrive, which resets a PLL counter in the Drive. After some time the already mentioned PLL function is called and reads back the time from that PLL counter.

Depending on the measured time the PLL function extends (in case that the measured time is too low) or lowers (in case that the measured time is too high) the sample time of the upcoming 16[kHz] tasks for one fieldbus sample by a selectable value (object 3496 sub 4) in order to move the PLL function closer to the expected distance (object 3496 sub 1).

Beside the objects mentioned here the parameter FBUS.SAMPLEPERIOD is important, which is set by object 60C2 sub 1 and 2. This setting is required in order to share the fieldbus sample time with the slave. This information is e.g. needed for being able to call the AKD PDMM internal PLL function once per fieldbus sample.

Index	3496h
Name	FBUS synchronization parameters
Object code	Array
Data type	UNSIGNED32
Category	optional
Subindex	0
Description	highest sub-index supported
Category	mandatory
Access	R/O
PDO mapping	not possible
Value range	0x4
Default value	0x4
Subindex	1
Description	FBUS.SYNCDIST
Category	optional
Access	R/W
PDO mapping	not possible
Value range	UNSIGNED32
Default value	320000 [ns]

Sub 1 is the expected time distance in nano seconds between clearing the PLL counter and calling the PLL function.

Subindex	2
Description	FBUS.SYNCACT
Category	optional
Access	R/W
PDO mapping	not possible
Value range	UNSIGNED32
Default value	320000 [ns]

Sub 2 is the actual time distance in nano seconds between clearing the PLL counter and calling the PLL function.

Subindex	3
Description	FBUS.SYNCWND
Category	optional
Access	R/W
PDO mapping	not possible
Value range	UNSIGNED32
Default value	70000 [ns]

Sub 3 is a window, which is used in order to consider the drive as being synchronized. The AKD PDMM is considered as synchronized in the following case:

$$\text{FBUS.SYNCDIST} - \text{FBUS.SYNCWND} < \text{FBUS.SYNCACT} < \text{FBUS.SYNCDIST} + \text{FBUS.SYNCWND}$$

Subindex	4
Description	FBUS.COMPTIME
Category	optional
Access	R/W
PDO mapping	not possible
Value range	UNSIGNED32
Default value	150 [ns]

Sub 4 value indicates the time, which is used for extending or lowering the sample rate of the AKD PDMM internal 16[kHz] IRQ, which is responsible for calling the PLL function. The default sample time is $32 * 1/16$ [kHz] = 2[ms].

The sample time of the AKD PDMM high prior interrupt is determined by $62.5[\mu\text{s}] - \text{FBUS.COMPTIME}$ if $\text{FBUS.SYNCACT} > \text{FBUS.SYNCDIST}$.

The sample time of the AKD PDMM high prior interrupt is determined by $62.5[\mu\text{s}] + \text{FBUS.COMPTIME}$ if $\text{FBUS.SYNCACT} < \text{FBUS.SYNCDIST}$.

21.3.51 Object 6040h: Control word (DS402)

The control commands are built up from the logical combination of the bits in the control word and external signals (e.g enable output stage). The definitions of the bits are shown below:

Index	6040h
Name	control word
Object code	VAR
Data type	UNSIGNED16
Access	R/W
PDO mapping	possible
Unit	—
Value range	0 to 65535
EEPROM	no
Default value	0

Bit assignment in control word

Bit	Name	Bit	Name
0	Switch on	8	Pause/halt
1	Disable Voltage	9	reserved
2	Quick Stop	10	reserved
3	Enable Operation	11	reserved
4	Operation mode specific	12	reserved
5	Operation mode specific	13	Manufacturer-specific
6	Operation mode specific	14	Manufacturer-specific
7	Reset Fault (only effective for faults)	15	Manufacturer-specific

Commands in the control word

Command	Bit 7 Fault Reset	Bit 3 Enable Operation	Bit 2 Quick Stop	Bit 1 Disable Voltage	Bit 0 Switch on	Transitions
Shutdown	X	X	1	1	0	2, 6, 8
Switch on	X	X	1	1	1	3
Disable Voltage	X	X	X	0	X	7, 9, 10, 12
Quick Stop	X	X	0	1	X	7, 10, 11
Disable Operation	X	0	1	1	1	5
Enable Operation	X	1	1	1	1	4, 16
Fault Reset	1	X	X	X	X	15

Bits marked by an X are irrelevant.

Mode-dependent bits in the control word

The following table shows the mode-dependent bits in the control word. Only manufacturer-specific modes are supported at present. The individual modes are set by Object 6060_n Modes of operation.

Operation mode	No.	Bit 4	Bit 5	Bit 6
Profile Position Mode (pp)	01h	new_setpoint	change_set_immediately	absolute/relative
Profile Velocity Mode (pv)	03h	reserved	reserved	reserved
Profile Torque Mode (tq)	04h	reserved	reserved	reserved
Homing Mode (hm)	06h	homing_operation_start	reserved	reserved
Interpolated Position Mode (ip)	07h	Enable Interpolation	reserved	reserved
Cyclic sync position Mode (csp)	08h	reserved	reserved	reserved

Description of the remaining bits in the control word

The remaining bits in the control word are described below.

Bit 8 Pause If Bit 8 is set, then the drive halts (pauses) in all modes. The setpoints (speed for homing or jogging, motion task number, setpoints for digital mode) for the individual modes are retained.

Bit 9,10 These bits are reserved for the drive profile (DS402).

Bit 13, 14, 15 These bits are manufacturer-specific, and reserved at present.

21.3.52 Object 6041h: Status word (DS402)

The momentary state of the state machine can be read out with the aid of the status word.

Index	6041h
Name	Status word
Object code	VAR
Data type	UNSIGNED16
Access	R/W
PDO mapping	possible
Unit	—
Value range	0 to 65535
EEPROM	yes
Default value	0

Bit assignment in the status word

Bit	Name	Bit	Name
0	Ready to switch on	8	Manufacturer-specific (reserved)
1	Switched on	9	Remote
2	Operation enabled	10	Target reached
3	Fault	11	Internal limit active
4	Voltage enabled	12	Operation mode specific (reserved)
5	Quick stop	13	Operation mode specific (reserved)

6	Switch on disabled	14	Manufacturer-specific (reserved)
7	Warning	15	Manufacturer-specific (reserved)

States of the state machine

State	Bit 6 switch on disabled	Bit 5 quick stop	Bit 3 fault	Bit 2 operation enabled	Bit 1 switched on	Bit 0 ready to switch on
Not ready to switch on	0	X	0	0	0	0
Switch on disabled	1	X	0	0	0	0
Ready to switch on	0	1	0	0	0	1
Switched on	0	1	0	0	1	1
Operation enabled	0	1	0	1	1	1
Fault	0	X	1	0	0	0
Fault reaction active	0	X	1	1	1	1
Quick stop active	0	0	0	1	1	1

Bits marked by X are irrelevant

Description of the remaining bits in the status word

Bit 4: voltage_enabled The DC-link voltage is present if this bit is set.

Bit 7: warning There are several possible reasons for Bit 7 being set and this warning being produced. The reason of a warning can be seen by the Error code of the Emergency message, which is sent on the bus caused by this warning.

Bit 9: The remote-bit is set by the telnet command FBUS.REMOTE. The default state is 1 indicating that the power stage shall be only controlled by the DS402 control word. For special actions via telnet like tuning or commutation finding, FBUS.REMOTE shall be set to 0 via telnet to inform the fieldbus master.

Bit 10: target_reached This is set when the drive has reached the target position.

Bit 11: internal_limit_active This bit specifies that a movement was or is limited. In different modes, different warnings cause the bit to be set. The following assignments exist:

Mode of operation	Warnings which set Bit 11
all	n04, n06, n07, n10, n11, n14
0x1 (PP), 0x88	n03, n08, n09, n20

Mode-dependent bits in the status word

The following table shows the mode-dependent bits in the status word. The individual modes are set by " Object 6060h: Modes of Operation (DS402)" (→ p. 1027).

Operation mode	No.	Bit 12	Bit 13
Profile Position Mode (pp)	01h	setpoint acknowledge	following error
Homing Mode (hm)	06h	homing attained	homing error
Interpolated Position Mode (ip)	07h	ip mode active	following error
Cyclic sync position Mode (csp)	08h	This bit stays on 1 as long as the drive is following the position set-points.	following error

21.3.53 Object 6060h: Modes of Operation (DS402)

This object is used to set the mode, which can be read out by Object 6061h. Two types of operating mode are used:

- manufacturer-specific operating modes
- operating modes as per CANopen drive profile DS402

These operating modes are defined in the CANopen drive profile DS402. After the mode has been changed, the corresponding setpoint must be set once more (for instance, the homing velocity in the mode homing_setpoint). If the position or jogging mode is stored, then the Homing mode is set after a RESET of the drive.

NOTE

An operating mode only becomes valid when it can be read by Object 6061h.



WARNING

Never change the mode while the motor is running! The drive could move unexpectedly. When the drive is enabled, a mode change is only permissible at zero speed. Set the speed setpoint to 0 before changing over.

Index	6060h
Name	mode of operation
Object code	VAR
Data type	INTEGER8
Category	mandatory
Access	R/W
PDO mapping	possible
Value range	-3, -2, -1, 1, 3, 4, 6, 7, 8
Default value	—

Supported modes (negative values are manufacturer specific modes):

Value (hex)	Mode
-3	Analog current mode
-2	Analog velocity mode
-1	Electronic gearing mode
1	Profile position mode
3	Profile velocity mode
4	Profile torque mode
6	Homing mode
7	Interpolated position mode
8	Cyclic synchronous position mode

21.3.54 Object 6061h: Modes of Operation Display (DS402)

This object can be used to read the mode that is set by Object 6060h. An operating mode only becomes valid when it can be read by Object 6061h (see also Object 6060h).

Index	6061h
Name	mode of operation display
Object code	VAR
Data type	INTEGER8
Category	mandatory
Access	R/O
PDO mapping	possible
Value range	-3, -2, -1, 1, 3, 4, 6, 7, 8
Default value	—

21.3.55 Object 6063h: position actual value* (DS402)

The object position actual value provides the momentary actual position in increments. The resolution is defined with Object 608F as power-of-two number.

Index	6063h
Name	position actual value
Object code	VAR
Data type	INTEGER32
Mode	pc, pp
Access	R/W
PDO mapping	possible
Unit	increments (1 turn = 2^{PRBASE})
Value range	(-2^{31}) to $(2^{31}-1)$
Default value	2^{20}
EEPROM	no

21.3.56 Object 6064h: position actual value (DS402)

The object position actual value provides the actual position. The resolution can be altered by the gearing factors of the position controller (Object 6091/6092).

Index	6064h
Name	position actual value, PL.FB
Object code	VAR
Data type	INTEGER32
Mode	pp, csp
Access	R/W
PDO mapping	possible
Unit	position units

Value range	(-2^{31}) to $(2^{31}-1)$
Default value	—
EEPROM	no

21.3.57 Object 6065h: Following error window

The following error window defines a range of tolerated position values symmetrically to the position demand value. A following error might occur when a drive is blocked, unreachable profile velocity occurs, or at wrong closed loop coefficients. If the value of the following error window is 0, the following control is switched off.

Index	6065h
Name	Following error window
Object code	VAR
Data type	UNSIGNED32
Category	optional
Access	R/W
PDO mapping	not possible
Value range	UNSIGNED32
Default value	0

21.3.58 Object 606Ch: Velocity actual value (DS402)

The object velocity actual value represents the actual speed.

Index	606Ch
Name	velocity actual value, VL.FB
Object code	VAR
Data type	INTEGER32
Mode	pv
Access	R/O
PDO mapping	possible
Unit	velocity units (SDO is in user units and the PDO is in RPM)
Value range	(-2^{31}) to $(2^{31}-1)$
Default value	—
Float scaling	1000:1
EEPROM	no

21.3.59 Object 6071h: Target torque (DS402)

This parameter is the input value for the torque controller in profile torque mode and the value is given per thousand (1‰) of rated torque.

Index	6071h
Name	Target torque
Object code	VAR
Data type	INTEGER16
Category	conditional; mandatory, if tq supported
Access	R/W
PDO mapping	possible
Value range	INTEGER16
Default value	0

21.3.60 Object 6073h: Max current (DS402)

This value represents the maximum permissible torque creating current in the motor and is given per thousand (1‰) of rated current.

Index	6073h
Name	Max current
Object code	VAR
Data type	UNSIGNED16
Category	optional
Access	R/W
PDO mapping	not possible
Value range	UNSIGNED16
Default value	0

21.3.61 Object 6077h: Torque actual value (DS402)

The torque actual value corresponds to the instantaneous torque in the drive motor. The value is given per thousand (1‰) of rated torque.

Index	6077h
Name	Torque actual value
Object code	VAR
Data type	INTEGER16
Category	optional
Access	R/O
PDO mapping	possible
Value range	INTEGER16
Default value	0

21.3.62 Object 607Ah: Target position (DS402)

The object target position defines the target position for the drive. The target position is interpreted as a relative distance or an absolute position, depending on Bit 6 of the control word. The type of relative movement can be further defined by the manufacturer-specific parameter 35B9h Subindex 0. Other properties like following motion tasks can be set with this object as well. The mechanical resolution is set via the scaling objects 6091h and 6092h.

Index	607Ah
Name	target position, MT.P
Object code	VAR
Data type	INTEGER32
Mode	pp, csp
Access	R/W
PDO mapping	possible
Unit	user-defined
Value range	$-(2^{31}-1)$ to $(2^{31}-1)$
Default value	—

21.3.63 Object 607Ch: Homing offset (DS402)

The reference offset (home offset) is the difference between the zero position for the application and the zero point of the machine. All subsequent absolute motion tasks take account of the reference offset.

Index	607Ch
Name	home offset, HOME.P
Object code	VAR
Data type	INTEGER32
Mode	hm
Access	R/W
PDO mapping	not possible
Unit	user-defined
Value range	(-2^{31}) to $(2^{31}-1)$
Default value	0

21.3.64 Object 607Dh: Software position limit (DS402)

Software position limit contains the sub-parameters min position limit and max position limit. New target positions are checked against these limits. The limits are relative to the machine home position, which is the result of homing (including the home offset (Object 607Ch)). As default the software position limits are switched off. Changed values must be saved and the drive must be restarted to take enable the new the software limits.

Index	607Dh
Name	Software position limit, SWLS.LIMIT0
Object code	ARRAY
Data type	INTEGER32
Category	optional
Subindex	0
Description	highest sub-index supported
Category	mandatory
Access	R/O
PDO mapping	not possible
Value range	2
Default value	2
Subindex	1
Description	min position limit 1, SWLS.LIMIT0
Category	mandatory
Access	R/W
PDO mapping	not possible
Value range	INTEGER32
Default value	0 (switched off)
Subindex	2
Description	Min Position Limit 2, SWLS.LIMIT1
Category	mandatory
Access	R/W
PDO mapping	not possible
Value range	INTEGER32
Default value	0 (switched off)

21.3.65 Object 6081h: Profile velocity (DS402)

The profile velocity is the final velocity that should be reached after the acceleration phase of a motion task.

Index	6081h
Name	profile velocity, MT.V
Object code	VAR
Data type	UNSIGNED32
Mode	pp
Access	R/W
PDO mapping	possible
Unit	speed units
Value range	0 to $(2^{32}-1)$
Default value	10

21.3.66 Object 6083h: Profile acceleration (DS402)

The acceleration ramp (profile acceleration) is given in units that are defined by the user (position units per s²). The position units are scaled via the objects 6091 and 6092. This object is connected to the AKD PDMM-parameter DRV.ACC in the Profile Velocity Mode and to the motion task parameter MT.ACC in all other modes.

Index	6083h
Name	profile acceleration, MT.ACC (DRV.ACC in Profile Velocity Mode)
Object code	VAR
Data type	UNSIGNED32
Mode	pp, pv
Access	R/W
PDO mapping	possible
Unit	acceleration units
Value range	0 to $(2^{32}-1)$
Default value	0

21.3.67 Object 6084h: Profile deceleration (DS402)

The braking/deceleration ramp is handled in the same way as the acceleration ramp (" Object 6083h: Profile acceleration (DS402)" (→ p. 1033)).

Index	6084h
Name	profile deceleration, MT.DEC (DRV.DEC in Profile Velocity Mode)
Object code	VAR
Data type	UNSIGNED32
Mode	pp, pv
Access	R/W
PDO mapping	possible

Unit	deceleration units
Value range	0 to $(2^{32}-1)$
Default value	0

21.3.68 Object 608Fh: Position encoder resolution (DS402)

The position encoder resolution defines the ratio of encoder increments per motor revolution on the CANopen end. Encoder increments are set either directly by subindex 1 (only powers of 2 available) or implicit by writing to the parameter FB1.PSCALE.

Index	608Fh
Name	Position encoder resolution
Object Code	ARRAY
Data Type	UNSIGNED 32
Category	optional
Subindex	0
Name	highest sub-index supported
Data type	UNSIGNED8
Category	mandatory
Access	R/O
PDO Mapping	not possible
Value Range	2
Default Value	2
Subindex	1
Name	Encoder increments
Category	mandatory
Access	R/W
PDO Mapping	not possible
Value Range	UNSIGNED 32
Default Value	2 ²⁰
Subindex	2
Name	Motor revolutions
Category	mandatory
Access	R/W
PDO Mapping	not possible
Value Range	UNSIGNED 32
Default Value	1

21.3.69 Object 6091h: Gear Ratio (DS402)

The gear ratio defines the ratio of feed in position units per driving shaft revolutions. This includes the gear if present.

gear ratio = motor shaft revolutions / driving shaft revolutions

Index	6091h
Name	Gear Ratio
Object Code	ARRAY
Data Type	UNSIGNED 32
Category	optional
Subindex	0
Name	highest sub-index supported
Data type	UNSIGNED8
Category	mandatory
Access	R/O
PDO Mapping	not possible
Value Range	2
Default Value	2
Subindex	1
Name	Motor revolution
Category	mandatory
Access	R/W
PDO Mapping	not possible
Value Range	UNSIGNED 32
Default Value	1
Subindex	2
Name	Shaft revolutions
Category	mandatory
Access	R/W
PDO Mapping	not possible
Value Range	UNSIGNED 32
Default Value	1

21.3.70 Object 6092h: Feed constant (DS402)

The feed constant defines the ratio of feed in position units per driving shaft revolutions. This includes the gear if present.

Index	6092h
Name	Feed constant
Object Code	ARRAY
Data Type	UNSIGNED 32
Category	optional
Subindex	0
Name	highest sub-index supported
Data type	UNSIGNED8
Category	mandatory
Access	R/O
PDO Mapping	not possible
Value Range	2
Default Value	2
Subindex	1
Name	Feed
Category	mandatory
Access	R/W
PDO Mapping	not possible
Value Range	UNSIGNED 32
Default Value	1
Subindex	2
Name	Shaft revolutions
Category	mandatory
Access	R/W
PDO Mapping	not possible
Value Range	UNSIGNED 32
Default Value	1

21.3.71 Object 6098h: Homing method (DS402)

Index	6098h
Name	homing method, HOME.MODE, HOME.DIR
Object code	VAR
Data type	INTEGER8
Mode	hm
Access	R/W
PDO mapping	not possible
Unit	position units
Value range	-128 to 127
Default value	0

Description of the homing methods

Choosing a homing method by writing a value to homing method (Object 6098h) will clearly establish:

- the homing signal (P-Stop, N-Stop, reference switch)
- the direction of actuation

and where appropriate

- the position of the index pulse.

The reference position is give by the reference offset (Object 607Ch).

A detailed description of the types of homing movement can be found in the description of [EWW¹](#).

The following homing methods are supported:

Method as per DS402	Brief description: Homing	command
-128 to -5	reserved	—
-4	find reference switch with fast velocity (6099h sub1) and home on reference switch with low velocity (6099h sub 2), positive count direction	HOME.MODE=16, HOME.DIR=0
-3	find reference switch with fast velocity (6099h sub 1) and home on reference switch with low velocity (6099h sub 2), negative count direction	HOME.MODE=16, HOME.DIR=0
-2 to -1	reserved	—
0	reserved	—
1	homing to negative limit switch, with zeroing, negative count direction	HOME.MODE=2, HOME.DIR=0
2	homing to positive limit switch, with zeroing, positive count direction	HOME.MODE=2, HOME.DIR=1
3 to 7	not supported	—
8	homing to reference switch, with zeroing, positive count direction	HOME.MODE=5, HOME.DIR=1
9 to 11	not supported	—

¹Embedded Workbench Views

Method as per DS402	Brief description: Homing	command
12	homing to reference switch, with zeroing, negative count direction	HOME.MODE=5, HOME.DIR=0
13 to 14	not supported	—
15 to 16	reserved	—
17	homing to negative limit switch, without zeroing, negative count direction	HOME.MODE=1, HOME.DIR=0
18	homing to negative limit switch, without zeroing, positive count direction	HOME.MODE=1, HOME.DIR=1
19 to 23	not supported	—
24	homing to reference switch, without zeroing, positive count direction	HOME.MODE=4, HOME.DIR=1
25 to 27	not supported	—
28	homing to reference switch, without zeroing, negative count direction	HOME.MODE=4, HOME.DIR=0
29 to 30	not supported	—
31 to 32	reserved	—
33	homing within a single turn, negative count direction. If the feedback has an index pulse, HOME.MODE 11 will be used.	HOME.MODE=7,11 HOME.DIR=0
34	homing within a single turn, positive count direction. If the feedback has an index pulse, HOME.MODE 11 will be used.	HOME.MODE=7,11 HOME.DIR=1
35	set reference point at present position	HOME.MODE=0, HOME.DIR=0
36 to 127	reserved	—

21.3.72 Object 6099h: Homing speeds (DS402)

Index	6099h
Name	homing speeds
Object code	ARRAY
Data type	UNSIGNED32
Subindex	1
Description	speed during search for switch, HOME.V
Mode	hm
Access	R/W
PDO mapping	not possible
Unit	velocity units
Value range	0 to $(2^{32}-1)$
Default value	equivalent 60 rpm
Subindex	2

Description	speed during search for zero, HOME.FEEDRATE
Mode	hm
Access	R/W
PDO mapping	not possible
Unit	velocity units
Value range	0 to $(2^{32}-1)$
Default value	1/8 * Object 6099 sub 1

21.3.73 Object 609Ah: Homing acceleration (DS402)

Index	609Ah
Name	homing acceleration
Object code	VAR
Data type	UNSIGNED32
Mode	hm
Access	R/W
PDO mapping	not possible
Unit	acceleration units
Value range	0 to $(2^{32}-1)$
Default value	0

21.3.74 Object 60B1h: Velocity Offset

This object provides the offset of the velocity value in cyclic synchronous position mode. It is scaled via the object 204Ch.

Index	60B1h
Name	Velocity Offset
Object code	VAR
Data type	INTEGER32
Category	optional
Access	R/W
PDO mapping	possible
Value range	INTEGER32
Default value	0

21.3.75 Object 60B2h: Torque Offset

This object provides the offset of the commanded torque value in cyclic synchronous position mode. Scaling is 1/1000 of rated torque.

Index	60B2h
Name	Torque Offset
Object code	VAR
Data type	INTEGER16
Category	optional
Access	R/O
PDO mapping	possible
Value range	INTEGER16
Default value	0

21.3.76 Object 60B8h: Touch probe function

This object indicates the configured function of the touch probe.

Index	60B8h
Name	Touch probe function
Object code	Variable
Data type	UNSIGNED16
Category	optional
Access	R/W
PDO Mapping	yes
Value range	UNSIGNED16
Default value	0

Definition of the possible functions:

Bit	Value	Meaning
0	0	Switch off touch probe 1
	1	Enable touch probe 1
1	0	Trigger first event
	1	Continuous
3, 2	00b*	Trigger with touch probe 1 input
	01b	Trigger with zero impulse signal or position encoder
	10b	Touch probe source as defined in object 60D0h, sub-index 01h
	11b	reserved
4	0	Switch off sampling at positive edge of touch probe 1
	1	Enable sampling at positive edge of touch probe 1
5	0	Switch off sampling at negative edge of touch probe 1
	1	Enable sampling at negative edge of touch probe 1
6, 7	-	User-defined (e.g. for testing)
8	0	Switch off touch probe 2
	1	Enable touch probe 2
9	0	Trigger first event
	1	continuous
11, 10	00b	Trigger with touch probe 2 input
	01b	Trigger with zero impulse signal or position encoder
	10b	Touch probe source as defined in object 60D0h, sub-index 02h
	11b	reserved
12	0	Switch off sampling at positive edge of touch probe 2
	1	Enable sampling at positive edge of touch probe 2
13	0	Switch off sampling at negative edge of touch probe 2
	1	Enable sampling at negative edge of touch probe 2
14, 15	-	User-defined (e.g. for testing)

* b = binary

If both edges are selected at the same time (bit 4=1 and bit 5=1 for probe 1 or bit 12=1 and bit 13=1 for probe 2), the first edge (positive or negative) triggers the probe function. The position, latched at this edge, is taken over for both edges (positive and negative).

21.3.77 Object 60B9h: Touch probe status

This object indicates the status of the touch probe.

Index	60B9h
Name	Touch probe status
Object code	Variable
Data type	UNSIGNED16
Category	optional
Access	R/O
PDO Mapping	yes
Value range	UNSIGNED16
Default value	0

Definition of the status:

Bit	Value	Meaning
0	0	Touch probe 1 is switched off
	1	Touch probe 1 is enabled
1	0	Touch probe 1 no positive edge value stored
	1	Touch probe 1 positive edge position stored
2	0	Touch probe 1 no negative edge value stored
	1	Touch probe 1 negative edge position stored
3 to 5	0	reserved
6, 7	-	User-defined (e.g. for testing)
8	0	Touch probe 2 is switched off
	1	Touch probe 2 is enabled
9	0	Touch probe 2 no positive edge value stored
	1	Touch probe 2 positive edge position stored
10	0	Touch probe 2 no negative edge value stored
	1	Touch probe2 negative edge position stored
11 to 13	0	reserved
14, 15	-	User-defined (e.g. for testing)

21.3.78 Object 60BAh: Touch probe 1 positive edge

This object provides the position value of the touch probe 1 at positive edge.

Index	60BAh
Name	Touch probe 1 positive edge
Object code	Variable
Data type	INTEGER32
Category	optional
Access	R/O
PDO Mapping	yes
Value range	INTEGER32
Default value	no

21.3.79 Object 60BBh: Touch probe 1 negative edge

This object provides the position value of the touch probe 1 at negative edge.

Index	60BBh
Name	Touch probe 1 negative edge
Object code	Variable
Data type	INTEGER32
Category	optional
Access	R/O
PDO Mapping	yes
Value range	INTEGER32
Default value	no

21.3.80 Object 60BCh: Touch probe 2 positive edge

This object provides the position value of the touch probe 2 at positive edge.

Index	60BCh
Name	Touch probe 2 positive edge
Object code	Variable
Data type	INTEGER32
Category	optional
Access	R/O
PDO Mapping	yes
Value range	INTEGER32
Default value	no

21.3.81 Object 60BDh: Touch probe 2 negative edge

This object provides the position value of the touch probe 2 at negative edge.

Index	60BDh
Name	Touch probe 2 negative edge
Object code	Variable
Data type	INTEGER32
Category	optional
Access	R/O
PDO Mapping	yes
Value range	INTEGER32
Default value	no

21.3.82 Object 60C0h: Interpolation sub mode select

In the AKD PDMM, linear interpolation between position setpoints is supported.

Index	60C0h
Name	Interpolation sub mode select
Object code	VAR
Data type	INTEGER16
Category	optional
Access	R/W
PDO mapping	not possible
Value range	0
Default value	0

Value description

Value(decimal)	Description
0	Linear interpolation with a constant time.

21.3.83 Object 60C1h: Interpolation data record

In the AKD PDMM, a single setpoint (target position, Subindex 1) is supported for the linear interpolation. After the last item of an interpolation data record is written to the devices input buffer, the buffer pointer is automatically incremented to the next buffer.

Index	60C1h
Name	Interpolation data record
Object code	ARRAY
Data type	INTEGER32
Category	optional
Subindex	0
Description	highest sub-index supported
Data type	UNSIGNED8
Category	mandatory
Access	R/O
PDO mapping	not possible
Value range	1
Default value	1
Subindex	1
Description	Interpolation target position in counts, the first parameter of interpolation function
Category	mandatory
Access	R/W
PDO mapping	possible
Value range	INTEGER32
Default value	no

NOTE

A set-point value of the Interpolation data record is only taken, if beside the state machine state "Operation Enable" also the bit 4 of the DS402 controlword (Enable Interpolation, see "Object 6040h: Control word (DS402)" (→ p. 1023)) is set.

21.3.84 Object 60C2h: Interpolation time period

The interpolation time period is used for the PLL (phase locked loop) synchronized position modes. The unit (subindex 1) of the time is given in $10^{\text{interpolation time index}}$ seconds.

Only multiples of 1 ms are allowed. The two values define the internal AKD PDMM parameter FBUS.SAMPLEPERIOD (given in multiples of 62.5 Mikroseconds). Both values must be written to set a new interpolation time period. FBUS.SAMPLEPERIOD will only be updated then.

Index	60C2h
Name	Interpolation time period
Object code	RECORD
Data type	Interpolation time period record (0080h)
Category	optional
Subindex	0
Description	highest sub-index supported, FBUS.SAMPLEPERIOD
Category	mandatory
Access	R/O
PDO mapping	not possible
Value range	2
Default value	2
Subindex	1
Description	Interpolation time units
Category	mandatory
Access	R/W
PDO mapping	not possible
Value range	UNSIGNED8
Default value	2
Subindex	2
Description	Interpolation time index
Category	mandatory
Access	R/W
PDO mapping	not possible
Value range	INTEGER8
Default value	-3

21.3.85 Object 60C4h: Interpolation data configuration

In the AKD PDMM, for linear interpolation, only the value 1 in Subindex 5 is possible. For cubic interpolation, Subindex 1 and Subindex 2 is possible for manage the buffer of cubic interpolation.

Index	60C4h
Name	Interpolation data configuration
Object code	RECORD
Data type	Interpolation data configuration record (0081h)
Category	optional
Subindex	0
Description	highest sub-index supported
Category	mandatory
Access	R/O
PDO mapping	not possible
Value range	6
Default value	6
Subindex	1
Description	Maximum buffer size
Category	mandatory
Access	R/O
PDO mapping	not possible
Value range	UNSIGNED32
Default value	10
Subindex	2
Description	Actual buffer size
Category	mandatory
Access	R/O
PDO mapping	possible
Value range	0 to 9
Default value	9
Subindex	3
Description	Buffer organization
Category	mandatory
Access	R/W
PDO mapping	not possible
Value range	UNSIGND8
Default value	0

Subindex	4
Description	Buffer position
Category	mandatory
Access	R/W
PDO mapping	not possible
Value range	UNSIGNED16
Default value	0
Subindex	5
Description	Size of data record
Category	mandatory
Access	W
PDO mapping	not possible
Value range	1 to 254
Default value	1
Subindex	6
Description	Buffer clear
Category	mandatory
Access	W
PDO mapping	not possible
Value range	UNSIGNED8
Default value	0

21.3.86 Object 60D0h: Touch probe source

This object provides the source of the touch probe function, when the dedicated bits 2/3 or 10/11 of the touch probe function (object 60B8h) are set accordingly.

Index	60D0h
Name	Touch probe source
Object code	Array
Data type	Integer 16
Category	optional
Subindex	0
Description	Highest sub-index supported
Category	mandatory
Access	R/O
PDO mapping	not possible
Value range	2
Default value	2
Subindex	1
Description	Touch probe 1 source
Category	mandatory
Access	R/W
PDO mapping	not possible
Value range	-11 to -1, 1 to 5
Default value	1
Subindex	2
Description	Touch probe 2 source
Category	mandatory
Access	R/W
PDO mapping	not possible
Value range	-11 to -1, 1 to 5
Default value	1

Value description:

Value	Description	Value	Description
1	Touch Probe 1 Input	3	Touch Probe 3 Input
2	Touch Probe 2 Input	4	Touch Probe 4 Input
-1 to -11	AKD PDMM Input related to CAPx.TRIGGER 0 to 10		

21.3.87 Object 60E0h: Positive Torque Limit Value

The object gives the configured maximum motor torque in positive direction. The value is given per thousand (1 ‰) of rated torque.

Index	60E0h
Name	Positive Torque Limit Value
Object code	Variable
Data type	UIINTEGER16
Category	optional
Access	R/O
PDO Mapping	yes
Value range	UIINTEGER16 (limited by DRV.IPEAK and MOTOR.IPEAK)
Default value	0

21.3.88 Object 60E1h: Negative Torque Limit Value

The object gives the configured maximum motor torque in negative direction. The value is given per thousand (1 ‰) of rated torque.

Index	60E1h
Name	Negative Torque Limit Value
Object code	Variable
Data type	UIINTEGER16
Category	optional
Access	R/O
PDO Mapping	yes
Value range	UIINTEGER16 (limited by DRV.IPEAK and MOTOR.IPEAK)
Default value	0

21.3.89 Object 60E4h: Additional position actual value

This object provides the additional position actual values. The values are given in user-defined position units. The value is calculated analog to the calculation for the actual position 6064h via object 6091h and 6092h, but for this with the factors given by the objects 60E8h, 60E9h, 60EDh and 60EEh.

Index	60E4h
Name	Additional position actual value
Object code	ARRAY
Data type	INTEGER32
Category	optional
Subindex	0
Description	highest sub-index supported
Category	mandatory
Access	R/O
PDO mapping	not possible
Value range	3
Default value	3
Subindex	1
Description	1st additional position actual value
Category	mandatory
Access	R/W
PDO mapping	not possible
Value range	INTEGER32
Default value	1
Subindex	2
Description	reserved
Category	
Access	
PDO mapping	
Value range	
Default value	
Subindex	3
Description	3rd additional position actual value
Category	optional
Access	R/W
PDO mapping	not possible
Value range	INTEGER32
Default value	0

21.3.90 Object 60E8h: Additional gear ratio – motor shaft revolutions

This object provides the motor shaft revolutions for the additional gear ratio calculation. This object shall be used with the corresponding subindex of the object 60EDh (driving shaft revolutions for the additional gear ratio calculation). The value of the object 60E4h is calculated analog to the gear ration calculation for the actual position 6064h via object 6091h.

Index	60E8h
Name	Additional gear ratio – motor shaft revolutions
Object code	ARRAY
Data type	UNSIGNED32
Category	optional
Subindex	0
Description	highest sub-index supported
Category	mandatory
Access	R/O
PDO mapping	not possible
Value range	3
Default value	3
Subindex	1
Description	1st additional gear ratio - motor shaft
Category	mandatory
Access	R/W
PDO mapping	not possible
Value range	UNSIGNED32
Default value	1
Subindex	2
Description	reserved
Category	
Access	
PDO mapping	
Value range	
Default value	
Subindex	3
Description	3rd additional gear ratio - motor shaft
Category	optional
Access	R/W
PDO mapping	not possible
Value range	UNSIGNED32
Default value	1

21.3.91 Object 60E9h: Additional feed constant – feed

This object provides the feed for the additional feed constant calculation. This object shall be used with the corresponding subindex of the object 60EEh (driving shaft revolutions for the additional feed constant calculation). The value of the object 60E4h is calculated analog to the feed constant calculation for the actual position 6064h via object 6092h.

Index	60E9h
Name	Additional feed constant – feed
Object code	ARRAY
Data type	UNSIGNED32
Category	optional
Subindex	0
Description	highest sub-index supported
Category	mandatory
Access	R/O
PDO mapping	not possible
Value range	3
Default value	3
Subindex	1
Description	1st additional feed constant – feed
Category	mandatory
Access	R/W
PDO mapping	not possible
Value range	UNSIGNED32
Default value	1
Subindex	2
Description	reserved
Category	
Access	
PDO mapping	
Value range	
Default value	
Subindex	3
Description	3rd additional feed constant – feed
Category	optional
Access	R/W
PDO mapping	not possible
Value range	UNSIGNED32
Default value	1

21.3.92 Object 60EDh: Additional gear ratio – driving shaft revolutions

This object provides the driving shaft revolutions for the additional gear ratio calculation. This object shall be used with the corresponding subindex of the object 60E8h (motor shaft revolutions for the additional gear ratio calculation). The value of the object 60E4h is calculated analog to the gear ration calculation for the actual position 6064h via object 6091h.

Index	60EDh
Name	Additional gear ratio – driving shaft revolutions
Object code	ARRAY
Data type	UNSIGNED32
Category	optional
Subindex	0
Description	highest sub-index supported
Category	mandatory
Access	R/O
PDO mapping	not possible
Value range	3
Default value	3
Subindex	1
Description	1st additional gear ratio - driving shaft
Category	mandatory
Access	R/W
PDO mapping	not possible
Value range	UNSIGNED32
Default value	1
Subindex	2
Description	reserved
Category	
Access	
PDO mapping	
Value range	
Default value	
Subindex	3
Description	3rd additional gear ratio - driving shaft
Category	optional
Access	R/W
PDO mapping	not possible
Value range	UNSIGNED32
Default value	1

21.3.93 Object 60EEh: Additional feed constant - driving shaft revolutions

This object provides the driving shaft revolutions for the additional feed constant calculation. This object shall be used with the corresponding subindex of the object 60E9h (feed for the additional feed constant calculation). The value of the object 60E4h is calculated analog to the feed constant calculation for the actual position 6064h via object 6092h.

Index	60EEh
Name	Additional feed constant - driving shaft revolutions
Object code	ARRAY
Data type	UNSIGNED32
Category	optional
Subindex	0
Description	highest sub-index supported
Category	mandatory
Access	R/O
PDO mapping	not possible
Value range	3
Default value	3
Subindex	1
Description	1st additional feed constant – driving shaft revolutions
Category	mandatory
Access	R/W
PDO mapping	not possible
Value range	UNSIGNED32
Default value	1
Subindex	2
Description	reserved
Category	
Access	
PDO mapping	
Value range	
Default value	
Subindex	3
Description	3rd additional feed constant – driving shaft revolutions
Category	optional
Access	R/W
PDO mapping	not possible
Value range	UNSIGNED32
Default value	1

21.3.94 Object 60F4h: Following error actual value (DS402)

This object returns the current value of the following error in units defined by the user.

Index	60F4h
Name	Following error actual value
Object code	VAR
Data type	Integer32
Category	optional
Access	R/O
PDO mapping	possible
Value range	INTEGER32
Default value	0

21.3.95 Object 60FCh: Position demand internal value (DS402)

This object provides the output of the trajectory generator in position modes. The value is consistent in scaling to the actual internal position value (6063h) and the first setpoint in object 60C1h.

Index	60FCh
Name	Position demand internal value
Object code	VAR
Data type	INTEGER32
Category	optional
Access	R/O
PDO mapping	possible
Value range	INTEGER32
Default value	0

21.3.96 Object 60FDh: Digital inputs (DS402)

This index defines simple digital inputs for drives. The manufacturer bits 16 to 2216 to 18 display the actual state of the digital inputs 1 to 71 to 3 (DINx.STATE). The manufacturer bits 24 to 3024 to 26 latch a state change of the digital inputs 1 to 71 to 3. Bits 24 to 3024 to 26 can be reset with object "20B8h" (→ p. 1015).

Index	60FDh
Name	digital inputs
Object code	VAR
Data type	UNSIGNED32
Category	optional
Access	R/O
PDO mapping	possible
Value range	UNSIGNED32
Default value	0

31	16	15	4	3	2	1	0
manufacturer specific		reserved		enable	home switch	pos. limit switch	neg. limit switch
MSB							LSB

21.3.97 Object 60FEh: Digital outputs (DS402)

This index defines simple digital outputs for drives. The manufacturer bits 16 and 17 are bit 16 is show the actual status of the digital outputs 1 and 2 output 1.

Index	60FEh					
Name	digital outputs					
Object code	Array					
Data type	UNSIGNED32					
Category	optional					
Subindex	0					
Description	highest sub-index supported					
Category	mandatory					
Access	R/O					
PDO mapping	not possible					
Value range	2					
Default value	2					
Subindex	1					
Description	physical outputs					
Category	mandatory					
Access	R/W					
PDO mapping	possible					
Value range	UNSIGNED32					
Default value	0					
Subindex	2					
Description	bit mask					
Category	optional					
Access	R/W					
PDO mapping	not possible					
Value range	UNSIGNED32					
Default value	0					
31	18	17	16	15	1	0
manufacturer specific		DOUT2	DOUT1	reserved		set brake
MSB						LSB

21.3.98 Object 60FFh: Target velocity (DS402)

The speed setpoint (target velocity) represents the setpoint for the ramp generator.

Index	60FFh
Name	target velocity, VL.CMDU
Object code	VAR
Data type	INTEGER32
Mode	pv
Access	R/W
PDO mapping	possible
Unit	increments
Value range	(-2^{31}) to $(2^{31}-1)$
Default value	—
Float scaling	1000:1
EEPROM	no

21.3.99 Object 6502h: Supported drive modes (DS402)

A drive can support more than one and several distinct modes of operation. This object gives an overview of the implemented operating modes in the device. This object is read only.

Index	6502h
Name	supported drive modes
Object code	VAR
Data type	UNSIGNED32
Category	optional
Access	R/O
PDO mapping	not possible
Value range	UNSIGNED32
Default value	0xE5 (csp ip hm pv pp)

31	16	15	11	10	9	8	7	6	5	4	3	2	1	0
manufacturer specific	reserved	cstca	cst	csv	csp	ip	hm	reserved	tq	pv	vl	pp		
MSB														LSB

22 Glossary

Term	Description
60° & 120° Hall Sequences	A method for decoding logic signals produced by Hall effect sensors installed in an electronically-switched three-phase brushless motor.
Absolute Encoder	The optical disk of the absolute encoder is designed to produce a digital word that distinguishes N distinct positions of the shaft. For example, if there are 8 tracks, the encoder is capable of producing 256 distinct positions or an angular resolution of 1.406 (360/256) degrees.
Absolute Move	A positioning movement which is referenced to a fixed original position. For example, if a stage is positioned at +500 mm, an absolute move to +300 mm would result in a move of 200 mm towards the origin (in the negative direction).
Acceleration	A change in velocity over time. Because velocity is a vector , it can change in two ways: a change in magnitude and/or a change in direction. In one dimension, acceleration is the rate at which something speeds up or slows down. However, more generally, acceleration is a vector quantity expressing the change with time of the velocity both in magnitude and in direction.
Accuracy	Accuracy is the distance between the actual position of a mechanical system and the expected position. It is typically specified in microns or arcsec per given travel for a deviation of $\pm 3\sigma$ (sigma).
Actuator	Mechanical device for moving or controlling a mechanism or system. The actuator is usually a physical mechanism but it can also refer to an artificial agent/intelligent agent. In virtual instrumentation actuators and sensors are the hardware complements of virtual instruments. Computer programs of virtual instruments use actuators to act upon real world objects.
Almirant	Almirant is a read only type of screen offered to the end user to control Sinop.
AS Input	A safety feature in the drive to prevent servos from being restarted.
ASCII	Short for American Standard Code for Information Interchange. ASCII provides a one-to-one mapping between alphanumeric characters, and a digital one-byte word.
Astrolab	Astrolab is a Windows integrated design environment (IDE) containing all the tools and editors (based on the different IEC 61131 languages) that users need during the entire life cycle of the machine.
Auxiliary Encoder	Describes the feedback on the load to close the position loop in critical applications. See Encoder.
Backlash	The backlash is an error in positioning caused by the reversal of travel direction. It is caused by a clearance between the elements of the mechanical system. The backlash also affects the bidirectional repeatability. The backlash can be compensated by the position controller.
Bandwidth	In computer networking, bandwidth often refers to a data rate measured in bits/s, for example, network throughput. The reason for the connection of data rate with the term <i>bandwidth</i> is that the limit to the data rate of a physical communication link is related to its bandwidth in hertz.
Bandwidth	The frequency at which the small signal response of a servo system begins to drop off; stage performance is enhanced by increasing servo bandwidth, although structural resonances typically limit the achievable bandwidth.

Term	Description
Blackfin	Blackfin refers to a family of 16/32-bit microprocessors with built-in Digital Signal Processor (DSP) functionality, which is traditionally only accompanied by a small and power-efficient microcontroller. The result is a low-power, unified processor architecture that can run operating systems while simultaneously handling complex numeric tasks such as real time H.264 video encoding.
Brake Applied or Released	The two states of the braking system. A device for slowing or stopping the motion of a motor, or alternatively a device to restrain it from starting to move again.
Brushless servomotor	An "inside-out" DC motor, with a permanent magnet rotor, and electrical coils in the stator. Commutation of current in the windings is typically achieved via external switching transistors, and Hall-effect detectors. This avoids the limited life of brushes and their radiated EMI.
Busy/Free	AKD PDMM support only one connection at a time. If a connection is in use, then the drive is "busy." If the connection is not use, then the drive is "free."
CAM profiling	The position of a slave axis is mathematically linked to the position of a master axis. A good example of this would be in a system where two rotating drums turn at a given ratio to each other. A more advanced case of electronic gearing is electronic camming. With electronic camming, a slave axis follows a profile that is a function of the master position. This profile need not be linear, but it must be a mathematical function.
CANopen	CANopen is a communication protocol and device profile specification for embedded systems used in automation for fieldbuses working in real-time
Cantilevered load	Any load not symmetrically mounted on a stage. Such loads exert torque moments upon the ways, and the resulting deformations can degrade accuracy
Caret	The term caret is also sometimes used in graphical user interface terminology where it means a text insertion point indicator, frequently represented by a blinking vertical bar. In this context, it may be used interchangeably with the word cursor , although the latter term is often reserved for a mouse pointer
Casting	see Typecasting item
Closed loop positioning	The use of feedback devices (encoders, resolvers, interferometers, etc.) to allow a motor to position a user payload accurately.
CmdGain	Sets the command gain for the command input.
CmdOffset	Sets the command offset for the command input.
CmdSrc	Selects Analog, PWM, or Command variable for command.
Coefficient of friction	This is defined as the ratio of the force required to move a given load to the magnitude of that load. Typical values for ball and crossed roller slides are 0.001 to 0.005.
COM	COM is the original name of the serial port interface. It might not only refer to physical ports, but also to virtual ports, such as ports created by Bluetooth or USB-to-Serial adapters.
Contactors	A contactor is an electrically controlled switch (relay) used for switching a power circuit. A contactor is activated by a control input which is a lower voltage / current than that which the contactor is switching. Unlike a circuit breaker a contactor is not intended to interrupt a short circuit current.
Custom	Refers to user modified or defined material (such as custom units or custom settings)

Term	Description
DeviceNet	DeviceNet is a communication protocol (based on Controller Area Network) used in the automation industry to interconnect control devices for data exchange. Typical applications as listed: information exchange, safety devices, and large I/O control networks
Drive	In electrical engineering, a drive is an electronic device to provide power to a motor or servo.
Driver	In computing and electronics, a driver is a software component allowing higher-level computer programs to interact with a computer hardware device. A driver typically communicates with the device through the computer bus or communications subsystem to which the hardware is connected.
Eccentricity	The eccentricity is the distance between the centring diameter of the baseplate and the centring diameter of the rotor. It is not dependent on the position.
Encoders	Generates an output signal that is directly proportional to the movement of the motor shaft. This signal is fed into the control circuitry in order to control the shaft position and speed. See also Optical encoders. The most common types are: <ul style="list-style-type: none"> • Incremental/Serial encoders • Hall effect sensors • Resolvers • Tachometer Generators
Encoder Counts	Used after quadrature decode.
Encoder Lines	Used before quadrature decode.
Environment	Environment objects are global objects that exist before the execution of the script. Typically, they are global objects of Astrolab that can be accessed from the script.
EtherCAT	"Ethernet for Control Automation Technology" EtherCAT is an open high performance Ethernet-based fieldbus system. The development goal of EtherCAT was to apply Ethernet to automation applications which require short data update times (also called cycle times) with low communication jitter (for synchronization purposes) and low hardware costs.
Ethernet	Ethernet is a large, diverse family of frame-based computer networking technologies that operate at many speeds for local area networks (LANs).
EtherNet/IP	An open industrial application layer protocol for industrial automation applications. The EtherNet/IP application layer protocol is based on the CIP layer.
Fast Input	The inputs are taken into account at each cycle depending on the system periodicity (for instance each Millisecond). Under certain circumstances this can be insufficient when we need more accuracy or if a quick respond from the system is required. To fill in the gap, a drive may have some fast input connections (generally one or two). When an event happens that triggers a Fast Input (e.g. when a sensor sends a rising edge), the detection of a signal occurs faster (which can be 1000-times more accurate than the system periodicity). Then the timestamp associated to this input can be provided to the IPC for taking the corrective actions.
Feedback Device	Some systems use a feedback device connected to the motor shaft or part of the driven mechanism to control the direction, acceleration and speed of the motor.

Term	Description
Fieldbus	A fieldbus is an industrial network system for real-time distributed control (e.g. CAN, Profibus, sercos [®] ...). It is one of the ways to connect Instruments in a plant design.
Flatness of travel	Deviation from ideal straight line travel in a vertical plane, also referred to as vertical runout.
Frame	In networking dialect, a message is called a frame.
Front-end	In software design, the front-end is the part of a software system that interacts directly with the user.
FW	Firmware.
G.p.i.b.	A standardized protocol, analogous to RS-232, for transmitting digital information. Unlike RS-232, the GPIB interface (also called IEEE-488) transmits data in parallel, not serial format (one byte at a time).
Half step	An extended 8-cycle current switching sequence for stepping motors that doubles resolution, reduces noise, and improves resonant conditions.
Hall-effect sensor	Highly accurate, non-contact limit switch which detects the proximity of a magnet and provides a digital output to assure an accurate position reference. Typical repeatability of the NEAT Hall sensor is $\pm 1-2$ microns.
Holding torque	Stepping motors, when energized, hold position via a magnetic field. The holding torque is the maximum torque which can be generated before the rotor slips to the next pole location (7.2 degrees for 200 step/revolution steppers).
Home switch	Any of a variety of sensors which can be used to establish an accurate initial position. This may consist of a standard end-of-travel Hall sensor; a center position opto-interrupter with half-travel blocking vane; an index signal on a linear encoder; a shaft coupling mounted magnet with Hall sensor; or a once-per-revolution encoder index signal. Once-per-revolution sensors will usually require a logical or-ing with a linear signal if a unique home position is required.
Homing	The homing procedure allows, based on a position measurement, to set a position offset to the motor in order to ensure it is physically at the home position.
Horizontal Straightness	The horizontal straightness is a horizontal deviation from the straight line of travel. A horizontal straightness deviation in the travel of the X-axis will cause a positioning error in the Y direction.
Hysteresis Error	The hysteresis error is a deviation between the actual and the commanded position caused by elastic forces accumulated in the motion system. It affects the accuracy and the bidirectional repeatability.
HW	Hardware
Incremental encoder (Relative encoder)	The incremental encoder, sometimes called a relative encoder, is simpler in design than the absolute encoder. It consists of two tracks and two sensors whose outputs are called channels A and B. As the shaft rotates, pulse trains occur on these channels at a frequency proportional to the shaft speed, and the phase relationship between the signals yields the direction of rotation.
Incremental move	Positioning mode in which moves are referenced from the previously held position.
Index	Zero pulse (zero signal) of a hardware pin such as digital input or feedback pin.
Index Pulse	A single generated by a second track on the encoder emitter disk that occurs once per revolution, which can be used to indicate an absolute position of the motor shaft. Encoder manufacturers identify the index pulse using different terms such as index, marker, home position and zero reference.

Term	Description
Inductance	The tendency of a motor coil to store energy in a magnetic field. High speed stepping motor performance is inversely proportional to motor inductance.
Internet socket	An Internet socket (or commonly, a network socket or socket), is an end-point of a bidirectional process-to-process communication flow across an IP based network, such as the Internet. Each socket is mapped to an application process or thread. A socket is an interface between an application process or thread and the TCP/IP protocol stack provided by the operating system. The plug type is generally RJ-45.
Interrupt	An interrupt is an asynchronous signal from hardware indicating the need for attention or a synchronous event in software indicating the need for a change to another execution stream.
Intime	INtime software combines deterministic, hard real-time control with standard Windows operating systems (including Windows XP, Windows XP Embedded, Windows 2000 and Windows Server 2003) without requiring additional hardware. Intime was designed specifically to take advantage of the powerful capabilities of the x86 processor architecture. Therefore, you're real-time and non real-time applications run in separate virtual machines on a single computer, for cost-effective, reliable control that is easy to develop and maintain.
Jerk	In physics, jerk, is the rate of change of acceleration; more precisely, the derivative of acceleration with respect to time
Lead error	The deviation of a leadscrew from its nominal pitch. The error is often monotonic (linear), although periodic error and thermal expansion set limits to its predictability.
Limit switch	A sensor, typically Hall-effect, optical, eddy current, or mechanical, which is used to sense the end of travel of a linear motion assembly. In addition to preventing overtravel, it is frequently used to establish a precision reference.
Mechanical angle	Mechanical angle of the feedback (always between 0°...360°)
Mechanical angle	Mechanical angle of the feedback, always between 0° and 360°.
Microstepping	A technique which, instead of switching phase currents in a stepping motor on and off, sinusoidally varies the current in the two windings. This effectively increases the resolution from 200 steps per revolution to 2,000 (~10) or 10,000 (~50) micro-steps per revolution.
Modbus	Modbus is a serial communications protocol and is now the most commonly available means of connecting industrial electronic devices. Modbus is often used to connect a supervisory computer with a remote terminal unit in supervisory control and data acquisition (SCADA) systems. Versions of the Modbus protocol exist for serial port and Ethernet (it is widely used with TCP/IP over Ethernet)
Motion control	Motion control is a sub-field of automation, in which the position and/or velocity of machines are controlled using some type of device such as a hydraulic pump, linear actuator, or an electric motor, generally a servo. Motion control is an important part of robotics and CNC machine tools, however it is more complex than in the use of specialized machines, where the kinematics are usually simpler. The latter is often called General Motion Control (GMC). Motion control is widely used in the packaging, printing, textile and assembly industries
Motor Continuous Stall Current	The amount of current applied to a motor when the rotor is locked and results in the rated temperature rise.

Term	Description
Motor Peak Current	Peak current or amps peak is the highest current that can flow through the motor or amps peak = 1.41 X amps/phase (or amps RMS).
Nonvolatile	Information is stored in a specific memory to remain accessible even when the application has been powered off. The memory type is called NV (Non-Volatile Memory) also NVS (Non Volatile Storage).
Nut stiffness	The stiffness of a leadscrew/nut assembly, typically measured in Newtons per meter (N/m). This stiffness, together with the moving mass and duplex bearing stiffness, sets the primary natural frequency of a leadscrew-driven stage.
Online/Offline	Active or connected/inactive or disconnected.
Open loop positioning	A positioning technique, typically utilizing stepping motors, in which the controller issues a sequence of commands to the motor without any absolute means of detecting if the move has in fact been made. When the load and move velocity and acceleration are appropriately defined, open loop positioning is capable of extended operation without losing steps.
OpenGL	OpenGL (Open Graphics Library) is a standard specification defining a cross-language cross-platform API for writing applications that produce 2D and 3D computer graphics. The Softscope uses this API to implement graphical manipulations.
Optical encoder	A linear or angular position feedback device, typically providing incremental two channel information in quadrature format (sine or square waves with a 90 degree phase shift between each channel). Such two channel information allows simple counter circuits to function as absolute position indicators.
Orthogonality	The degree of perpendicularity, or squareness, between the two axes in an X-Y or X-Z table. This parameter is usually measured in arc-seconds or micro radians.
P-code	a P-code machine or pseudo-code machine is a specification of a CPU (Central Processing Unit) whose instructions are expected to be executed in software rather than in hardware. Programs that have been translated to p-code are executed (interpreted) by a software program that emulates the behavior of the CPU specification.
Periodicity	Motor systems having a reciprocating or oscillating motor that operates synchronously with the periodicity of the source which supplies the electrical energy. The period of execution of a pipe is the time spent between two successive computations of set values for the same pipe. The period of execution of a pipe is specified by the PERIOD parameter of the input pipe block.
Phase current	The rated current which a stepping motor requires to generate its rated holding torque. This value is usually based on unipolar (half-coil) operation. This choice of how the motor is wired has significant impact on performance.
Phase sequence	The specific sequence of coil current changes used to advance a stepping motor clockwise and counter-clockwise, in either full or half step modes.

Term	Description
Pitch	<p>For lead-screws specified in British units, the number of full rotations required to advance the nut 1". For example, a 5 pitch lead-screw has a lead of 0.200". Metric screws are specified by lead only, in millimeters.</p> <p>The pitch is a rotation (angular deviation from the ideal straight line of travel) around an axis in the horizontal plane perpendicular to the direction of travel. For the X-axis travel, a pitch will cause an Abbé error in the X and Z directions</p> <p>An angular deviation possible in positioning systems, in which the table's leading edge rises or falls as the table translates along its direction of travel. This represents rotation around a horizontal axis, perpendicular to the direction of travel.</p>
PLCopen	A vendor -and product- independent worldwide association active in Industrial Control and aiming at standardizing PLC file formats based on XML
Position counts	AKD PDMM scales this so that the low 32 bits are the position per revolution (mechanical or electrical?).
Pragma	A compiler directive communicating additional "pragmatic" information.
Precedence	<p>In arithmetic and algebra, when a number or expression is both preceded and followed by a binary operation, a rule is required for which operation should be performed first. From the earliest use of mathematical notation, multiplication took precedence over addition, whichever side of a number it appeared on. Thus $3 + 4 \times 5 = 5 \times 4 + 3 = 23$.</p> <p>To change the order of operations, we use parentheses (). Thus, if we want to force addition to precede multiplication, we write $(3 + 4) \times 5 = 35$.</p>
Primary Encoder	Describes the feedback mounted onto the motor the drive is controlling. The Primary Encoder is used to force commutation. See also Encoder.
Probe	See Softscope - Probe item
PROFIBUS	<p>PROFIBUS (Process Fieldbus) is a standard for fieldbus communication in automation technology. PROFIBUS is the only fieldbus that can be used in equal measure in production automation and process automation and has since become a global market leader. Worldwide</p> <p>There are two variations of PROFIBUS; the most commonly used DP, and the lesser used PA variations:</p> <ul style="list-style-type: none"> • PROFIBUS DP (Decentralized Peripherals) is used to operate sensors and actuators via a centralized controller in production technology. The many standard diagnostic options, in particular, are focused on here. Other areas of use include the connection of "distributed intelligence", i.e. the networking of multiple controllers to one another (similar to PROFIBUS FMS). Data rates up to 12 Mbit/s on twisted pair cables and/or fiber optics are possible. • PROFIBUS PA (Process Automation) is used to monitor measuring equipment via a process control system in process engineering. This PROFIBUS variant is ideal for explosion-hazardous areas (Ex-zone 0 and 1). Here, a weak current flows through bus lines in an intrinsically safe circuit so that explosive sparks are not created, even if a malfunction occurs. The disadvantage of this variant is the slower data transmission rate of 31.25 kbit/s.
Programming	The act of performing a sequence of instructions or commands.
Quasi-closed loop positioning	A technique using a stepping motor and encoder in which open loop moves are completed, after which an encoder/counter is checked and, if necessary, a small final move or moves is used to achieve the desired accuracy.

Term	Description
Radial Run-out	The radial runout is the positioning error of a rotary table's centering diameter in the horizontal direction when the table is rotating in the horizontal plane.
Ramping	The gradual acceleration and deceleration of a stepping motor, essential if performance beyond the start/stop range is required. The slope of the ramp is a function of screw pitch, load, drive voltage and design, and motor.
Real-time computing	RTC is the study of hardware and software systems which are subject to a "real-time constraint" (i.e. operational deadlines from event to system response). By contrast, a non-real-time system is one for which there is no deadline, even if fast response or high performance is desired or even preferred. The needs of real-time software are often addressed in the context of real-time operating systems, and synchronous programming languages, which provide frameworks on which to build real-time application software. A real time system may be one where its application can be considered (within context) to be mission critical.
Reference Counting	In computer science, reference counting is a technique of storing the number of references, pointers, or handles to a resource such as an object or block of memory. It is typically used as a means of de-allocating objects which are no longer referenced.
Reference situation	Any situation that indicates that the home position has been found.
Reference switch	An adjustable hardware switch for indicating a home position.
Refresh	GUI command that re-loads the data from the drive and redraws the display.
Regen resistor	Regen Resistors are a necessity on all horizontal motion (bridge/trolley/monorail) applied Variable Speed drives. Power returns to the drive when the connected motor is driven in generator mode and is called regenerative power. This power is absorbed by charging the bus smoothing capacitor with the regen resistor consuming all that regenerative power exceeding the chargeable energy of the capacitor.
Relative encoder	See Incremental encoder.
Repeatability, bi-directional	The difference in absolute position reached when returning to a given position from the same direction. This value may mask significant amounts of backlash.
Repeatability, uni-directional	The difference in absolute position reached when returning to a given position from the opposing direction. This value is usually larger than the unidirectional repeatability.
Resolution	The resolution is the smallest possible movement that can be achieved by a system. It can be defined at the electronics, encoder and mechanics level. The distance a stage can be commanded to move in a single step. For servo systems, the basic increment produced by its optical encoder, or any other feedback device.
Resonance, midrange	A parasitic oscillation which is endemic to stepping motors, although frictional loads may mask its effect. It typically sets in from 5-15 revolutions per second, and can easily cause a loss of synchronization (stalling). All NEAT high speed micro-stepping drives effectively suppress this resonance.

Term	Description
Resonance, primary	The rotor inertia of a stepping motor, together with its spring-like holding torque, constitutes a basic spring-mass oscillator. In the absence of sufficient damping, stepping at certain frequencies may excite resonance in this system, or resonate with the stage or load, resulting in loss of synchrony. The addition of system damping, micro-stepping, or ramping through problematic speeds will usually eliminate this resonance.
Rising Edge	A rising edge is the transition of a digital signal from low to high. It is also named positive edge.
RJ-45	Internet plug type.
Roll	An angular deviation from an ideal straight line motion, in which the positioning table rotates around its axis of travel as it translates along that axis.
RS-232c	A popular protocol for transmitting digital data over two lines in a bit-serial format. RS-232C specifies signal levels, data formats, maximum transmission distance, etc.
Runtime	In computer science, runtime or run time describes the operation of a computer program, the duration of its execution, from beginning to termination (compare compile time).
Safe Torque Off	A safety feature in the drive to prevent servos from being restarted (STO).
Sensor	A sensor is a type of transducer that converts one type of energy to another for various purposes including measurement or information transfer.
sercos [®]	
Servo Drive	A servo drive is a special electric amplifier used to power electric servo motors. It monitors feedback signals from the motor and continually adjusts for deviation from expected behavior.
Servo Motor	A DC motor which produces a torque proportional to current. Precise positioning is achieved by linear or PWM (duty cycle) control of motor current or voltage, together with accurate monitoring of position via an external feedback device.
Setpoint	Setpoint is the target value that an automatic control system, for example PID controller, will aim to reach
Sinop	Sinop is a runtime engine issued from Astrolab and that provides a soft PLC and a motion controller via a graphical view of Axis movement with log messages
Softscope - Channel	A Channel is used by the softscope to acquire the evolution of a variable that is plugged into it
Softscope - Probe	A device that uses onboard instruments to gather and relay a variety of measurement to controllers from remote locations. Probes may return their data over radio links or be physically tethered to controllers or another device, or to collect and return physical samples
Softscope - Sampling	To acquire the variable's evolution, samples are taken at fixed intervals. The accuracy to create the trace depends on the resolution of the acquisition. The sampling frequency must be higher than 2 times the highest frequency in the input signal. This is called the Nyquist frequency. Theoretically it is possible to reconstruct the input signal with more than 2 samples per period. In practice, 10 to 20 samples per period are recommended to be able to examine the signal thoroughly
Softscope - Time base	The time base allows to set the speed at which all the lines for each channel are drawn, and is calibrated in milliseconds per division

Term	Description
Softscope - Trace	The trace is the resulting graph of a variable's evolution against time, with the more distant past on the left and the more recent past on the right
Stall speed	The maximum speed which a stepping motor, properly ramped, can achieve without loss of synchrony. This speed is a function of motor inductance, ramp slope, applied load, and drive voltage and design.
Start/stop speed	The maximum step rate which can be applied to a stationary stepping motor and still retain error-free performance. Also, the rate from which a stepping motor may be instantaneously stopped without overshooting. This is a function of the screw pitch, load, drive voltage and design, and motor.
Step rate	A type of motor featuring two or four stator coils and a toothed permanent magnet rotor, which moves through a small angle in response to a specific sequence of coil current changes.
Stepping motor	The frequency of coil current changes, or input pulse train, applied to a stepping motor, in pulses/second or hertz. For 200 step/revolution motors, the full step rate multiplied by 0.3 equals the rotation rate in R.P.M.
Straightness of travel	Deviation from straight line motion in a horizontal plane. Also referred to as horizontal runout. This error is usually traceable to an underlying angular error of the ways.
SynqNet	SynqNet is a digital machine control network. Built on the 100BT physical layer, SynqNet provides a synchronous real-time connection between motion controllers, servo drives, stepper drives, I/O modules, and custom devices
T.i.r.	This stands for Total Indicator Reading, which reflects the total absolute deviation from a mean value (versus a \pm value which indicates the deviation from a nominal value).
Thermal Expansion	The thermal expansion is a change of the size and shape of a system when the temperature is modified. The amount of change is dependent on the size of the component, the degree of temperature change and the characteristics of the material.
Timestamp	A timestamp is a sequence of characters, denoting the date and/or time at which a certain event occurred.
Torque	A radially directed force, typically measured in inch-ounces, foot-lbs. or Newton-meters.
Typecasting	In computer science, type conversion or typecasting refers to changing an entity of one data type into another. This is done to take advantage of certain features of type hierarchies. For instance, values from a more limited set, such as integers, can be stored in a more compact format and later converted to a different format enabling operations not previously possible, such as division with several decimal places' worth of accuracy. There are two types of conversion: implicit and explicit. The term for implicit type conversion is coercion. The most common form of explicit type conversion is known as casting. Explicit type conversion can also be achieved with separately defined conversion routines such as an overloaded object constructor.
Velocity	A vector quantity whose magnitude is a body's speed and whose direction is the body's direction of motion. Both speed and direction are required to define it and measured in meters/second (m/s).
Wibu	Developed by WIBU-SYSTEMS AG, WibuKey is the way to protect DMS software
Wobble	To move or rotate with an uneven or rocking motion or unsteadily from side to side.

Term	Description
Yaw	<p>The yaw is a rotation (angular deviation from the ideal straight line of travel) around the Z axis which is a vertical plane perpendicular to the direction of travel. For the X-axis travel, the yaw will cause an Abbé error in the X and Y directions.</p> <p>An angular deviation from ideal straight line motion, in which the positioning table rotates around the Z (vertical) axis as it translates along its travel axis.</p>
Zero angle	Mechanical zero angle of the feedback = 0 degree.

This page intentionally left blank.

23 Index

1

1000h	821, 975
1001h	822, 976
1002h	823, 977
1003h	824, 978
1005h	825, 979
1006h	825, 979
1008h	826, 980
1009h	826, 980
100Ah	826, 980
100Ch	827, 981
100Dh	827, 981
1010h	828, 982
1011h	829, 983
1012h	830, 984
1014h	830, 984
1016h	831, 985
1017h	832, 986
1018h	832, 986
1026h	834, 988
1400-1403h	835, 989
1600-1603h	836, 990
1800-1803h	838, 992
1A00-1A03h	841, 995
1C12h	842, 996
1C13h	843, 997

2

2000h	844, 998
2001h	844, 998
2002h	845, 999
2011h	846, 1000
2012h	847, 1001
2013h	848, 1002
2014-2017h	849, 1003
2018h	850, 1004
2026h	852, 1006
204Ch	853, 1007
2071h	854, 1008
2077h	854, 1008
20A0h	854, 1008
20A1h	856, 1010
20A2h	856, 1010
20A3h	857, 1011
20A4h	857, 1011
20A5h	858, 1013
20A6h	858, 1013
20A7h	860, 1015
20B8h	860, 1015

3

345Ah	861, 1016
3474h	864, 1019

3475h	865, 1020
3496h	866, 1021

6

6040h	868, 1023
6041h	869, 1024
6060h	872, 1027
6061h	873, 1028
6063h	873, 1028
6064h	873, 1028
6065h	874, 1029
606Ch	874, 1029
6071h	875, 1030
6073h	875, 1030
6077h	875, 1030
607Ah	876, 1031
607Ch	876, 1031
607Dh	877, 1032
6081h	878, 1033
6083h	878, 1033
6084h	878, 1033
608Fh	880, 1035
6091h	881, 1036
6092h	882, 1037
6098h	883, 1038
6099h	884, 1039
609Ah	886, 1041
60B1h	886, 1041
60B2h	886, 1041
60B8h	887, 1042
60B9h	889, 1044
60BAh	890, 1045
60BBh	890, 1045
60BCh	890, 1045
60BDh	891, 1046
60C0h	891, 1046
60C1h	892, 1047
60C2h	893, 1048
60C4h	894, 1049
60D0h	896, 1051
60E0h	897, 1052
60E1h	897, 1052
60E4h	898, 1053
60E8h	899, 1054
60E9h	900, 1055
60EDh	901, 1056
60EEh	902, 1057
60F4h	903, 1058
60FCh	904, 1059
60FDh	904, 1059
60FEh	905, 1060
60FFh	906, 1061
6502h	906, 1061

A

Acceleration ramp	354
AL Event	757, 911
Analog inputs	219

Analog setpoints	219
Anti-resonance filter	706
Aux. supply 24V, interface	206
B	
Basic drive setup	36
Blink	357
Brake view	64
C	
CANopen over EtherCAT	762, 916
Capture	65
Command source	362
Connection Diagrams	201
M variants	202
Control word	868, 1023
Control Word Commands	764, 918
Controlled Stop	81
Current loop gain scheduling	86
CW/CCW Input	223
Cycle Time	
Adjust	777, 931
Max.Values	777, 931
Cyclical Values	775, 929
D	
DC bus link, interface	211
deceleration	366
Direct DC mains	42
Disable	372
Dynamic Braking	83
E	
EEProm Content	789, 943
Emergency Messages	791, 945
Emergency Off	84
Emergency Stop Function	84
emergency timeout	375
Enable/Disable	78
Error Messages	
parameter and command	194
EtherCAT Profile	755, 909
F	
Fault messages	174
Faults	360
clearing	194
Feedback 1	56
Feedback Connection	224
Fieldbus	788, 942
Fieldbus Parameters	788, 942
Foldback	61

I

I/O-Connection	216
Inputs	
Analog	219
Interrupt Event	757, 911

L

Latch Words	780, 934
Limits	75

M

Macros	167
Mailbox	782, 936
Mains supply, interface	214
Motor	52
Motor interface	206
Motor Power Connection	206

N

Non-Plug and Play Feedback Devices	60
---	-----------

O

Object Dictionary	797, 951
Objects sorted	821, 975
Operating mode	872, 1027
parameters and commands active in	244
Operation Modes	777, 931
Outputs	
Analog	218

P

Parameter Load/Save	172
PDO Fixed Mapping	767, 921
PDO Flexible Mapping	769, 923
Performance Servo Tuner	106
advanced	110
Phase run-up	759, 913
Power	42
Pulse Direction, interface	222

R

Regen resistor, interface	208
Regeneration	44
Response monitoring	827, 981

S

scope	153
channels	153
settings and presets	162
time-base	153
Service Motion	91
Settings	39

Slave Register	756, 910
Slider Tuning	105
State Machine	762, 916
Status word	869, 1024
Status Word	766, 920
Stop Function	84
Synchronization	779, 933

T

Terminal	166
Trouble Shooting	199
Tuning	135

W

Warnings	174
Wizard	37

About KOLLMORGEN

Kollmorgen is a leading provider of motion systems and components for machine builders. Through world-class knowledge in motion, industry-leading quality and deep expertise in linking and integrating standard and custom products, Kollmorgen delivers breakthrough solutions that are unmatched in performance, reliability and ease-of-use, giving machine builders an irrefutable marketplace advantage.



Join the [Kollmorgen Developer Network](#) for product support. Ask the community questions, search the knowledge base for answers, get downloads, and suggest improvements.

North America KOLLMORGEN

203A West Rock Road
Radford, VA 24141
USA

Web: www.kollmorgen.com

Mail: support@kollmorgen.com

Tel.: +1 - 540 - 633 - 3545

Fax: +1 - 540 - 639 - 4162

Europe KOLLMORGEN Europe GmbH

Pempelfurtstraße 1
40880 Ratingen
Germany

Web: www.kollmorgen.com

Mail: technik@kollmorgen.com

Tel.: +49 - 2102 - 9394 - 0

Fax: +49 - 2102 - 9394 - 3155

China and SEA KOLLMORGEN

Room 202, Building 3, Lane 168,
Lin Hong Road, Changning District
Shanghai

Web: www.kollmorgen.cn

Mail: sales.china@kollmorgen.com

Tel.: +86 - 400 661 2802

Fax: +86 - 21 6128 9877

KOLLMORGEN®

Because Motion Matters™