

Synchronous Servomotors

Series 6SM27..107



Already published editions

Edition	Comments
03 / 98	First edition
09 / 98	Motor 6SM 37 VL-6000 added
08 / 99	Layout changed
04 / 2000	Motor 6SM 27 LL-4500 added, enhanced torque characteristics, further options
03 / 2001	Encoder wiring
12 / 2001	Dimensions of encoder-motors added
10 / 2005	Manufacturer declaration updated, front page design

**Technical changes to improve the performance of the equipment
may be made without prior notice!**

Printed in the Federal Republic of Germany 10/05

All rights reserved. No part of this work may be reproduced in any form (by printing, photocopying, microfilm or any other method) or stored, processed, copied or distributed by electronic means without the written permission of Danaher Motion Corporation.





Contents

I	General	
I.1	About this manual	7
I.2	Use as directed	7
I.3	Design of the motors	8
I.4	General technical data	8
I.5	Standard features	9
I.5.1	Style	9
I.5.2	Shaft end, A-side	9
I.5.3	Flange	9
I.5.4	Protection class	9
I.5.5	Protective device	9
I.5.6	Insulation material class	10
I.5.7	Vibration class	10
I.5.8	Connection method	10
I.5.9	Feedback unit	10
I.5.10	Holding brake	10
I.6	Options	11
I.7	Selection criteria	11
I.8	Technical data	12
I.8.1	Definitions	12
I.8.2	Technical data 6SM27..107	13
II	Installation / Commissioning	
II.1	Important notes	15
II.2	Assembly / Wiring	16
II.2.1	Connection methods	18
II.3	Commissioning	19
III	Drawings	
III.1	Dimensions 6SM27..107 with resolver	21
III.2	Dimensions 6SM27..107 with encoder	22
III.3	Radial-/axial force at the shaft end	22
III.4	Wiring diagram 6SM27..107 with resolver	23
III.5	Wiring diagram 6SM27..107 with encoder	24
III.6	Torque characteristics 6SM27M-4000	25
III.7	Torque characteristics 6SM27LL-4500	25
III.8	Torque characteristics 6SM37S-6000	26
III.9	Torque characteristics 6SM37M-6000	26
III.10	Torque characteristics 6SM37L-4000	27
III.11	Torque characteristics 6SM37VL-6000	27
III.12	Torque characteristics 6SM47L-3000	28
III.13	Torque characteristics 6SM57S-3000	28
III.14	Torque characteristics 6SM57M-3000	29
III.15	Torque characteristics 6SM77K-3000	29
III.16	Torque characteristics 6SM77S-3000	30
III.17	Torque characteristics 6SM107K-3000	30
III.18	Torque characteristics 6SM107S-3000	31
IV	Appendix	
IV.1	Delivery package, transport, storage, maintenance, disposal	33
IV.2	Fault-finding	34
IV.3	Index	35

Safety Notes

- Only properly qualified personnel are permitted to perform such tasks as transport, assembly, commissioning and maintenance. Properly qualified personnel are persons who are familiar with the transport, assembly, installation, commissioning and operation of motors, and who have the appropriate qualifications for their jobs. The qualified personnel must know and observe the following standards and regulations:
 IEC 364 resp. CENELEC HD 384 or DIN VDE 0100
 IEC-report 664 or DIN VDE 0110
 national regulations for safety and accident prevention or BGV A3
- Read the available documentation before assembly and commissioning. Incorrect handling of the motors can result in injury and damage to persons and machinery. Keep strictly to the technical data and the information on the connection requirements (nameplate and documentation).
- It is vital that you ensure that the motor housing is safely earthed to the PE(protective earth) busbar in the switch cabinet. Electrical safety is impossible without a low-resistance earth connection.
- Do not unplug any connectors during operation. This creates the danger of death, severe injury, or extensive material damage.
- Power connections may be live even when the motor is not rotating. Never disconnect the power connections of the motor while the equipment is energised. This can cause flashovers with resulting injuries to persons and damage to the contacts.
- After disconnecting the servo amplifier from the supply voltage, wait at least five minutes before touching any components which are normally live (e.g. contacts, screw connections) or opening any connections. The capacitors in the servo amplifier can still carry a dangerous voltage up to five minutes after switching off the supply voltages. To be quite safe, measure the DC-link voltage and wait until the voltage has fallen below 40V.
- The surfaces of the motors can be very hot in operation, according to their protection category. The surface temperature can reach 100°C. Measure the temperature, and wait until the motor has cooled down below 40°C before touching it.

Signs used in this manual

	Danger to personnel from electricity and its effects		General warning general instruction mechanical hazard
	see chapter (cross reference)		special emphasis

Important Notes

- Servomotors are precision equipment. The flange and shaft are especially vulnerable during storage and assembly — so avoid brute force. Precision requires delicacy. It is important to use the locking thread which is provided to tighten up couplings, gear wheels or pulley wheels and warm up the drive components, where possible. Blows or the use of force will lead to damage to the bearings and the shaft.

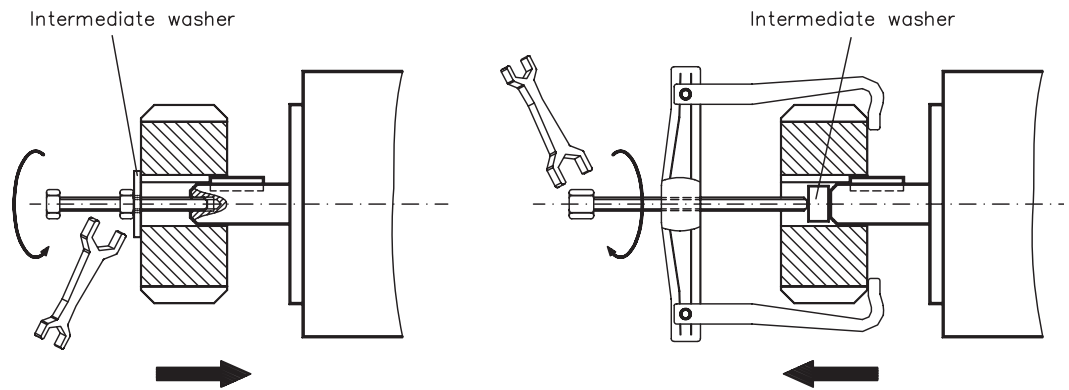

- Wherever possible, use only backlash-free, frictionally-locking collets or couplings. Ensure correct alignment of the couplings. A displacement will cause unacceptable vibration and the destruction of the bearings and the coupling.
- For toothed belts, it is vital to observe the permissible radial forces. An excessive radial load on the shaft will significantly shorten the life of the motor.
- Avoid axial loads on the motor shaft, as far as possible. Axial loading significantly shortens the life of the motor.
- In all cases, do not create a mechanically constrained motor shaft mounting by using a rigid coupling with additional external bearings (e.g. in a gearbox).
- For mounting style V3 (shaft end upwards), make sure that no liquid can enter the upper bearing.
- Take note of the no. of motor poles (6-pole) and the no. of resolver poles (2-pole), and ensure that the correct setting is made in the servo amplifier which is used. An incorrect setting can lead to the destruction of the motor, especially with small motors.

Manufacturer declaration

According to the EG-Machine-guideline 98/37/EWG, appendix II B

We, the company

Danaher Motion GmbH
 Wacholderstraße 40-42
 40489 Düsseldorf

declare, that the product

Motor series 6SM
(types 6SM27, 6SM37, 6SM47, 6SM57, 6SM77, 6SM107)

is intended exclusively, in its standard version, for installation in another machine and that its commissioning is forbidden until it has been established that the machine into which this product is to be installed conforms to the provisions of the EC Directive in its version 98/37/EEC.

We confirm that the above-mentioned product conforms to the following standards:

73/23/EWG	Low voltage directive
VDE 0530 / DIN 57530	Provisions for rotating machinery
DIN EN 60034-7	Design
DIN 748	Cylindrical shaft ends
DIN 42955	True running, coaxiality and concentricity
DIN EN 60034-14	Vibration class

Issued by: Management

Michel van Roozendaal

This Declaration does not contain any assurance of properties. The notes on safety and protection in the operating instructions must always be observed.

I General

I.1 About this manual

This manual describes the 6SM27..107 series of synchronous servomotors (standard version). Among other things, you find information about:

- Description of the Motors, Technical Data Chapter 1
- Installation, Commissioning of the motors Chapter 2
- Dimensions, wiring and characteristics Chapter 3
- Notes on Transport, Storage, Maintenance, Disposal Chapter 4



This manual is intended for the use of qualified staff with professional knowledge of electrical and mechanical engineering.

The motors are operated in drive systems together with servo amplifiers of the SERVOSTAR series. Please observe the entire system documentation, consisting of:

- Installation and commissioning instructions for the servo amplifier
- Installation and commissioning instructions for any built-in expansion card
- Operating manual for the Setup Software of the servo amplifier
- Technical description of the 6SM27..107 series of motors

I.2 Use as directed

The 6SM27..107 series of synchronous servomotors is designed especially for drives for industrial robots, machine tools, textile and packing machinery and similar with high requirements for dynamics.

The user is **only** permitted to operate the motors under the ambient conditions which are defined in this documentation.

The 6SM27..107 series of motors is **exclusively** intended to be driven by servo amplifiers from the SERVOSTAR series under speed and / or torque control.

The motors are installed as components in electrical apparatus or machines and can only be commissioned and put into operation as integral components of such apparatus or machines.

The motors must never be connected directly to the mains supply.

The thermal contact which is integrated in the motor windings must be observed and evaluated.

The conformity of the servo system to the standards mentioned in the manufacturers declaration on page 6 is only guaranteed when the components (servo amplifier, motor, cables etc.) that are used have been supplied by us.

I.3 Design of the motors

Synchronous servomotors in the 6SM27..107 series are brushless DC motors for demanding servo applications. When combined with our digital servo amplifiers they are especially suited for positioning tasks in industrial robots, machine tools, transfer lines etc. With high requirements for dynamics and stability.

The servomotors have permanent magnets in the rotor. The rare earth neodymium-iron-boron magnetic material is an important factor in making it possible to drive these motors in a highly dynamic fashion. A three-phase winding which is driven by the servo amplifier is integrated into the stator. The motor does not have any brushes since commutation is performed electronically by the servo amplifier.

The temperature of the winding is monitored by temperature sensors in the stator windings and is signalled via an electrically isolated contact (normally closed).

A **resolver** is built into the motors as standard feedback element. The servo amplifiers in the SERVOSTAR series evaluate the resolver (hence rotor) position and supply sinusoidal currents to the motors.

The motors can be delivered with or without a built-in holding brake. Retrofitting of the brake is not possible.

The motors are enamelled in matt black (RAL 9005). This finish is not resistant against solvents (e.g. trichlorethylene, nitro-thinners, or similar).

I.4 General technical data

Climate category	3K3 to EN 50178
Ambient temperature (at rated values)	5...+40°C for site altitude up to 1000m amsl It is vital to consult our applications department for ambient temperatures above 40°C and encapsulated mounting of the motors.
Permissible humidity (at rated values)	85% rel. humidity, no condensation
Power derating (currents and torques)	1% / K in range 40°C...50°C up to 1000m amsl for site altitude above 1000m amsl and 40°C 6% up to 2000m amsl 17% up to 3000m amsl 30% up to 4000m amsl 55% up to 5000m amsl No derating for site altitudes above 1000m amsl with temperature reduction of 10K / 1000m
Max. permissible flange temperature	65°C at rated values
Ball-bearing life	≥ 20.000 operating hours
Technical data	⇒I.8
Storage data	⇒IV.1

I.5 Standard features

I.5.1 Style

The basic style for the 6SM27..107 synchronous motors is style IM B5 according to DIN EN 60034-7. The permitted mounting positions may be read from the technical data of the motor series.

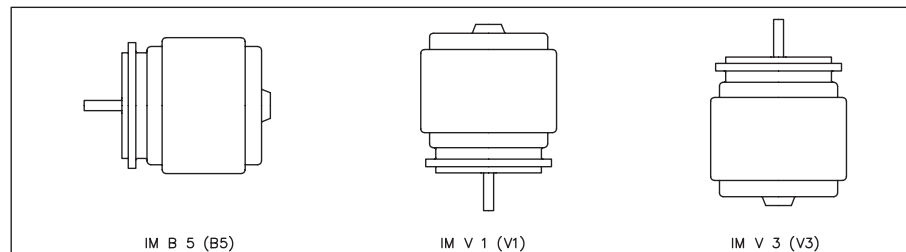

I.5.2 Shaft end, A-side

Power transmission is made through the cylindrical shaft end A (fit k6) to DIN 748, with a locking thread (except 6SM27) but **without a fitted-keyway**.

If the motors drive via pinions or toothed belts, then high radial forces will occur. The permissible values at the end of the shaft may be read from the diagram in chapter III.3. The maximum values at rated speed you will find at the technical data. Power take-off from the middle of the free end of the shaft allows a 10% increase in F_R .

The curves are based on a bearing life of 20.000 operating hours.

The axial force F_A must not exceed $F_R/3$.

If a brake is built-in the motor,

die axial force F_{ABR} must not exceed $F_R/10$.

Double-coned collets have proved to be ideal zero-backlash coupling devices, combined, if required, with metal bellows couplings.



I.5.3 Flange

Flange dimensions to IEC standard, fit j6, accuracy according to DIN 42955.
Tolerance class: **R**

I.5.4 Protection class

Standard version	IP65
Standard shaft bushing	IP64
Shaft bushing with shaft-sealing ring (Option -J-)	IP65

I.5.5 Protective device

The standard version of each motor is fitted with a thermostat (electrically isolated, normally closed). You will find the switching point at the technical data. The thermostat does **not** provide any protection against short, heavy overloading. Provided that our pre-assembled resolver cable is used, the thermostat contact is integrated into the monitoring system of the digital servo amplifier SERVOSTAR.

The flange temperature must not exceed 65°C in rated operation.



I.5.6 Insulation material class

The motors come up to insulation material class F according to DIN 57530.

I.5.7 Vibration class

The motors are made to vibration class N according to DIN EN 60034-14.

I.5.8 Connection method

The motors are fitted with rectangular connectors for power supply and resolver signals. The mating connectors are not part of the delivery package. We can supply preassembled resolver and power leads (⇒ II.2.1).

I.5.9 Feedback unit

The motors are equipped with two-pole hollow-shaft resolvers as standard. As an option, the motors are available with built in single- (ECNxx13) or multturn (EQNxx25) EnDat-encoders.

Type designation singleturn: 6SMxxx-xxxx-**S3-1313 (1113 at 6SM27)**

Type designation multturn: 6SMxxx-xxxx-**S3-1325 (1125 at 6SM27)**

The motor length changes when an encoder is mounted. Retrofitting is not possible.

I.5.10 Holding brake

The motors are optionally available with a holding brake.

Type designation: 6SMxxx-xxxx-**G**

A permanent magnet brake (24V DC) is integrated into the G-motors. When this brake is de-energized it blocks the rotor. **The holding brakes are designed as standstill brakes** and are not suited for repeated operational braking. If the brake is released then the rotor can be moved without a remanent torque, the operation is free from backlash! If a brake is built-in the motor, **die axial force F_{ABR} must not exceed $F_R/10$ (⇒ I.8.2)**.

The motor length increases when a holding brake is mounted.

The holding brake can be controlled directly by SERVOSTAR-servo amplifier (no personal safety !), the winding is suppressed in the servo amplifier — additional circuitry is not required.

If the holding brake is not controlled directly by the servo amplifier, an additional wiring (e.g. varistor) is required. Consult our applications department beforehand.

A personal safe operation of the holding brake requires an additional contact (normally opened) in the braking circuit and an anti-surge-device (e.g. Varistor) for the brake.

Wiring example for SERVOSTAR:

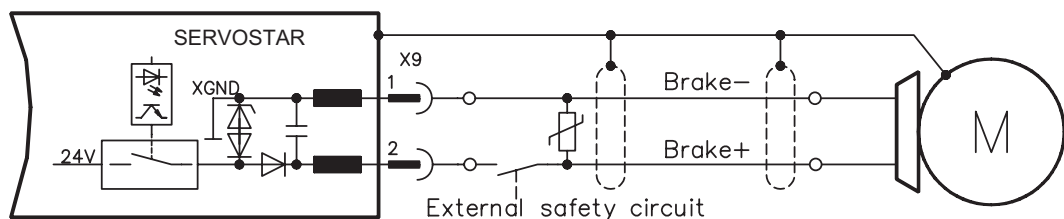

I.6 Options

- 09- Special flanges and shafts are possible, we invite inquiries.
- J- Radial shaft-sealing rings:
A radial shaft-sealing ring can be supplied at extra charge to seal against oil mist and oil spray. This increases the protection rating of the shaft bushing to IP65. The sealing ring is not suitable for dry running. When a holding brake is built in, the motor length increases by option -J- for 10mm.
- V- Vertical mounting sockets for resolver and power connections.
- C- Cable exit with PG-glands.
- K- Mounting flange for Stöber bevel gear
- 2K- Special varnish with 2-component enamel.
- 426- Encoder adaptor for ROD426/ROQ425 with coupling and eccentric washers.

I.7 Selection criteria

The three-phase servomotors are designed to operate with SERVOSTAR servo amplifiers. Together, both units form a closed speed or torque control loop.

The most important selection criteria are:

—	Standstill torque	M_0	[Nm]
—	Rated speed	n_n	[min⁻¹]
—	Moment of inertia of motor and load	J	[kgcm²]
—	Effective torque (calculated)	M_{rms}	[Nm]

When calculating the motors and servo amplifiers which are required, take account of the static load **and** the dynamic load (acceleration/braking). Collected formulae and examples of the calculations are available from our applications department.

I.8 Technical data

I.8.1 Definitions

Standstill torque M_0 [Nm]

The standstill torque can be maintained indefinitely at a speed $n=0 \text{ min}^{-1}$ and rated ambient conditions.

Rated torque M_n [Nm]

The rated torque is produced when the motor is drawing the rated current at the rated speed. The rated torque can be produced indefinitely at the rated speed in continuous operation (S1).

Standstill current I_{0rms} [A]

The standstill current is the effective sinusoidal current which the motor draws during standstill to produce the standstill torque.

Rated current I_{nrms} [A]

The rated current is the effective sinusoidal current which the motor draws at the rated speed in order to produce the rated torque.

Peak current (pulse current) I_{0max} [A]

The peak current (effective sinusoidal value) should not exceed 4-times the rated current. The actual value is determined by the peak current of the servo amplifier which is used.

Torque constant K_{Trms} [Nm/A]

The torque constant defines how much torque in Nm is produced by the motor with 1A r.m.s. current. The relationship is $M=I \times K_T$

Voltage constant K_{Erms} [V/1000min⁻¹]

The voltage constant defines the induced motor EMF, as an effective sinusoidal value between two terminals, per 1000 rpm

Rotor moment of inertia J [kgcm²]

The constant J is a measure of the acceleration capability of the motor. For instance, at I_0 the acceleration time t_b from 0 to 3000 rpm is given as:

$$t_b \text{ [s]} = \frac{3000 \times 2\pi}{M_0 \times 60s} \times \frac{m^2}{10^4 \text{ x cm}^2} \times J \quad \text{with } M_0 \text{ in Nm and } J \text{ in kgcm}^2$$

Thermal time constant t_{th} [min]

The constant t_{th} defines the time for the cold motor, under a load of I_0 , to heat up to an overtemperature of 0.63×105 Kelvin. This temperature rise happens in a much shorter time when the motor is loaded with the rated current.

Release delay time t_{BRH} [ms] / Application delay time t_{BRL} [ms] of the brake

These constants define the response times of the holding brake when operated with the rated voltage from the servo amplifier.

I.8.2 Technical data 6SM27..107

Data	Sym	Dim	6SM27M-4000	6SM27LL-4500	6SM37S-6000	6SM37M-6000	6SM37L-4000	6SM37VL-6000	6SM47L-3000	6SM57S-3000	6SM57M-3000	6SM77K-3000	6SM77S-3000	6SM107K-3000	6SM107S-3000
Standstill torque	M_0	Nm	0,32	0,8	0,5	1	1,5	3	3	4,6	8	11	17	26	32
Standstill current	I_{0rms}	A	0,8	0,82	1	1,6	1,6	3,8	2,3	2,8	4,3	6	10	16	20
Rated speed	n_n	min ⁻¹	4000	4500	6000	6000	4000	6000	3000	3000	3000	3000	3000	3000	3000
Torque constant	K_{Trms}	Nm/A	0,41	0,98	0,5	0,62	0,96	0,79	1,33	1,65	1,85	1,85	1,70	1,6	1,6
Voltage constant	K_{Erms}	mV/min	25	59	30	38	58	48	81	97	112	112	103	97	97
Mains supply voltage	U_n	V	400 / 460												
Rated torque at n_n	M_n	Nm	0,3	0,72	0,4	0,8	1,2	2	2,2	3	6	8,5	12	20	23
Rated current	I_n	A	0,75	0,79	0,95	1,5	1,5	2,8	2	2,7	4	5	8	14	16
Rated power	P_n	kW	0,13	0,34	0,25	0,5	0,5	1,2	0,69	0,95	1,9	2,7	4	6,3	7,2
Peak current	I_{0max}	A	3,5	3,7	4,0	6,5	6,4	15,2	9	11	17	24	40	70	85
Motor pole no.	p_{Mot}	-	6												
Resolver pole no.	p_{Res}	-	2												
Winding resistance Phase-Phase	R_{20}	Ω	31	37	36	12,8	15,5	3,65	11	6,3	3,9	2,2	1,1	0,45	0,37
Winding inductance Phase-Phase	L	mH	21	42	32	21	30	8	25	35	24	18	8,3	4,4	3,6
Insulation class	-	-	F(DIN 57530)												
Switch point thermal contact	-	$^{\circ}\text{C}$	145 \pm 5												
Design	-	-	IM B5(V1,V3), DIN 42950												
Rotor moment of inertia	J	kgcm ²	0,08	0,14	0,45	0,7	1,0	1,6	1,6	3,1	4,5	12	18	82	104
Static friction torque	M_R	Nm	0,02	0,02	0,02	0,02	0,03	0,05	0,05	0,12	0,15	0,25	0,30	0,40	0,50
Radial load permitted at shaft end with n_n	F_R	N	90	90	270	270	270	270	270	650	650	730	730	870	870
Axial load permitted at shaft end with n_n	F_A	N	30	30	90	90	90	90	90	180	180	210	210	360	360
Tolerance class flange	-	-	R, DIN 42955												
Vibration class	-	-	N, DIN ISO 2373												
Thermal time constant	t_{TH}	min	10	22	10	15	15	15	15	20	20	25	30	30	40
Weight standard	G	kg	1,1	1,45	1,9	2,3	2,9	3,5	3,5	5,7	7,6	9,8	14	28	32,5
Order number standard	-	-	83212	90486	83205	83207	83210	90702	87528	87087	86477	87526	89835	89836	89837
EMV-RES connector	-	-	12 poles, round												
RES cable, shielded	-	mm ²	4 x 2 x 0,25												
Power connection	-	-	4 + 4-poles, angled												
Motor cable, shielded	-	mm ²	4x1 or 4x1,5										4x1,5	4x2,5	
Holding torque	M_{BR}	Nm	1	2,5				6		12		20			
Operating voltage	U_{BR}	V=	24 +6/-10%												
electrical power	P_{BR}	W	8	14				16		18		22			
Moment of inertia	J_{BR}	kgcm ²	0,07	0,38				1,06		3,6		9,5			
Release delay time	t_{BRH}	ms	15-20				10-15		10-30		30-60		20-60		
Application delay time	t_{BRL}	ms	5-10				10-15		5-15		10-20		10-35		
Weight of the brake	G_{BR}	kg	0,3				0,4		0,6		1,5		3,3		
Motor cable with brake, shielded	-	mm ²	4x1 + 2x0,75 or 4x1,5 + 2x0,75										4x1,5+ 2x0,75	4x2,5 + 2x1	
Order number with -G-	-	-	83213	89594	83206	83209	83211	90703	87529	86792	87088	87527	89864	89865	89866

This page has been deliberately left blank.

II Installation / Commissioning

II.1 Important notes

- Check that the servo amplifier and motor match each other. Compare the rated voltage and rated current of the unit. Carry out the wiring according to the wiring diagram in the Installation and Commissioning Instructions for the servo amplifier. The connections to the motor are shown on page 23. Notes on the connection methods can be found on page 18.
- Ensure that there is proper earthing of the servo amplifier and the motor.
- Route the power and control cables as separately as possible from one another (separation > 20 cm). This will improve the immunity of the system to electromagnetic interference.
If a motor power cable is used which includes integral brake control leads, then these brake control leads must be shielded. The shielding must be connected at both ends (see under Installation Instructions for the servo amplifier).
- Install all cables carrying a heavy current with an adequate cross-section, as per EN 60204. The recommended cross-section can be found in the Technical data.

Caution!

If a servo amplifier of the series SERVOSTAR is used and the motor cable exceeds 25m, a boxed choke (type 3YL-xx, manufactured by Danaher Motion) and motor leads with the following diameters must be used:

servo amplifier	choke box	Max. cable diameter
digifas® 7201...7206	3YL-06	4 x 1mm ²
SERVOSTAR 601...606	3YL-20	4 x 1mm ²
SERVOSTAR 610	3YL-20	4 x 1,5mm ²
SERVOSTAR 620	3YL-20	4 x 2,5 mm ²

- Connect up all shielding via a wide surface-area contact (low impedance) and metallized connector housings or EMC-PG glands.
- Check the compliance to the permitted radial and axial forces F_R and F_A . Observe the reduced permitted axial force with built-in brake. (\Rightarrow I.8.2).
When you use a toothed belt drive, the **minimal** permitted diameter of the pinion e.g. follows from the equation: $d_{\min} \geq \frac{M_0}{F_R} \times 2$.
- Ensure that there is adequate heat transfer in the surroundings and the motor flange, so that the maximum permissible flange temperature is not exceeded in S1 operation.



Caution!

Never undo the electrical connections to the motor while it is energised. A dangerous voltage, resulting from residual charge, can be still present on the capacitors up to 300 seconds after switch-off of the mains supply.

Measure the DC-link voltage and wait until it has fallen below 40V.

Even when the motor is not rotating, control and power leads may be live.

II.2 Assembly / Wiring

Only qualified staff with knowledge of mechanical engineering are permitted to assemble the motor.

Only staff qualified and trained in electrical engineering are allowed to wire up the motor.

The procedure is described as an example. A different method may be appropriate or necessary, depending on the application of the equipment.



Warning!

Protect the motor from unacceptable stresses.

Take care, especially during transport and handling, that components are not bent and that insulation clearances are not altered.



Always make sure that the motors are de-energized during assembly and wiring, i.e. No voltage may be switched on for any piece of equipment which is to be connected.

Ensure that the switch cabinet remains turned off (barrier, warning signs etc.). The individual voltages will only be turned on again during commissioning



Note!

The ground symbol $\perp\perp\perp$, which you will find in the wiring diagrams, indicates that you must provide an electrical connection, with as large a surface area as possible, between the unit indicated and the mounting plate in the switch cabinet. This connection is to suppress HF interference and must not be confused with the PE (protective earth) symbol (protective measure to EN 60204).

To wire up the motor, use the wiring diagrams in the Installation and Commissioning Instructions of the servo amplifier which is used.

The following notes should help you to carry out the assembly and wiring in an appropriate sequence, without overlooking anything.



Site	The site must be free of conductive and aggressive material. For V3-mounting (shaft end upwards), make sure that no liquids can enter the bearings. If an encapsulated assembly is required, please consult our applications department beforehand.
Ventilation	Ensure an unhindered ventilation of the motors and observe the permissible ambient and flange temperatures. For ambient temperatures above 40°C please consult our applications department beforehand.
Assembly	During assembly, take care that the motor is not overstressed when it is fixed in place.
Cable selection	Select cables according to EN 60204 See the table in chapter II.1 when cable length exceeds 25m.
Earthing Shielding	Use correct earthing and EMC-shielding according to the Installation Instructions for the servo amplifier which is used. Earth the mounting plate and motor casing. For connection methods see chapter II.2.1
Wiring	<ul style="list-style-type: none">— Route power cables as separately as possible from control cables— Connect up the resolver— Connect the motor leads, install ring cores or motor chokes close to the servo amplifier, connect shields to shielding terminals or EMC connectors at both ends— Connect the holding brake, if used, Connect shielding at both ends.
Check	Final check of the installed wiring, according to the wiring diagram which was used

II.2.1

Connection methods



- Carry out the wiring in accordance with the valid standards and regulations.
- Only use our preassembled shielded leads for the resolver and power connections.
- Connect up the shielding according to the wiring diagrams in the Installation Instructions for the servo amplifier.
- Incorrectly installed shielding inevitably leads to EMC interference.

In the table below you find all leads supplied by us. Further information referring to chemical, mechanical and electrical qualities can be received from our applications department.

Insulating material

Sheathing - PUR (Polyurethane, identification 11Y)
 core insulation - PETP (Polyesteraphtalate, identification 12Y)

Capacity

Motor lead - less than 150 pF/m
 Feedback lead - less than 120 pF/m

Technical Data

- All leads are suitable for trailing.
- Technical data refer to mobile usage of leads.
 Life time : 1 Million bending cycles
- The temperature range refers to the operation temperature.
- Identification:

N	=	numbered cores
F	=	cores with colour code according to DIN 47100
B	=	cores with letter identification
()	=	shielding

Cores [mm ²]	Identification	Temperature range [°C]	Cable diameter [mm]	Bending radius [mm]	Remarks
(4x1,0)	F	-30 / +80	10,5	105	Motor lead
(4x1,5)	B	-30 / +80	11,3	115	
(4x2,5)	N	-5 / +70	12,7	125	
(4x1,0+(2x0,75))	F	-30 / +80	12	120	Motor lead with integral brake control leads
(4x1,5+(2x0,75))	B	-10 / +80	12,5	125	
(4x2,5+(2x1))	B	-30 / +80	13,8	140	Resolver lead
(4x2x0,25)	F	-30 / +80	6,9	60	

II.3 Commissioning

The procedure for commissioning is described as an example. A different method may be appropriate or necessary, depending on the application of the equipment.

Only specialist personnel with extensive knowledge in the areas of electrical engineering / drive technology are allowed to commission the drive unit of servo amplifier and motor.



Caution!

Check that all live connection points (terminal boxes) are safe against accidental contact. Deadly voltages can occur, up to 900V.

Never undo the electrical connections to the motor when it is live. The residual charge in the capacitors of the servo amplifier can produce dangerous voltages up to 300 seconds after the mains supply has been switched off.

The surface temperature of the motor can reach 100°C in operation. Check (measure) the temperature of the motor. Wait until the motor has cooled down below 40°C before touching it.

Make sure that, even if the drive starts to move unintentionally, no danger can result for personnel or machinery.

- 
- Check the assembly and orientation of the motor.
 - Check the drive components (clutch, gear unit, belt pulley) for the correct seating and setting (observe the permissible radial and axial forces).
 - Check the wiring and connections to the motor and the servo amplifier. Check that the earthing is correct.
 - Test the function of the holding brake, if used. (apply 24V, the brake must be released).
 - Check whether the rotor of the motor revolves freely (release the brake, if necessary). Listen out for grinding noises.
 - Check that all the required measures against accidental contact with live and moving parts have been carried out.
 - Carry out any further tests which are specifically required for your system.
 - Now commission the drive according to the commissioning instructions for the servo amplifier.
 - In multi-axis systems, individually commission each drive unit (servo amplifier and motor).

This page has been deliberately left blank.

III Drawings

III.1 Dimensions 6SM27..107 with resolver

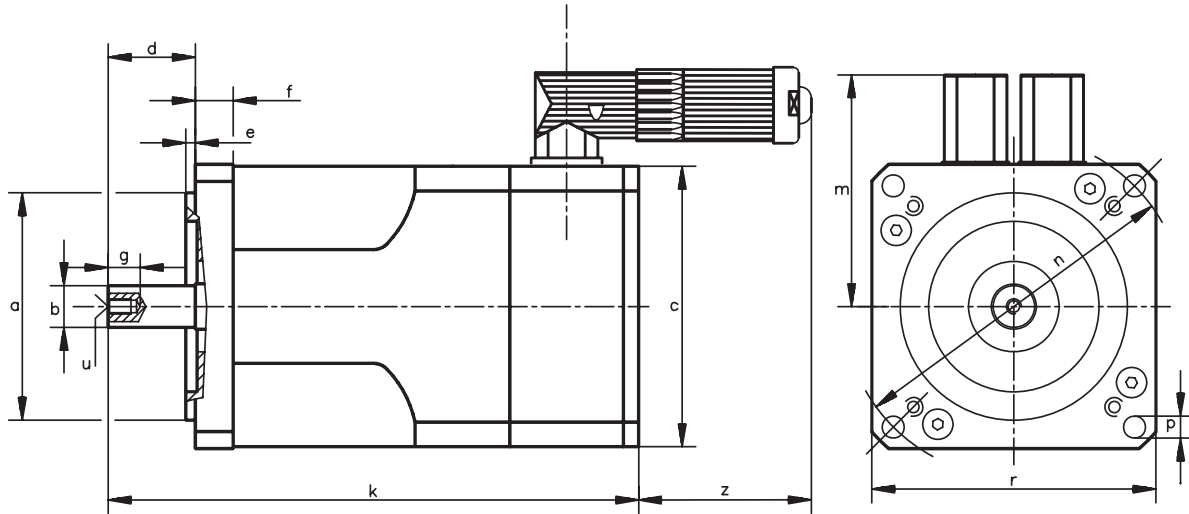

Shaft end WITHOUT
keyway to
DIN 748

Centering with
internal thread
acc. to DIN 332

	a _{j6}	b _{k6}	c	d	e	f	g	k	k(-G-)	m	n	p	r	u	z
	mm	mm	mm	mm	mm	mm	mm	mm	mm	mm	mm	mm	mm		mm
6SM27M 6SM27LL	40	9	50	20	2,5	7	-	142 172	175 205	62,5	63	5,8	55	-	75
6SM37S 6SM37M 6SM37L 6SM37VL	60	11 11 11 14	74	23 23 23 30	2,5	10	10 10 10 17	139 157 175 225	172 190 208 258	69,5	90	5,8	75	M4 M4 M4 M5	75
6SM47L	80	14	74	30	3	9	17	218	251	69,5	100	7	88	M5	75
6SM57S 6SM57M	95	19	97	40	3	10	22	225 270	260 305	81	115	9	105	M5	75
6SM77K 6SM77S	130	24	127	50	3,5	11	27	266 321	309 364	96	165	11	142	M8	75
6SM107K 6SM107S	180	32	190	58	4	13	42	298 321	342 365	128	215	14	190	M12	75

III.2 Dimensions 6SM27..107 with encoder

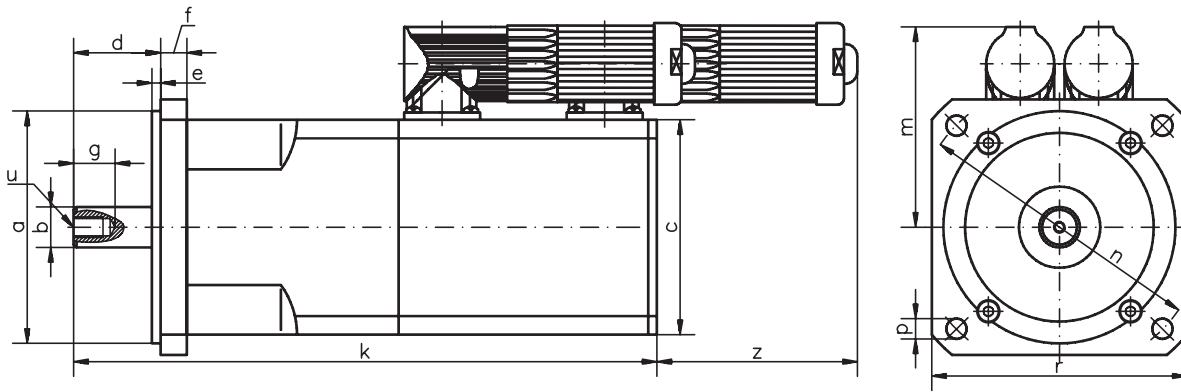

Shaft end WITHOUT keyway to DIN 748

Centering with internal thread acc. to DIN 332

	a _{j6}	b _{k6}	c	d	e	f	g	k	k(-G-)	m	n	p	r	u	z
	mm	mm	mm	mm	mm	mm	mm	mm	mm	mm	mm	mm	mm		mm
6SM37S-S3	60	11		23			10	195	228	70	90	5,8	75	M4	82,5
6SM37M-S3		11	74	23	2,5	10	10	213	246						
6SM37L-S3		11		23			10	231	264						
6SM37VL-S3		14		30			17	274	307						
6SM47L-S3	80	14	74	30	3	9	17	273	306	70	100	7	88	M5	82,5
6SM57S-S3	95	19	97	40	3	10	22	261	293	81	115	9	105	M5	68,5
6SM57M-S3								306	338						
6SM77K-S3	130	24	127	50	3,5	11	27	289	332	81	165	11	142	M8	68,5
6SM77S-S3								340	383						
6SM107K-S3	180	32	190	58	4	13	42	317	361	82	215	14	190	M12	66,5
6SM107S-S3								340	384						

III.3 Radial-/axial force at the shaft end

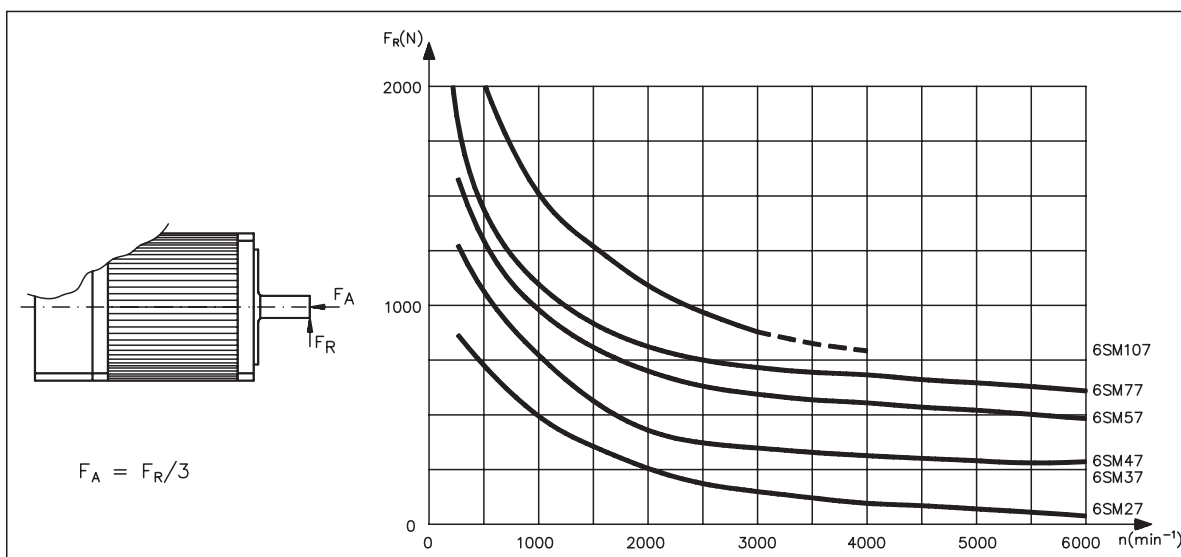

III.4 Wiring diagram 6SM27..107 with resolver

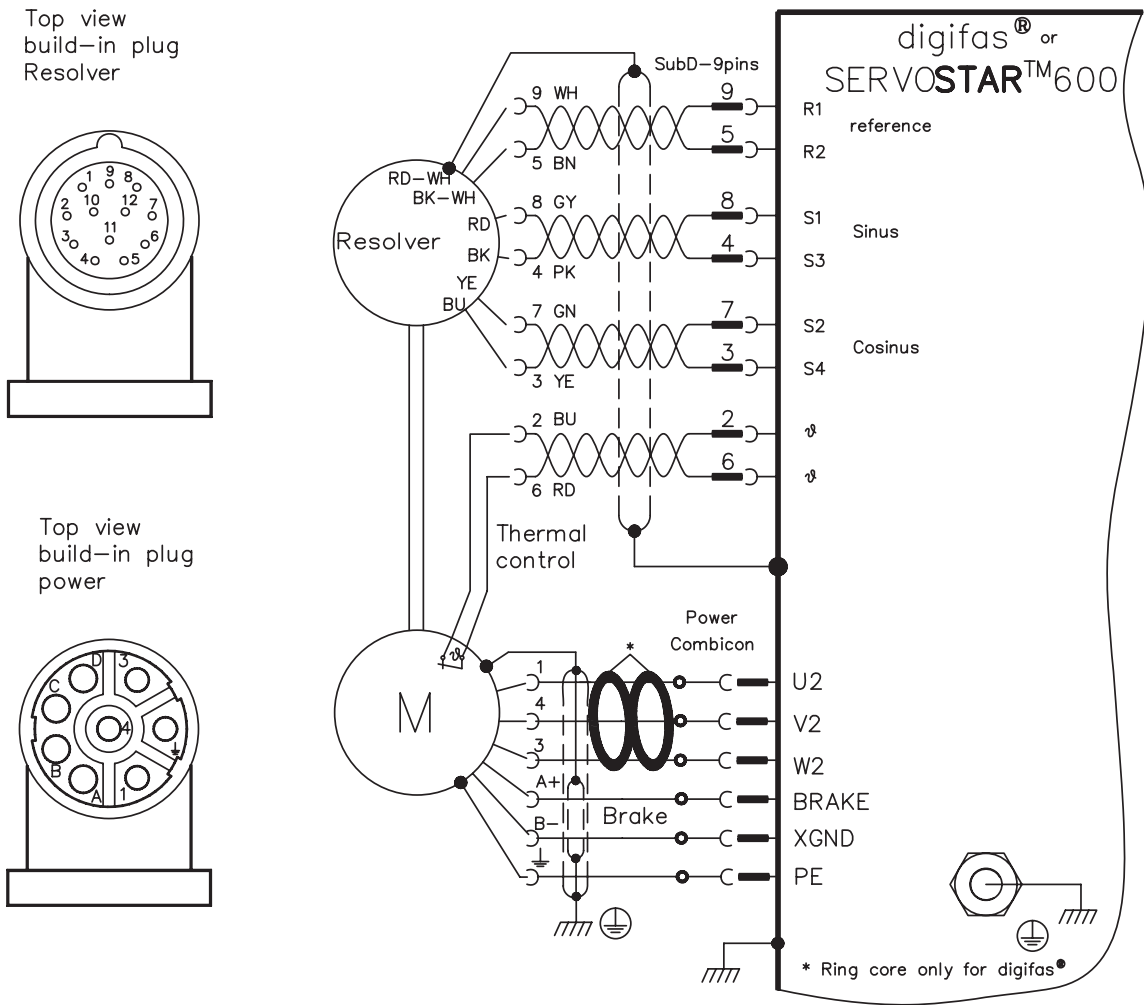

connector round, 12-poles

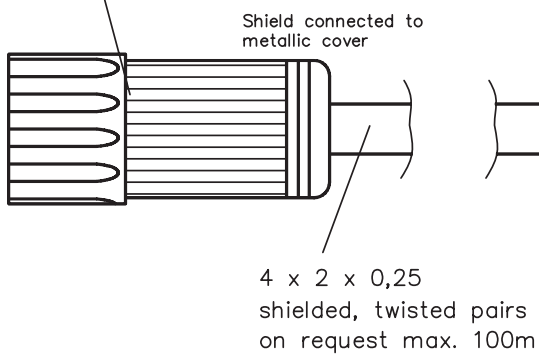

Colour coding acc. to IEC 757

Sub-D connector 9-poles

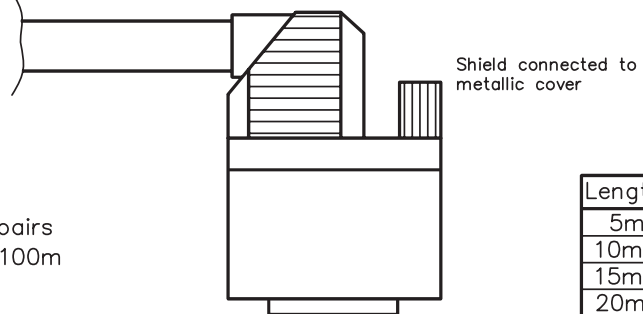

Length	Mat.No.
5m	84972
10m	84973
15m	84974
20m	84975

Res. cable f. 6SM with connector

III.5 Wiring diagram 6SM27..107 with encoder

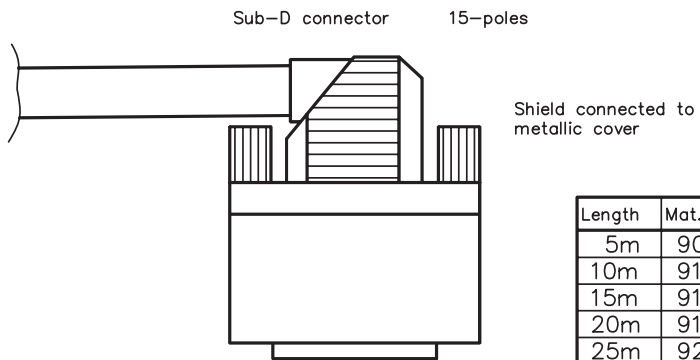
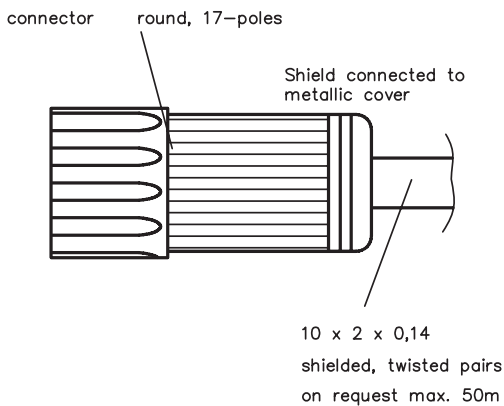
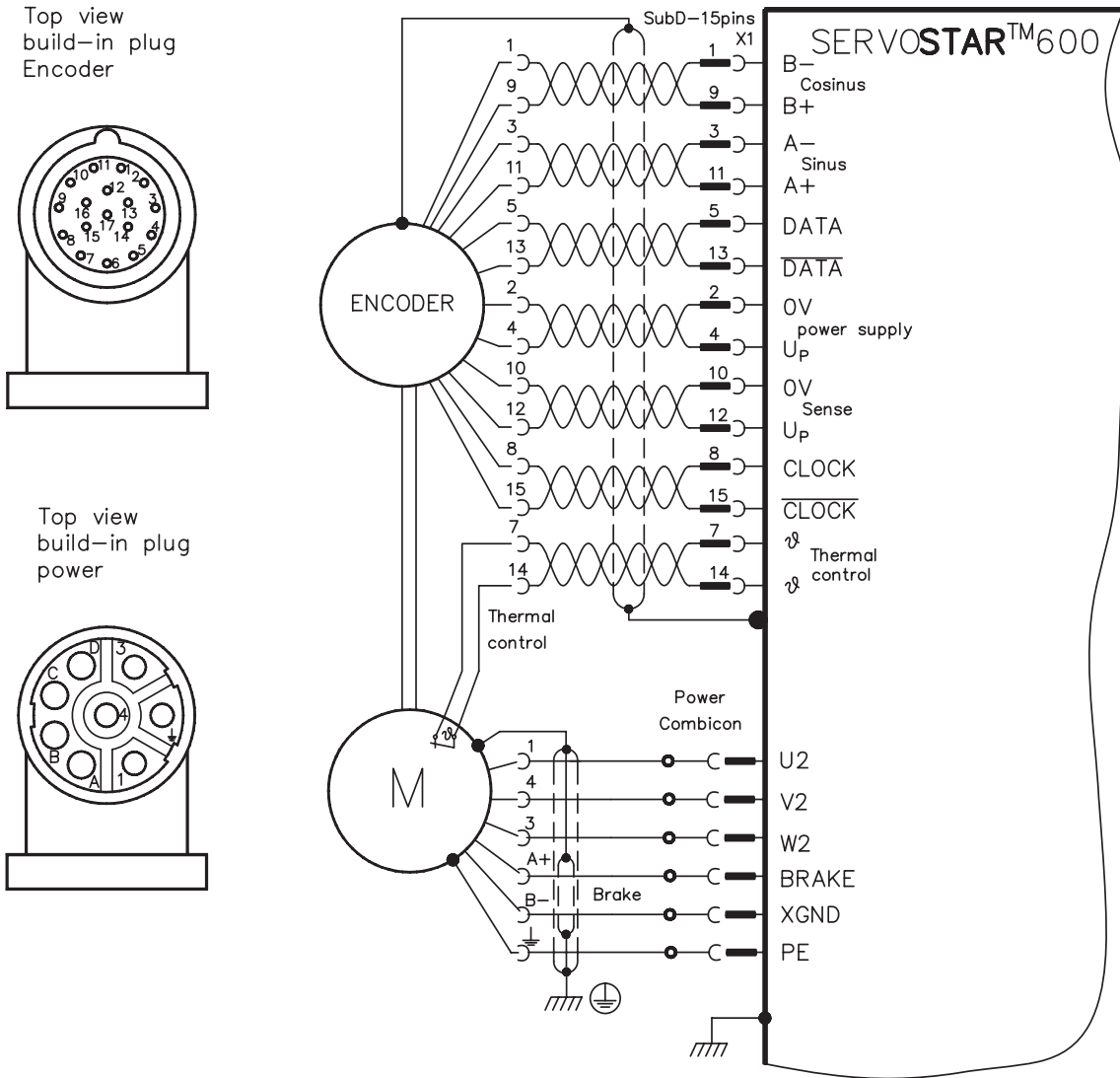

Length	Mat.No.
5m	90287
10m	91019
15m	91811
20m	91807
25m	92205

Enc. cable f. 6SM with connector

III.6 Torque characteristics 6SM27M-4000

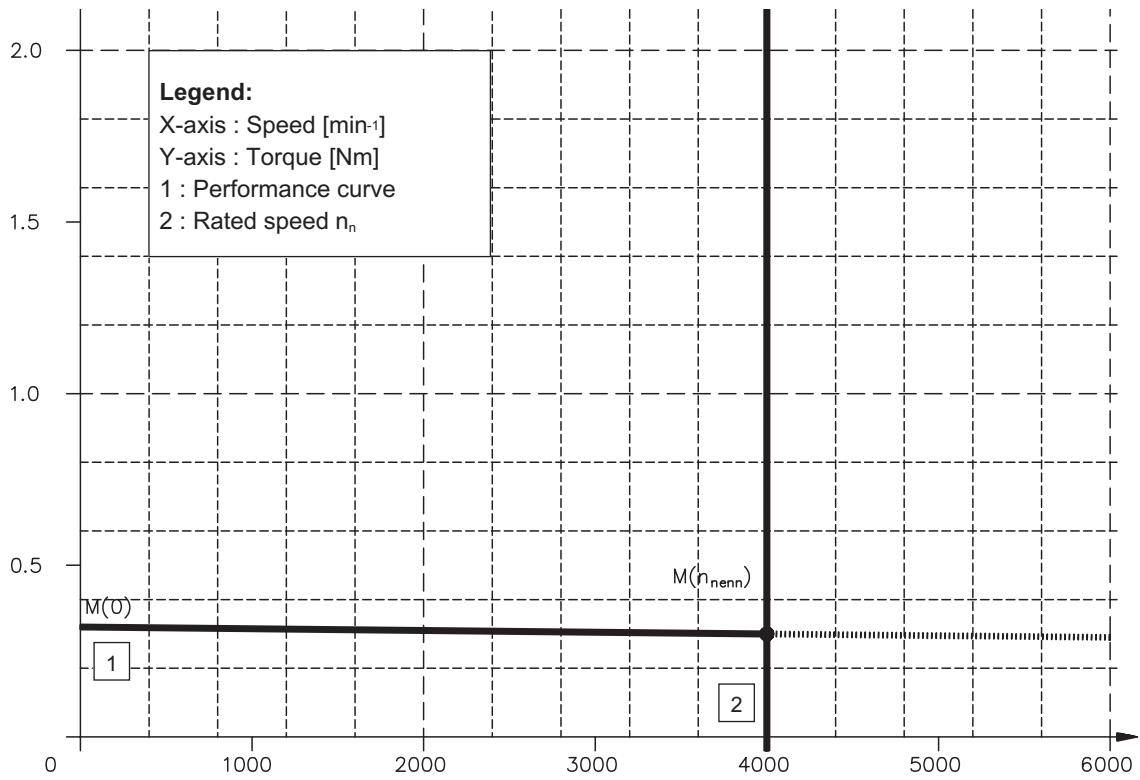

III.7 Torque characteristics 6SM27LL-4500

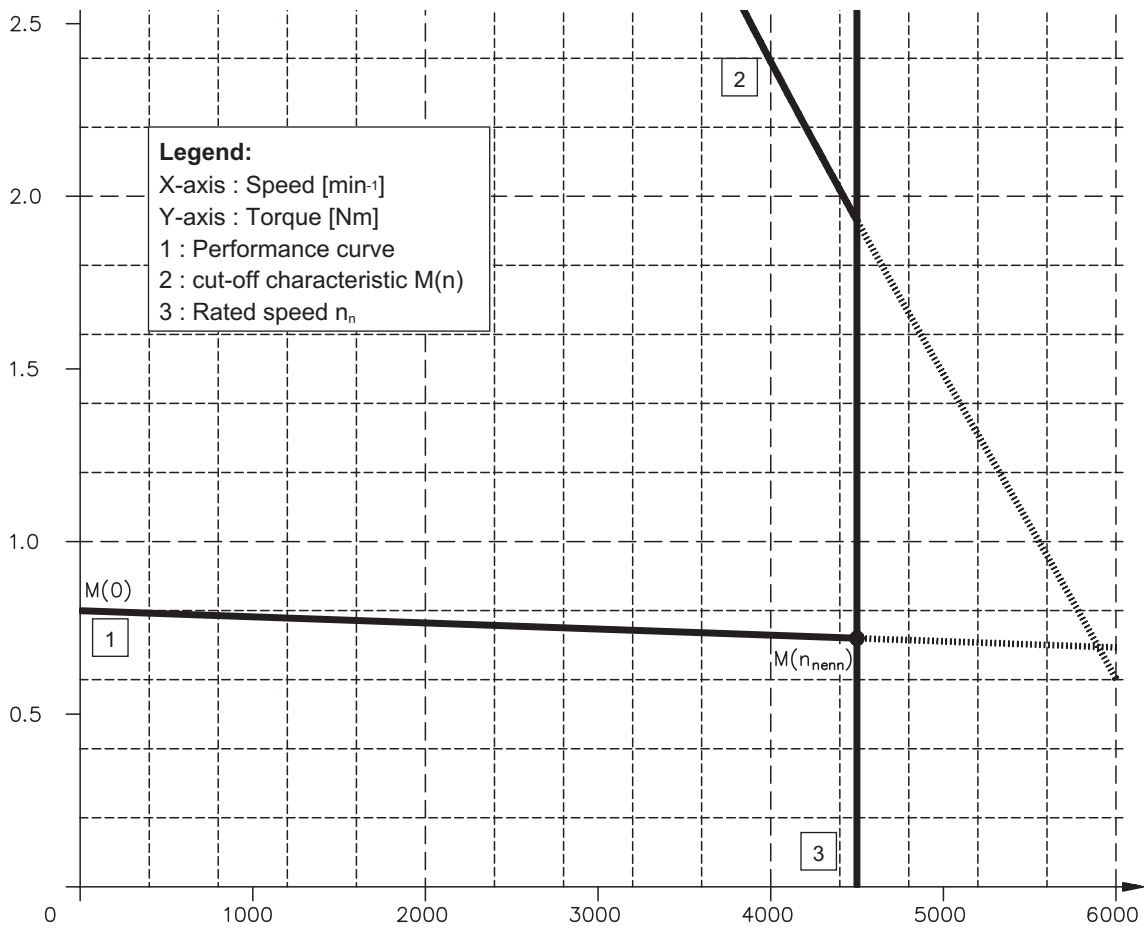

III.8 Torque characteristics 6SM37S-6000

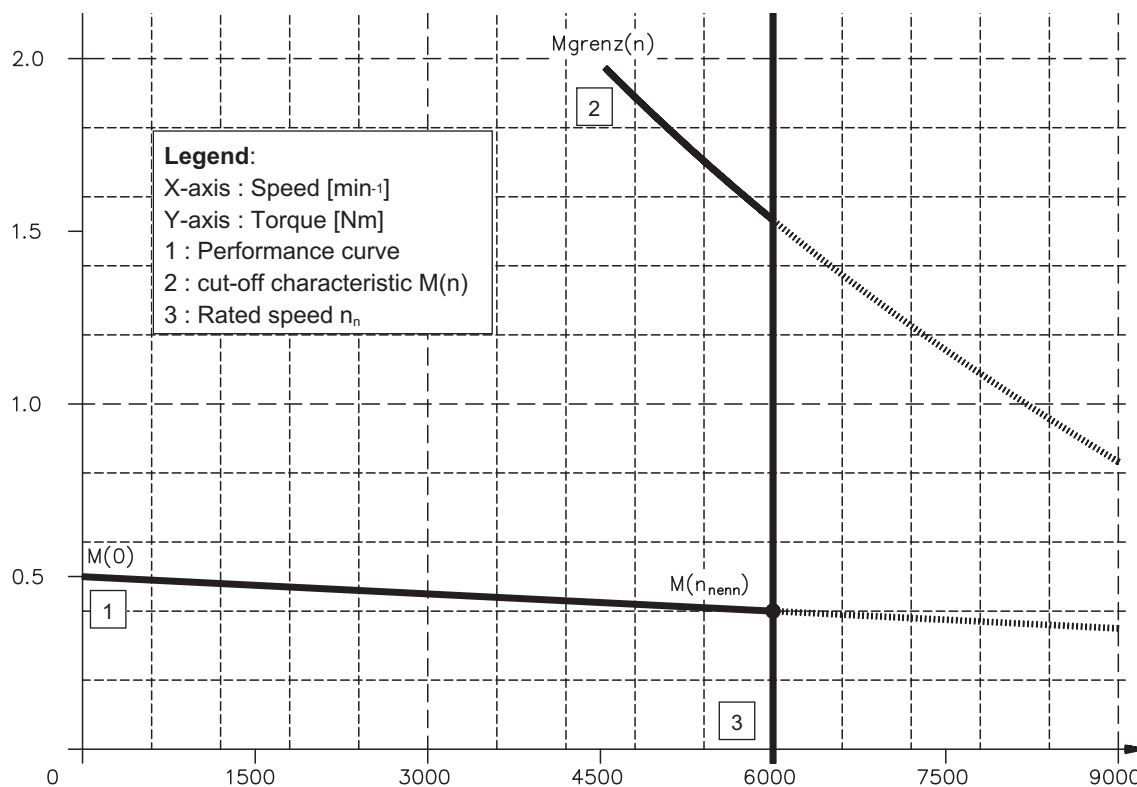

III.9 Torque characteristics 6SM37M-6000

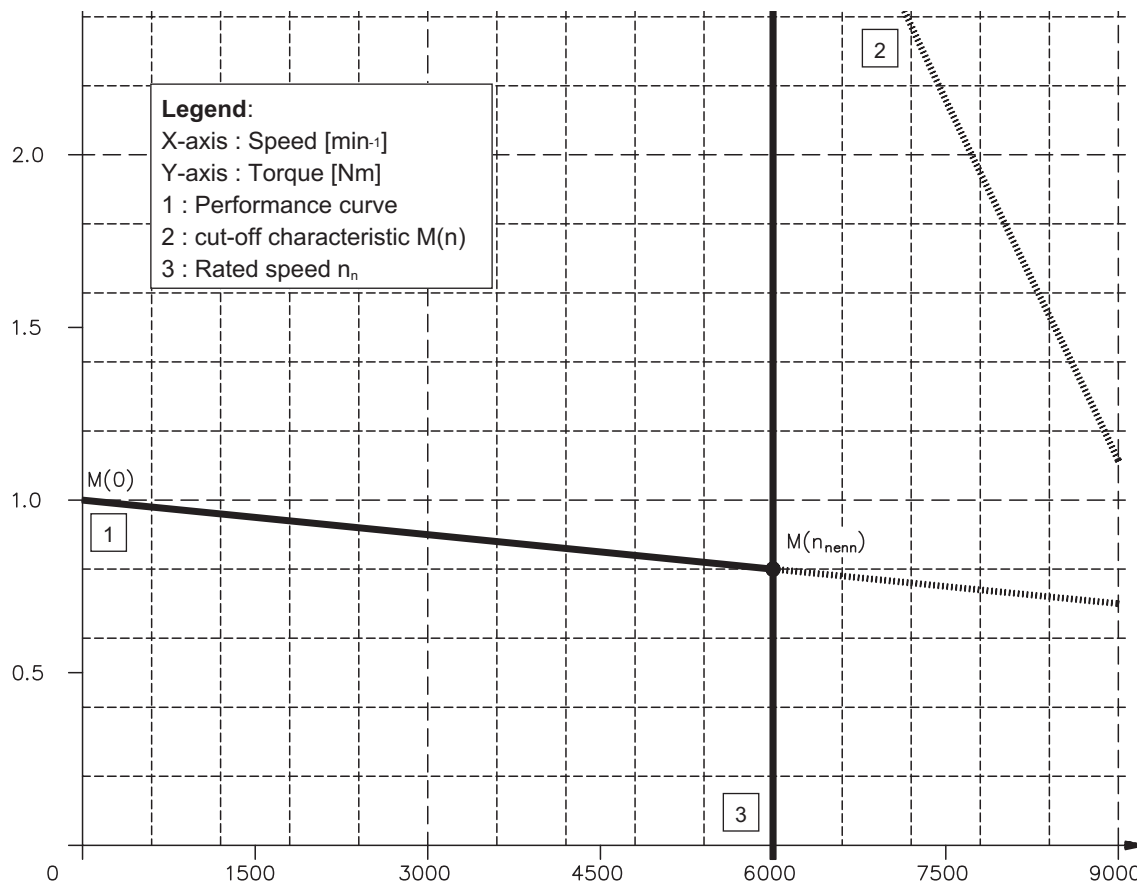

III.10 Torque characteristics 6SM37L-4000

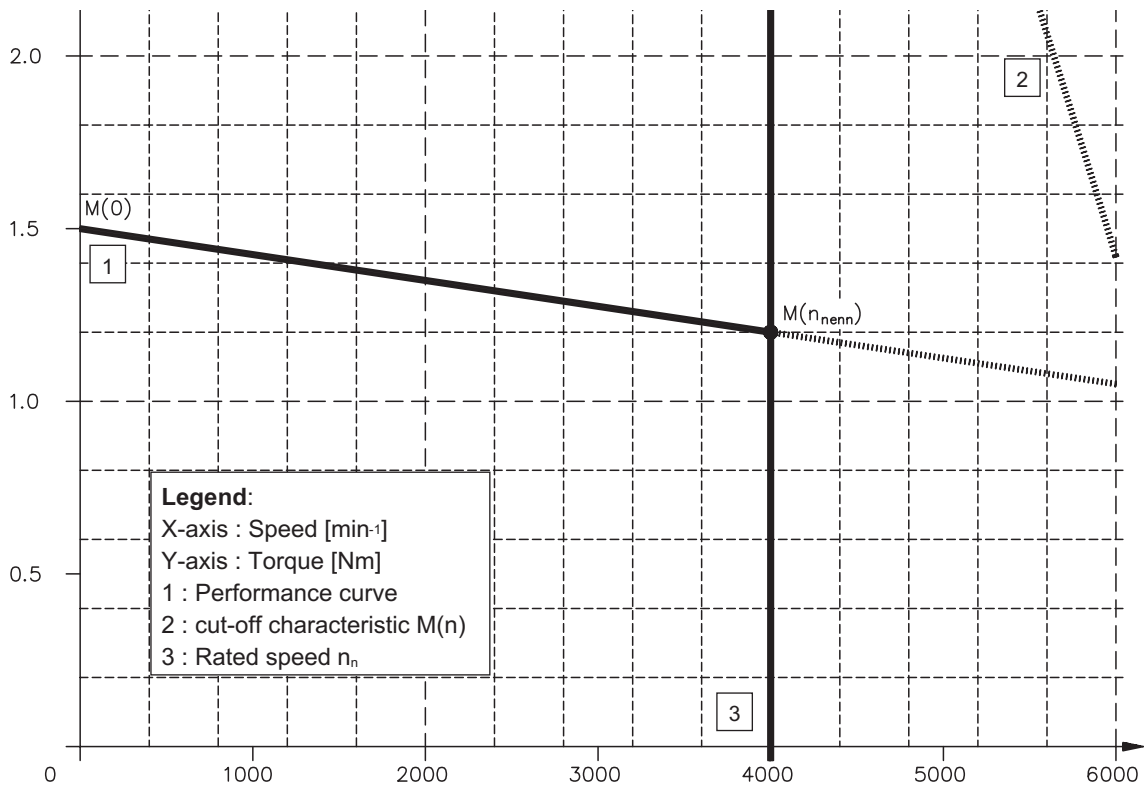

III.11 Torque characteristics 6SM37VL-6000

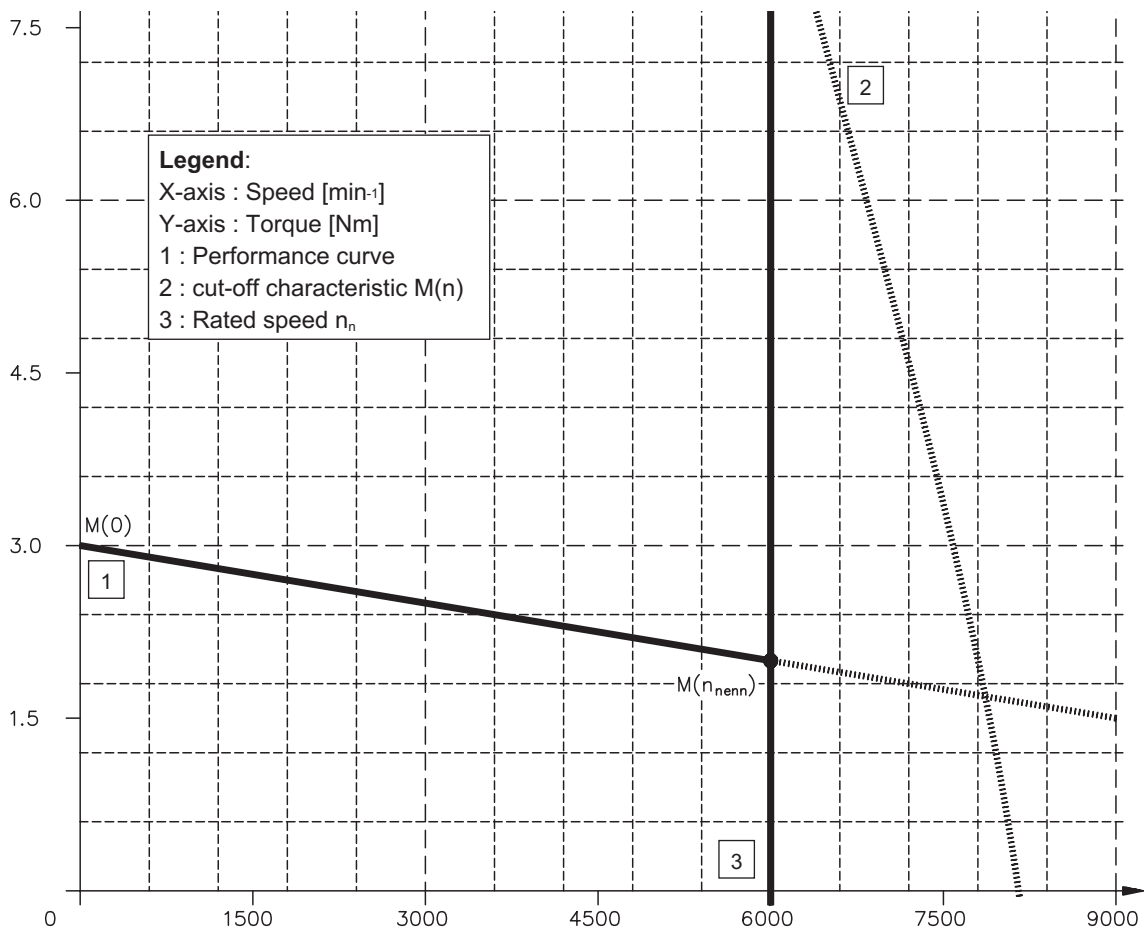

III.12 Torque characteristics 6SM47L-3000

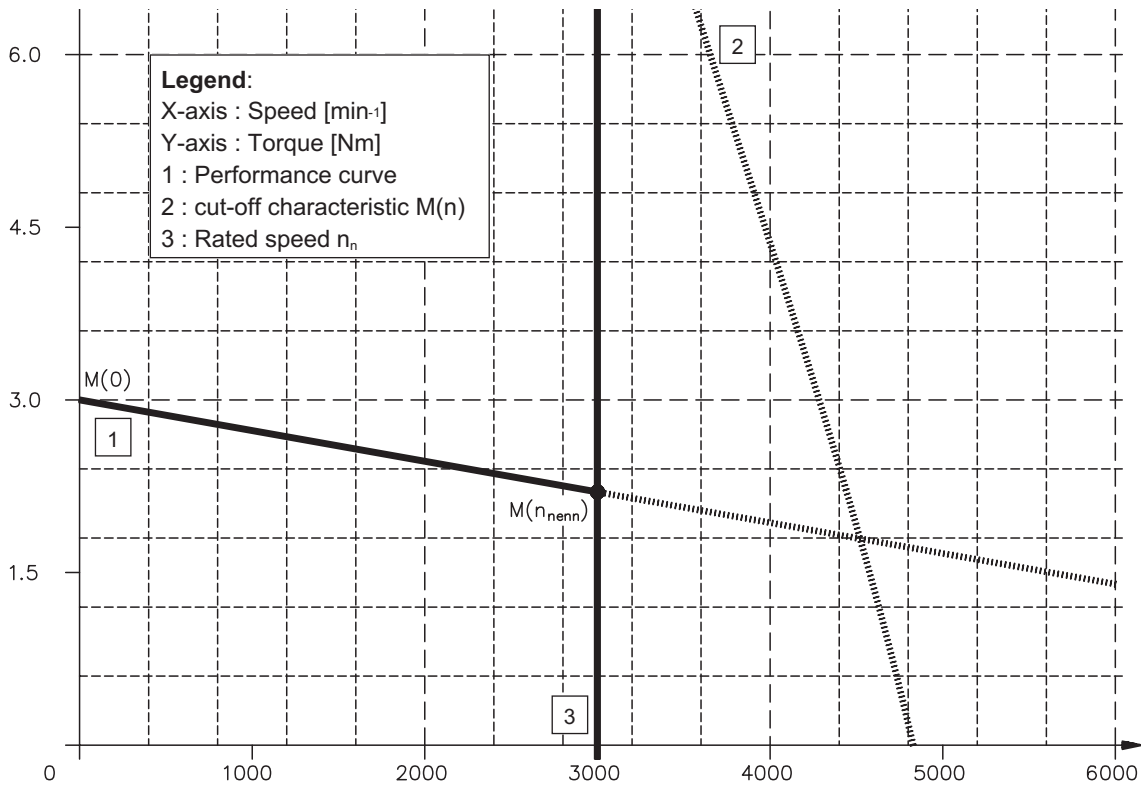

III.13 Torque characteristics 6SM57S-3000

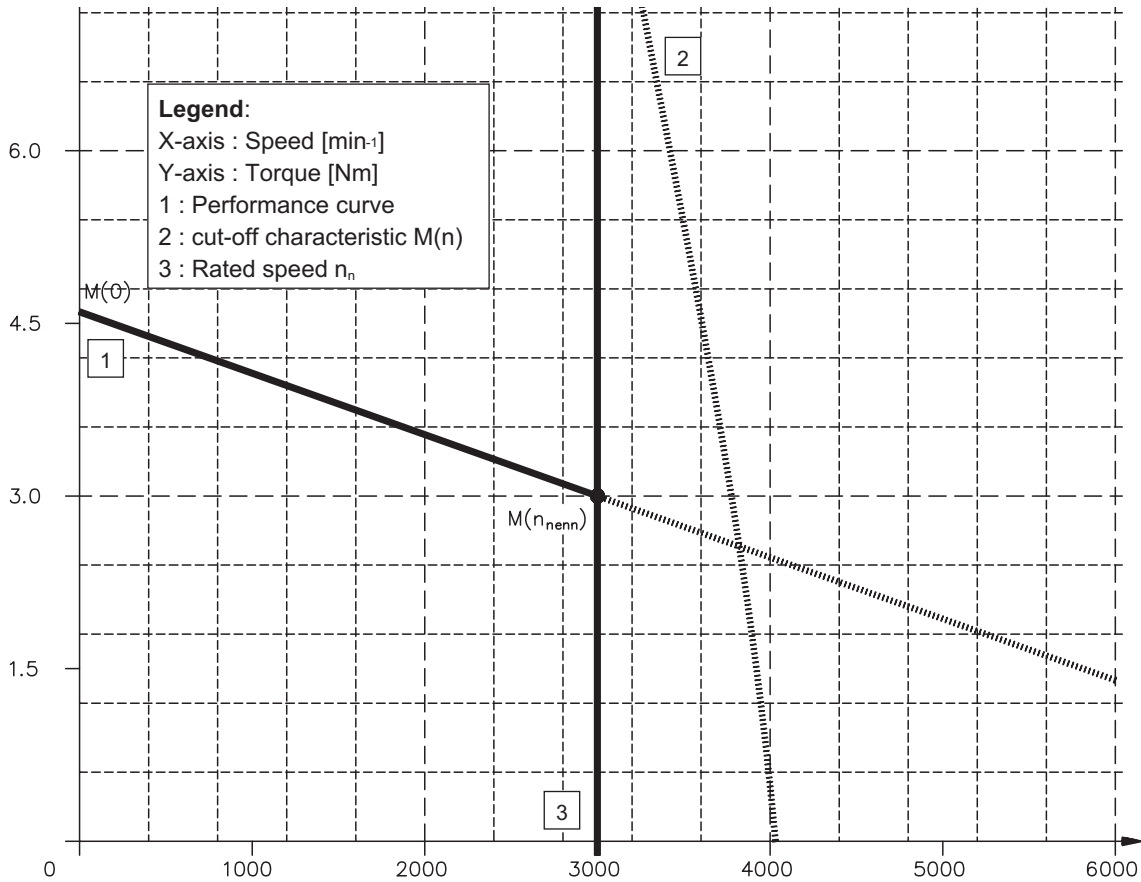

III.14 Torque characteristics 6SM57M-3000

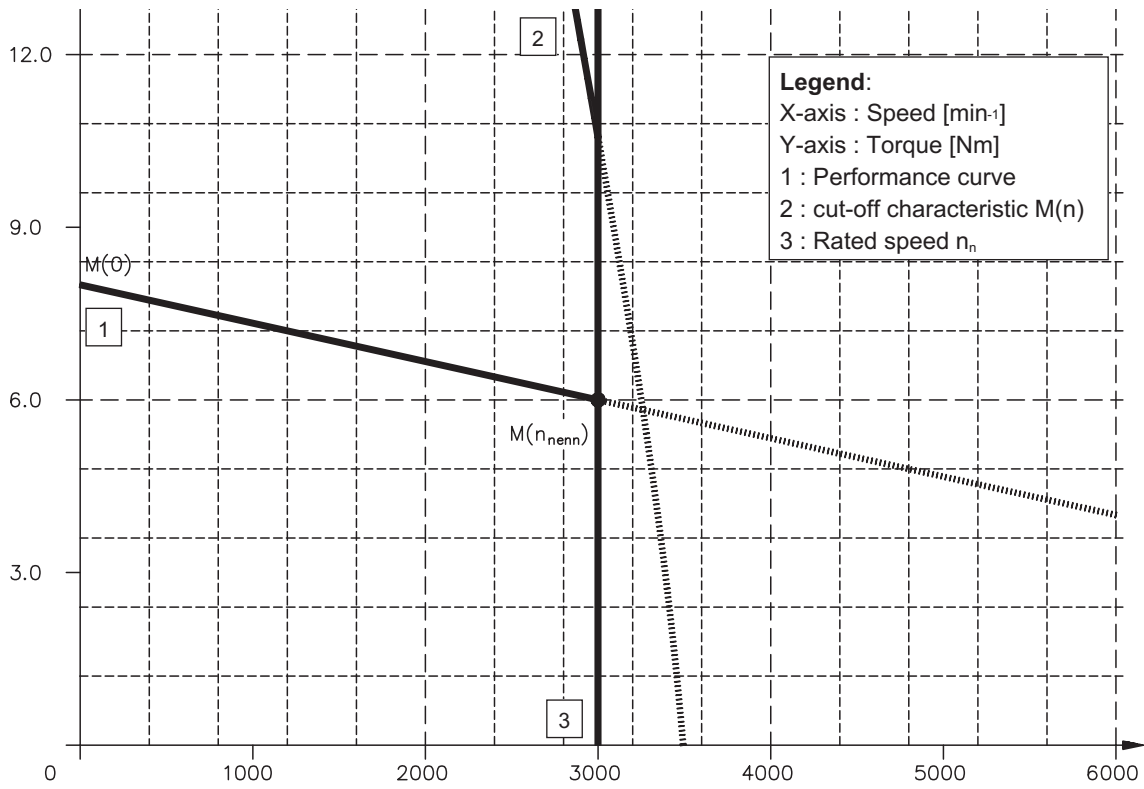

III.15 Torque characteristics 6SM77K-3000

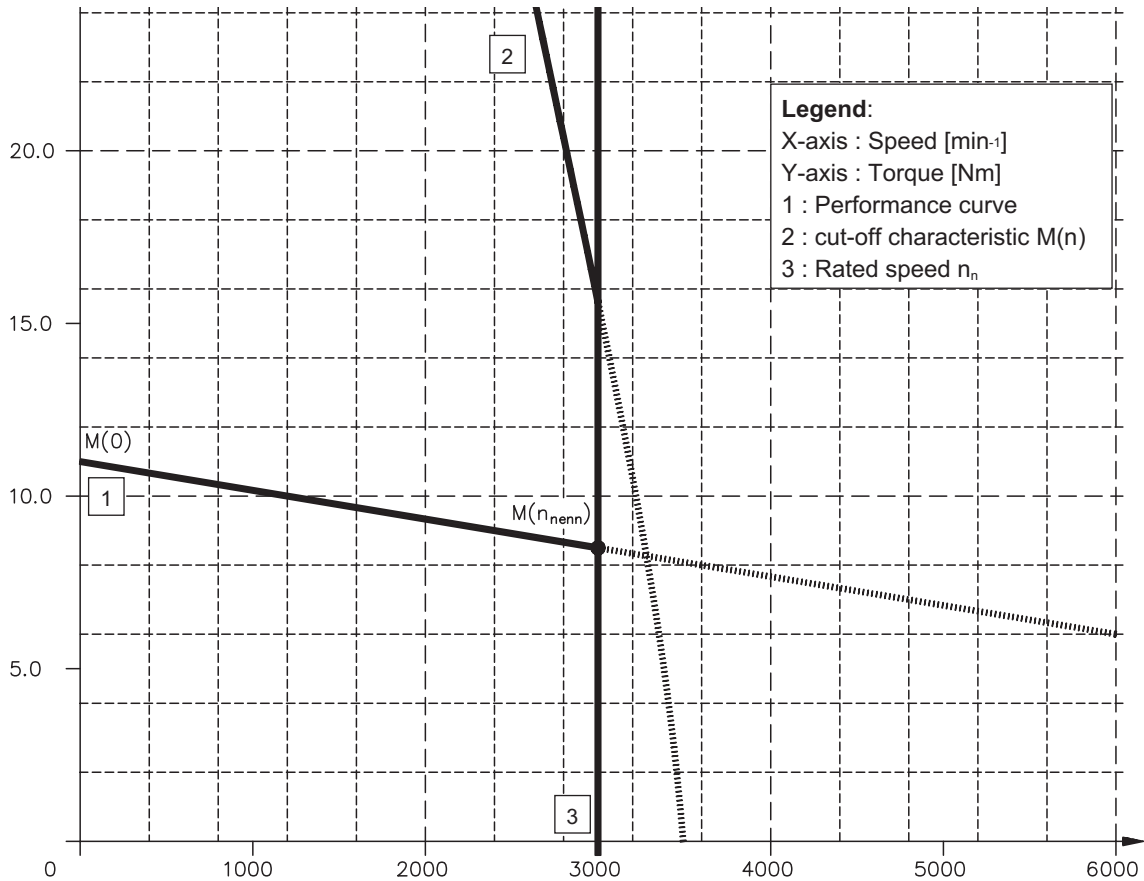

III.16 Torque characteristics 6SM77S-3000

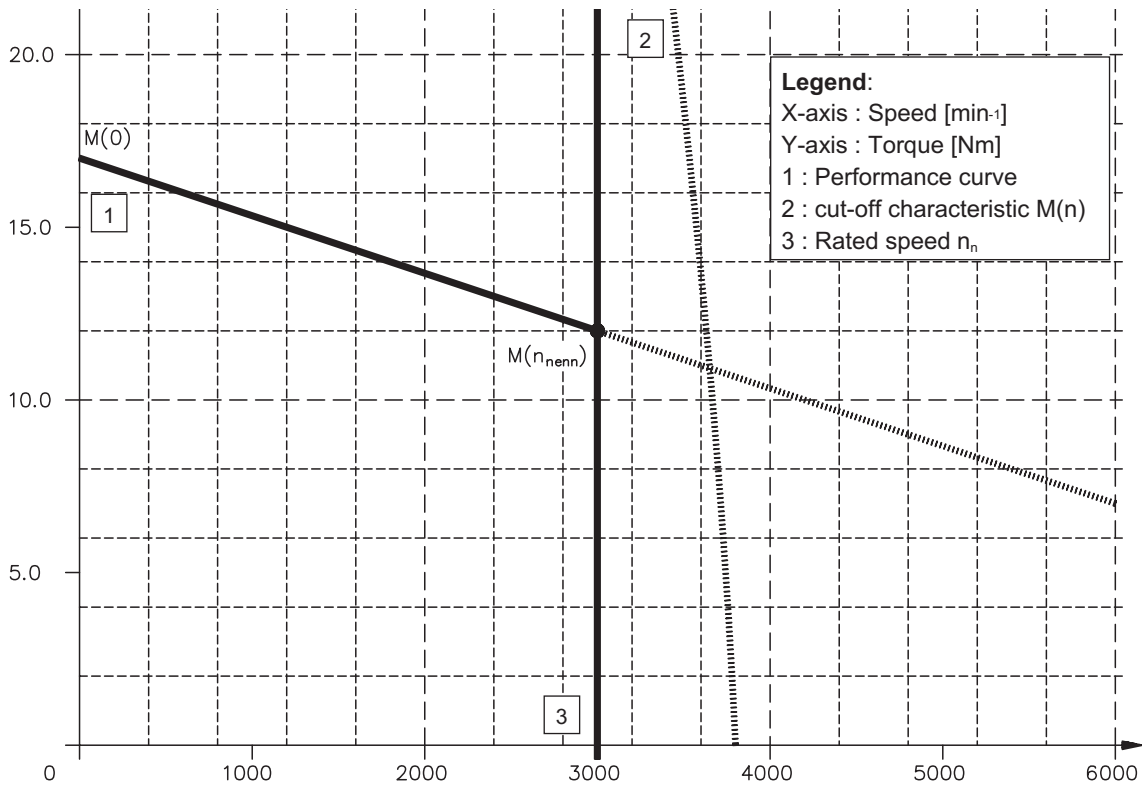

III.17 Torque characteristics 6SM107K-3000

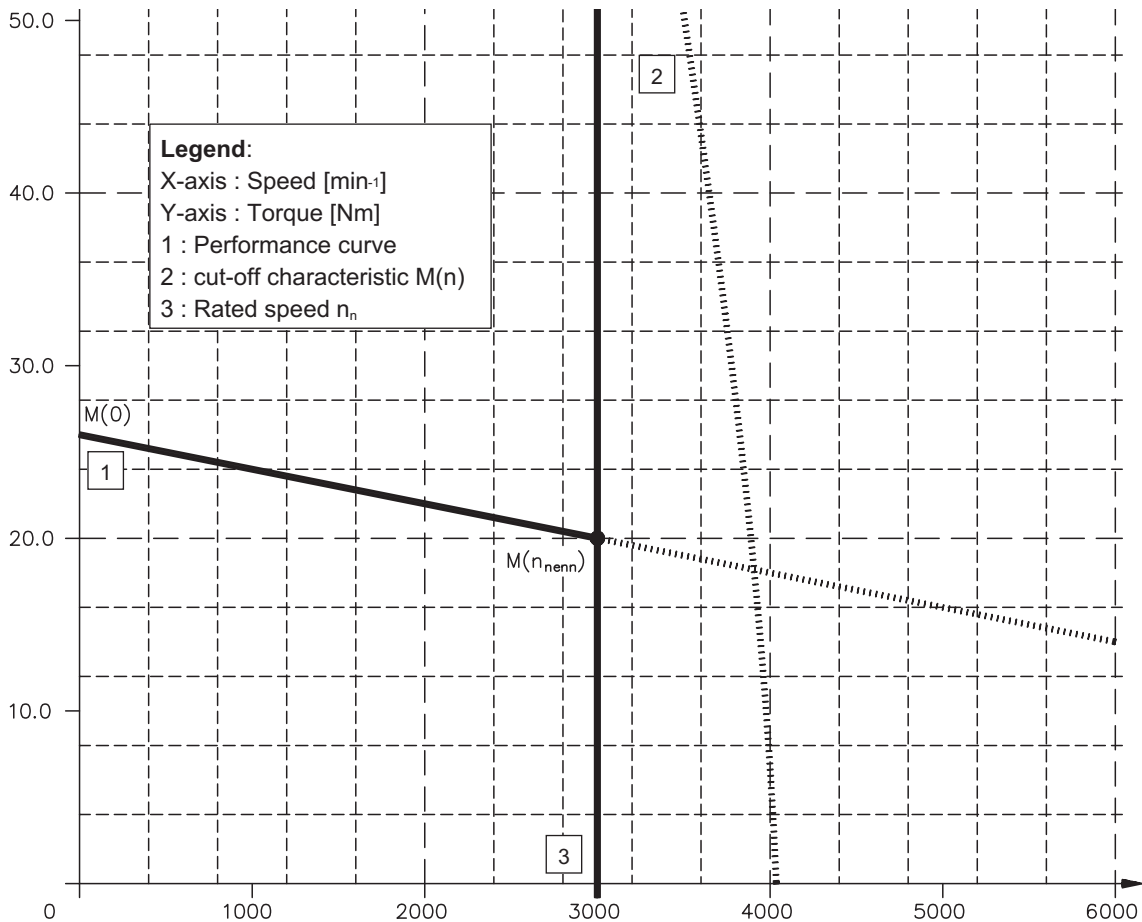

III.18 Torque characteristics 6SM107S-3000

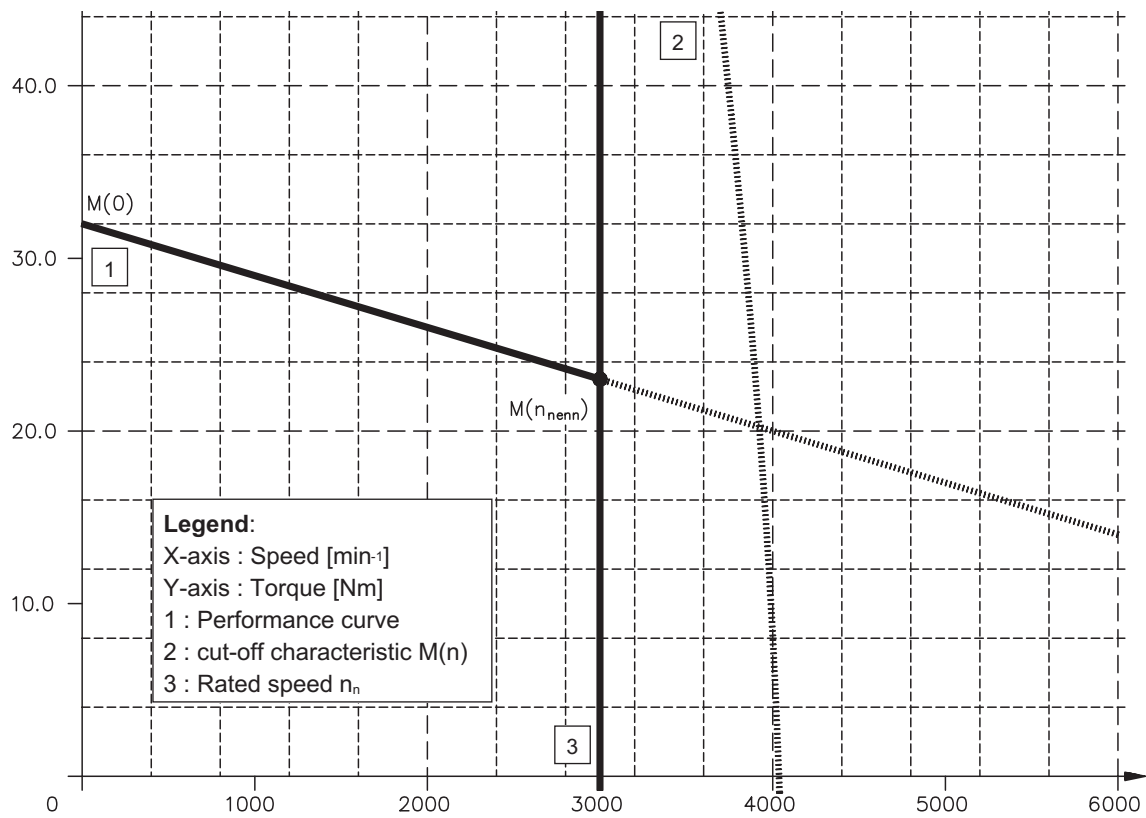

This page has been deliberately left blank.

IV Appendix

IV.1 Delivery package, transport, storage, maintenance, disposal

- Delivery package:** — Motor from the 6SM27..107 series
 — Technical description (documentation), 1 copy per delivery
 — Motor package leaflet (short info)

- Transport:** — Climate category 2K3 to EN 50178
 Transport temperature—25...+70°C, max. 20K/hr change
 Transport humidity rel. humidity 5% - 95% , no condensation
 — only by qualified personnel
 — only in the manufacturer's original recyclable packaging
 — avoid shocks
 — if the packaging is damaged, check the motor for visible damage.
 Inform the carrier and, if appropriate, the manufacturer.

Packaging:

Motor type	Carton	Pallet or skeleton box	Max.stacking height
6SM27/37	X		10
6SM47	X		6
6SM57	X		6
6SM77	X		5
6SM107		X	1

- Storage:** — Climate category 1K4 to EN 50178
 Storage temperature —25...+55°C, max. variation 20K/hr.
 Humidity rel. humidity 5% - 95%, no condensation
 — only in the manufacturer's original recyclable packaging
 — max. stacking height see table under Packaging
 — Storage time unlimited

- Maintenance:** — Only by qualified personnel
 — The ball bearings have a grease packing which is adequate for 20,000 hours of operation under normal conditions. The bearings should be replaced after 20,000 hours of operation under rated conditions.
 — Check the motor for bearing noise every 2500 operating hours, respectively each year. If any noises are heard, then the operation of the motor must stop, the bearings must be replaced.
 — Opening the motor invalidates the warranty.

- Cleaning:** — If the housing is dirty: clean with Isopropanol or similar.
do not immerse or spray

- Disposal:** — The disposal should be carried out by a certified disposal company.
 Ask us for addresses.

IV.2 Fault-finding

The following table is to be seen as a “First Aid” box. There can be a large number of different reasons for a fault, depending on the particular conditions in your system. The fault causes described below are mostly those which directly influence the motor. Peculiarities which show up in the control loop behaviour can usually be traced back to an error in the parameterization of the servo amplifier. The documentation for the servo amplifier and the operator software provides information on these matters.

For multi-axis systems there may be further hidden reasons for faults.

Our applications department can give you further help with your problems.

Fault	Possible cause	Measures to remove the cause of the fault
Motor doesn't rotate	<ul style="list-style-type: none"> — servo amplifier not enabled — Break in setpoint lead — Motor phases in wrong sequence — Brake not released — Drive is mechanically blocked 	<ul style="list-style-type: none"> — Supply ENABLE signal — Check setpoint lead — Correct the phase sequence — Check brake controls — Check mechanism
Motor runs away	<ul style="list-style-type: none"> — Motor phases in wrong sequence — ROD cable faulty or not properly plugged in (for option -IL-) 	<ul style="list-style-type: none"> — Correct the phase sequence — Check ROD/SSI cable
Motor oscillates	<ul style="list-style-type: none"> — Break in the shielding of the resolver cable — amplifier gain too high 	<ul style="list-style-type: none"> — Replace resolver cable — use motor default values
Error message: brake	<ul style="list-style-type: none"> — Short-circuit in the supply voltage lead to the motor holding brake — Faulty motor holding brake 	<ul style="list-style-type: none"> — Remove the short-circuit — Replace motor
Error message: output stage fault	<ul style="list-style-type: none"> — Motor cable has short-circuit or earth short — Motor has short-circuit or earth short 	<ul style="list-style-type: none"> — Replace cable — Replace motor
Error message: resolver	<ul style="list-style-type: none"> — Resolver connector is not properly plugged in — Break in resolver cable, cable crushed or similar 	<ul style="list-style-type: none"> — Check connector — Check cables
Error message: motor temperature	<ul style="list-style-type: none"> — Motor thermostat has switched — Loose resolver connector or break in resolver cable 	<ul style="list-style-type: none"> — Wait until the motor has cooled down. Then investigate why the motor becomes so hot. — Check connector, replace resolver cable if necessary
Brake does not grip	<ul style="list-style-type: none"> — Required holding torque too high — Brake faulty — Motor shaft axially overloaded 	<ul style="list-style-type: none"> — Check the dimensioning — Replace motor — Check the axial load, reduce it. Replace motor, since the bearings have been damaged

IV.3 Index

A	Ambient temperature	8	S	Safety notes	4
	Assembly	17		Servo amplifier	8
	Axial force	9		Shielding	17
	Axial force, diagram	22		Site	17
B	Break response times	12		Standstill current	12
C	Commissioning	19		Standstill torque	12
	Connection method	10		Storage	33
	Coupling	9		Storage humidity	33
D	Delivery package	33		Storage temperature	33
	Dimensions	21		Storage time	33
	Disposal	33		Style	9
E	Earthing	17	T	Technical data 6SM27..107	13
	Encoder	10		Thermal time constant	12
F	Feedback unit	10		Thermostat	9
	Flange temperature	8		Torque constant	12
H	Holding brake	10		Transport	33
I	Insulation material class	10	V	Ventilation	17
M	Maintenance	33		Vibration class	10
	Manufacturer declaration	6		Voltage constant	12
	Motor lead	18	W	Wiring	17
O	Options	11		Wiring diagram	23
P	Peak current	12			
	Power derating	8			
	Protection class	9			
	Protective device	9			
R	Radial force	9			
	Radial force, diagram	22			
	Rated current	12			
	Rated torque	12			
	Resolver	10			
	Resolver lead	18			
	Rotor moment of inertia	12			

Sales and Service

We are committed to quality customer service. In order to serve in the most effective way, please contact your local sales representative for assistance.
If you are unaware of your local sales representative, please contact us.

Europe

Visit the European Danaher Motion web site at www.DanaherMotion.net for Setup Software upgrades, application notes, technical publications and the most recent version of our product manuals.

Danaher Motion Customer Support - Europe

Internet www.DanaherMotion.net
E-Mail support@danahermotion.net
Phone: +49(0)203 - 99 79 - 0
Fax: +49(0)203 - 99 79 - 155

North America

Visit the North American Danaher Motion web site at www.DanaherMotion.com for Setup Software upgrades, application notes, technical publications and the most recent version of our product manuals.

Danaher Motion Customer Support North America

Internet www.DanaherMotion.com
E-Mail customer.support@danahermotion.com
Phone: 1-540-633-3400
Fax: 1-540-639-4162